

TABLE OF CONTENTS

Custom Molded Cable Assemblies and Connectors	2
Capabilities	3
Standard Connector Products	4
Standard Connector Features	5
Micro-Con-X® Series (2 and 3 Contacts)	6
Dimensions	7
Part Number to Order & Contact Arrangement	8
Specifications	9
Mini-Con-X® Series (2 through 8 Contacts)	10
Dimensions	11
Part Number to Order & Contact Arrangement	12
Specifications	13
Multi-Con-X® Series (2 through 9 Contacts)	14
Dimensions	15
Part Number to Order & Contact Arrangement	16
Specifications	17
Maxi-Con-X® Series (Up to 20 Contacts)	18
Dimensions	19
Part Number to Order & Contact Arrangement	20
Specifications	21
Mega-Con-X® Series (Up to 31 Contacts)	22
Dimensions	23
Part Number to Order & Contact Arrangement	24
Specifications	25
Con-X Molded Cable Assembly Checklist	26
Con-X Current Rating Chart	27
Mil-E-Qual® Series (2 through 37 Contacts)	28
Dimensions	29
Contact Arrangement	30
Part Number to Order	31
Specifications	32
Mil-E-Qual® Molded Cable Assembly Checklist	33
Mil-E-Qual® Current Rating Chart	34
Tooling	34-35
Assembly Procedures	35

* Please visit the product pages on our website for the most up-to-date product information

CUSTOM MOLDED CABLE ASSEMBLIES AND CONNECTORS



CUSTOM MOLDED CABLE ASSEMBLIES AND CONNECTORS

Conxall History

Conxall was founded in 1971 as a manufacturer of custom designed connectors and cable assemblies for the Marine and Industrial Markets. Since that time our custom designed products have become the standard for many other industries and Conxall's family of products has grown to include waterproof, water-tight and submersible connectors and assemblies. In recent years, Conxall has expanded its all plastic product lines to include metal shell, shielded connectors and cable assemblies designed to meet or exceed U.S., Canadian, and European shielding standards.

Connectors

Conxall was an innovator in the design of all plastic cylindrical connectors. The all plastic connector provides for substantial savings in cost without sacrificing performance and quality. The all plastic connector is corrosion resistant, non-conductive and withstands substantial abuse, hostile environments, and heavy impacts that would otherwise cause metal connectors to corrode, deform or become electrically conductive and thus become unusable or unsafe. Our standard lines of all plastic connectors covers a wide range of shell styles and insert configurations including the all plastic Mil-C-5015 Connector series which is intermateable with, and provides a high quality replacement for, expensive, all metal, military standard connectors.

Assembly Capabilities

Conxall has specialized in custom molded cable assemblies and connectors for a wide variety of applications including: Industrial, Automotive, Marine, Transportation, Medical, Communication, Sensor and Factory Automation. The Conxall exclusive molded cable assembly process affords the additional advantages of reduced cost and weather tight reliability plus the added benefits of permanent and service free termination without the risk of cable pull out. Our SENSOR-LINK, Mini, Micro, and Nano style connectors and cable assemblies are NEMA rated, available in shielded and standard styles and are UL and CSA certified for many applications. For additional information on SENSOR-LINK products please contact your Conxall Representative.

Custom Designs

Conxall remains dedicated to providing High Quality, Low Cost solutions to your interconnect problems. Our Service Teams will work with you from the initial design to the finished product to insure your complete satisfaction. We offer a full line of standard and weather tight connectors. But perhaps your needs are unique. If so, Conxall has the capability to create original designs to meet your needs. Our team of engineers and research and development personnel will work side by side with your staff to custom design a solution for your needs.

Contact Conxall for your Interconnection Solutions. Our quick response and personalized service set Conxall apart from any other company in the industry.

STANDARD CONNECTOR PRODUCTS

Low-cost Standard and Weathertight Connectors for Industrial and Marine Applications.

A completely indoor/outdoor connector system that offers performance and reliability features of MIL-Spec connectors at the cost of a commercial type product.

Economical...The all molded nylon construction provides for substantial savings in cost that helps hold the line on cost objectives without sacrificing performance.

Standard Assemblies

Ideally satisfies power connections for test instruments, calibration or measuring equipment, communications systems, data processing, entertainment devices and a wide range of non-environmental applications where economy and maintenance-free reliability are essential. Especially suited to laboratory instruments, medical analysis devices, automotive test equipment, computer peripherals, recording instruments, etc....

Style...Designed for demanding service although attractive and modern in appearance to complement the most sophisticated equipment.

Lightweight/Strong...50% weight savings over similar metal construction yet has tough, high-impact strength to withstand hard abuse both indoors and outdoors.

Weathertight Assemblies

Optional panel connector gaskets and interfacial "O" ring seals maintain a weathertight connection for outdoor use. The non-corrosive, high impact, all molded construction is perfect for recreational, agricultural or on/off the road vehicle connections. Hazards of electrical shock are minimized in addition to resistance to hostile outdoor environment. Frequently specified for depth sounders, metal detectors, marine/aircraft electronics, boat trailers, electronic farm implements, food processing equipment, etc.

Molded Cable Assemblies (See pages 3 & 26)

Complete Facilities to Assemble and/or Mold All Connector Styles to Many Cable Constructions

Permanently Molded...Cable and connectors are molded together in a choice of attractive boot shapes to add functional improvements to your product.

Accident Proof...Molded encapsulation between cable and connector prevents pull-out or breakage of internal wires for maintenance free operation.

Weathertight...This construction prevents ingress of moisture into contact areas.

Saves Time and Money...Avoids setting up new production line and training personnel plus cost of maintaining inventories.

STANDARD CONNECTOR FEATURES

Panel Connector mounts from behind in round or “D” shaped hole and are securely fastened with hex nut on the front of the panel. Standard assembly include weathertight gasket.

Premium Quality The standard screw-machine socket contact has premium design features at low cost. The closed entry prevents probe damage or accidental loss of spring retention due to misaligned or bent pins.

Reverse Contact Options are available providing pin or socket contacts in all styles.

Locking Type coupling ring prevents accidental disconnect. Quick 90 degree connect/disconnect rotation or threaded.

Cable Splices and/or extension cables can be easily made using the cable to cable connectors.

Unassembled Cable Connectors without mold-on cables are available. This option provides for field installation or replacement service on existing cable assemblies.

Dimensions and Specifications are for reference only and may change without notice where it does not affect form, fit or function.

Electrical Rating Tables are for reference only and are based on continuous current carrying capacity of the connector with all contacts carrying current.

Packaging and Warranty

Packaging

Connectors: Standard Con-X series components are packaged unassembled and individually bulk packed. Kitted packaging, one complete connector per bag, available upon request for an additional cost. Mil-E-Qual components are assembled and individually kitted in plastic bags.

Cable Assemblies: Assemblies less than 3 ft., including connector head, are bundled and boxed. Assemblies over 3 ft., including connector head, are coiled, secured with cable tie and boxed.

Warranty

CONXALL Corp. manufactures the finest quality product available to the marketplace. However, these products are intended to be used in accordance with the specifications described in this catalog. Any use or application that deviates from the stated operating specifications is not recommended and **may be unsafe**. A limited warranty applies to all CONXALL Corp. products. Except for obligations specifically assumed by CONXALL Corp. under warranty, CONXALL Corp. will not be liable for any loss, damage, cost of repairs, incidental or consequential damages of any kind whether or not based upon expressed or implied warranty, contract, negligence, or strict liability arising in connection with the design, manufacture, sale, use or repair of the products.

* Please visit the product pages on our website for the most up-to-date product information

MICRO-CON-X[®] FIELD INSTALLABLE CONNECTORS



Cable Pin
1628X-XPB-XXX
Matching Mates:
• **Cable-Cable**
1828X-XSB-XXX
• **Panel**
172XX-XSB-XXX



Panel Mount
1728X-XXB-XXX
Matching Mates:
• **Cable Pin**
1628X-XPB-XXX
• **Cable Socket**
1628X-XSB-XXX



P/C Tail Panel Mount
172XX-XXB-XXX
Matching Mates:
• **Cable Pin**
1628X-XPB-XXX
• **Cable Socket**
1628X-XSB-XXX



Cable Socket
1628X-XSB-XXX
Matching Mates:
• **Cable-Cable**
1828X-XPB-XXX
• **Panel**
172XX-XPB-XXX



Cable to Cable
1828X-XXB-XXX
Matching Mates:
• **Cable Pin**
1628X-XPB-XXX
• **Cable Socket**
1628X-XSB-XXX



Dust Cap
16295

Molded Cable Assemblies (See pages 3 & 26)



Cable End



Cable to Cable



Right Angle

* Please visit the product pages on our website for the most up-to-date product information

MICRO-CON-X® FIELD INSTALLABLE CONNECTORS

Dimensions (Dimensions in brackets are in millimeters)



CABLE END CONNECTOR - WITH SNAP LOCK BACKSHELL (NON-REMOVABLE)



PANEL MOUNT CONNECTOR - SHOWN WITH HEX NUT AND GASKET



CABLE TO CABLE CONNECTOR - WITH SNAP LOCK BACKSHELL (NON-REMOVEABLE)

Molded Cable Assemblies (See pages 3 & 26)



CABLE END ASSEMBLY
STRAIGHT BOOT
0.280 [7.1] MAX. CABLE O.D.

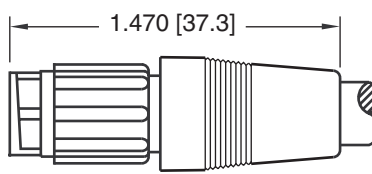

CABLE TO CABLE ASSEMBLY
STRAIGHT BOOT
0.280 [7.1] MAX. CABLE O.D.



CABLE END ASSEMBLY
90° BOOT
0.280 [7.1] MAX. CABLE O.D.

* Please visit the product pages on our website for the most up-to-date product information

MICRO-CON-X[®] FIELD INSTALLABLE CONNECTORS

Part Number to Order

XX X XX-XXG-3XX

Connector Type: _____

- 16 - Cable End
- 17 - Panel Mount
- 18 - Cable to Cable

Contact Size: _____

2 - #20

Contact Style: _____

- 80 - Crimp (Supplied loose)
- 81 - P/C Tail .187" (4.7) (Supplied assembled)
- 82 - Solder Cup (Supplied assembled)
- 91 - P/C Tail .280" (7.1) (Supplied assembled)*
- 92 - P/C Tail .335" (8.5) (Supplied assembled)*

Number of Contacts: _____

2 or 3

Type of Contact: _____

- P - Pin
- S - Socket

Contact Plating: _____

G - Gold over Nickel (Standard)

**Back Shell
Style 3**

Grommet Code –

Cable O.D. Range:

- 11 - .09 - .14 (2.3-3.5)
- 15 - .15 - .17 (3.8-4.3)
- 18 - .18 - .20 (4.6-5.1)

Back Shell Style:

- 3 - Weathertight Grommet
Grip/Seal & (1) interfacial
"O" Ring

**300 - Panel mount with hex nut
& gasket**

3ES - 300 with Epoxy

*Available in #20 size contact only.

Consult factory for optional threaded coupling.

Consult factory for your custom design cable assemblies and connectors. (See pages 3 & 26)

Contact Arrangements



2-#20

CABLE PIN, PANEL SOCKET
AND CABLE TO CABLE SOCKET ONLY

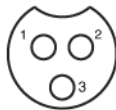

3-#20

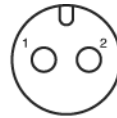

2-#20

CABLE SOCKET, PANEL PIN
AND CABLE TO CABLE PIN ONLY

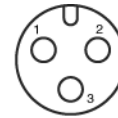

3-#20

Contact arrangements shown are wiring view of cable end pins/sockets.

Key/keyway shown for orientation only.

For higher density patterns, consult factory.

MICRO-CON-X[®] FIELD INSTALLABLE CONNECTORS

Specifications

Typical Specifications

Manufacturers Identifications	Micro-Con-X [®]
Description	Field Installable Connector & Custom Cable Assemblies
Rating	3.0 thru 7.5A, 600V
Conductor Size	20 thru 24 AWG
Configuration	2 & 3 #20 Contacts
Certification	UL Recognized File #E150822 - 250V CSA Certified File #181200 - 600V

Material Specifications

Cable Pin/Socket

Backshell (Non-Removable Snap Lock)	Nylon, UL Recognized, Black
Grommet	Santoprene Rubber, Black
Coupling Ring	Nylon, UL Recognized, Black
Contacts	Brass, Gold over Nickel
Connector Body	Nylon, UL Recognized, Black
O-Ring	Neoprene Rubber, Black

Cable to Cable

Backshell (Non-Removable Snap Lock)	Nylon, UL Recognized, Black
Grommet	Santoprene Rubber, Black
Contacts	Brass, Gold over Nickel
Connector Body	Nylon, UL Recognized, Black

Panel Mount

Contacts	Brass, Gold over Nickel
Panel Body	Nylon, UL Recognized, Black
Gasket	Neoprene Rubber, Black
Hex Nut	Nylon, UL Recognized, Black

Optional

Dust Cap	Santoprene Rubber, Black (Part No. 16295)
----------	---

Gasket, O-Ring, & Grommet materials are suitable for -40°C to +90°C (-40°F to +194°F). Consult factory for higher temperature requirements.

Mechanical Specifications

Durability	Minimum 300 mate/unmate cycles without mechanical or electrical failure
Vibration	Coupling rings have overriding locking feature to prevent loosening or separation of connector
Hex Nut Torque	All series hex nut to withstand 10-12 inch/lb tightening torque.

Electrical Specifications

Voltage	600 V
Current	See Electrical Current Rating Chart (Page 27)

Environmental Specifications

Temperature Rating	-40°C to +115°C (-40°F to +239°F)
Corrosion	300 Hr salt spray contacts
Weathertight	Consult factory with specific application

Molded Cable Assemblies

Watertight	(See Pages 3 & 26) NEMA 6P, 13: IEC IP67
------------	---

* Please visit the product pages on our website for the most up-to-date product information

MINI-CON-X® FIELD INSTALLABLE CONNECTORS



Cable Pin

6X8X-XPB-XXX

Matching Mates:

- Cable-Cable
8X8X-XSB-XXX
- Panel
7XXX-XSB-XXX



Panel Mount

7X8X-XXB-XXX

Matching Mates:

- Cable Pin
6X8X-XPB-XXX
- Cable Socket
6X8X-XSB-XXX



P/C Tail Panel Mount

7XXX-XXB-XXX

Matching Mates:

- Cable Pin
6X8X-XPB-XXX
- Cable Socket
6X8X-XSB-XXX



Cable Socket

6X8X-XSB-XXX

Matching Mates:

- Cable-Cable
8X8X-XPB-XXX
- Panel
7XXX-XPB-XXX



Cable to Cable

8X8X-XXB-XXX

Matching Mates:

- Cable Pin
6X8X-XPB-XXX
- Cable Socket
6X8X-XSB-XXX



Dust Cap

6295



Winged Coupling Ring

W/6482

Molded Cable Assemblies (See pages 3 & 26)



Cable End



Cable to Cable



Right Angle

MINI-CON-X® FIELD INSTALLABLE CONNECTORS

Dimensions (Dimensions in brackets are in millimeters)



CABLE END CONNECTOR
STYLE 5 LONG
TWIST LOCK BACKSHELL



CABLE END CONNECTOR
STYLE 3 AND 3DC SHORT
TWIST LOCK BACKSHELL



5/8 [15.9]-27 UNEF THREAD
1/32 TO 3/16 PANEL
[0.8 TO 4.8]

PANEL MOUNT CONNECTOR
SHOWN WITH HEX NUT AND GASKET



RECOMMENDED
PANEL CUT-OUT
±.003 [±0.1]



CABLE TO CABLE CONNECTOR
STYLE 5 LONG
TWIST LOCK BACKSHELL



CABLE TO CABLE CONNECTOR
STYLE 3 AND 3DC SHORT
TWIST LOCK BACKSHELL

Molded Cable Assemblies (See pages 3 & 26)



CABLE END ASSEMBLY
STRAIGHT BOOT
0.375 [9.5] MAX. CABLE O.D.



CABLE TO CABLE ASSEMBLY
STRAIGHT BOOT
0.375 [9.5] MAX. CABLE O.D.



CABLE END ASSEMBLY
90° BOOT
0.310 [7.9] MAX. CABLE O.D.

* Please visit the product pages on our website for the most up-to-date product information

MINI-CON-X® FIELD INSTALLABLE CONNECTORS

Part Number to Order

X X XX-XXG-XXX

Connector Type: _____
 6 - Cable End
 7 - Panel Mount
 8 - Cable to Cable

Contact Size: _____
 2 - #20 (2-8 Contacts)
 3 - #16 (2-5 Contacts)

Contact Style: _____
 80 - Crimp (Supplied loose)
 81 - P/C Tail .187" (4.7) (Supplied assembled)
 82 - Solder Cup (Supplied assembled)
 91 - P/C Tail .280" (7.1) (Supplied assembled)*
 92 - P/C Tail .335" (8.5) (Supplied assembled)*

Number of Contacts: _____
 2, 3, 4, 5, 6, 7 & 8

Type of Contact: _____
 P - Pin
 S - Socket

Contact Plating: _____
 G - Gold over Nickel (Standard)

Grommet Code – Cable O.D. Range:
11 - .09 - .14 (2.3 - 3.5)
15 - .15 - .17 (3.8 - 4.3)
18 - .18 - .20 (4.6 - 5.1)
21 - .21 - .23 (5.3 - 5.8)

Back Shell Style 3
13 - .13 - .15 (3.3 - 3.8)
16 - .16 - .18 (4.1 - 4.6)
19 - .19 - .21 (4.8 - 5.3)
22 - .22 - .25 (5.6 - 6.3)

Back Shell Style 5

Back Shell Style:
3 Weathertight grommet grip/seal & (1) interfacial "O" ring.
3DC - Daisy chain grommet with 3 I.D.s. (.125, .188 & .250)
5 Long back shell with extended grommet & cable grip. Use with crimp or solder.

300 - Panel mount with hex nut & gasket.
3ES - 300 with Epoxy

*Available in #20 size contact only.

Consult factory for optional threaded coupling.

Consult factory for your custom design cable assemblies and connectors. (See pages 3 & 26)

Contact Arrangements



Contact arrangements shown are wiring view of cable end pins/sockets.

Key/keyway shown for orientation only.

*Available in connector types: cable end socket, panel mount pin, and cable to cable pin styles only.

MINI-CON-X[®] FIELD INSTALLABLE CONNECTORS

Specifications

Typical Specifications

Manufacturers Identifications	Mini-Con-X [®]
Description	Field Installable Connector & Custom Cable Assemblies
Rating	4.8 thru 13.0A, 600V
Conductor Size	#16 contacts, 16 thru 18 AWG #20 contacts, 20 thru 24 AWG
Configuration	2 thru 5 #16 Contacts or 2 thru 8 #20 Contacts
Certification	UL Recognized File #E150822 - 250V CSA Certified File #181200 - 600V

Material Specifications

Cable Pin/Socket

Backshell (Removable Twist Lock)	Nylon, UL Recognized, Black
Grommet	Santoprene Rubber, Black
Coupling Ring	Nylon, UL Recognized, Black
Contacts	Brass, Gold over Nickel
Connector Body	Nylon, UL Recognized, Black
O-Ring	Neoprene Rubber, Black

Optional

Long Backshell (Removable Twist Lock)	Nylon, UL Recognized, Black (Style #5)
Winged Coupling Ring	Nylon, UL Recognized, Black (W/6482)

Cable to Cable

Backshell (Removable Twist Lock)	Nylon, UL Recognized, Black
Grommet	Santoprene Rubber, Black
Contacts	Brass, Gold over Nickel
Connector Body	Nylon, UL Recognized, Black

Panel Mount

Contacts	Brass, Gold over Nickel
Panel Body	Nylon, UL Recognized, Black
Gasket	Neoprene Rubber, Black
Hex Nut	Nylon, UL Recognized, Black

Optional

Dust Cap	Santoprene Rubber, Black (Part No. 6295)
----------	--

Gasket, O-Ring, & Grommet materials are suitable for -40°C to +90°C (-40°F to +194°F). Consult factory for higher temperature requirements.

Mechanical Specifications

Durability	Minimum 300 mate/unmate cycles without mechanical or electrical failure
Vibration	Coupling rings have overriding locking feature to prevent loosening or separation of connector
Hex Nut Torque	All series hex nut to withstand 10-12 inch/lb tightening torque.

Electrical Specifications

Voltage	600 V
Current	See Electrical Current Rating Chart (Page 27)

Environmental Specifications

Temperature Rating	-40°C to +115°C (-40°F to +239°F)
Corrosion	300 Hr salt spray contacts
Weathertight	Consult factory with specific application

Molded Cable Assemblies

Watertight	(See Pages 3 & 26) NEMA 6P, 13: IEC IP67
------------	---

* Please visit the product pages on our website for the most up-to-date product information

MULTI-CON-X® FIELD INSTALLABLE CONNECTORS



Cable Pin
3X8X-XPB-XXX
Matching Mates:

- Cable-Cable
5X8X-XSB-XXX
- Panel
4XXX-XSB-XXX



Panel Mount
4X8X-XXB-XXX
Matching Mates:

- Cable Pin
3X8X-XPB-XXX
- Cable Socket
3X8X-XSB-XXX



P/C Tail Panel Mount
4XXX-XXB-XXX
Matching Mates:

- Cable Pin
3X8X-XPB-XXX
- Cable Socket
3X8X-XSB-XXX



Cable Socket
3X8X-XSB-XXX
Matching Mates:

- Cable-Cable
5X8X-XPB-XXX
- Panel
4XXX-XPB-XXX



Cable to Cable
5X8X-XXB-XXX
Matching Mates:

- Cable Pin
3X8X-XPB-XXX
- Cable Socket
3X8X-XSB-XXX



Mechanical Back Shell
(Style #5)



Square Flange Adapter
4296



Square Flange Gasket
4297



Dust Cap
4295



Winged Coupling Ring
W/4482

Molded Cable Assemblies (See pages 3 & 26)



Cable End



Cable to Cable



Right Angle

* Please visit the product pages on our website for the most up-to-date product information

MULTI-CON-X® FIELD INSTALLABLE CONNECTORS

Dimensions (Dimensions in brackets are in millimeters)



Molded Cable Assemblies (See pages 3 & 26)



MULTI-CON-X® FIELD INSTALLABLE CONNECTORS

Part Number to Order

<p style="text-align: center; font-weight: bold; font-size: 1.2em;">X X XX-X XG-XXX</p> <p>Connector Type: _____</p> <p>3 - Cable End 4 - Panel Mount 5 - Cable to Cable</p> <p>Contact Size: _____</p> <p>1 - #12 (2-4 Contacts) 2 - #20 (4-9 Contacts) 3 - #16 (4-6 Contacts)</p> <p>Contact Style: _____</p> <p>80 - Crimp (Supplied loose) 81 - P/C Tail .187" (4.7) (Supplied assembled) 82 - Solder Cup (Supplied assembled) 91 - P/C Tail .280" (7.1) (Supplied assembled)* 92 - P/C Tail .335" (8.5) (Supplied assembled)*</p> <p>Number of Contacts: _____</p> <p>2, 3, 4, 5, 6, 7, 8 & 9</p> <p>Type of Contact: _____</p> <p>P - Pin S - Socket</p> <p>Contact Plating: _____</p> <p>G - Gold over Nickel (Standard)</p>	<p>Back Shell Style 3 or 5</p> <p>Back Shell Style:</p> <p>3 Weathertight grommet grip/seal & (1) interfacial "O"ring.</p> <p>3DC - Daisy chain grommet with 3 I.D.s (.125, .188 & .250)</p> <p>5 Mechanical screw-down cable clamp with grommet seal.</p>	<p>Grommet Code – Cable O.D. Range:</p> <p>15 - .15 - .17 (3.8-4.3) 18 - .18 - .20 (4.6-5.1) 21 - .21 - .23 (5.3-5.8) 24 - .24 - .27 (6.1-6.8) 28 - .28 - .29 (7.1-7.4) 30 - .30 - .32 (7.6-8.1)</p> <p>300 - Panel mount with hex nut & gasket.</p> <p>3ES - 300 with Epoxy (Panel Mount Only)</p>
---	--	--

EMI/RFI shielded assemblies available - consult factory.
 *Available in #20 size contact only.
Consult factory for optional threaded coupling.
Consult factory for your custom design cable assemblies and connectors. (See pages 3 & 26)

Contact Arrangements



Contact arrangements shown are wiring view of cable end pins/sockets.

Key/keyway shown for orientation only.

*Available in connector types: cable end socket, panel mount pin, and cable to cable pin styles only.

MULTI-CON-X® FIELD INSTALLABLE CONNECTORS

Specifications

Typical Specifications

Manufacturers Identifications	Multi-Con-X®
Description	Field Installable Connector & Custom Cable Assemblies
Rating	1.95 thru 23.0A, 600V
Conductor Size	#12 Contacts, 12 thru 14 AWG #16 Contacts, 16 thru 18 AWG #20 Contacts, 20 thru 24 AWG
Configuration	2 thru 4 #12 Contacts 4 thru 6 #16 Contacts 4 thru 9 #20 Contacts
Certification	UL Recognized File #E150822 - 250V CSA Certified File #181200 - 600V

Material Specifications

Cable Pin/Socket

Backshell (Threaded)	Nylon, UL Recognized, Black (Style #3)
Grommet	Santoprene Rubber, Black
Coupling Ring	Nylon, UL Recognized, Black
Contacts	Brass, Gold over Nickel
Connector Body	Nylon, UL Recognized, Black
O-Ring	Neoprene Rubber, Black
Sleeve	Nylon, UL Recognized, Black

Cable to Cable

Backshell (Threaded)	Nylon, UL Recognized, Black (Style #3)
Grommet	Santoprene, Rubber, Black
Contacts	Brass, Gold over Nickel
Connector Body	Nylon, UL Recognized, Black

Optional

Long Backshell (Threaded)	Nylon, UL Recognized, Black (Style #3 with solder contacts)
Winged Coupling Ring	Nylon, UL Recognized, Black (W/4482)
Mechanical Backshell (Threaded)	Nylon, UL Recognized, Black (Style #5)
- Strap	Nylon, UL Recognized, Black
- Screws	Stainless Steel

Panel Mount

Contacts	Brass, Gold over Nickel
Panel Body	Nylon, UL Recognized, Black
Gasket	Neoprene Rubber, Black
Hex Nut	Nylon, UL Recognized, Black

Optional

Dust Cap	Santoprene Rubber, Black (Part No. 4295)
Square Flange Adapter	Nylon, UL Recognized, Black (Part No. 4296)
Square Flange Adapter Gasket	Neoprene Rubber, Black (Part No. 4297)

Gasket, O-Ring, & Grommet materials are suitable for -40°C to +90°C (-40°F to +194°F). Consult factory for higher temperature requirements.

Mechanical Specifications

Durability	Minimum 300 mate/unmate cycles without mechanical or electrical failure
Vibration	Coupling rings have overriding locking feature to prevent loosening or separation of connector
Hex Nut Torque	All series hex nut to withstand 10-12 inch/lb tightening torque.

Electrical Specifications

Voltage	600 V
Current	See Electrical Current Rating Chart (Page 27)

Environmental Specifications

Temperature Rating	-40°C to +115°C (-40°F to +239°F)
Corrosion	300 Hr salt spray contacts
Weathertight	Consult factory with specific application (See Pages 3 & 26)
Molded Cable Assemblies	NEMA 6P, 13; IEC IP67
Watertight	

MAXI-CON-X[®] FIELD INSTALLABLE CONNECTORS



Cable Pin
13X8X-XXPG-XXX
Matching Mates:

- **Cable-Cable**
15X8X-XXSG-XXX
- **Panel**
14XXX-XXSG-XXX



Panel Mount
14X8X-XXXG-XXX
Matching Mates:

- **Cable Pin**
13X8X-XXPG-XXX
- **Cable Socket**
13X8X-XXSG-XXX



P/C Tail Panel Mount
14XXX-XXXG-XXX
Matching Mates:

- **Cable Pin**
13X8X-XXPG-XXX
- **Cable Socket**
13X8X-XXSG-XXX



Cable Socket
13X8X-XXSG-XXX
Matching Mates:

- **Cable-Cable**
15X8X-XXPG-XXX
- **Panel**
14XXX-XXPG-XXX



Cable to Cable
15X8X-XXXG-XXX
Matching Mates:

- **Cable Pin**
13X8X-XXPG-XXX
- **Cable Socket**
13X8X-XXSG-XXX



Winged Coupling Ring
W/14482



Dust Cap
14295

Molded Cable Assemblies (See pages 3 & 26)



Cable End



Cable to Cable



Right Angle

* Please visit the product pages on our website for the most up-to-date product information

MAXI-CON-X® FIELD INSTALLABLE CONNECTORS

Dimensions (Dimensions in brackets are in millimeters)



Molded Cable Assemblies (See pages 3 & 26)



MAXI-CON-X® FIELD INSTALLABLE CONNECTORS

Part Number to Order

XX X XX-XX XG-3XX

Connector Type: _____

- 13 - Cable End
- 14 - Panel Mount
- 15 - Cable to Cable

Contact Size: _____

- 1 - #12 (7 Contacts)
- 2 - #20 (18 & 20 Contacts)
- 3 - #16 (10 Contacts)

Contact Style: _____

- 80 - Crimp (Supplied loose)
- 81 - P/C Tail .187" (4.7) (Supplied assembled)
- 82 - Solder Cup (Supplied assembled)
- 91 - P/C Tail .280" (7.1) (Supplied assembled)*
- 92 - P/C Tail .335" (8.5) (Supplied assembled)*

Number of Contacts: _____

- 7, 10, 18 & 20

Type of Contact: _____

- P - Pin
- S - Socket

Contact Plating: _____

- G - Gold over Nickel (Standard)

EMI/RFI shielded assemblies available - consult factory.

*Available in #20 size contact only.

Consult factory for optional threaded coupling.

Consult factory for your custom design cable assemblies and connectors. (See pages 3 & 26)

Grommet Code – Cable O.D. Range:
Back Shell Style 3
 21 - .21 - .25 (5.3-6.3)
 26 - .26 - .30 (6.6-7.6)
 31 - .31 - .38 (7.8-9.6)

Back Shell Style:
 3 Mechanical screw-down cable clamp with grommet seal and (1) interfacial "O" ring for cable end.

300 - Panel mount with hex nut & gasket.

3ES - 300 with Epoxy

Contact Arrangements



Contact arrangements shown are wiring view of cable end pins/sockets.

Key/keyway shown for orientation only.

*Available in connector types: cable end socket, panel mount pin styles only.

MAXI-CON-X® FIELD INSTALLABLE CONNECTORS

Specifications

Typical Specifications

Manufacturers Identifications	Maxi-Con-X®
Description	Field Installable Connector & Custom Cable Assemblies
Rating	1.35 thru 23.0A, 600V
Conductor Size	#12 Contacts, 12 thru 14 AWG #16 Contacts, 16 thru 18 AWG #20 Contacts, 20 thru 24 AWG
Configuration	7 - #12 Contacts 10 - #16 Contacts 18 - #20 Contacts 20 - #20 Contacts
Certification	UL Recognized File #E150822 - 250V CSA Certified File #181200 - 600V

Material Specifications

Cable Pin/Socket

Mechanical Backshell (Threaded)	Nylon, UL Recognized, Black
Strap	Nylon, UL Recognized, Black
Screws	Stainless Steel
Grommet	Santoprene Rubber, Black
Coupling Ring	Nylon, UL Recognized, Black
Contacts	Brass, Gold over Nickel
Connector Body	Nylon, UL Recognized, Black
O-Ring	Neoprene Rubber, Black

Optional

Winged Coupling Ring	Nylon, UL Recognized, Black (W/14482)
----------------------	---------------------------------------

Cable to Cable

Mechanical Backshell (Threaded)	Nylon, UL Recognized, Black
Grommet	Santoprene Rubber, Black
Strap	Nylon, UL Recognized, Black
Screws	Stainless Steel
Contacts	Brass, Gold over Nickel
Connector Body	Nylon, UL Recognized, Black

Panel Mount

Contacts	Brass, Gold over Nickel
Panel Body	Nylon, UL Recognized, Black
Gasket	Neoprene Rubber, Black
Hex Nut	Nylon, UL Recognized, Black

Optional

Dust Cap	Santoprene Rubber, Black (Part No. 14295)
----------	---

Gasket, O-Ring, & Grommet materials are suitable for -40°C to +90°C (-40°F to +194°F). Consult factory for higher temperature requirements.

Mechanical Specifications

Durability	Minimum 300 mate/unmate cycles without mechanical or electrical failure
Vibration	Coupling rings have overriding locking feature to prevent loosening or separation of connector
Hex Nut Torque	All series hex nut to withstand 10-12 inch/lb tightening torque

Electrical Specifications

Voltage	600 V
Current	See Electrical Current Rating Chart (Page 27)

Environmental Specifications

Temperature Rating	-40°C to +115°C (-40°F to +239°F)
Corrosion	300 Hr salt spray contacts
Weathertight	Consult factory with specific application

Molded Cable Assemblies

Watertight	(See Pages 3 & 26) NEMA 6P, 13; IEC IP67
------------	---

* Please visit the product pages on our website for the most up-to-date product information

MEGA-CON-X® FIELD INSTALLABLE CONNECTORS



Cable Pin
23X8X-XXPG-XXX
Matching Mate:
• **Panel**
24XXX-XXSG-XXX



Panel Mount
24XXX-XXXG-XXX
Matching Mates:
• **Cable Pin**
23X8X-XXPG-XXX
• **Cable Socket**
23X8X-XXSG-XXX



Cable Socket
23X8X-XXSG-XXX
Matching Mate:
• **Panel**
24XXX-XXPG-XXX



P/C Tail Panel Mount
24XXX-XXXG-XXX
Matching Mates:
• **Cable Pin**
23X8X-XXPG-XXX
• **Cable Socket**
23X8X-XXSG-XXX



Dustcap
24295

Molded Cable Assemblies (See pages 3 & 26)



Cable End



Right Angle

MEGA-CON-X® FIELD INSTALLABLE CONNECTORS

Quick Connect Type

Threaded Type

Dimensions (Dimensions in brackets are in millimeters)



Panel Cutout



Molded Cable Assemblies (See pages 3 & 26)



* Please visit the product pages on our website for the most up-to-date product information

MEGA-CON-X® FIELD INSTALLABLE CONNECTORS

Part Number to Order



*Available in #20 size contact only.
 Consult factory for your custom design cable assemblies and connectors. (See pages 3 & 26)

Contact Arrangements



Contact arrangements shown are wiring view of cable end pins/sockets.
 Key/keyway shown for orientation only.

MEGA-CON-X® FIELD INSTALLABLE CONNECTORS

Specifications

Typical Specifications

Manufacturers Identifications	Mega-Con-X®
Description	Field Installable Connector & Custom Cable Assemblies
Rating	0.9 thru 2.3A, 600V
Conductor Size	20 thru 24 AWG
Configuration	31 - #20 Contacts
Certification	UL Recognized File #E150822 - 250V CSA Certified File #181200 - 600V

Material Specifications

Cable Pin/Socket

Mechanical Backshell (Threaded)	Nylon, UL Recognized, Black
Strap	Nylon, UL Recognized, Black
Screws	Stainless Steel
Grommet	Santoprene Rubber, Black
Coupling Ring	Nylon, UL Recognized, Black
Contacts	Brass, Gold over Nickel
Connector Body	Nylon, UL Recognized, Black
O-Ring	Neoprene Rubber, Black

Panel Mount

Contacts	Brass, Gold over Nickel
Panel Body	Nylon, UL Recognized, Black
Gasket	Neoprene Rubber, Black
Hex Nut	Nylon, UL Recognized, Black

Gasket, O-Ring, & Grommet materials are suitable for -40°C to +90°C (-40°F to +194°F). Consult factory for higher temperature requirements.

Mechanical Specifications

Durability	Minimum 300 mate/unmate cycles without mechanical or electrical failure
Vibration	Coupling rings have overriding locking feature to prevent loosening or separation of connector
Hex Nut Torque	All series hex nut to withstand 10-12 inch/lb tightening torque

Electrical Specifications

Voltage	600V
Current	See Electrical Current Rating Chart (Page 27)

Environmental Specifications

Temperature Rating	-40°C to +115°C (-40°F to +239°F)
Corrosion	300 Hr salt spray contacts
Weathertight	Consult factory with specific application

Molded Cable Assemblies

Watertight	(See Pages 3 & 26) NEMA 6P, 13: IEC IP67
------------	---

* Please visit the product pages on our website for the most up-to-date product information

CON-X MOLDED CABLE ASSEMBLY CHECK LIST

Company Name: _____ Customer Name: _____

Address: _____

City _____ State: _____ Zip: _____

Phone: _____ Fax: _____

Website: _____ E-mail: _____

Annual Usage Quantity: _____ Monthly Usage Quantity: _____

Does the assembly need to be RoHS compliant? Yes: _____ No: _____

Cable Vendor and Part Number (if available): _____

Cable Outer Jacket - Color: _____ Material: _____ OD: _____

Number of Conductors: _____ Conductor AWG: _____ Stranding: _____

Conductor Colors: _____

Is there a drain wire? _____ Is the drain wire terminated? _____

*If the drain wire is terminated, be sure to indicate where on pin-out diagram.

Is the cable shielded? _____ How? Foil _____ Braid _____ %

*If the shield is braided, be sure to indicate where on the pin-out diagram.

Will the Customer supply the cable for production? _____

Cable Cut Length: _____ Overall Assembly Length: _____

Does the Cable Assembly have Environmental Requirements? _____

If yes, please list them: _____

Must overmold have a moisture bond to the cable's outer jacket? _____

Is the Cable Assembly: Single ended: _____ Double Ended: _____

Do the connectors need to be shielded? _____

If yes, do they need to be: 180° shield: _____ OR Shield thru pin: _____

End "A" Connector Part Number: _____ Right Angle? _____

End "B", will that end need processing? _____ If yes, indicate below: _____

Outer jacket strip length: _____ Inner Conductor strip length: _____ Tinned? _____

Does end "B" have any special inclusions? If yes, please list them: _____

Note: Please submit a diagram of the color code pin-out, showing which conductors are wired to which pin position. Be sure to show drain and shield terminations, if needed. Indicate empty pins or spaces to be molded closed where required. If a drawing assembly is available, please send it also.

CON-X ELECTRICAL CURRENT RATING CHART FOR CONNECTORS & CABLE ASSEMBLIES

CONTACT SIZE	CONDUCTOR SIZE - AWG	NUMBER of CONDUCTORS	CURRENT RATING
#12	#12	1 through 7	23.0A
	#14	1 through 3	17.0A
		4 through 6	12.75A
		7 through 9	11.0A
	#16	1 through 3	13.0A
		4 through 6	9.75A
		7	8.45A
#16	#16	1 through 10	13.0A
		11 and 12	7.5A
	#18	1 through 3	10.0A
		4 through 12	7.5A
#20	#18	1 through 3	7.5A
		4 through 20	5.6A
		21 through 31	2.3A
	#20	1 through 3	7.5A
		4 through 20	5.6A
		21 through 31	2.3A

Max. Number and Size of Contacts per Series:

- 4 - #12 Multi-Con-X
- 7 - #12 Maxi-Con-X
- 5 - #16 Mini-Con-X
- 6 - #16 Multi-Con-X
- 12 - #16 Maxi-Con-X
- 3 - #20 Micro-Con-X
- 8 - #20 Mini-Con-X
- 9 - #20 Multi-Con-X
- 20 - #20 Maxi-Con-X
- 31 - #20 Mega-Con-X

* Please visit the product pages on our website for the most up-to-date product information

MIL-E-QUAL® EQUIVALENT TO MIL-C-5015



Cable Socket
CXX 3106A XXXX XX S XXX



Box Receptacle Pin
CXX 3102A XXXX XX P XXX



Cable Pin
CXX 3106A XXXX XX P XXX



Box Receptacle Socket
CXX 3102A XXXX XX S XXX



Cable Cap
4XX96



Receptacle Cap
4XX95

Molded Cable Assemblies (See pages 3 & 33)



Cable Pin

MIL-E-QUAL® EQUIVALENT TO MIL-C-5015

Connector Size	L	N	Q	V Fitting Threads
	INCH MM	INCH MM	INCH MM	
10SL	1.800 45.7	1.200 30.5	.900 22.9	1/2-20
12S	1.900 48.3	1.200 30.5	1.000 25.4	5/8-24
14S	1.900 48.3	1.300 33	1.200 30.5	3/4-20
16S	2.200 56.	1.425 36.2	1.250 31.8	7/8-20
16	2.400 61.	1.425 36.2	1.250 31.8	7/8-20
18	2.570 65.3	1.425 36.2	1.420 36.1	1-20
20	2.450 62.2	1.425 36.2	1.450 36.8	1-1/8-18
22	2.450 62.2	1.425 36.2	1.600 40.6	1-1/4-18
24	2.570 65.3	1.425 36.2	1.725 43.8	1-3/8-18
28	2.570 65.3	1.425 36.2	1.975 50.2	1-5/8-18

Connector Size	A Coupling Threads	K	L	M	R	S	C	Z
		Inch MM	Inch MM	Inch MM	Inch MM	Inch MM	Inch MM	Inch MM
10SL	5/8-24	.080 2	.940 23.9	9/16 14.3	23/32 18.3	1 25.4	3.5 88.9	.635 16.1
12S	3/4-20	.080 2	1.030 26.2	9/16 14.3	13/16 20.6	1-3/32 27.8	3.5 88.9	.760 19.3
14S	7/8-20	.080 2	1.143 29	9/16 14.3	29/32 23	1-3/16 30.2	3.5 88.9	.885 22.5
16S	1-20	.142 3.6	1.180 30	9/16 14.3	31/32 24.6	1-9/32 32.5	3.5 88.9	1.010 25.7
16	1-20	.142 3.6	1.350 34.3	3/4 19	31/32 24.6	1-9/32 32.5	3.5 88.9	1.010 25.7
18	1-1/8-18	.142 3.6	1.330 33.8	3/4 19	1-1/16 27	1-3/8 34.9	5.0 127.0	1.135 28.8
20	1-1/4-18	.142 3.6	1.330 33.8	3/4 19	1-5/32 29.4	1-1/2 38.1	5.0 127.0	1.260 32.0
22	1-3/8-18	.142 3.6	1.220 31.0	3/4 19	1-1/4 31.8	1-5/8 41.3	5.0 127.0	1.385 35.2
24	1-1/2-18	.142 3.6	1.220 31.0	13/16 20.6	1-3/8 34.9	1-3/4 44.5	6.0 152.4	1.510 38.4
28	1-3/4-18	.142 3.6	1.220 31.0	13/16 20.6	1-9/16 39.7	2 50.8	6.0 152.4	1.760 44.7

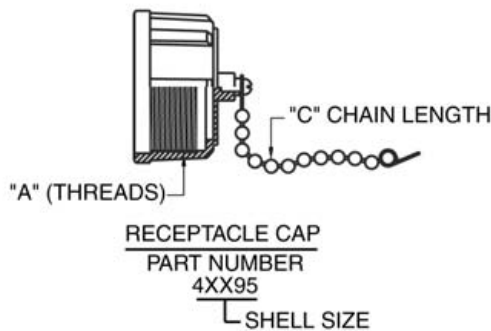
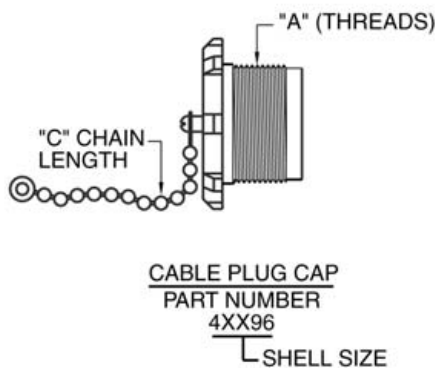
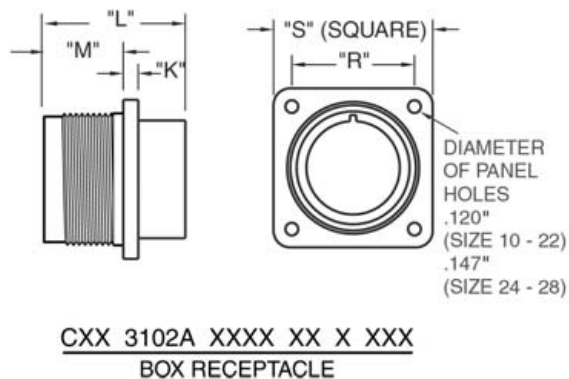

MIL-E-QUAL® EQUIVALENT TO MIL-C-5015

Contact Arrangements

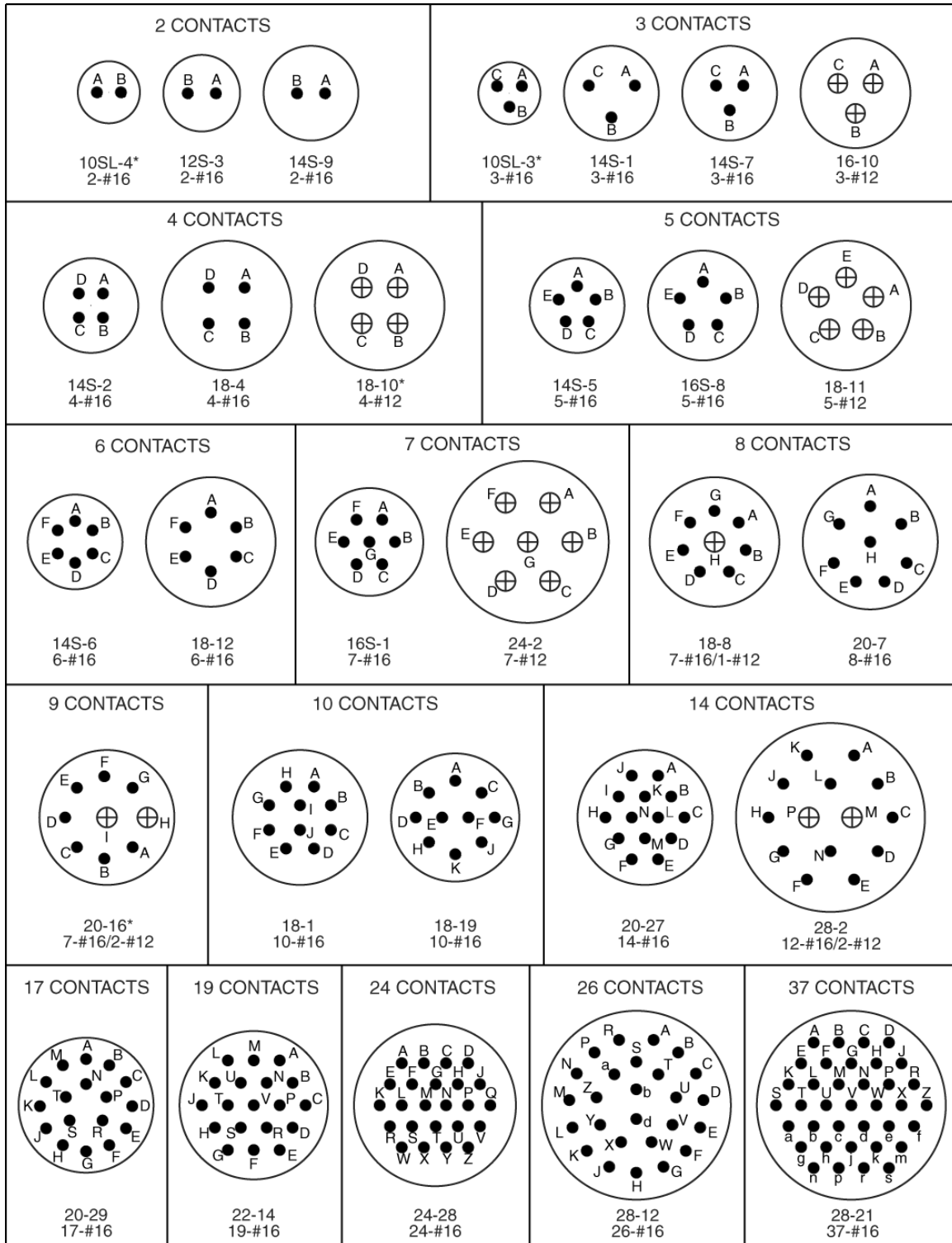

Contact Arrangements shown are mating view of pin insert (socket opposite).

Unless otherwise specified, arrangements are per MIL-STD-1651A. for alternate key positions, consult factory.

*Available in connector types: cable end socket, panel mount pin styles only.

MIL-E-QUAL® EQUIVALENT TO MIL-C-5015

Part Number to Order

CX X 310XA XXXX XX X XXX

CONXALL

Molded Equivalent to MIL-C-5015

Contact Style

S - Solder
C - Crimp

Shell Type

(See Note 1)

3101A Cable Receptacle (in-line)
(See Note 3)

3102A Box Receptacle

3106A Straight Plug (See Note 2)

Note 1 - All plugs and receptacles include crimp or solder contacts specified.

Note 2 - Straight Plugs include back shell assembly with cable clamp and bushing.

Note 3 - For overmolded cable construction only. Consult factory for availability.

Deviations

-300 Weathertight
Option adds:
"O" Ring for plug (3106A)
Rubber Gasket for receptacle (3102A)

-010 Receptacle with (4) mounting hole reinforcement bosses. Consult factory for availability.

-310 Same as -010 except with rubber gasket.

Contacts

P - Pin
S - Socket

Insert Number/Arrangement

All inserts are integrally molded with connector shells for one piece construction. Contact factory for alternative W, X, Y or Z insert positions.

Shell/Insert Sizes

10SL-4	16S-1	18-19
10SL-3	16S-8	20-7
12S - 3	16 - 10	20-16
14S - 1	18 - 1	20-27
14S - 2	18 - 4	20-29
14S - 5	18 - 8	22-14
14S - 6	18 - 10	24-2
14S - 7	18 - 11	24-28
14S - 9	18 - 12	28-2
		28-12
		28-21

Bushing Sizes Provided

Plug Shell Size	Max. Cable Dia.
10SL, 12S	1/4"
14S	5/16"
16S, 16	7/16"
18	9/16"
20, 22	5/8"
24, 28	3/4"

Consult factory for your custom design assemblies and connectors. (See pages 3 & 33)

MIL-E-QUAL® EQUIVALENT TO MIL-C-5015

Specifications

Typical Specifications

Manufacturers Identifications	MIL-E-QUAL®
Description	Field Installable Connector & Custom Cable Assemblies
Rating	3.4 thru 23.0A, 600V
Conductor Size	12 thru 20 AWG
Configuration	2 thru 37 Contacts per Mil - C-5015
Certification	UL Recognized File #E150822 - 250V CSA Certified File #181200-500V

Material Specifications

Cable Pin/Socket

Mechanical Backshell (Threaded)	Nylon, UL Recognized, Black with UV Inhibitor
Strap	Nylon, UL Recognized, Black with UV Inhibitor
Screws	Zinc Plated
Grommet	Santoprene Rubber, Black
Coupling Ring	Nylon, UL Recognized, Black with UV Inhibitor
Contacts	Brass, Standard Silver Plated, Gold Plated Optional
Connector Body	Nylon, UL Recognized, Black with UV Inhibitor

Optional

Connector Cap	Nylon, UL Recognized, Black with UV Inhibitor (4XX96)
O-Ring	Neoprene Rubber, Black

Different Keyways Available

Gold Contacts	Brass, Gold over Nickel
---------------	-------------------------

Box Receptacle

Contacts	Brass, Standard Silver Plated, Gold Plated Optional
Receptacle Body	Nylon, UL Recognized, Black with UV Inhibitor

Optional

Receptacle Cap	Nylon, UL Recognized, Black with UV Inhibitor (4XX95)
Gasket	Neoprene Rubber, Black
Gold Contacts	Brass, Gold over Nickel

Extended Bosses
Different Keyways Available

Gasket, O-Ring, & Grommet materials are suitable for -40°C to +90°C (-40°F to +194°F). Consult factory for higher temperature requirements.

Electrical Specifications

Voltage	500 V
Current	See Electrical Current Rating Chart (Page 34)

Environmental Specifications

Temperature Rating	-40°C to +125°C (-40°F to +257°F)
Corrosion	48 Hr salt spray contacts
Durability	300 mate/unmate cycles minimum
Weathertight	Consult factory with specific application

Molded Cable Assemblies

Watertight	(See Pages 3 & 33) NEMA 6P, 13: IEC IP67
------------	---

MIL-E-QUAL® MOLDED CABLE ASSEMBLY CHECK LIST

EQUIVALENT TO MIL-C-5015

Company Name: _____ Customer Name: _____

Address: _____

City _____ State: _____ Zip: _____

Phone: _____ Fax: _____

Website: _____ E-mail: _____

Annual Usage Quantity: _____ Monthly Usage Quantity: _____

Does the assembly need to be RoHS compliant? Yes: _____ No: _____

Cable Vendor and Part Number (if available): _____

Cable Outer Jacket - Color: _____ Material: _____ OD: _____

Number of Conductors: _____ Conductor AWG: _____ Stranding: _____

Conductor Colors: _____

Is there a drain wire? _____ Is the drain wire terminated? _____

*If the drain wire is terminated, be sure to indicate where on pin-out diagram.

Is the cable shielded? _____ How? Foil _____ Braid _____ % _____

*If the braid is terminated, be sure to indicate where on the pin-out diagram.

Will the Customer supply the cable for production? _____

Cable Cut Length: _____ Overall Assembly Length: _____

Does the Cable Assembly have Environmental Requirements? _____

If yes, please list them: _____

Must overmold have a moisture bond to the cable's outer jacket? _____

Is the Cable Assembly: Single ended: _____ Double Ended: _____

Do the connectors need to be shielded? _____

If yes, do they need to be: 180° shield: _____ OR Shield thru pin: _____

End "A" Connector Part Number: _____ Right Angle? _____

End "B" Connector Part Number: _____ Right Angle? _____

If no conductor on end "B", will that need processing? _____ If yes, indicate below:

Outer jacket strip length: _____ Inner Conductor strip length: _____ Tinned? _____

Does end "B" have any special inclusions? If yes, please list them: _____

Note: Please submit a diagram of the color code pin-out, showing which conductors are wired to which pin position. Be sure to show drain and shield terminations, if needed. Indicate empty pins or spaces to be molded closed where required. If a drawing assembly is available, please send it also.

MIL-E-QUAL® ELECTRICAL CURRENT RATING CHART FOR CONNECTORS & CABLE ASSEMBLIES

Contact Size	Conductor Size - AWG	Number of Conductors	Current Rating
#12	#12	1 through 3	23.0A
		4 through 6	17.0A
		7 through 9	13.0A
	#14	1 through 3	17.0A
		4 through 6	12.75A
		7 through 9	11.0A
#16	1 through 3	13.0A	
	4 through 6	9.75A	
	7 through 9	8.45A	
#16	#16	1 through 3	13.0A
		4 through 6	9.75A
		7 through 10	8.45A
		10 through 20	5.85A
		21 through 30	4.55A
		31 and up	3.9A
	#18	1 through 3	10.0A
		4 through 6	7.5A
		7 through 9	6.5A
		10 through 20	4.5A
		21 through 30	3.5A
		31 and up	3.0A
#20	1 through 3	7.5A	
	4 through 6	5.6A	
	7 through 9	4.8A	
	10 through 20	3.4A	
	21 through 30	2.62A	
	31 and up	2.3A	

TOOLING

Contact Insertion & Removal Tools



356-XXX Bits



356-1 Handle

Manual Crimp Tool
(Multi-contact)

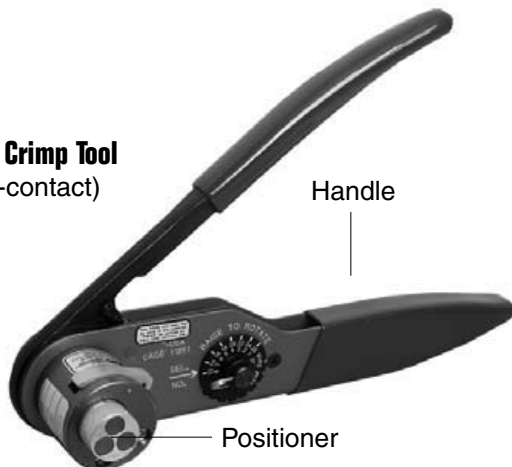

Handle

Positioner

Manual Crimp Tool
(Single Purpose)



Locator

Handle

TOOLING

Contact Insertion/Removal Tools

Con-X Series	Connector Size	Contact Size	Insertion Bits Pins or Sockets	Handle for Bits
	2-7 contacts	#12 .093" (2.4)	356-12	356-1
	2-10 contacts	#16 .062" (1.6)	356-16	356-1
	2-31 contacts	#20 .040" (1)	356-20	356-1

MIL-E-QUAL Series	Connector Size	Contact Size	Insertion Bits Pins or Sockets	Handle for Bits
	All Mil-E-Qual	#12 .093" (2.4)	356-12	356-1
	Connector Sizes	#16 .062" (1.6)	356-16	356-1

Product not designed to remove contacts after insertion. Consult factory for removal tools.

Manual Contact Crimping Tools

Con-X Series	Contact Size	Handle for Tool	Description	Contact Positioners for Tools
	#12, #16, & #20	359-24	Multi Contact Tool	357-124
	#20 Only	359-21	Single Purpose Tool	357-122

MIL-E-QUAL Series	Contact Size	Handle for Tool	Description	Contact Positioners for Tools
	#12 .093" (2.4)	359-24	Hand Crimp Tool	358-112
	#16 .062" (1.6)	359-24	Hand Crimp Tool	358-112

Pneumatic Crimping Tools - Consult Factory

Contact Crimping and Assembly Procedures:

- A. Push cable through connector components, i.e. backshell, grommet, sleeve, and coupling ring.
- B. Wire preparation: Strip cable to dimensions shown. Make all cuts square and sharp being careful not to nick wires when cutting. To prevent stranded wires from fraying it is recommended that ends be tightly twisted and not solder dipped.

Conductor Strip Lengths

CON-X	MIL-E-QUAL
#20 -3/16	#16 -9/32
#16 -7/32	#12 -7/32
#12 -7/32	



Cable Stripping

- C. Contact crimping tools, use as follows:
 - Assemble contact locator to tool.
 - Check tool setting for wire gage to be crimped.
 - Drop contacts, mating end first into locator so that it rests fully on bottom. Insert stripped lead into contact barrel until it stops.
 - Close tool handles completely in one stroke. (The ratchet will not release jaws until tool has completed cycle.)
 - Inspect crimp to be sure there are no loose strands outside the contact which may short out to an adjacent contact.
- D. Contact insertion tools. Place wired contact into proper connectors cavity. Guide tip of the insertion tool so that it starts at the contact and slides down against the stop. Apply a steady force perpendicular to the contact until it snaps into position.

* Please visit the product pages on our website for the most up-to-date product information

NOTES

Компания «Океан Электроники» предлагает заключение долгосрочных отношений при поставках импортных электронных компонентов на взаимовыгодных условиях!

Наши преимущества:

- Поставка оригинальных импортных электронных компонентов напрямую с производств Америки, Европы и Азии, а так же с крупнейших складов мира;
- Широкая линейка поставок активных и пассивных импортных электронных компонентов (более 30 млн. наименований);
- Поставка сложных, дефицитных, либо снятых с производства позиций;
- Оперативные сроки поставки под заказ (от 5 рабочих дней);
- Экспресс доставка в любую точку России;
- Помощь Конструкторского Отдела и консультации квалифицированных инженеров;
- Техническая поддержка проекта, помощь в подборе аналогов, поставка прототипов;
- Поставка электронных компонентов под контролем ВП;
- Система менеджмента качества сертифицирована по Международному стандарту ISO 9001;
- При необходимости вся продукция военного и аэрокосмического назначения проходит испытания и сертификацию в лаборатории (по согласованию с заказчиком);
- Поставка специализированных компонентов военного и аэрокосмического уровня качества (Xilinx, Altera, Analog Devices, Intersil, Interpoint, Microsemi, Actel, Aeroflex, Peregrine, VPT, Syfer, Eurofarad, Texas Instruments, MS Kennedy, Miteq, Cobham, E2V, MA-COM, Hittite, Mini-Circuits, General Dynamics и др.);

Компания «Океан Электроники» является официальным дистрибьютором и эксклюзивным представителем в России одного из крупнейших производителей разъемов военного и аэрокосмического назначения «JONHON», а так же официальным дистрибьютором и эксклюзивным представителем в России производителя высокотехнологичных и надежных решений для передачи СВЧ сигналов «FORSTAR».



JONHON

«JONHON» (основан в 1970 г.)

Разъемы специального, военного и аэрокосмического назначения:

(Применяются в военной, авиационной, аэрокосмической, морской, железнодорожной, горно- и нефтедобывающей отраслях промышленности)

«FORSTAR» (основан в 1998 г.)

ВЧ соединители, коаксиальные кабели,
кабельные сборки и микроволновые компоненты:

(Применяются в телекоммуникациях гражданского и специального назначения, в средствах связи, РЛС, а так же военной, авиационной и аэрокосмической отраслях промышленности).



Телефон: 8 (812) 309-75-97 (многоканальный)

Факс: 8 (812) 320-03-32

Электронная почта: ocean@oceanchips.ru

Web: <http://oceanchips.ru/>

Адрес: 198099, г. Санкт-Петербург, ул. Калинина, д. 2, корп. 4, лит. А