

# TABLE OF CONTENTS

|  |              |
|--|--------------|
| <b>Custom Molded Cable Assemblies and Connectors</b> ..... | <b>2</b>     |
| Capabilities .....   | 3            |
| Standard Connector Products .....                          | 4            |
| Standard Connector Features .....                          | 5            |
| <b>Micro-Con-X® Series (2 and 3 Contacts)</b> .....        | <b>6</b>     |
| Dimensions .....   | 7            |
| Part Number to Order & Contact Arrangement .....           | 8            |
| Specifications .....                                       | 9            |
| <b>Mini-Con-X® Series (2 through 8 Contacts)</b> .....     | <b>10</b>    |
| Dimensions .....   | 11           |
| Part Number to Order & Contact Arrangement .....           | 12           |
| Specifications .....                                       | 13           |
| <b>Multi-Con-X® Series (2 through 9 Contacts)</b> .....    | <b>14</b>    |
| Dimensions .....   | 15           |
| Part Number to Order & Contact Arrangement .....           | 16           |
| Specifications .....                                       | 17           |
| <b>Maxi-Con-X® Series (Up to 20 Contacts)</b> .....        | <b>18</b>    |
| Dimensions .....   | 19           |
| Part Number to Order & Contact Arrangement .....           | 20           |
| Specifications .....                                       | 21           |
| <b>Mega-Con-X® Series (Up to 31 Contacts)</b> .....        | <b>22</b>    |
| Dimensions .....   | 23           |
| Part Number to Order & Contact Arrangement .....           | 24           |
| Specifications .....                                       | 25           |
| <b>Con-X Molded Cable Assembly Checklist</b> .....         | <b>26</b>    |
| <b>Con-X Current Rating Chart</b> .....                    | <b>27</b>    |
| <b>Mil-E-Qual® Series (2 through 37 Contacts)</b> .....    | <b>28</b>    |
| Dimensions .....   | 29           |
| Contact Arrangement .....                                  | 30           |
| Part Number to Order .....                                 | 31           |
| Specifications .....                                       | 32           |
| <b>Mil-E-Qual® Molded Cable Assembly Checklist</b> .....   | <b>33</b>    |
| <b>Mil-E-Qual® Current Rating Chart</b> .....              | <b>34</b>    |
| <b>Tooling</b> .....                                       | <b>34-35</b> |
| Assembly Procedures .....                                  | 35           |

\* Please visit the product pages on our website for the most up-to-date product information

# CUSTOM MOLDED CABLE ASSEMBLIES AND CONNECTORS

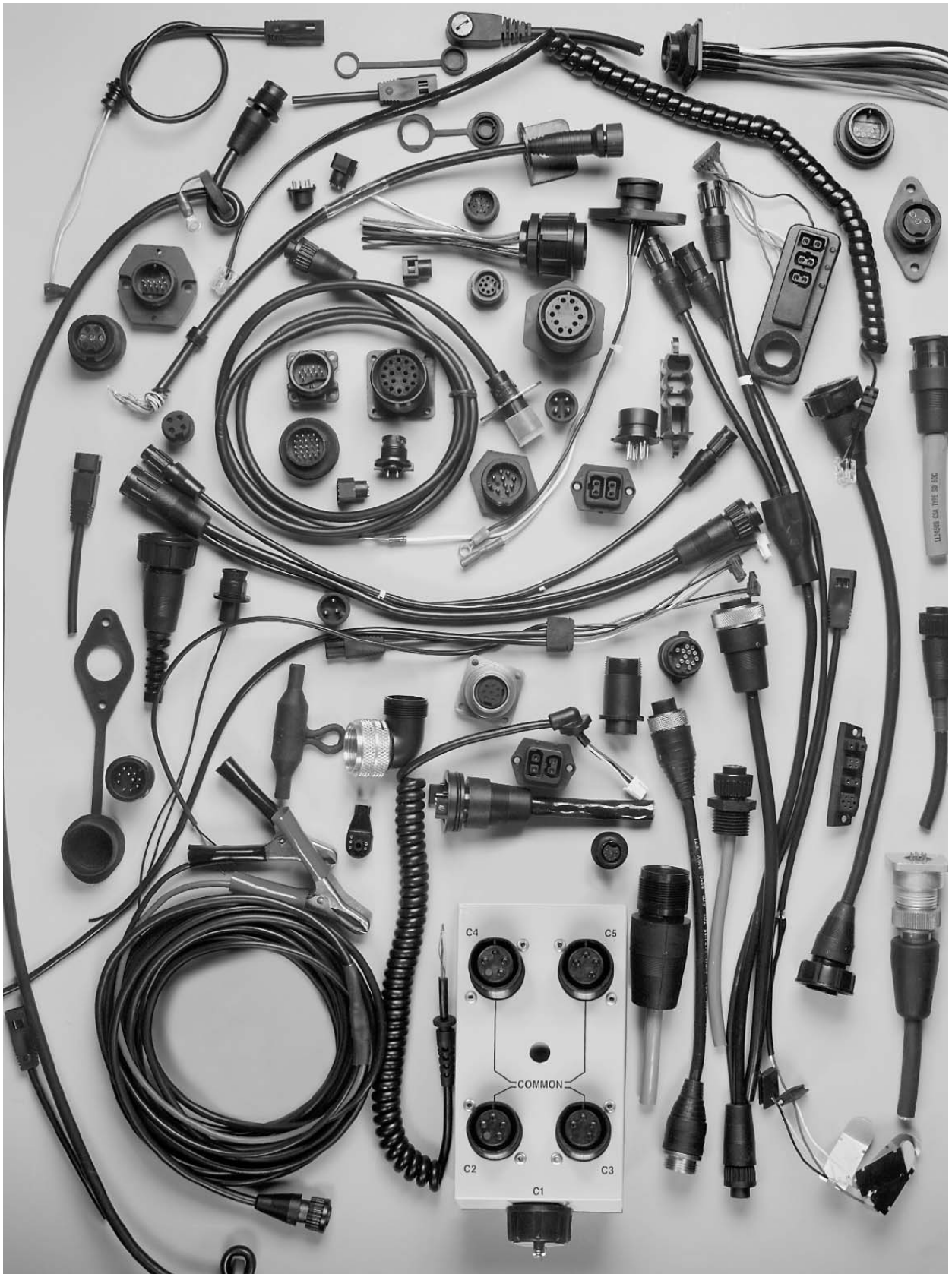

# **CUSTOM MOLDED CABLE ASSEMBLIES AND CONNECTORS**

## **Conxall History**

Conxall was founded in 1971 as a manufacturer of custom designed connectors and cable assemblies for the Marine and Industrial Markets. Since that time our custom designed products have become the standard for many other industries and Conxall's family of products has grown to include waterproof, water-tight and submersible connectors and assemblies. In recent years, Conxall has expanded its all plastic product lines to include metal shell, shielded connectors and cable assemblies designed to meet or exceed U.S., Canadian, and European shielding standards.

## **Connectors**

Conxall was an innovator in the design of all plastic cylindrical connectors. The all plastic connector provides for substantial savings in cost without sacrificing performance and quality. The all plastic connector is corrosion resistant, non-conductive and withstands substantial abuse, hostile environments, and heavy impacts that would otherwise cause metal connectors to corrode, deform or become electrically conductive and thus become unusable or unsafe. Our standard lines of all plastic connectors covers a wide range of shell styles and insert configurations including the all plastic Mil-C-5015 Connector series which is intermateable with, and provides a high quality replacement for, expensive, all metal, military standard connectors.

## **Assembly Capabilities**

Conxall has specialized in custom molded cable assemblies and connectors for a wide variety of applications including: Industrial, Automotive, Marine, Transportation, Medical, Communication, Sensor and Factory Automation. The Conxall exclusive molded cable assembly process affords the additional advantages of reduced cost and weather tight reliability plus the added benefits of permanent and service free termination without the risk of cable pull out. Our SENSOR-LINK, Mini, Micro, and Nano style connectors and cable assemblies are NEMA rated, available in shielded and standard styles and are UL and CSA certified for many applications. For additional information on SENSOR-LINK products please contact your Conxall Representative.

## **Custom Designs**

Conxall remains dedicated to providing High Quality, Low Cost solutions to your interconnect problems. Our Service Teams will work with you from the initial design to the finished product to insure your complete satisfaction. We offer a full line of standard and weather tight connectors. But perhaps your needs are unique. If so, Conxall has the capability to create original designs to meet your needs. Our team of engineers and research and development personnel will work side by side with your staff to custom design a solution for your needs.

Contact Conxall for your Interconnection Solutions. Our quick response and personalized service set Conxall apart from any other company in the industry.

# STANDARD CONNECTOR PRODUCTS

## Low-cost Standard and Weathertight Connectors for Industrial and Marine Applications.

A completely indoor/outdoor connector system that offers performance and reliability features of MIL-Spec connectors at the cost of a commercial type product.

**Economical...**The all molded nylon construction provides for substantial savings in cost that helps hold the line on cost objectives without sacrificing performance.

### Standard Assemblies

Ideally satisfies power connections for test instruments, calibration or measuring equipment, communications systems, data processing, entertainment devices and a wide range of non-environmental applications where economy and maintenance-free reliability are essential. Especially suited to laboratory instruments, medical analysis devices, automotive test equipment, computer peripherals, recording instruments, etc....

**Style...**Designed for demanding service although attractive and modern in appearance to complement the most sophisticated equipment.

**Lightweight/Strong...**50% weight savings over similar metal construction yet has tough, high-impact strength to withstand hard abuse both indoors and outdoors.

### Weathertight Assemblies

Optional panel connector gaskets and interfacial "O" ring seals maintain a weathertight connection for outdoor use. The non-corrosive, high impact, all molded construction is perfect for recreational, agricultural or on/off the road vehicle connections. Hazards of electrical shock are minimized in addition to resistance to hostile outdoor environment. Frequently specified for depth sounders, metal detectors, marine/aircraft electronics, boat trailers, electronic farm implements, food processing equipment, etc.

## Molded Cable Assemblies (See pages 3 & 26)

---

## Complete Facilities to Assemble and/or Mold All Connector Styles to Many Cable Constructions

**Permanently Molded...**Cable and connectors are molded together in a choice of attractive boot shapes to add functional improvements to your product.

**Accident Proof...**Molded encapsulation between cable and connector prevents pull-out or breakage of internal wires for maintenance free operation.

**Weathertight...**This construction prevents ingress of moisture into contact areas.

**Saves Time and Money...**Avoids setting up new production line and training personnel plus cost of maintaining inventories.

## STANDARD CONNECTOR FEATURES

**Panel Connector** mounts from behind in round or “D” shaped hole and are securely fastened with hex nut on the front of the panel. Standard assembly include weathertight gasket.

**Premium Quality** The standard screw-machine socket contact has premium design features at low cost. The closed entry prevents probe damage or accidental loss of spring retention due to misaligned or bent pins.

**Reverse Contact Options** are available providing pin or socket contacts in all styles.

**Locking Type** coupling ring prevents accidental disconnect. Quick 90 degree connect/disconnect rotation or threaded.

**Cable Splices** and/or extension cables can be easily made using the cable to cable connectors.

**Unassembled Cable Connectors** without mold-on cables are available. This option provides for field installation or replacement service on existing cable assemblies.

---

**Dimensions and Specifications** are for reference only and may change without notice where it does not affect form, fit or function.

**Electrical Rating Tables** are for reference only and are based on continuous current carrying capacity of the connector with all contacts carrying current.

## Packaging and Warranty

---

### Packaging

Connectors: Standard Con-X series components are packaged unassembled and individually bulk packed. Kitted packaging, one complete connector per bag, available upon request for an additional cost. Mil-E-Qual components are assembled and individually kitted in plastic bags.

Cable Assemblies: Assemblies less than 3 ft., including connector head, are bundled and boxed. Assemblies over 3 ft., including connector head, are coiled, secured with cable tie and boxed.

### Warranty

CONXALL Corp. manufactures the finest quality product available to the marketplace. However, these products are intended to be used in accordance with the specifications described in this catalog. Any use or application that deviates from the stated operating specifications is not recommended and **may be unsafe**. A limited warranty applies to all CONXALL Corp. products. Except for obligations specifically assumed by CONXALL Corp. under warranty, CONXALL Corp. will not be liable for any loss, damage, cost of repairs, incidental or consequential damages of any kind whether or not based upon expressed or implied warranty, contract, negligence, or strict liability arising in connection with the design, manufacture, sale, use or repair of the products.

\* Please visit the product pages on our website for the most up-to-date product information

# MICRO-CON-X® FIELD INSTALLABLE CONNECTORS



**Cable Pin**  
1628X-XPB-XXX  
**Matching Mates:**

- **Cable-Cable**  
1828X-XSB-XXX
- **Panel**  
172XX-XSB-XXX



**Panel Mount**  
1728X-XXB-XXX  
**Matching Mates:**

- **Cable Pin**  
1628X-XPB-XXX
- **Cable Socket**  
1628X-XSB-XXX



**P/C Tail Panel Mount**  
172XX-XXB-XXX  
**Matching Mates:**

- **Cable Pin**  
1628X-XPB-XXX
- **Cable Socket**  
1628X-XSB-XXX



**Cable Socket**  
1628X-XSB-XXX  
**Matching Mates:**

- **Cable-Cable**  
1828X-XPB-XXX
- **Panel**  
172XX-XPB-XXX



**Cable to Cable**  
1828X-XXB-XXX  
**Matching Mates:**

- **Cable Pin**  
1628X-XPB-XXX
- **Cable Socket**  
1628X-XSB-XXX



**Dust Cap**  
16295

## Molded Cable Assemblies (See pages 3 & 26)



**Cable End**



**Cable to Cable**



**Right Angle**

\* Please visit the product pages on our website for the most up-to-date product information

# MICRO-CON-X® FIELD INSTALLABLE CONNECTORS

## Dimensions (Dimensions in brackets are in millimeters)



**CABLE END CONNECTOR - WITH SNAP LOCK BACKSHELL (NON-REMOVABLE)**



**PANEL MOUNT CONNECTOR - SHOWN WITH HEX NUT AND GASKET**



**CABLE TO CABLE CONNECTOR - WITH SNAP LOCK BACKSHELL (NON-REMOVEABLE)**

## Molded Cable Assemblies (See pages 3 & 26)



**CABLE END ASSEMBLY**  
STRAIGHT BOOT  
0.280 [7.1] MAX. CABLE O.D.



**CABLE TO CABLE ASSEMBLY**  
STRAIGHT BOOT  
0.280 [7.1] MAX. CABLE O.D.



**CABLE END ASSEMBLY**  
90° BOOT  
0.280 [7.1] MAX. CABLE O.D.

\* Please visit the product pages on our website for the most up-to-date product information

# MICRO-CON-X<sup>®</sup> FIELD INSTALLABLE CONNECTORS

## Part Number to Order



\*Available in #20 size contact only.

**Consult factory for optional threaded coupling.**

**Consult factory for your custom design cable assemblies and connectors. (See pages 3 & 26)**

## Contact Arrangements



Contact arrangements shown are wiring view of cable end pins/sockets.  
 Key/keyway shown for orientation only.

For higher density patterns, consult factory.



# MICRO-CON-X<sup>®</sup> FIELD INSTALLABLE CONNECTORS

## Specifications

### Typical Specifications

|                               |   |
|-------------------------------|---|
| Manufacturers Identifications | Micro-Con-X <sup>®</sup>  |
| Description                   | Field Installable Connector & Custom Cable Assemblies                   |
| Rating                        | 3.0 thru 7.5A, 600V   |
| Conductor Size                | 20 thru 24 AWG  |
| Configuration                 | 2 & 3 #20 Contacts  |
| Certification                 | UL Recognized File #E150822 - 250V<br>CSA Certified File #181200 - 600V |

### Material Specifications

#### Cable Pin/Socket

|                                     |                             |
|-------------------------------------|-----------------------------|
| Backshell (Non-Removable Snap Lock) | Nylon, UL Recognized, Black |
| Grommet                             | Santoprene Rubber, Black    |
| Coupling Ring                       | Nylon, UL Recognized, Black |
| Contacts                            | Brass, Gold over Nickel     |
| Connector Body                      | Nylon, UL Recognized, Black |
| O-Ring                              | Neoprene Rubber, Black      |

#### Cable to Cable

|                                     |                             |
|-------------------------------------|-----------------------------|
| Backshell (Non-Removable Snap Lock) | Nylon, UL Recognized, Black |
| Grommet                             | Santoprene Rubber, Black    |
| Contacts                            | Brass, Gold over Nickel     |
| Connector Body                      | Nylon, UL Recognized, Black |

#### Panel Mount

|            |                             |
|------------|-----------------------------|
| Contacts   | Brass, Gold over Nickel     |
| Panel Body | Nylon, UL Recognized, Black |
| Gasket     | Neoprene Rubber, Black      |
| Hex Nut    | Nylon, UL Recognized, Black |

#### Optional

|          |   |
|----------|---|
| Dust Cap | Santoprene Rubber, Black (Part No. 16295) |
|----------|---|

Gasket, O-Ring, & Grommet materials are suitable for -40°C to +90°C (-40°F to +194°F). Consult factory for higher temperature requirements.

### Mechanical Specifications

|                |  |
|----------------|--|
| Durability     | Minimum 300 mate/unmate cycles without mechanical or electrical failure                        |
| Vibration      | Coupling rings have overriding locking feature to prevent loosening or separation of connector |
| Hex Nut Torque | All series hex nut to withstand 10-12 inch/lb tightening torque.                               |

### Electrical Specifications

|         |   |
|---------|---|
| Voltage | 600 V   |
| Current | See Electrical Current Rating Chart (Page 27) |

### Environmental Specifications

|                    |   |
|--------------------|---|
| Temperature Rating | -40°C to +115°C (-40°F to +239°F)         |
| Corrosion          | 300 Hr salt spray contacts                |
| Weathertight       | Consult factory with specific application |

### Molded Cable Assemblies

|            |   |
|------------|---|
| Watertight | (See Pages 3 & 26)<br>NEMA 6P, 13: IEC IP67 |
|------------|---|

\* Please visit the product pages on our website for the most up-to-date product information

# MINI-CON-X® FIELD INSTALLABLE CONNECTORS



**Cable Pin**

6X8X-XPG-XXX

**Matching Mates:**

- **Cable-Cable**  
8X8X-XSG-XXX
- **Panel**  
7XXX-XSG-XXX



**Panel Mount**

7X8X-XXG-XXX

**Matching Mates:**

- **Cable Pin**  
6X8X-XPG-XXX
- **Cable Socket**  
6X8X-XSG-XXX



**P/C Tail Panel Mount**

7XXX-XXG-XXX

**Matching Mates:**

- **Cable Pin**  
6X8X-XPG-XXX
- **Cable Socket**  
6X8X-XSG-XXX



**Cable Socket**

6X8X-XSG-XXX

**Matching Mates:**

- **Cable-Cable**  
8X8X-XPG-XXX
- **Panel**  
7XXX-XPG-XXX



**Cable to Cable**

8X8X-XXG-XXX

**Matching Mates:**

- **Cable Pin**  
6X8X-XPG-XXX
- **Cable Socket**  
6X8X-XSG-XXX



**Dust Cap**

6295



**Winged Coupling Ring**

W/6482

## Molded Cable Assemblies (See pages 3 & 26)



**Cable End**



**Cable to Cable**



**Right Angle**

\* Please visit the product pages on our website for the most up-to-date product information

# MINI-CON-X<sup>®</sup> FIELD INSTALLABLE CONNECTORS

## Dimensions (Dimensions in brackets are in millimeters)



**CABLE END CONNECTOR**  
STYLE 5 LONG  
TWIST LOCK BACKSHELL

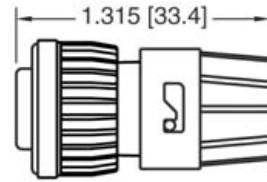

**CABLE END CONNECTOR**  
STYLE 3 AND 3DC SHORT  
TWIST LOCK BACKSHELL



5/8 [15.9]-27 UNEF THREAD  
1/32 TO 3/16 PANEL  
[0.8 TO 4.8]

**PANEL MOUNT CONNECTOR**  
SHOWN WITH HEX NUT AND GASKET

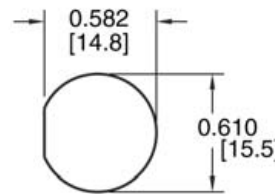

RECOMMENDED  
PANEL CUT-OUT  
±.003 [±0.1]

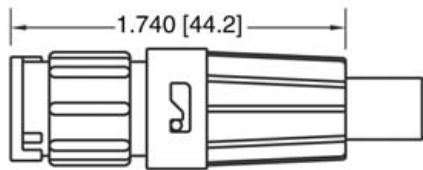

**CABLE TO CABLE CONNECTOR**  
STYLE 5 LONG  
TWIST LOCK BACKSHELL

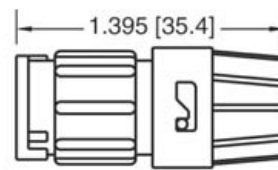

**CABLE TO CABLE CONNECTOR**  
STYLE 3 AND 3DC SHORT  
TWIST LOCK BACKSHELL

## Molded Cable Assemblies (See pages 3 & 26)



**CABLE END ASSEMBLY**  
STRAIGHT BOOT  
0.375 [9.5] MAX. CABLE O.D.



**CABLE TO CABLE ASSEMBLY**  
STRAIGHT BOOT  
0.375 [9.5] MAX. CABLE O.D.



**CABLE END ASSEMBLY**  
90° BOOT  
0.310 [7.9] MAX. CABLE O.D.

\* Please visit the product pages on our website for the most up-to-date product information

# MINI-CON-X® FIELD INSTALLABLE CONNECTORS

## Part Number to Order

**X X XX-XXG-XXX**

**Connector Type:** \_\_\_\_\_  
 6 - Cable End  
 7 - Panel Mount  
 8 - Cable to Cable

**Contact Size:** \_\_\_\_\_  
 2 - #20 (2-8 Contacts)  
 3 - #16 (2-5 Contacts)

**Contact Style:** \_\_\_\_\_  
 80 - Crimp (Supplied loose)  
 81 - P/C Tail .187" (4.7) (Supplied assembled)  
 82 - Solder Cup (Supplied assembled)  
 91 - P/C Tail .280" (7.1) (Supplied assembled)\*  
 92 - P/C Tail .335" (8.5) (Supplied assembled)\*

**Number of Contacts:** \_\_\_\_\_  
 2, 3, 4, 5, 6, 7 & 8

**Type of Contact:** \_\_\_\_\_  
 P - Pin  
 S - Socket

**Contact Plating:** \_\_\_\_\_  
 G - Gold over Nickel (Standard)

**Grommet Code – Cable O.D. Range:**  
**11** - .09 - .14 (2.3 - 3.5)  
**15** - .15 - .17 (3.8 - 4.3)  
**18** - .18 - .20 (4.6 - 5.1)  
**21** - .21 - .23 (5.3 - 5.8)

**Back Shell Style 3**  
**13** - .13 - .15 (3.3 - 3.8)  
**16** - .16 - .18 (4.1 - 4.6)  
**19** - .19 - .21 (4.8 - 5.3)  
**22** - .22 - .25 (5.6 - 6.3)

**Back Shell Style 5**

**Back Shell Style:**  
**3** Weathertight grommet grip/seal & (1) interfacial "O" ring.  
**3DC** - Daisy chain grommet with 3 I.D.s. (.125, .188 & .250)  
**5** Long back shell with extended grommet & cable grip. Use with crimp or solder.

**300** - Panel mount with hex nut & gasket.  
**3ES** - 300 with Epoxy

\*Available in #20 size contact only.

Consult factory for optional threaded coupling.

Consult factory for your custom design cable assemblies and connectors. (See pages 3 & 26)

## Contact Arrangements



Contact arrangements shown are wiring view of cable end pins/sockets.

Key/keyway shown for orientation only.

\*Available in connector types: cable end socket, panel mount pin, and cable to cable pin styles only.

# MINI-CON-X® FIELD INSTALLABLE CONNECTORS

## Specifications

### Typical Specifications

|                               |   |
|-------------------------------|---|
| Manufacturers Identifications | Mini-Con-X®   |
| Description                   | Field Installable Connector & Custom Cable Assemblies                   |
| Rating                        | 4.8 thru 13.0A, 600V  |
| Conductor Size                | #16 contacts, 16 thru 18 AWG<br>#20 contacts, 20 thru 24 AWG            |
| Configuration                 | 2 thru 5 #16 Contacts or 2 thru 8 #20 Contacts                          |
| Certification                 | UL Recognized File #E150822 - 250V<br>CSA Certified File #181200 - 600V |

### Material Specifications

#### Cable Pin/Socket

|                                  |                             |
|----------------------------------|-----------------------------|
| Backshell (Removable Twist Lock) | Nylon, UL Recognized, Black |
| Grommet                          | Santoprene Rubber, Black    |
| Coupling Ring                    | Nylon, UL Recognized, Black |
| Contacts                         | Brass, Gold over Nickel     |
| Connector Body                   | Nylon, UL Recognized, Black |
| O-Ring                           | Neoprene Rubber, Black      |

#### Optional

|                                       |  |
|---------------------------------------|--|
| Long Backshell (Removable Twist Lock) | Nylon, UL Recognized, Black (Style #5) |
| Winged Coupling Ring                  | Nylon, UL Recognized, Black (W/6482)   |

#### Cable to Cable

|                                  |                             |
|----------------------------------|-----------------------------|
| Backshell (Removable Twist Lock) | Nylon, UL Recognized, Black |
| Grommet                          | Santoprene Rubber, Black    |
| Contacts                         | Brass, Gold over Nickel     |
| Connector Body                   | Nylon, UL Recognized, Black |

#### Panel Mount

|            |                             |
|------------|-----------------------------|
| Contacts   | Brass, Gold over Nickel     |
| Panel Body | Nylon, UL Recognized, Black |
| Gasket     | Neoprene Rubber, Black      |
| Hex Nut    | Nylon, UL Recognized, Black |

#### Optional

|          |  |
|----------|--|
| Dust Cap | Santoprene Rubber, Black (Part No. 6295) |
|----------|--|

Gasket, O-Ring, & Grommet materials are suitable for -40°C to +90°C (-40°F to +194°F). Consult factory for higher temperature requirements.

### Mechanical Specifications

|                |  |
|----------------|--|
| Durability     | Minimum 300 mate/unmate cycles without mechanical or electrical failure                        |
| Vibration      | Coupling rings have overriding locking feature to prevent loosening or separation of connector |
| Hex Nut Torque | All series hex nut to withstand 10-12 inch/lb tightening torque.                               |

### Electrical Specifications

|         |   |
|---------|---|
| Voltage | 600 V   |
| Current | See Electrical Current Rating Chart (Page 27) |

### Environmental Specifications

|                    |   |
|--------------------|---|
| Temperature Rating | -40°C to +115°C (-40°F to +239°F)         |
| Corrosion          | 300 Hr salt spray contacts                |
| Weathertight       | Consult factory with specific application |

### Molded Cable Assemblies

|            |   |
|------------|---|
| Watertight | (See Pages 3 & 26)<br>NEMA 6P, 13: IEC IP67 |
|------------|---|

\* Please visit the product pages on our website for the most up-to-date product information

# MULTI-CON-X® FIELD INSTALLABLE CONNECTORS



**Cable Pin**  
3X8X-XPB-XXX  
**Matching Mates:**

- Cable-Cable  
5X8X-XSB-XXX
- Panel  
4XXX-XSB-XXX



**Panel Mount**  
4X8X-XXB-XXX  
**Matching Mates:**

- Cable Pin  
3X8X-XPB-XXX
- Cable Socket  
3X8X-XSB-XXX



**P/C Tail Panel Mount**  
4XXX-XXB-XXX  
**Matching Mates:**

- Cable Pin  
3X8X-XPB-XXX
- Cable Socket  
3X8X-XSB-XXX



**Cable Socket**  
3X8X-XSB-XXX  
**Matching Mates:**

- Cable-Cable  
5X8X-XPB-XXX
- Panel  
4XXX-XPB-XXX



**Cable to Cable**  
5X8X-XXB-XXX  
**Matching Mates:**

- Cable Pin  
3X8X-XPB-XXX
- Cable Socket  
3X8X-XSB-XXX



**Mechanical Back Shell**  
(Style #5)



**Square Flange Adapter**  
4296

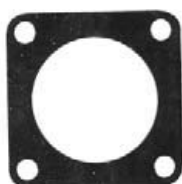

**Square Flange Gasket**  
4297



**Dust Cap**  
4295



**Winged Coupling Ring**  
W/4482

## Molded Cable Assemblies (See pages 3 & 26)



**Cable End**



**Cable to Cable**



**Right Angle**

\* Please visit the product pages on our website for the most up-to-date product information

# MULTI-CON-X® FIELD INSTALLABLE CONNECTORS

## Dimensions (Dimensions in brackets are in millimeters)



## Molded Cable Assemblies (See pages 3 & 26)



# MULTI-CON-X® FIELD INSTALLABLE CONNECTORS

## Part Number to Order

|  |  |  |
|--|--|--|
| <p style="text-align: center; font-weight: bold; font-size: 1.2em;">X X XX-X XG-XXX</p> <p><b>Connector Type:</b> _____<br/>         3 - Cable End<br/>         4 - Panel Mount<br/>         5 - Cable to Cable</p> <p><b>Contact Size:</b> _____<br/>         1 - #12 (2-4 Contacts)<br/>         2 - #20 (4-9 Contacts)<br/>         3 - #16 (4-6 Contacts)</p> <p><b>Contact Style:</b> _____<br/>         80 - Crimp (Supplied loose)<br/>         81 - P/C Tail .187" (4.7) (Supplied assembled)<br/>         82 - Solder Cup (Supplied assembled)<br/>         91 - P/C Tail .280" (7.1) (Supplied assembled)*<br/>         92 - P/C Tail .335" (8.5) (Supplied assembled)*</p> <p><b>Number of Contacts:</b> _____<br/>         2, 3, 4, 5, 6, 7, 8 &amp; 9</p> <p><b>Type of Contact:</b> _____<br/>         P - Pin<br/>         S - Socket</p> <p><b>Contact Plating:</b> _____<br/>         G - Gold over Nickel (Standard)</p> | <p><b>Back Shell Style</b><br/> <b>3 or 5</b></p> <p><b>Back Shell Style:</b><br/> <b>3</b> - Weathertight grommet grip/seal &amp; (1) interfacial "O"ring.<br/> <b>3DC</b> - Daisy chain grommet with 3 I.D.s (.125, .188 &amp; .250)<br/> <b>5</b> - Mechanical screw-down cable clamp with grommet seal.</p> <p><b>300</b> - Panel mount with hex nut &amp; gasket.<br/> <b>3ES</b> - 300 with Epoxy (Panel Mount Only)</p> | <p><b>Grommet Code – Cable O.D. Range:</b><br/> <b>15</b> - .15 - .17 (3.8-4.3)<br/> <b>18</b> - .18 - .20 (4.6-5.1)<br/> <b>21</b> - .21 - .23 (5.3-5.8)<br/> <b>24</b> - .24 - .27 (6.1-6.8)<br/> <b>28</b> - .28 - .29 (7.1-7.4)<br/> <b>30</b> - .30 - .32 (7.6-8.1)</p> |
|--|--|--|

**EMI/RFI shielded assemblies available - consult factory.**  
 \*Available in #20 size contact only.  
**Consult factory for optional threaded coupling.**  
**Consult factory for your custom design cable assemblies and connectors. (See pages 3 & 26)**

## Contact Arrangements



Contact arrangements shown are wiring view of cable end pins/sockets.

Key/keyway shown for orientation only.

\*Available in connector types: cable end socket, panel mount pin, and cable to cable pin styles only.



# MULTI-CON-X® FIELD INSTALLABLE CONNECTORS

## Specifications

### Typical Specifications

|                               |  |
|-------------------------------|--|
| Manufacturers Identifications | Multi-Con-X®   |
| Description                   | Field Installable Connector & Custom Cable Assemblies  |
| Rating                        | 1.95 thru 23.0A, 600V  |
| Conductor Size                | #12 Contacts, 12 thru 14 AWG<br>#16 Contacts, 16 thru 18 AWG<br>#20 Contacts, 20 thru 24 AWG |
| Configuration                 | 2 thru 4 #12 Contacts<br>4 thru 6 #16 Contacts<br>4 thru 9 #20 Contacts                      |
| Certification                 | UL Recognized File #E150822 - 250V<br>CSA Certified File #181200 - 600V                      |

### Material Specifications

#### Cable Pin/Socket

|                      |  |
|----------------------|--|
| Backshell (Threaded) | Nylon, UL Recognized, Black (Style #3) |
| Grommet              | Santoprene Rubber, Black               |
| Coupling Ring        | Nylon, UL Recognized, Black            |
| Contacts             | Brass, Gold over Nickel                |
| Connector Body       | Nylon, UL Recognized, Black            |
| O-Ring               | Neoprene Rubber, Black                 |
| Sleeve               | Nylon, UL Recognized, Black            |

#### Cable to Cable

|                      |  |
|----------------------|--|
| Backshell (Threaded) | Nylon, UL Recognized, Black (Style #3) |
| Grommet              | Santoprene, Rubber, Black              |
| Contacts             | Brass, Gold over Nickel                |
| Connector Body       | Nylon, UL Recognized, Black            |

#### Optional

|                                 |   |
|---------------------------------|---|
| Long Backshell (Threaded)       | Nylon, UL Recognized, Black (Style #3 with solder contacts) |
| Winged Coupling Ring            | Nylon, UL Recognized, Black (W/4482)                        |
| Mechanical Backshell (Threaded) | Nylon, UL Recognized, Black (Style #5)                      |
| - Strap                         | Nylon, UL Recognized, Black                                 |
| - Screws                        | Stainless Steel   |

#### Panel Mount

|            |                             |
|------------|-----------------------------|
| Contacts   | Brass, Gold over Nickel     |
| Panel Body | Nylon, UL Recognized, Black |
| Gasket     | Neoprene Rubber, Black      |
| Hex Nut    | Nylon, UL Recognized, Black |

#### Optional

|                              |   |
|------------------------------|---|
| Dust Cap                     | Santoprene Rubber, Black (Part No. 4295)    |
| Square Flange Adapter        | Nylon, UL Recognized, Black (Part No. 4296) |
| Square Flange Adapter Gasket | Neoprene Rubber, Black (Part No. 4297)      |

Gasket, O-Ring, & Grommet materials are suitable for -40°C to +90°C (-40°F to +194°F). Consult factory for higher temperature requirements.

### Mechanical Specifications

|                |  |
|----------------|--|
| Durability     | Minimum 300 mate/unmate cycles without mechanical or electrical failure                        |
| Vibration      | Coupling rings have overriding locking feature to prevent loosening or separation of connector |
| Hex Nut Torque | All series hex nut to withstand 10-12 inch/lb tightening torque.                               |

### Electrical Specifications

|         |   |
|---------|---|
| Voltage | 600 V   |
| Current | See Electrical Current Rating Chart (Page 27) |

### Environmental Specifications

|                         |  |
|-------------------------|--|
| Temperature Rating      | -40°C to +115°C (-40°F to +239°F)                            |
| Corrosion               | 300 Hr salt spray contacts                                   |
| Weathertight            | Consult factory with specific application (See Pages 3 & 26) |
| Molded Cable Assemblies | NEMA 6P, 13; IEC IP67  |
| Watertight              |  |

# MAXI-CON-X<sup>®</sup> FIELD INSTALLABLE CONNECTORS



**Cable Pin**  
13X8X-XXPG-XXX  
**Matching Mates:**  
• **Cable-Cable**  
15X8X-XXSG-XXX  
• **Panel**  
14XXX-XXSG-XXX



**Panel Mount**  
14X8X-XXXG-XXX  
**Matching Mates:**  
• **Cable Pin**  
13X8X-XXPG-XXX  
• **Cable Socket**  
13X8X-XXSG-XXX



**P/C Tail Panel Mount**  
14XXX-XXXG-XXX  
**Matching Mates:**  
• **Cable Pin**  
13X8X-XXPG-XXX  
• **Cable Socket**  
13X8X-XXSG-XXX



**Cable Socket**  
13X8X-XXSG-XXX  
**Matching Mates:**  
• **Cable-Cable**  
15X8X-XXPG-XXX  
• **Panel**  
14XXX-XXPG-XXX



**Cable to Cable**  
15X8X-XXXG-XXX  
**Matching Mates:**  
• **Cable Pin**  
13X8X-XXPG-XXX  
• **Cable Socket**  
13X8X-XXSG-XXX



**Winged Coupling Ring**  
W/14482



**Dust Cap**  
14295

## Molded Cable Assemblies (See pages 3 & 26)



**Cable End**



**Cable to Cable**



**Right Angle**

\* Please visit the product pages on our website for the most up-to-date product information

# MAXI-CON-X<sup>®</sup> FIELD INSTALLABLE CONNECTORS

## Dimensions (Dimensions in brackets are in millimeters)

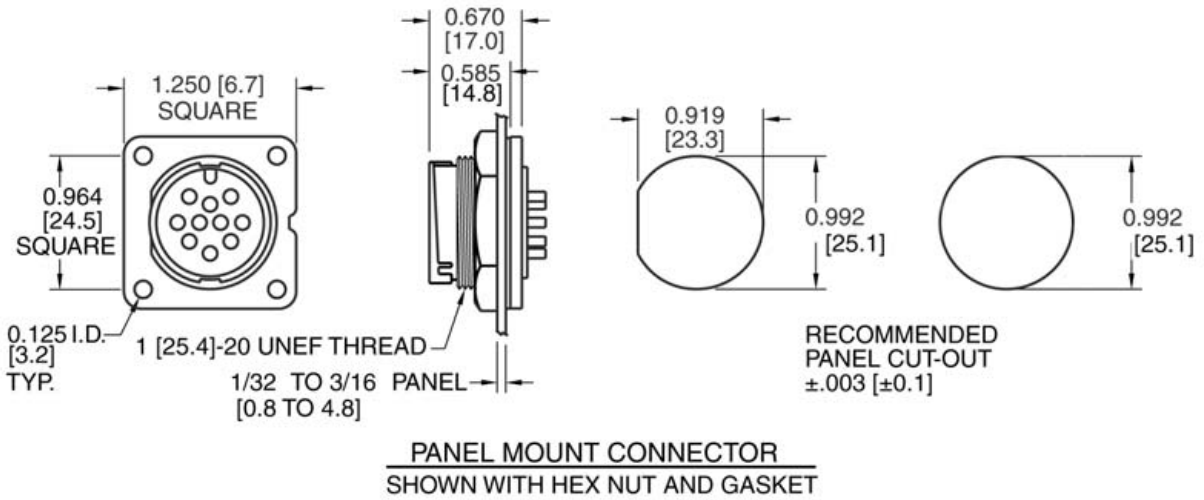

## Molded Cable Assemblies (See pages 3 & 26)



# MAXI-CON-X® FIELD INSTALLABLE CONNECTORS

## Part Number to Order

**XX X XX-XX XG-3XX**

**Connector Type:** \_\_\_\_\_

- 13 - Cable End
- 14 - Panel Mount
- 15 - Cable to Cable

**Contact Size:** \_\_\_\_\_

- 1 - #12 (7 Contacts)
- 2 - #20 (18 & 20 Contacts)
- 3 - #16 (10 Contacts)

**Contact Style:** \_\_\_\_\_

- 80 - Crimp (Supplied loose)
- 81 - P/C Tail .187" (4.7) (Supplied assembled)
- 82 - Solder Cup (Supplied assembled)
- 91 - P/C Tail .280" (7.1) (Supplied assembled)\*
- 92 - P/C Tail .335" (8.5) (Supplied assembled)\*

**Number of Contacts:** \_\_\_\_\_

- 7, 10, 18 & 20

**Type of Contact:** \_\_\_\_\_

- P - Pin
- S - Socket

**Contact Plating:** \_\_\_\_\_

- G - Gold over Nickel (Standard)

**EMI/RFI shielded assemblies available - consult factory.**

\*Available in #20 size contact only.

**Consult factory for optional threaded coupling.**

**Consult factory for your custom design cable assemblies and connectors. (See pages 3 & 26)**

**Grommet Code – Cable O.D. Range:**  
**Back Shell Style 3**  
 21 - .21 - .25 (5.3-6.3)  
 26 - .26 - .30 (6.6-7.6)  
 31 - .31 - .38 (7.8-9.6)

**Back Shell Style:**  
 3 Mechanical screw-down cable clamp with grommet seal and (1) interfacial "O" ring for cable end.

**300** - Panel mount with hex nut & gasket.  
**3ES** - 300 with Epoxy

## Contact Arrangements



Contact arrangements shown are wiring view of cable end pins/sockets.

Key/keyway shown for orientation only.

\*Available in connector types: cable end socket, panel mount pin styles only.

# MAXI-CON-X<sup>®</sup> FIELD INSTALLABLE CONNECTORS

## Specifications

### Typical Specifications

|                               |  |
|-------------------------------|--|
| Manufacturers Identifications | Maxi-Con-X <sup>®</sup>  |
| Description                   | Field Installable Connector & Custom Cable Assemblies  |
| Rating                        | 1.35 thru 23.0A, 600V  |
| Conductor Size                | #12 Contacts, 12 thru 14 AWG<br>#16 Contacts, 16 thru 18 AWG<br>#20 Contacts, 20 thru 24 AWG |
| Configuration                 | 7 - #12 Contacts<br>10 - #16 Contacts<br>18 - #20 Contacts<br>20 - #20 Contacts              |
| Certification                 | UL Recognized File #E150822 - 250V<br>CSA Certified File #181200 - 600V                      |

### Material Specifications

#### Cable Pin/Socket

|                                 |                             |
|---------------------------------|-----------------------------|
| Mechanical Backshell (Threaded) | Nylon, UL Recognized, Black |
| Strap                           | Nylon, UL Recognized, Black |
| Screws                          | Stainless Steel             |
| Grommet                         | Santoprene Rubber, Black    |
| Coupling Ring                   | Nylon, UL Recognized, Black |
| Contacts                        | Brass, Gold over Nickel     |
| Connector Body                  | Nylon, UL Recognized, Black |
| O-Ring                          | Neoprene Rubber, Black      |

#### Optional

|                      |                                       |
|----------------------|---------------------------------------|
| Winged Coupling Ring | Nylon, UL Recognized, Black (W/14482) |
|----------------------|---------------------------------------|

#### Cable to Cable

|                                 |                             |
|---------------------------------|-----------------------------|
| Mechanical Backshell (Threaded) | Nylon, UL Recognized, Black |
| Grommet                         | Santoprene Rubber, Black    |
| Strap                           | Nylon, UL Recognized, Black |
| Screws                          | Stainless Steel             |
| Contacts                        | Brass, Gold over Nickel     |
| Connector Body                  | Nylon, UL Recognized, Black |

#### Panel Mount

|            |                             |
|------------|-----------------------------|
| Contacts   | Brass, Gold over Nickel     |
| Panel Body | Nylon, UL Recognized, Black |
| Gasket     | Neoprene Rubber, Black      |
| Hex Nut    | Nylon, UL Recognized, Black |

#### Optional

|          |   |
|----------|---|
| Dust Cap | Santoprene Rubber, Black (Part No. 14295) |
|----------|---|

Gasket, O-Ring, & Grommet materials are suitable for -40°C to +90°C (-40°F to +194°F). Consult factory for higher temperature requirements.

### Mechanical Specifications

|                |  |
|----------------|--|
| Durability     | Minimum 300 mate/unmate cycles without mechanical or electrical failure                        |
| Vibration      | Coupling rings have overriding locking feature to prevent loosening or separation of connector |
| Hex Nut Torque | All series hex nut to withstand 10-12 inch/lb tightening torque                                |

### Electrical Specifications

|         |   |
|---------|---|
| Voltage | 600 V   |
| Current | See Electrical Current Rating Chart (Page 27) |

### Environmental Specifications

|                    |   |
|--------------------|---|
| Temperature Rating | -40°C to +115°C (-40°F to +239°F)         |
| Corrosion          | 300 Hr salt spray contacts                |
| Weathertight       | Consult factory with specific application |

### Molded Cable Assemblies

|            |   |
|------------|---|
| Watertight | (See Pages 3 & 26)<br>NEMA 6P, 13; IEC IP67 |
|------------|---|

\* Please visit the product pages on our website for the most up-to-date product information

# MEGA-CON-X® FIELD INSTALLABLE CONNECTORS



**Cable Pin**  
23X8X-XXPG-XXX  
**Matching Mate:**  
• **Panel**  
24XXX-XXSG-XXX



**Panel Mount**  
24XXX-XXXG-XXX  
**Matching Mates:**  
• **Cable Pin**  
23X8X-XXPG-XXX  
• **Cable Socket**  
23X8X-XXSG-XXX



**Cable Socket**  
23X8X-XXSG-XXX  
**Matching Mate:**  
• **Panel**  
24XXX-XXPG-XXX



**P/C Tail Panel Mount**  
24XXX-XXXG-XXX  
**Matching Mates:**  
• **Cable Pin**  
23X8X-XXPG-XXX  
• **Cable Socket**  
23X8X-XXSG-XXX



**Dustcap**  
24295

## Molded Cable Assemblies (See pages 3 & 26)



**Cable End**



**Right Angle**

# MEGA-CON-X® FIELD INSTALLABLE CONNECTORS

## Quick Connect Type

## Threaded Type

### Dimensions (Dimensions in brackets are in millimeters)



### Panel Cutout



### Molded Cable Assemblies (See pages 3 & 26)



\* Please visit the product pages on our website for the most up-to-date product information

# MEGA-CON-X® FIELD INSTALLABLE CONNECTORS

## Part Number to Order

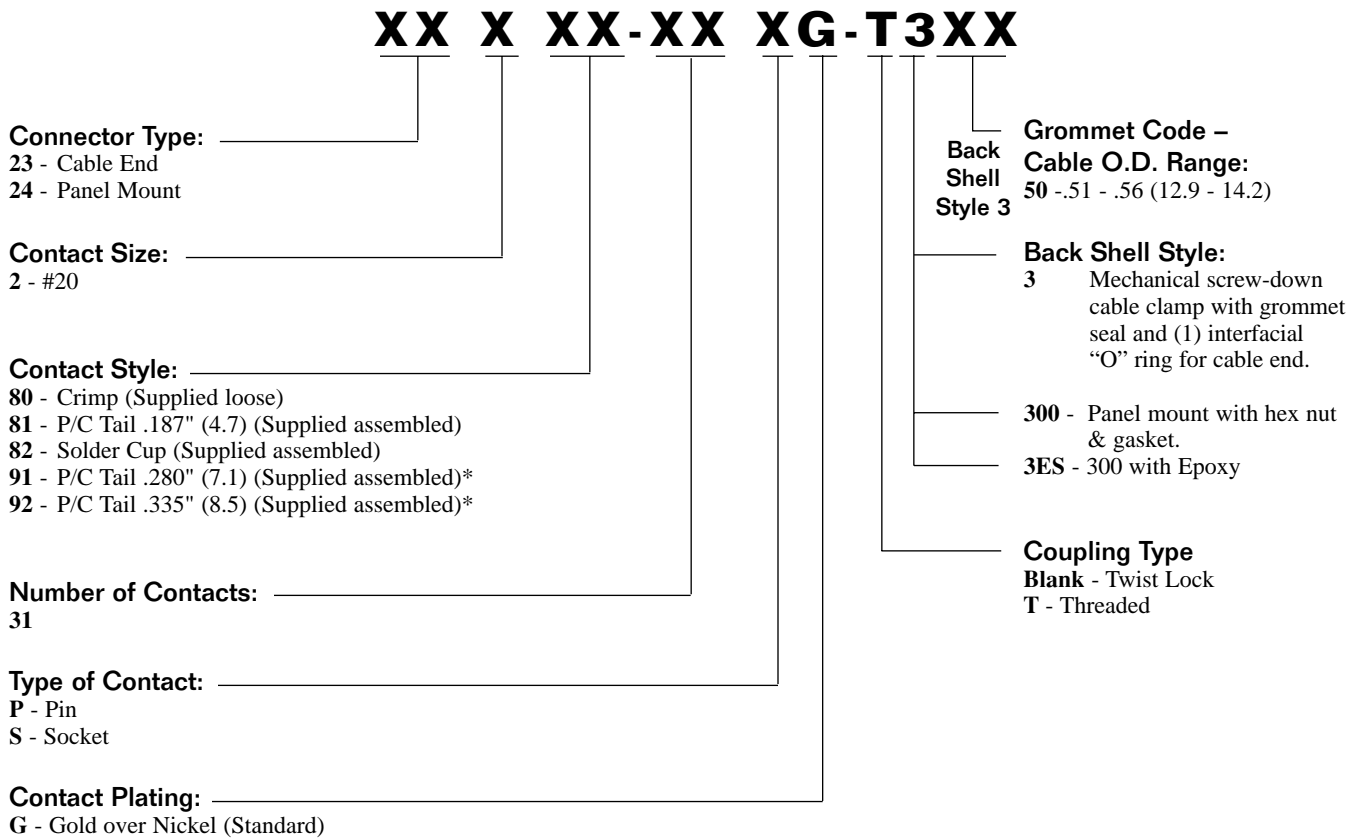

\*Available in #20 size contact only.

Consult factory for your custom design cable assemblies and connectors. (See pages 3 & 26)

## Contact Arrangements

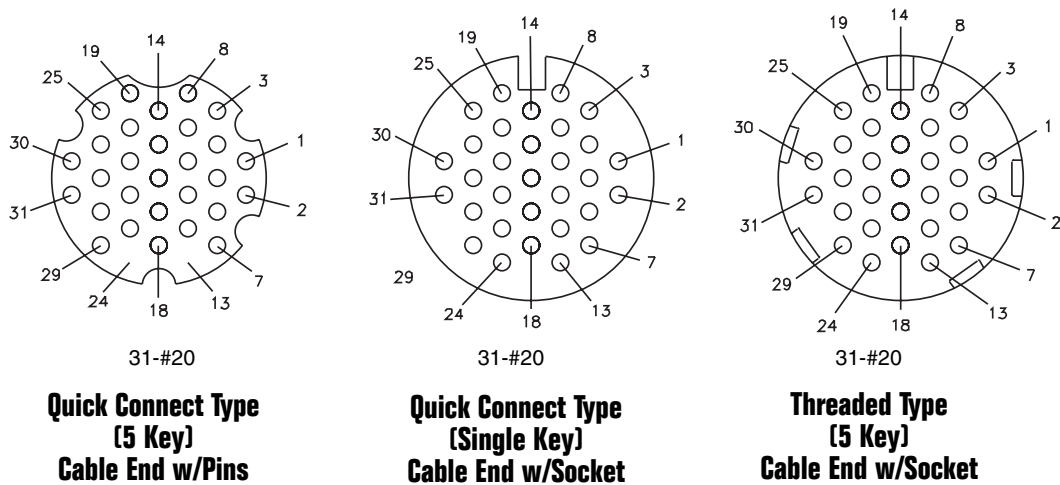

Contact arrangements shown are wiring view of cable end pins/sockets.  
Key/keyway shown for orientation only.



# MEGA-CON-X® FIELD INSTALLABLE CONNECTORS

## Specifications

### Typical Specifications

|                               |   |
|-------------------------------|---|
| Manufacturers Identifications | Mega-Con-X®   |
| Description                   | Field Installable Connector & Custom Cable Assemblies                   |
| Rating                        | 0.9 thru 2.3A, 600V   |
| Conductor Size                | 20 thru 24 AWG  |
| Configuration                 | 31 - #20 Contacts   |
| Certification                 | UL Recognized File #E150822 - 250V<br>CSA Certified File #181200 - 600V |

### Material Specifications

#### Cable Pin/Socket

|                                 |                             |
|---------------------------------|-----------------------------|
| Mechanical Backshell (Threaded) | Nylon, UL Recognized, Black |
| Strap                           | Nylon, UL Recognized, Black |
| Screws                          | Stainless Steel             |
| Grommet                         | Santoprene Rubber, Black    |
| Coupling Ring                   | Nylon, UL Recognized, Black |
| Contacts                        | Brass, Gold over Nickel     |
| Connector Body                  | Nylon, UL Recognized, Black |
| O-Ring                          | Neoprene Rubber, Black      |

#### Panel Mount

|            |                             |
|------------|-----------------------------|
| Contacts   | Brass, Gold over Nickel     |
| Panel Body | Nylon, UL Recognized, Black |
| Gasket     | Neoprene Rubber, Black      |
| Hex Nut    | Nylon, UL Recognized, Black |

Gasket, O-Ring, & Grommet materials are suitable for -40°C to +90°C (-40°F to +194°F). Consult factory for higher temperature requirements.

### Mechanical Specifications

|                |  |
|----------------|--|
| Durability     | Minimum 300 mate/unmate cycles without mechanical or electrical failure                        |
| Vibration      | Coupling rings have overriding locking feature to prevent loosening or separation of connector |
| Hex Nut Torque | All series hex nut to withstand 10-12 inch/lb tightening torque                                |

### Electrical Specifications

|         |   |
|---------|---|
| Voltage | 600V  |
| Current | See Electrical Current Rating Chart (Page 27) |

### Environmental Specifications

|                    |   |
|--------------------|---|
| Temperature Rating | -40°C to +115°C (-40°F to +239°F)         |
| Corrosion          | 300 Hr salt spray contacts                |
| Weathertight       | Consult factory with specific application |

### Molded Cable Assemblies

|            |   |
|------------|---|
| Watertight | (See Pages 3 & 26)<br>NEMA 6P, 13: IEC IP67 |
|------------|---|

\* Please visit the product pages on our website for the most up-to-date product information

# CON-X MOLDED CABLE ASSEMBLY CHECK LIST

Company Name: \_\_\_\_\_ Customer Name: \_\_\_\_\_

Address: \_\_\_\_\_

City \_\_\_\_\_ State: \_\_\_\_\_ Zip: \_\_\_\_\_

Phone: \_\_\_\_\_ Fax: \_\_\_\_\_

Website: \_\_\_\_\_ E-mail: \_\_\_\_\_

Annual Usage Quantity: \_\_\_\_\_ Monthly Usage Quantity: \_\_\_\_\_

Does the assembly need to be RoHS compliant? Yes: \_\_\_\_\_ No: \_\_\_\_\_

Cable Vendor and Part Number (if available): \_\_\_\_\_

Cable Outer Jacket - Color: \_\_\_\_\_ Material: \_\_\_\_\_ OD: \_\_\_\_\_

Number of Conductors: \_\_\_\_\_ Conductor AWG: \_\_\_\_\_ Stranding: \_\_\_\_\_

Conductor Colors: \_\_\_\_\_

Is there a drain wire? \_\_\_\_\_ Is the drain wire terminated? \_\_\_\_\_

\*If the drain wire is terminated, be sure to indicate where on pin-out diagram.

Is the cable shielded? \_\_\_\_\_ How? Foil \_\_\_\_\_ Braid \_\_\_\_\_ %

\*If the shield is braided, be sure to indicate where on the pin-out diagram.

Will the Customer supply the cable for production? \_\_\_\_\_

Cable Cut Length: \_\_\_\_\_ Overall Assembly Length: \_\_\_\_\_

Does the Cable Assembly have Environmental Requirements? \_\_\_\_\_

If yes, please list them: \_\_\_\_\_

Must overmold have a moisture bond to the cable's outer jacket? \_\_\_\_\_

Is the Cable Assembly: Single ended: \_\_\_\_\_ Double Ended: \_\_\_\_\_

Do the connectors need to be shielded? \_\_\_\_\_

If yes, do they need to be: 180° shield: \_\_\_\_\_ OR Shield thru pin: \_\_\_\_\_

End "A" Connector Part Number: \_\_\_\_\_ Right Angle? \_\_\_\_\_

End "B", will that end need processing? \_\_\_\_\_ If yes, indicate below: \_\_\_\_\_

Outer jacket strip length: \_\_\_\_\_ Inner Conductor strip length: \_\_\_\_\_ Tinned? \_\_\_\_\_

Does end "B" have any special inclusions? If yes, please list them: \_\_\_\_\_

\_\_\_\_\_

\_\_\_\_\_

Note: Please submit a diagram of the color code pin-out, showing which conductors are wired to which pin position. Be sure to show drain and shield terminations, if needed. Indicate empty pins or spaces to be molded closed where required. If a drawing assembly is available, please send it also.

# CON-X ELECTRICAL CURRENT RATING CHART FOR CONNECTORS & CABLE ASSEMBLIES

| CONTACT SIZE | CONDUCTOR SIZE - AWG | NUMBER of CONDUCTORS | CURRENT RATING |
|--------------|----------------------|----------------------|----------------|
| #12          | #12                  | 1 through 7          | 23.0A          |
|              | #14                  | 1 through 3          | 17.0A          |
|              |                      | 4 through 6          | 12.75A         |
|              |                      | 7 through 9          | 11.0A          |
|              | #16                  | 1 through 3          | 13.0A          |
|              |                      | 4 through 6          | 9.75A          |
|              |                      | 7                    | 8.45A          |
| #16          | #16                  | 1 through 10         | 13.0A          |
|              |                      | 11 and 12            | 7.5A           |
|              | #18                  | 1 through 3          | 10.0A          |
|              |                      | 4 through 12         | 7.5A           |
| #20          | #18                  | 1 through 3          | 7.5A           |
|              |                      | 4 through 20         | 5.6A           |
|              |                      | 21 through 31        | 2.3A           |
|              | #20                  | 1 through 3          | 7.5A           |
|              |                      | 4 through 20         | 5.6A           |
|              |                      | 21 through 31        | 2.3A           |

Max. Number and Size of Contacts per Series:

- 4 - #12 Multi-Con-X
- 7 - #12 Maxi-Con-X
- 5 - #16 Mini-Con-X
- 6 - #16 Multi-Con-X
- 12 - #16 Maxi-Con-X
- 3 - #20 Micro-Con-X
- 8 - #20 Mini-Con-X
- 9 - #20 Multi-Con-X
- 20 - #20 Maxi-Con-X
- 31 - #20 Mega-Con-X

\* Please visit the product pages on our website for the most up-to-date product information

# MIL-E-QUAL® EQUIVALENT TO MIL-C-5015



**Cable Socket**  
CXX 3106A XXXX XX S XXX



**Box Receptacle Pin**  
CXX 3102A XXXX XX P XXX



**Cable Pin**  
CXX 3106A XXXX XX P XXX



**Box Receptacle Socket**  
CXX 3102A XXXX XX S XXX



**Cable Cap**  
4XX96



**Receptacle Cap**  
4XX95

## Molded Cable Assemblies (See pages 3 & 33)



**Cable Pin**

# MIL-E-QUAL® EQUIVALENT TO MIL-C-5015

| Connector Size | L             | N             | Q             | V Fitting Threads |
|----------------|---------------|---------------|---------------|-------------------|
|                | INCH<br>MM    | INCH<br>MM    | INCH<br>MM    |                   |
| 10SL           | 1.800<br>45.7 | 1.200<br>30.5 | .900<br>22.9  | 1/2-20            |
| 12S            | 1.900<br>48.3 | 1.200<br>30.5 | 1.000<br>25.4 | 5/8-24            |
| 14S            | 1.900<br>48.3 | 1.300<br>33   | 1.200<br>30.5 | 3/4-20            |
| 16S            | 2.200<br>56.  | 1.425<br>36.2 | 1.250<br>31.8 | 7/8-20            |
| 16             | 2.400<br>61.  | 1.425<br>36.2 | 1.250<br>31.8 | 7/8-20            |
| 18             | 2.570<br>65.3 | 1.425<br>36.2 | 1.420<br>36.1 | 1-20              |
| 20             | 2.450<br>62.2 | 1.425<br>36.2 | 1.450<br>36.8 | 1-1/8-18          |
| 22             | 2.450<br>62.2 | 1.425<br>36.2 | 1.600<br>40.6 | 1-1/4-18          |
| 24             | 2.570<br>65.3 | 1.425<br>36.2 | 1.725<br>43.8 | 1-3/8-18          |
| 28             | 2.570<br>65.3 | 1.425<br>36.2 | 1.975<br>50.2 | 1-5/8-18          |

| Connector Size | A Coupling Threads | K           | L             | M             | R              | S              | C            | Z             |
|----------------|--------------------|-------------|---------------|---------------|----------------|----------------|--------------|---------------|
|                |                    | Inch<br>MM  | Inch<br>MM    | Inch<br>MM    | Inch<br>MM     | Inch<br>MM     | Inch<br>MM   | Inch<br>MM    |
| 10SL           | 5/8-24             | .080<br>2   | .940<br>23.9  | 9/16<br>14.3  | 23/32<br>18.3  | 1<br>25.4      | 3.5<br>88.9  | .635<br>16.1  |
| 12S            | 3/4-20             | .080<br>2   | 1.030<br>26.2 | 9/16<br>14.3  | 13/16<br>20.6  | 1-3/32<br>27.8 | 3.5<br>88.9  | .760<br>19.3  |
| 14S            | 7/8-20             | .080<br>2   | 1.143<br>29   | 9/16<br>14.3  | 29/32<br>23    | 1-3/16<br>30.2 | 3.5<br>88.9  | .885<br>22.5  |
| 16S            | 1-20               | .142<br>3.6 | 1.180<br>30   | 9/16<br>14.3  | 31/32<br>24.6  | 1-9/32<br>32.5 | 3.5<br>88.9  | 1.010<br>25.7 |
| 16             | 1-20               | .142<br>3.6 | 1.350<br>34.3 | 3/4<br>19     | 31/32<br>24.6  | 1-9/32<br>32.5 | 3.5<br>88.9  | 1.010<br>25.7 |
| 18             | 1-1/8-18           | .142<br>3.6 | 1.330<br>33.8 | 3/4<br>19     | 1-1/16<br>27   | 1-3/8<br>34.9  | 5.0<br>127.0 | 1.135<br>28.8 |
| 20             | 1-1/4-18           | .142<br>3.6 | 1.330<br>33.8 | 3/4<br>19     | 1-5/32<br>29.4 | 1-1/2<br>38.1  | 5.0<br>127.0 | 1.260<br>32.0 |
| 22             | 1-3/8-18           | .142<br>3.6 | 1.220<br>31.0 | 3/4<br>19     | 1-1/4<br>31.8  | 1-5/8<br>41.3  | 5.0<br>127.0 | 1.385<br>35.2 |
| 24             | 1-1/2-18           | .142<br>3.6 | 1.220<br>31.0 | 13/16<br>20.6 | 1-3/8<br>34.9  | 1-3/4<br>44.5  | 6.0<br>152.4 | 1.510<br>38.4 |
| 28             | 1-3/4-18           | .142<br>3.6 | 1.220<br>31.0 | 13/16<br>20.6 | 1-9/16<br>39.7 | 2<br>50.8      | 6.0<br>152.4 | 1.760<br>44.7 |

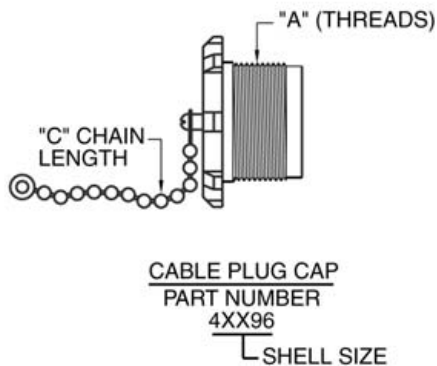

# MIL-E-QUAL® EQUIVALENT TO MIL-C-5015

## Contact Arrangements



Contact Arrangements shown are mating view of pin insert (socket opposite).

Unless otherwise specified, arrangements are per MIL-STD-1651A. for alternate key positions, consult factory.

\*Available in connector types: cable end socket, panel mount pin styles only.

# MIL-E-QUAL® EQUIVALENT TO MIL-C-5015

## Part Number to Order

**CX X 310XA XXXX XX X XXX**

**CONXALL**

Molded Equivalent to MIL-C-5015

**Contact Style**

S - Solder  
C - Crimp

**Shell Type**

(See Note 1)

**3101A** Cable Receptacle (in-line)  
(See Note 3)

**3102A** Box Receptacle

**3106A** Straight Plug (See Note 2)

Note 1 - All plugs and receptacles include crimp or solder contacts specified.

Note 2 - Straight Plugs include back shell assembly with cable clamp and bushing.

Note 3 - For overmolded cable construction only. Consult factory for availability.

**Deviations**

**-300** Weathertight  
Option adds:  
"O" Ring for plug (3106A)  
Rubber Gasket for receptacle (3102A)

**-010** Receptacle with (4) mounting hole reinforcement bosses. Consult factory for availability.

**-310** Same as -010 except with rubber gasket.

**Contacts**

P - Pin  
S - Socket

**Insert Number/Arrangement**

All inserts are integrally molded with connector shells for one piece construction. Contact factory for alternative W, X, Y or Z insert positions.

**Shell/Insert Sizes**

|         |         |       |
|---------|---------|-------|
| 10SL-4  | 16S-1   | 18-19 |
| 10SL-3  | 16S-8   | 20-7  |
| 12S - 3 | 16 - 10 | 20-16 |
| 14S - 1 | 18 - 1  | 20-27 |
| 14S - 2 | 18 - 4  | 20-29 |
| 14S - 5 | 18 - 8  | 22-14 |
| 14S - 6 | 18 - 10 | 24-2  |
| 14S - 7 | 18 - 11 | 24-28 |
| 14S - 9 | 18 - 12 | 28-2  |
|         |         | 28-12 |
|         |         | 28-21 |

**Bushing Sizes Provided**

| Plug Shell Size | Max. Cable Dia. |
|-----------------|-----------------|
| 10SL, 12S       | 1/4"            |
| 14S             | 5/16"           |
| 16S, 16         | 7/16"           |
| 18              | 9/16"           |
| 20, 22          | 5/8"            |
| 24, 28          | 3/4"            |

Consult factory for your custom design assemblies and connectors. (See pages 3 & 33)

# MIL-E-QUAL® EQUIVALENT TO MIL-C-5015

## Specifications

### Typical Specifications

|                               |   |
|-------------------------------|---|
| Manufacturers Identifications | MIL-E-QUAL®   |
| Description                   | Field Installable Connector & Custom Cable Assemblies                 |
| Rating                        | 3.4 thru 23.0A, 600V  |
| Conductor Size                | 12 thru 20 AWG  |
| Configuration                 | 2 thru 37 Contacts per Mil - C-5015                                   |
| Certification                 | UL Recognized File #E150822 - 250V<br>CSA Certified File #181200-500V |

### Material Specifications

#### Cable Pin/Socket

|                                 |   |
|---------------------------------|---|
| Mechanical Backshell (Threaded) | Nylon, UL Recognized, Black with UV Inhibitor       |
| Strap                           | Nylon, UL Recognized, Black with UV Inhibitor       |
| Screws                          | Zinc Plated   |
| Grommet                         | Santoprene Rubber, Black                            |
| Coupling Ring                   | Nylon, UL Recognized, Black with UV Inhibitor       |
| Contacts                        | Brass, Standard Silver Plated, Gold Plated Optional |
| Connector Body                  | Nylon, UL Recognized, Black with UV Inhibitor       |

#### Optional

|               |   |
|---------------|---|
| Connector Cap | Nylon, UL Recognized, Black with UV Inhibitor (4XX96) |
| O-Ring        | Neoprene Rubber, Black                                |

Different Keyways Available

Gold Contacts

Brass, Gold over Nickel

#### Box Receptacle

|                 |   |
|-----------------|---|
| Contacts        | Brass, Standard Silver Plated, Gold Plated Optional |
| Receptacle Body | Nylon, UL Recognized, Black with UV Inhibitor       |

#### Optional

|                |   |
|----------------|---|
| Receptacle Cap | Nylon, UL Recognized, Black with UV Inhibitor (4XX95) |
| Gasket         | Neoprene Rubber, Black                                |
| Gold Contacts  | Brass, Gold over Nickel                               |

Extended Bosses

Different Keyways Available

Gasket, O-Ring, & Grommet materials are suitable for -40°C to +90°C (-40°F to +194°F). Consult factory for higher temperature requirements.

### Electrical Specifications

|         |   |
|---------|---|
| Voltage | 500 V   |
| Current | See Electrical Current Rating Chart (Page 34) |

### Environmental Specifications

|                    |   |
|--------------------|---|
| Temperature Rating | -40°C to +125°C (-40°F to +257°F)         |
| Corrosion          | 48 Hr salt spray contacts                 |
| Durability         | 300 mate/unmate cycles minimum            |
| Weathertight       | Consult factory with specific application |

### Molded Cable Assemblies

|            |   |
|------------|---|
| Watertight | (See Pages 3 & 33)<br>NEMA 6P, 13: IEC IP67 |
|------------|---|



## MIL-E-QUAL® MOLDED CABLE ASSEMBLY CHECK LIST EQUIVALENT TO MIL-C-5015

Company Name: \_\_\_\_\_ Customer Name: \_\_\_\_\_

Address: \_\_\_\_\_

City \_\_\_\_\_ State: \_\_\_\_\_ Zip: \_\_\_\_\_

Phone: \_\_\_\_\_ Fax: \_\_\_\_\_

Website: \_\_\_\_\_ E-mail: \_\_\_\_\_

Annual Usage Quantity: \_\_\_\_\_ Monthly Usage Quantity: \_\_\_\_\_

Does the assembly need to be RoHS compliant? Yes: \_\_\_\_\_ No: \_\_\_\_\_

Cable Vendor and Part Number (if available): \_\_\_\_\_

Cable Outer Jacket - Color: \_\_\_\_\_ Material: \_\_\_\_\_ OD: \_\_\_\_\_

Number of Conductors: \_\_\_\_\_ Conductor AWG: \_\_\_\_\_ Stranding: \_\_\_\_\_

Conductor Colors: \_\_\_\_\_

Is there a drain wire? \_\_\_\_\_ Is the drain wire terminated? \_\_\_\_\_

\*If the drain wire is terminated, be sure to indicate where on pin-out diagram.

Is the cable shielded? \_\_\_\_\_ How? Foil \_\_\_\_\_ Braid \_\_\_\_\_ % \_\_\_\_\_

\*If the braid is terminated, be sure to indicate where on the pin-out diagram.

Will the Customer supply the cable for production? \_\_\_\_\_

Cable Cut Length: \_\_\_\_\_ Overall Assembly Length: \_\_\_\_\_

Does the Cable Assembly have Environmental Requirements? \_\_\_\_\_

If yes, please list them: \_\_\_\_\_

Must overmold have a moisture bond to the cable's outer jacket? \_\_\_\_\_

Is the Cable Assembly: Single ended: \_\_\_\_\_ Double Ended: \_\_\_\_\_

Do the connectors need to be shielded? \_\_\_\_\_

If yes, do they need to be: 180° shield: \_\_\_\_\_ OR Shield thru pin: \_\_\_\_\_

End "A" Connector Part Number: \_\_\_\_\_ Right Angle? \_\_\_\_\_

End "B" Connector Part Number: \_\_\_\_\_ Right Angle? \_\_\_\_\_

If no conductor on end "B", will that need processing? \_\_\_\_\_ If yes, indicate below:

Outer jacket strip length: \_\_\_\_\_ Inner Conductor strip length: \_\_\_\_\_ Tinned? \_\_\_\_\_

Does end "B" have any special inclusions? If yes, please list them: \_\_\_\_\_

Note: Please submit a diagram of the color code pin-out, showing which conductors are wired to which pin position. Be sure to show drain and shield terminations, if needed. Indicate empty pins or spaces to be molded closed where required. If a drawing assembly is available, please send it also.

# MIL-E-QUAL® ELECTRICAL CURRENT RATING CHART FOR CONNECTORS & CABLE ASSEMBLIES

| Contact Size  | Conductor Size - AWG | Number of Conductors | Current Rating |
|---------------|----------------------|----------------------|----------------|
| #12           | #12                  | 1 through 3          | 23.0A          |
|               |                      | 4 through 6          | 17.0A          |
|               |                      | 7 through 9          | 13.0A          |
| #12           | #14                  | 1 through 3          | 17.0A          |
|               |                      | 4 through 6          | 12.75A         |
|               |                      | 7 through 9          | 11.0A          |
| #12           | #16                  | 1 through 3          | 13.0A          |
|               |                      | 4 through 6          | 9.75A          |
|               |                      | 7 through 9          | 8.45A          |
| #16           | #16                  | 1 through 3          | 13.0A          |
|               |                      | 4 through 6          | 9.75A          |
|               |                      | 7 through 10         | 8.45A          |
|               |                      | 10 through 20        | 5.85A          |
|               |                      | 21 through 30        | 4.55A          |
|               | #18                  | 31 and up            | 3.9A           |
|               |                      | 1 through 3          | 10.0A          |
|               |                      | 4 through 6          | 7.5A           |
|               | #20                  | #18                  | 7 through 9    |
| 10 through 20 |                      |                      | 4.5A           |
| 21 through 30 |                      |                      | 3.5A           |
| 31 and up     |                      |                      | 3.0A           |
| #20           |                      |                      | #20            |
|               | 4 through 6          | 5.6A                 |                |
|               | 7 through 9          | 4.8A                 |                |
|               | 10 through 20        | 3.4A                 |                |
|               | 21 through 30        | 2.62A                |                |
|               |                      | 31 and up            | 2.3A           |

## TOOLING

### Contact Insertion & Removal Tools



356-XXX Bits



356-1 Handle

**Manual Crimp Tool**  
(Multi-contact)



Handle

Positioner

**Manual Crimp Tool**  
(Single Purpose)



Locator

Handle

# TOOLING

## Contact Insertion/Removal Tools

| Con-X Series | Connector Size | Contact Size    | Insertion Bits Pins or Sockets | Handle for Bits |
|--------------|----------------|-----------------|--------------------------------|-----------------|
|              | 2-7 contacts   | #12 .093" (2.4) | 356-12                         | 356-1           |
|              | 2-10 contacts  | #16 .062" (1.6) | 356-16                         | 356-1           |
|              | 2-31 contacts  | #20 .040" (1)   | 356-20                         | 356-1           |

| MIL-E-QUAL Series | Connector Size  | Contact Size    | Insertion Bits Pins or Sockets | Handle for Bits |
|-------------------|-----------------|-----------------|--------------------------------|-----------------|
|                   | All Mil-E-Qual  | #12 .093" (2.4) | 356-12                         | 356-1           |
|                   | Connector Sizes | #16 .062" (1.6) | 356-16                         | 356-1           |

Product not designed to remove contacts after insertion. Consult factory for removal tools.

## Manual Contact Crimping Tools

| Con-X Series | Contact Size    | Handle for Tool | Description         | Contact Positioners for Tools |
|--------------|-----------------|-----------------|---------------------|-------------------------------|
|              | #12, #16, & #20 | 359-24          | Multi Contact Tool  | 357-124                       |
|              | #20 Only        | 359-21          | Single Purpose Tool | 357-122                       |

| MIL-E-QUAL Series | Contact Size    | Handle for Tool | Description     | Contact Positioners for Tools |
|-------------------|-----------------|-----------------|-----------------|-------------------------------|
|                   | #12 .093" (2.4) | 359-24          | Hand Crimp Tool | 358-112                       |
|                   | #16 .062" (1.6) | 359-24          | Hand Crimp Tool | 358-112                       |

## Pneumatic Crimping Tools - Consult Factory

### Contact Crimping and Assembly Procedures:

- A. Push cable through connector components, i.e. backshell, grommet, sleeve, and coupling ring.
- B. Wire preparation: Strip cable to dimensions shown. Make all cuts square and sharp being careful not to nick wires when cutting. To prevent stranded wires from fraying it is recommended that ends be tightly twisted and not solder dipped.

### Conductor Strip Lengths

| CON-X     | MIL-E-QUAL |
|-----------|------------|
| #20 -3/16 | #16 -9/32  |
| #16 -7/32 | #12 -7/32  |
| #12 -7/32 |            |



Cable Stripping

- C. Contact crimping tools, use as follows:
  - Assemble contact locator to tool.
  - Check tool setting for wire gage to be crimped.
  - Drop contacts, mating end first into locator so that it rests fully on bottom. Insert stripped lead into contact barrel until it stops.
  - Close tool handles completely in one stroke. (The ratchet will not release jaws until tool has completed cycle.)
  - Inspect crimp to be sure there are no loose strands outside the contact which may short out to an adjacent contact.
- D. Contact insertion tools. Place wired contact into proper connectors cavity. Guide tip of the insertion tool so that it starts at the contact and slides down against the stop. Apply a steady force perpendicular to the contact until it snaps into position.

\* Please visit the product pages on our website for the most up-to-date product information

# NOTES

Компания «Океан Электроники» предлагает заключение долгосрочных отношений при поставках импортных электронных компонентов на взаимовыгодных условиях!

Наши преимущества:

- Поставка оригинальных импортных электронных компонентов напрямую с производств Америки, Европы и Азии, а так же с крупнейших складов мира;
- Широкая линейка поставок активных и пассивных импортных электронных компонентов (более 30 млн. наименований);
- Поставка сложных, дефицитных, либо снятых с производства позиций;
- Оперативные сроки поставки под заказ (от 5 рабочих дней);
- Экспресс доставка в любую точку России;
- Помощь Конструкторского Отдела и консультации квалифицированных инженеров;
- Техническая поддержка проекта, помощь в подборе аналогов, поставка прототипов;
- Поставка электронных компонентов под контролем ВП;
- Система менеджмента качества сертифицирована по Международному стандарту ISO 9001;
- При необходимости вся продукция военного и аэрокосмического назначения проходит испытания и сертификацию в лаборатории (по согласованию с заказчиком);
- Поставка специализированных компонентов военного и аэрокосмического уровня качества (Xilinx, Altera, Analog Devices, Intersil, Interpoint, Microsemi, Actel, Aeroflex, Peregrine, VPT, Syfer, Eurofarad, Texas Instruments, MS Kennedy, Miteq, Cobham, E2V, MA-COM, Hittite, Mini-Circuits, General Dynamics и др.);

Компания «Океан Электроники» является официальным дистрибьютором и эксклюзивным представителем в России одного из крупнейших производителей разъемов военного и аэрокосмического назначения «JONHON», а так же официальным дистрибьютором и эксклюзивным представителем в России производителя высокотехнологичных и надежных решений для передачи СВЧ сигналов «FORSTAR».



## JONHON

«JONHON» (основан в 1970 г.)

Разъемы специального, военного и аэрокосмического назначения:

(Применяются в военной, авиационной, аэрокосмической, морской, железнодорожной, горно- и нефтедобывающей отраслях промышленности)

«FORSTAR» (основан в 1998 г.)

ВЧ соединители, коаксиальные кабели, кабельные сборки и микроволновые компоненты:

(Применяются в телекоммуникациях гражданского и специального назначения, в средствах связи, РЛС, а так же военной, авиационной и аэрокосмической отраслях промышленности).



Телефон: 8 (812) 309-75-97 (многоканальный)

Факс: 8 (812) 320-03-32

Электронная почта: [ocean@oceanchips.ru](mailto:ocean@oceanchips.ru)

Web: <http://oceanchips.ru/>

Адрес: 198099, г. Санкт-Петербург, ул. Калинина, д. 2, корп. 4, лит. А