

## PFM/PWM Step-Up DC/DC Converter

### Features

- High Efficiency at Low Output Load Currents via PFM Mode
- Assured Start-up at 0.9V
- 80  $\mu$ A (Typ) Supply Current
- 85% Typical Efficiency at 100 mA
- 140 mA Typical Output Current @  $V_{IN} = 2.0V$
- Low Power Shutdown Mode
- No External Switching Transistor Needed
- Space-Saving SOT-89 Package

### Applications

- Pagers
- Cellular Phones
- Palmtops
- 1-Cell to 3-Cell Battery Powered Systems
- Cameras, Video Recorders
- Local +3V to +5V Supplies

### Package Type

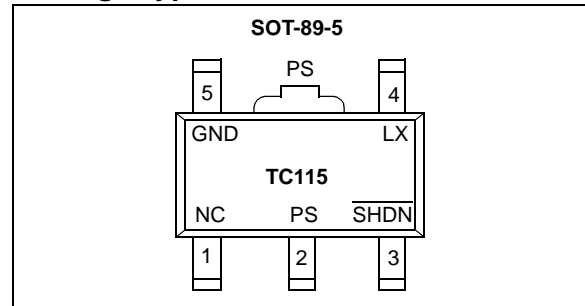

### General Description

The TC115 is a high-efficiency step-up DC/DC converter for small, low input voltage or battery-powered systems. This device has a start-up voltage of 0.9V and a typical supply current of 80  $\mu$ A. Phase compensation and soft-start circuitry are included on-chip. Unlike conventional PWM step-up converters, the TC115 automatically shifts to pulse frequency modulation (PFM) at low loads, resulting in reduced supply current and improved efficiency.

The TC115 requires only an external diode, an inductor and a capacitor, while supporting typical output currents of 140 mA. Supply current is reduced to less than 0.5  $\mu$ A (max) when SHDN input is brought low.

Small size, low installed cost and low supply current make the TC115 step-up converter ideal for use in a wide range of battery-powered systems.

### Functional Block Diagram

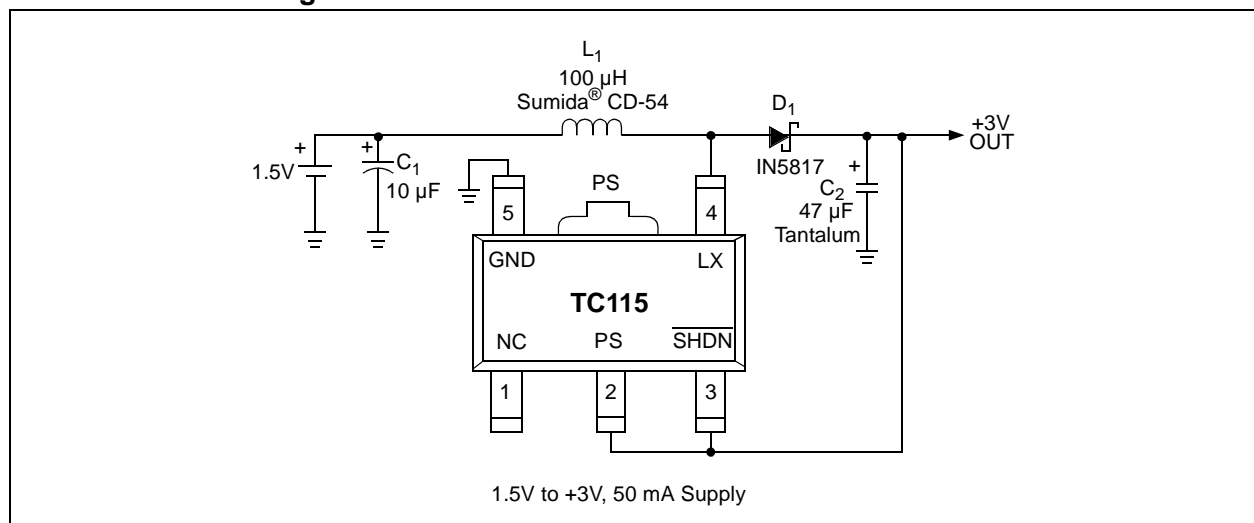

# TC115

## 1.0 ELECTRICAL CHARACTERISTICS

### Absolute Maximum Ratings†

Power Supply Voltage (PS).....	12V
Power Dissipation .....	500 mW
LX Sink Current.....	400 mA pk
SHDN Input Voltage .....	12V
Operating Temperature Range.....	-40°C to +85°C
Storage Temperature Range .....	-40°C to +125°C

† Stresses above those listed under "Absolute Maximum Ratings" may cause permanent damage to the device. These are stress ratings only and functional operation of the device at these or any other conditions above those indicated in the operation sections of the specifications is not implied. Exposure to Absolute Maximum Rating conditions for extended periods may affect device reliability.

## PIN FUNCTION TABLE

Symbol	Description
NC	Not connected
PS	Power and voltage sense input
SHDN	Shutdown input
LX	Inductor switch output
GND	Ground terminal

## DC CHARACTERISTICS

Electrical Specifications: Unless otherwise noted, $V_{OUT} = 5V$ , $T_A = +25^\circ C$ . Circuit configuration is illustrated in Figure 5-1.						
Parameters	Sym	Min	Typ	Max	Units	Conditions
Operating Supply Voltage	$V_{IN}$	0.9	—	10.0	V	<b>Note 5</b>
Start-Up Supply Voltage	$V_{START}$	—	—	0.9	V	$I_{OUT} = 1 \text{ mA}$
LX Maximum Sink Current	$I_{LXMAX}$	—	—	350	mA	
LX Limit Frequency	$f_{LIM}$	—	200	—	kHz	$V_{LX} = VLX_{LIM}$
LX Limit Voltage	$VLX_{LIM}$	0.7	—	1.3	V	<b>Note 2</b>
No Load Supply Current	$I_{DD}$	—	13	26	$\mu A$	$I_{OUT} = 0$ , $V_{IN} = V_{OUT} \times 0.8$ ( <b>Note 3</b> )
Boost Mode Supply Current	$I_{CC}$	—	80	135	$\mu A$	No external components, $V_{IN} = (0.95 \times V_{OUT})$ applied to PS (or $V_{DD}$ ) input
Standby Supply Current	$I_{STBY}$	—	9	17	$\mu A$	No external components, $V_{IN} = (1.1 \times V_{OUT})$ applied to PS (or $V_{DD}$ ) input
Shutdown Supply Current	$I_{SD}$	—	—	0.5	$\mu A$	SHDN = 0V
Oscillator Frequency	$f_{OSC}$	85	100	115	kHz	<b>Note 2, Note 4</b>
Output Voltage	$V_{OUT}$	$V_R \times 0.975$	$V_R$	$V_R \times 1.025$	V	$V_{IN} = 2.2V$ minimum ( <b>Note 1</b> )
LX Output ON Resistance	$R_{swon}$	—	1.4	2.4	$\Omega$	$V_{LX} = 0.4V$
Duty Cycle (PFM Operating Mode)	PFMDUTY	10	17	25	%	No external components
Maximum Duty Cycle	MAX-DUTY	80	87	92	%	<b>Note 4</b>
Soft Start Time	$t_{SS}$	4	10	20	msec	
Efficiency	$\eta$	—	85	—	%	
SHDN Input Logic High	$V_{IH}$	0.75	—	—	V	
SHDN Input Logic Low	$V_{IL}$	—	—	0.20	V	

- Note 1:**  $V_R$  is the nominal factory-programmed output voltage setting.  
**Note 2:**  $VLX_{LIM}$  is the voltage on the LX pin (with internal switch ON) that will cause the oscillator to run at twice nominal frequency in to limit the switch current through the internal N-channel switching transistor.  
**Note 3:** Measured with  $D_1 = MA735$  (reverse current < 1  $\mu A$  at a reverse voltage of 10V).  
**Note 4:** With TC115 operating in PWM mode.  
**Note 5:** See Section 4.4, "Behavior When  $V_{IN}$  is Greater Than the Factory-Programmed  $V_{OUT}$  Setting".

## 2.0 TYPICAL PERFORMANCE CURVES

**Note:** The graphs and tables provided following this note are a statistical summary based on a limited number of samples and are provided for informational purposes only. The performance characteristics listed herein are not tested or guaranteed. In some graphs or tables, the data presented may be outside the specified operating range (e.g., outside specified power supply range) and therefore outside the warranted range.

**Note:** Unless otherwise indicated,  $V_{OUT} = 5V$ ,  $T_A = +25^{\circ}C$ .

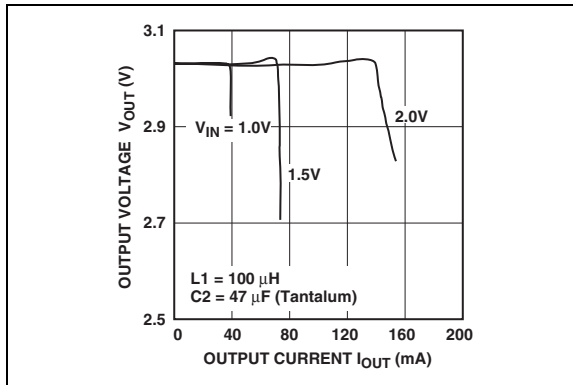

**FIGURE 2-1:** Output Voltage vs. Output Current.

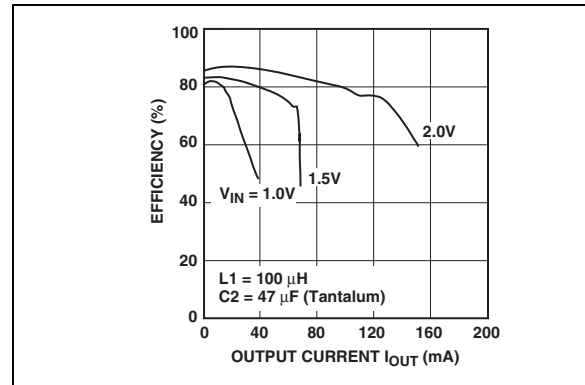

**FIGURE 2-3:** Efficiency vs. Output Current.

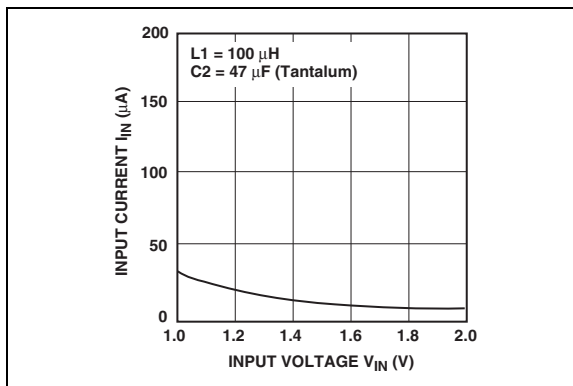

**FIGURE 2-2:** No Load Input Current vs. Input Voltage.

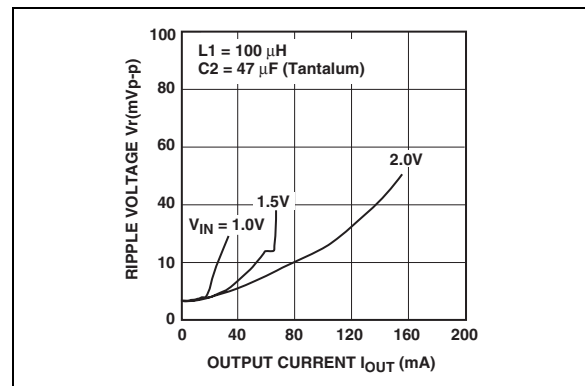

**FIGURE 2-4:** Ripple Voltage vs. Output Current.

## 3.0 PIN DESCRIPTIONS

The descriptions of the pins are listed in Table 3-1.

**TABLE 3-1: PIN FUNCTION TABLE**

Pin No.	Symbol	Description
1	NC	Not connected
2	PS	Power and voltage sense input
3	$\overline{\text{SHDN}}$	Shutdown input
4	LX	Inductor switch output
5	GND	Ground terminal

### 3.1 Power and Voltage Sense Input (PS)

PS is a dual function input that provides both feedback voltage sensing and internal chip power. It should be connected to the regulator output (See Section 5.0, "Applications").

### 3.2 Shutdown Input ( $\overline{\text{SHDN}}$ )

A logic-low on  $\overline{\text{SHDN}}$  suspends device operation and supply current is reduced to less than  $0.5 \mu\text{A}$ . The device resumes normal operation when  $\overline{\text{SHDN}}$  is again brought high.

### 3.3 Inductor Switch Output (LX)

LX is the drain of an internal N-channel switching transistor. This terminal drives the external inductor, which ultimately provides current to the load.

### 3.4 Ground Terminal (GND)

Connect to circuit ground.

### 3.5 No Connect (NC)

No internal connection.

## 4.0 DETAILED DESCRIPTION

The TC115 is a combination PFM/PWM step-up (boost) regulator. It is particularly useful in battery-powered 1, 2 and 3 cell applications where the required output current is 140 mA or less, and size/cost issues are a concern. The device operates in PWM mode when the output load is sufficient to demand a 10% (or greater) duty cycle. While in PWM mode, the TC115 behaves as any other PWM switching regulator to a maximum duty cycle of 92%. At low output loads (i.e., output loads requiring < 10% duty cycle to support), the TC115 automatically switches to pulse frequency modulation (PFM) operating mode with a fixed duty cycle of 25% (max) (17%, typical). While in PFM mode, the inductor is modulated with individual fixed width pulses only as needed to maintain output voltage. This action reduces supply current, thereby improving power efficiency at low output loads.

### 4.1 Input Power and Sensing

The TC115 is powered from the PS input, which *must* be connected to the regulated output, as shown in Figure 5-1. PS also senses output voltage for closed-loop regulation. Start-up current is furnished through the inductor when input voltage is initially applied. This action starts the oscillator, causing the voltage at the PS input to rise, bootstrapping the regulator into full operation.

### 4.2 Output Diode

For best results, use a Schottky diode, such as the MA735, 1N5817, EC10 or equivalent. Connect the diode between the PS and LX pins as close to the IC as possible. While ultra fast diodes can be used, lower efficiency will result due to their higher forward voltage drop. Ordinary rectifiers should be avoided because of their slow recovery characteristics.

### 4.3 Low Power Shutdown Mode

The TC115 enters a low power shutdown mode when  $\overline{\text{SHDN}}$  is brought low. While in shutdown, the oscillator is disabled and the internal switch is shut off. Normal regulator operation resumes when  $\overline{\text{SHDN}}$  is brought high.  $\overline{\text{SHDN}}$  may be tied to the input supply if not used.

**Note:** Because the TC115 uses an external diode, a leakage path between the input voltage and the output node (through the inductor and diode) exists while the regulator is in shutdown. Care must be taken in system design to assure the input supply is isolated from the load during shutdown.

### 4.4 Behavior When $V_{\text{IN}}$ is Greater Than the Factory-Programmed $V_{\text{OUT}}$ Setting

The TC115 is designed to operate as a step-up regulator only. As such,  $V_{\text{IN}}$  is assumed to always be less than the factory-programmed  $V_{\text{OUT}}$  setting ( $V_{\text{R}}$ ). Operating the TC115 with  $V_{\text{IN}} > V_{\text{R}}$  causes regulating action to be suspended (and corresponding supply current reduction to 9  $\mu\text{A}$ , typical) until  $V_{\text{IN}}$  is again less than  $V_{\text{R}}$ . While regulating action is suspended,  $V_{\text{IN}}$  is connected to  $V_{\text{OUT}}$  through the series combination of the inductor and Schottky diode. Care must be taken to add the appropriate isolation (MOSFET output switch or post LDO with shutdown) during system design if this  $V_{\text{IN}}/V_{\text{OUT}}$  leakage path is problematic.

## 5.0 APPLICATIONS

### 5.1 Input Bypass Capacitors

Using an input bypass capacitor reduces peak current transients drawn from the input supply and reduces the switching noise generated by the regulator. The source impedance of the input supply determines the size of the capacitor that should be used.

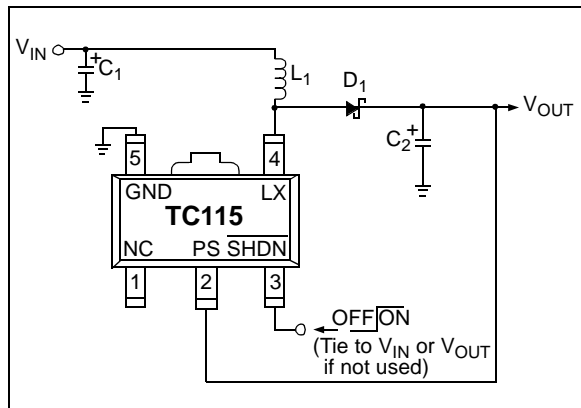

**FIGURE 5-1:** TC115 Typical Application.

### 5.2 Inductor Selection

Selecting the proper inductor value is a trade-off between physical size and power conversion requirements. Lower value inductors cost less, but result in higher ripple current and core losses. They are also more prone to saturate since the coil current ramps to a higher value. Larger inductor values reduce both ripple current and core losses, but are larger in physical size and tend to increase the start-up time slightly.

Practical inductor values, therefore, range from 50  $\mu\text{H}$  to 300  $\mu\text{H}$ . Inductors with a ferrite core (or equivalent) are recommended. For highest efficiency, use an inductor with a series resistance less than 0.1 $\Omega$ .

The inductor value directly affects the output ripple voltage. Equation 5-3 is derived as shown below, and can be used to calculate an inductor value, given the required output ripple voltage ( $V_{\text{RIPPLE}}$ ) and output capacitor series resistance:

#### EQUATION 5-1:

$$V_{\text{RIPPLE}} \approx \text{ESR}(di)$$

Where:

ESR: the equivalent series resistance of the output filter capacitor;  $V_{\text{RIPPLE}}$  is in volts.

di: represents the peak to peak ripple current in the inductor.

Expressing  $di$  in terms of switch ON resistance and time:

#### EQUATION 5-2:

$$V_{\text{RIPPLE}} \approx \frac{[(V_{\text{IN}} - V_{\text{SW}})t_{\text{ON}}]}{L}$$

Where:

$V_{\text{SW}}$  = voltage drop across the switch.

$T_{\text{ON}}$  = the amount of time the switch is ON.

Solving for L:

#### EQUATION 5-3:

$$L \approx \frac{[(V_{\text{IN}} - V_{\text{SW}})t_{\text{ON}}]}{V_{\text{RIPPLE}}}$$

Care must be taken to ensure the inductor can handle peak switching currents, which can be several times load currents. Exceeding rated peak current will result in core saturation and loss of inductance. The inductor should be selected to withstand currents greater than  $I_{\text{PK}}$  (Equation 5-10) without saturating.

Calculating the peak inductor current is straightforward. Inductor current consists of an AC (sawtooth) current centered on an average DC current (i.e., input current). Equation 5-6 calculates the average DC current. Note that minimum input voltage and maximum load current values should be used:

#### EQUATION 5-4:

$$\text{Input Power} = \frac{\text{Output Power}}{\text{Efficiency}}$$

Rewriting in terms of input and output currents and voltages:

**EQUATION 5-5:**

$$(V_{IN_{MIN}})(I_{IN_{MAX}}) = \frac{(V_{OUT_{MAX}})(I_{OUT_{MAX}})}{Efficiency}$$

Solving for input current:

**EQUATION 5-6:**

$$I_{IN_{MAX}} = \frac{(V_{OUT_{MAX}})(I_{OUT_{MAX}})}{(Efficiency)(V_{IN_{MIN}})}$$

The sawtooth current is centered on the DC current level, swinging equally above and below the DC current calculated in Equation 5-6. The peak inductor current is the sum of the DC current plus half the ac current. Note that minimum input voltage should be used when calculating the ac inductor current (Equation 5-9).

**EQUATION 5-7:**

$$V_L = L(di/dt)$$

**EQUATION 5-8:**

$$di = V_L(di/dt)$$

**EQUATION 5-9:**

$$di = \frac{(V_{IN_{MIN}} - V_{SW})t_{ON}}{L}$$

Where:  
 $V_{SW}$  = The voltage drop across the internal N-channel MOSFET.

Combining the DC current calculated in Equation 5-6, with half the peak ac current calculated in Equation 5-9, the peak inductor current is given by:

**EQUATION 5-10:**

$$I_{PK} = I_{IN_{MAX}} + 0.5(di)$$

### 5.3 Internal Transistor Switch

The LX pin has a typical ON resistance of 1.4Ω. Therefore, peak switch current is given by  $(V_{IN}/1.4)$ . The internal transistor switch has a maximum design rating of 350 mA. An oscillator frequency doubling circuit is included guard against high switching currents. Should the voltage on the LX pin rise above 1.3V (max) while the internal N-channel switch is ON, the oscillator frequency automatically doubles to minimize ON time. Although reduced, switch current still flows because the PWM remains in operation. *Therefore, the LX input is not internally current-limited and care must be taken never to exceed the 350 mA maximum limit.* Failure to observe this will result in damage to the regulator.

### 5.4 Output Capacitor

The effective series resistance of the output capacitor directly affects the amplitude of the output voltage ripple (The product of the peak inductor current and the ESR determines output ripple amplitude). Therefore, a capacitor with the lowest possible ESR should be selected. Smaller capacitors are acceptable for light loads (or in applications where ripple is not a concern). The Sprague® 595D series of tantalum capacitors are among the smallest of all low ESR surface mount capacitors available. Table 5-1 lists suggested components and suppliers.

### 5.5 Board Layout Guidelines

As with all inductive switching regulators, the TC115 generates fast switching waveforms which radiate noise. Interconnecting lead lengths should be minimized to keep stray capacitance, trace resistance and radiated noise as low as possible. In addition, the GND pin, input bypass capacitor and output filter capacitor ground leads should be connected to a single point.

**TABLE 5-1: SUGGESTED COMPONENTS AND SUPPLIERS**

Type	Inductors	Capacitors	Diodes
Surface Mount	Sumida® CD54 Series CDR125 Series Coiltronics™ CTX Series	Matsuo® 267 Series Sprague® 595D Series Nichicon™ F93 Series	Nihon EC10 Series Matsushita™ MA735 Series
Through-Hole	Sumida® RCH855 Series RCH110 Series Renco® RL1284-12	Sanyo™ OS-CON Series Nichicon™ PL Series	ON Semiconductor® 1N5817 - 1N5822

**TC115301**  
 $V_{IN} = 1.0V$   
 $I_{LOAD} = 10\text{ mA}$   
 CH1:  $V_{OUT}$  (DC)  
 CH2:  $V_{OUT}$  (AC Ripple)  
 $L = 100\ \mu H$   
 $C = 47\ \mu F$   
 $D1 = MA735$

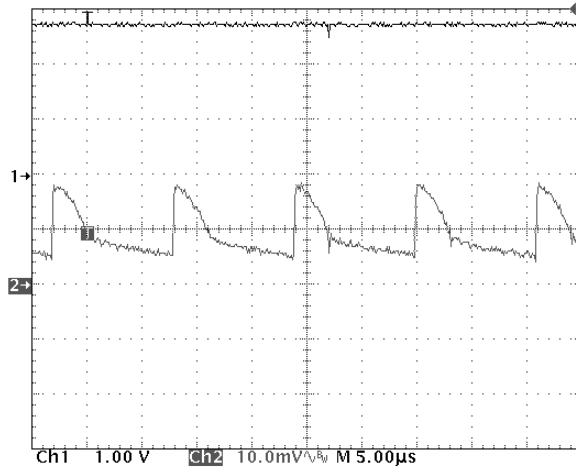

**TC115301**  
 $V_{IN} = 2.0V$   
 $I_{LOAD} = 40\text{ mA}$   
 CH1:  $V_{OUT}$  (DC)  
 CH2:  $V_{OUT}$  (AC Ripple)  
 $L = 100\ \mu H$   
 $C = 47\ \mu F$   
 $D1 = MA735$

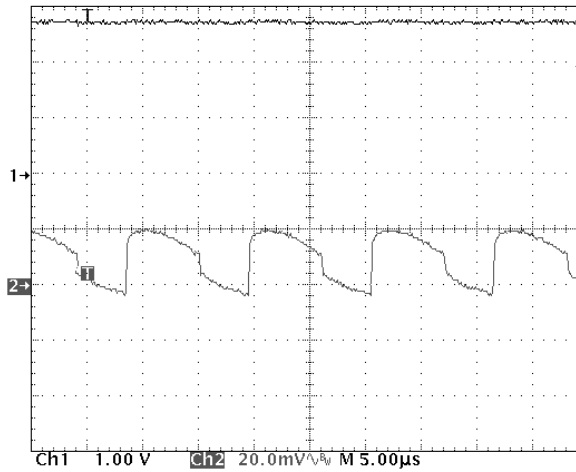

**TC115301**  
 $V_{IN} = 2.5V$   
 $I_{LOAD} = 80\text{ mA}$   
 CH1:  $V_{OUT}$  (DC)  
 CH2:  $V_{OUT}$  (AC Ripple)  
 $L = 100\ \mu H$   
 $C = 47\ \mu F$   
 $D1 = MA735$

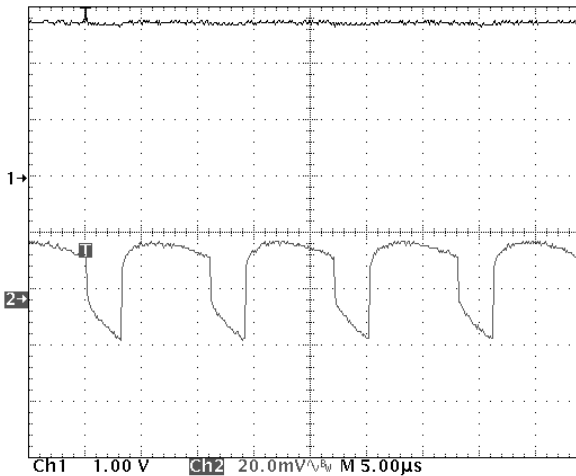
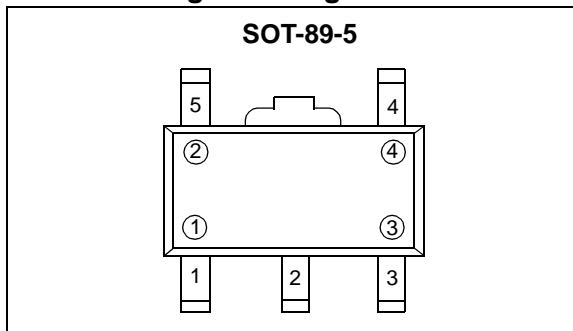

**FIGURE 5-2:** Typical Ripple Waveforms.



## 6.0 PACKAGING INFORMATION

### 6.1 Package Marking Information



① represents product classification; TC115 =  $\bar{1}$

② represents first integer of voltage and frequency

Symbol (100 kHz)	Voltage
1	1.
2	2.
3	3.
4	4.
5	5.
6	6.

③ represents first decimal of voltage and frequency

Symbol (100 kHz)	Voltage
0	.0
1	.1
2	.2
3	.3
4	.4
5	.5
6	.6
7	.7
8	.8
9	.9

④ represents production lot ID code

Example: For TC115331, the marking code is:

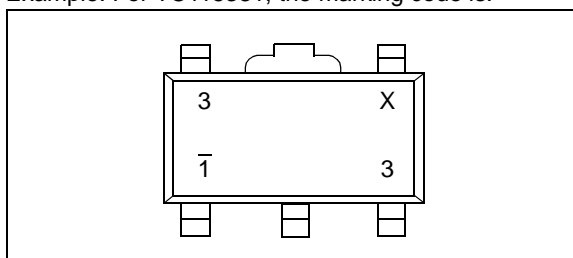

# TC115

## 5-Lead Plastic Small Outline Transistor Header (MT) (SOT-89)

**Note:** For the most current package drawings, please see the Microchip Packaging Specification located at <http://www.microchip.com/packaging>

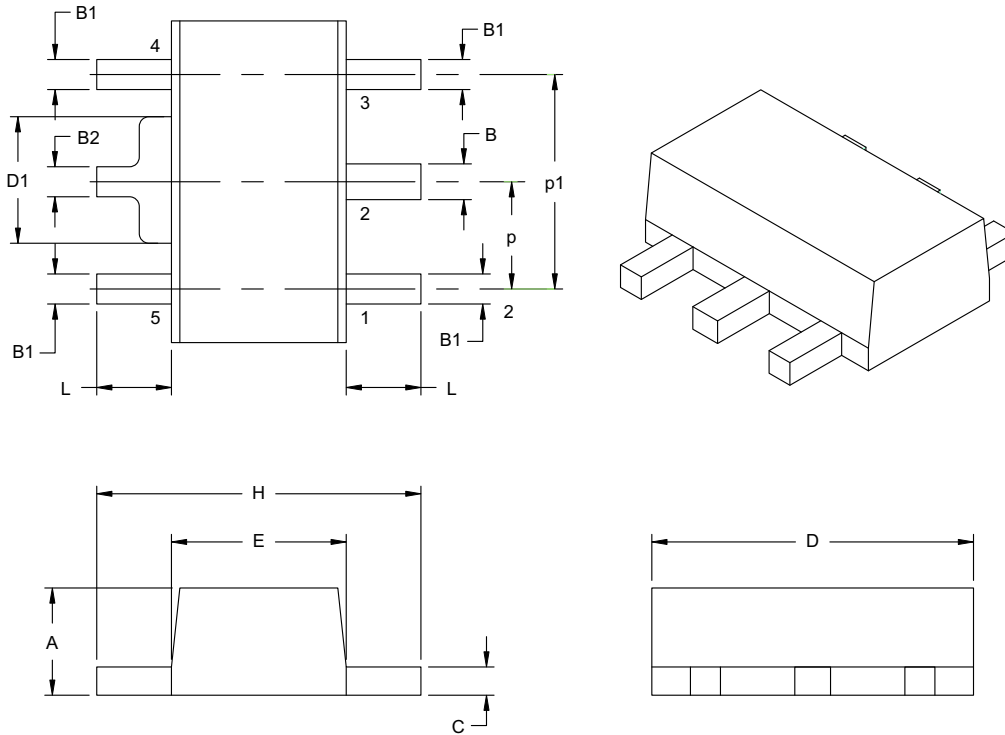

Dimension Limits	Units	INCHES		MILLIMETERS*	
		MIN	MAX	MIN	MAX
Pitch	p	.059 BSC		1.50 BSC	
Outside lead pitch (basic)	p1	.118 BSC		3.00 BSC	
Overall Height	A	.055	.063	1.40	1.60
Overall Width	H	-	.177	-	4.50
Molded Package Width	E	.090	.102	2.29	2.60
Overall Length	D	.173	.181	4.40	4.60
Tab Width	D1	.055	.071	1.40	1.80
Foot Length	L	.031	-	0.80	-
Lead Thickness	c	.015	.017	0.37	0.44
Lead 2 Width	B	.016	.021	0.41	0.53
Leads 1,3, 4 & 5 Width	B1	.014	.019	0.36	0.48
Tab Lead Width	B2	.013	.019	0.32	0.48

\*Controlling Parameter

Notes:

Dimensions D and E1 do not include mold flash or protrusions. Mold flash or protrusions shall not exceed .005" (0.127mm) per side.

Drawing No. C04-030

## PRODUCT IDENTIFICATION SYSTEM

To order or obtain information, e.g., on pricing or delivery, refer to the factory or the listed sales office.

<u>PART NO.</u>	<u>XX</u>	<u>X</u>	<u>X</u>	<u>XXX</u>
Device	Output Voltage	Oscillator Frequency	Temperature Range	Package
Device:	TC115:	PFM/PWM Step-Up DC/DC Converter		
Output Voltage:	30 = 3.0V			
	33 = 3.3V			
	50 = 5.0V			
Oscillator Frequency:	1 = 100 kHz			
Temperature Range:	E = -40°C to +85°C			
Package:	MTTR = 5L SOT-89, Tape and Reel			

**Examples:**

a) TC115301EMTTR: 3.0V Converter

b) TC115331EMTTR: 3.3V Converter

c) TC115501EMTTR: 5.0V Converter

## Sales and Support

### **Data Sheets**

Products supported by a preliminary Data Sheet may have an errata sheet describing minor operational differences and recommended workarounds. To determine if an errata sheet exists for a particular device, please contact one of the following:

1. Your local Microchip sales office
2. The Microchip Worldwide Site ([www.microchip.com](http://www.microchip.com))

Please specify which device, revision of silicon and Data Sheet (include Literature #) you are using.

### **Customer Notification System**

Register on our web site ([www.microchip.com/cn](http://www.microchip.com/cn)) to receive the most current information on our products.

# TC115

---

NOTES:

---

**Note the following details of the code protection feature on Microchip devices:**

- Microchip products meet the specification contained in their particular Microchip Data Sheet.
- Microchip believes that its family of products is one of the most secure families of its kind on the market today, when used in the intended manner and under normal conditions.
- There are dishonest and possibly illegal methods used to breach the code protection feature. All of these methods, to our knowledge, require using the Microchip products in a manner outside the operating specifications contained in Microchip's Data Sheets. Most likely, the person doing so is engaged in theft of intellectual property.
- Microchip is willing to work with the customer who is concerned about the integrity of their code.
- Neither Microchip nor any other semiconductor manufacturer can guarantee the security of their code. Code protection does not mean that we are guaranteeing the product as “unbreakable.”

Code protection is constantly evolving. We at Microchip are committed to continuously improving the code protection features of our products. Attempts to break Microchip's code protection feature may be a violation of the Digital Millennium Copyright Act. If such acts allow unauthorized access to your software or other copyrighted work, you may have a right to sue for relief under that Act.

---

Information contained in this publication regarding device applications and the like is provided only for your convenience and may be superseded by updates. It is your responsibility to ensure that your application meets with your specifications. MICROCHIP MAKES NO REPRESENTATIONS OR WARRANTIES OF ANY KIND WHETHER EXPRESS OR IMPLIED, WRITTEN OR ORAL, STATUTORY OR OTHERWISE, RELATED TO THE INFORMATION, INCLUDING BUT NOT LIMITED TO ITS CONDITION, QUALITY, PERFORMANCE, MERCHANTABILITY OR FITNESS FOR PURPOSE. Microchip disclaims all liability arising from this information and its use. Use of Microchip devices in life support and/or safety applications is entirely at the buyer's risk, and the buyer agrees to defend, indemnify and hold harmless Microchip from any and all damages, claims, suits, or expenses resulting from such use. No licenses are conveyed, implicitly or otherwise, under any Microchip intellectual property rights.

**Trademarks**

The Microchip name and logo, the Microchip logo, dsPIC, FlashFlex, KEELOQ, KEELOQ logo, MPLAB, PIC, PICmicro, PICSTART, PIC<sup>32</sup> logo, rPIC, SST, SST Logo, SuperFlash and UNI/O are registered trademarks of Microchip Technology Incorporated in the U.S.A. and other countries.

FilterLab, Hampshire, HI-TECH C, Linear Active Thermistor, MTP, SEEVAL and The Embedded Control Solutions Company are registered trademarks of Microchip Technology Incorporated in the U.S.A.

Silicon Storage Technology is a registered trademark of Microchip Technology Inc. in other countries.

Analog-for-the-Digital Age, Application Maestro, BodyCom, chipKIT, chipKIT logo, CodeGuard, dsPICDEM, dsPICDEM.net, dsPICworks, dsSPEAK, ECAN, ECONOMONITOR, FanSense, HI-TIDE, In-Circuit Serial Programming, ICSP, Mindi, MiWi, MPASM, MPF, MPLAB Certified logo, MPLIB, MPLINK, mTouch, Omniclient Code Generation, PICC, PICC-18, PICDEM, PICDEM.net, PICkit, PICtail, REAL ICE, rLAB, Select Mode, SQI, Serial Quad I/O, Total Endurance, TSHARC, UniWinDriver, WiperLock, ZENA and Z-Scale are trademarks of Microchip Technology Incorporated in the U.S.A. and other countries.

SQTP is a service mark of Microchip Technology Incorporated in the U.S.A.

GestIC and ULPP are registered trademarks of Microchip Technology Germany II GmbH & Co. & KG, a subsidiary of Microchip Technology Inc., in other countries.

All other trademarks mentioned herein are property of their respective companies.

© 2002-2012, Microchip Technology Incorporated, Printed in the U.S.A., All Rights Reserved.

 Printed on recycled paper.

ISBN: 9781620767474

**QUALITY MANAGEMENT SYSTEM**  
**CERTIFIED BY DNV**  
**== ISO/TS 16949 ==**

*Microchip received ISO/TS-16949:2009 certification for its worldwide headquarters, design and wafer fabrication facilities in Chandler and Tempe, Arizona; Gresham, Oregon and design centers in California and India. The Company's quality system processes and procedures are for its PIC<sup>®</sup> MCUs and dsPIC<sup>®</sup> DSCs, KEELOQ<sup>®</sup> code hopping devices, Serial EEPROMs, microperipherals, nonvolatile memory and analog products. In addition, Microchip's quality system for the design and manufacture of development systems is ISO 9001:2000 certified.*



# MICROCHIP

## Worldwide Sales and Service

### AMERICAS

**Corporate Office**  
2355 West Chandler Blvd.  
Chandler, AZ 85224-6199  
Tel: 480-792-7200  
Fax: 480-792-7277  
Technical Support:  
<http://www.microchip.com/support>  
Web Address:  
[www.microchip.com](http://www.microchip.com)

**Atlanta**  
Duluth, GA  
Tel: 678-957-9614  
Fax: 678-957-1455

**Boston**  
Westborough, MA  
Tel: 774-760-0087  
Fax: 774-760-0088

**Chicago**  
Itasca, IL  
Tel: 630-285-0071  
Fax: 630-285-0075

**Cleveland**  
Independence, OH  
Tel: 216-447-0464  
Fax: 216-447-0643

**Dallas**  
Addison, TX  
Tel: 972-818-7423  
Fax: 972-818-2924

**Detroit**  
Farmington Hills, MI  
Tel: 248-538-2250  
Fax: 248-538-2260

**Indianapolis**  
Noblesville, IN  
Tel: 317-773-8323  
Fax: 317-773-5453

**Los Angeles**  
Mission Viejo, CA  
Tel: 949-462-9523  
Fax: 949-462-9608

**Santa Clara**  
Santa Clara, CA  
Tel: 408-961-6444  
Fax: 408-961-6445

**Toronto**  
Mississauga, Ontario,  
Canada  
Tel: 905-673-0699  
Fax: 905-673-6509

### ASIA/PACIFIC

**Asia Pacific Office**  
Suites 3707-14, 37th Floor  
Tower 6, The Gateway  
Harbour City, Kowloon  
Hong Kong  
Tel: 852-2401-1200  
Fax: 852-2401-3431

**Australia - Sydney**  
Tel: 61-2-9868-6733  
Fax: 61-2-9868-6755

**China - Beijing**  
Tel: 86-10-8569-7000  
Fax: 86-10-8528-2104

**China - Chengdu**  
Tel: 86-28-8665-5511  
Fax: 86-28-8665-7889

**China - Chongqing**  
Tel: 86-23-8980-9588  
Fax: 86-23-8980-9500

**China - Hangzhou**  
Tel: 86-571-2819-3187  
Fax: 86-571-2819-3189

**China - Hong Kong SAR**  
Tel: 852-2401-1200  
Fax: 852-2401-3431

**China - Nanjing**  
Tel: 86-25-8473-2460  
Fax: 86-25-8473-2470

**China - Qingdao**  
Tel: 86-532-8502-7355  
Fax: 86-532-8502-7205

**China - Shanghai**  
Tel: 86-21-5407-5533  
Fax: 86-21-5407-5066

**China - Shenyang**  
Tel: 86-24-2334-2829  
Fax: 86-24-2334-2393

**China - Shenzhen**  
Tel: 86-755-8203-2660  
Fax: 86-755-8203-1760

**China - Wuhan**  
Tel: 86-27-5980-5300  
Fax: 86-27-5980-5118

**China - Xian**  
Tel: 86-29-8833-7252  
Fax: 86-29-8833-7256

**China - Xiamen**  
Tel: 86-592-2388138  
Fax: 86-592-2388130

**China - Zhuhai**  
Tel: 86-756-3210040  
Fax: 86-756-3210049

### ASIA/PACIFIC

**India - Bangalore**  
Tel: 91-80-3090-4444  
Fax: 91-80-3090-4123

**India - New Delhi**  
Tel: 91-11-4160-8631  
Fax: 91-11-4160-8632

**India - Pune**  
Tel: 91-20-2566-1512  
Fax: 91-20-2566-1513

**Japan - Osaka**  
Tel: 81-66-152-7160  
Fax: 81-66-152-9310

**Japan - Yokohama**  
Tel: 81-45-471-6166  
Fax: 81-45-471-6122

**Korea - Daegu**  
Tel: 82-53-744-4301  
Fax: 82-53-744-4302

**Korea - Seoul**  
Tel: 82-2-554-7200  
Fax: 82-2-558-5932 or  
82-2-558-5934

**Malaysia - Kuala Lumpur**  
Tel: 60-3-6201-9857  
Fax: 60-3-6201-9859

**Malaysia - Penang**  
Tel: 60-4-227-8870  
Fax: 60-4-227-4068

**Philippines - Manila**  
Tel: 63-2-634-9065  
Fax: 63-2-634-9069

**Singapore**  
Tel: 65-6334-8870  
Fax: 65-6334-8850

**Taiwan - Hsin Chu**  
Tel: 886-3-5778-366  
Fax: 886-3-5770-955

**Taiwan - Kaohsiung**  
Tel: 886-7-213-7828  
Fax: 886-7-330-9305

**Taiwan - Taipei**  
Tel: 886-2-2508-8600  
Fax: 886-2-2508-0102

**Thailand - Bangkok**  
Tel: 66-2-694-1351  
Fax: 66-2-694-1350

### EUROPE

**Austria - Wels**  
Tel: 43-7242-2244-39  
Fax: 43-7242-2244-393

**Denmark - Copenhagen**  
Tel: 45-4450-2828  
Fax: 45-4485-2829

**France - Paris**  
Tel: 33-1-69-53-63-20  
Fax: 33-1-69-30-90-79

**Germany - Munich**  
Tel: 49-89-627-144-0  
Fax: 49-89-627-144-44

**Italy - Milan**  
Tel: 39-0331-742611  
Fax: 39-0331-466781

**Netherlands - Drunen**  
Tel: 31-416-690399  
Fax: 31-416-690340

**Spain - Madrid**  
Tel: 34-91-708-08-90  
Fax: 34-91-708-08-91

**UK - Wokingham**  
Tel: 44-118-921-5869  
Fax: 44-118-921-5820

10/26/12

Компания «Океан Электроники» предлагает заключение долгосрочных отношений при поставках импортных электронных компонентов на взаимовыгодных условиях!

Наши преимущества:

- Поставка оригинальных импортных электронных компонентов напрямую с производств Америки, Европы и Азии, а так же с крупнейших складов мира;
- Широкая линейка поставок активных и пассивных импортных электронных компонентов (более 30 млн. наименований);
- Поставка сложных, дефицитных, либо снятых с производства позиций;
- Оперативные сроки поставки под заказ (от 5 рабочих дней);
- Экспресс доставка в любую точку России;
- Помощь Конструкторского Отдела и консультации квалифицированных инженеров;
- Техническая поддержка проекта, помощь в подборе аналогов, поставка прототипов;
- Поставка электронных компонентов под контролем ВП;
- Система менеджмента качества сертифицирована по Международному стандарту ISO 9001;
- При необходимости вся продукция военного и аэрокосмического назначения проходит испытания и сертификацию в лаборатории (по согласованию с заказчиком);
- Поставка специализированных компонентов военного и аэрокосмического уровня качества (Xilinx, Altera, Analog Devices, Intersil, Interpoint, Microsemi, Actel, Aeroflex, Peregrine, VPT, Syfer, Eurofarad, Texas Instruments, MS Kennedy, Miteq, Cobham, E2V, MA-COM, Hittite, Mini-Circuits, General Dynamics и др.);

Компания «Океан Электроники» является официальным дистрибьютором и эксклюзивным представителем в России одного из крупнейших производителей разъемов военного и аэрокосмического назначения «**JONHON**», а так же официальным дистрибьютором и эксклюзивным представителем в России производителя высокотехнологичных и надежных решений для передачи СВЧ сигналов «**FORSTAR**».



## JONHON

«**JONHON**» (основан в 1970 г.)

Разъемы специального, военного и аэрокосмического назначения:

(Применяются в военной, авиационной, аэрокосмической, морской, железнодорожной, горно- и нефтедобывающей отраслях промышленности)

«**FORSTAR**» (основан в 1998 г.)

ВЧ соединители, коаксиальные кабели,  
кабельные сборки и микроволновые компоненты:

(Применяются в телекоммуникациях гражданского и специального назначения, в средствах связи, РЛС, а так же военной, авиационной и аэрокосмической отраслях промышленности).



Телефон: 8 (812) 309-75-97 (многоканальный)

Факс: 8 (812) 320-03-32

Электронная почта: [ocean@oceanchips.ru](mailto:ocean@oceanchips.ru)

Web: <http://oceanchips.ru/>

Адрес: 198099, г. Санкт-Петербург, ул. Калинина, д. 2, корп. 4, лит. А