



High temperature Miniature Bayonet Lock
Connectors with rear insertable, rear release
crimp contacts. Connectors to EL 2112 Patt. 602
DEF STAN 59-56 & PAN 6432 -1 & -4.

Amphenol

AMPHENOL LIMITED

Amphenol 602 GB Series Connectors to EL 2112 Patt. 602 DEF STAN 59-56 & PAN 6432-1 & -4

The specifications herein are given only for the guidance of trade customers. The company's policy is one of continual development and improvement of its products and accordingly the company reserve the right at any time to alter such specifications without notice. No information contained herein is intended to constitute an offer of sale or reply and each prospective customer of any product should satisfy himself before purchase that the product is suitable for his requirements.



While the information in this catalogue is restricted to standard connectors in accordance with published military and national specifications, Amphenol have developed, and have under development, a number of 602 series products for special applications. If you cannot find a product in this catalogue to suit your requirements please do not hesitate to get in touch with the factory for the latest information on new product developments. 602GB connectors are high performance environmental circular connectors for the most demanding requirements of civil and military applications. Operating from -65°C to +200°C: resisting solvents and fluids likely to be encountered including heavy salt spray in ship-borne aircraft: and finally meeting the exhaustive climatic proving of BS 2G100 Part 2 Class 1.

They are directly compatible with connectors to MIL-C-26482 Series 2, which supersedes MIL-C-83723 Series 1.

Derating

When connectors to different specifications are intermated (e.g. Pattern 602 and MIL-C-26482 Series 11, the combination must not be operated under conditions more severe than the less stringent clause of either specification.

AMPHENOL LIMITED

Contents

Construction details	3	Flange mounting receptacle	12
Specification requirements	4	Dummy receptacle	12
Shell styles and polarisation availability	5	Single hole mounting receptacle	13
Insert orientations	6	Single hole mounting receptacles with solder/pintail contacts	13
Key, Keyway orientations	7	Caps and chains	14
Insert availability	8	Hermetic receptacles, single hole and solder mounting	15
Ordering details, Amphenol part numbers	9	Hermetic receptacle, flange mounting	16
Ordering details, Panavia part numbers	9	Cable Accessories	17 & 18
Ordering details, Pattern 602 numbers	10		
Plugs ribbed and standard coupling	11		
Flange mounting receptacle with solder/pintail contacts	11		

Other Circular Connector Series

62GB solder miniature bayonet lock connectors

A range of 62GB connectors are qualified to BS 9522 F001 7, DEF STAN 59-35 (Part 1) Sec. 3 Patt. 105 and MIL-C-26482E.

162GB crimp miniature bayonet lock connectors

162GB connectors are designed to qualify to BS 9522 N0001, the successor to DEF 5326-3 (prov.) Patt. 603. 1 62GB connectors are qualified to BS 9522 F0038.

Merlin I 118 Series high performance miniature bayonet lock connectors

The series features a rear insertable, rear release individual contact retention system with a single piece dielectric. The series are qualified to MIL-C-83723 Series 1 and MIL-C-26482 Series II. Operating temperature range is -55°C to +200°C.

Merlin II 418 Series high performance miniature bayonet lock connectors

High density miniature circular connectors sharing the polymeric ICR system of other Amphenol Merlin devices. Available in 50% and 100% no scoop versions to MIL-C-38999 and complying with European specifications LN 0029 729 and UTE C 93/422 Model HE306.

Merlin III 518 Series high performance miniature bayonet lock connectors

The series also benefits from a one piece all dielectric ICR system reducing connector parts from 122 to 12 in the 10-6 and 24-61 configurations. There is also a marked increase in contact dielectric separation. Qualified to MIL-C-26500 and MIL-C-83723 Series III.

EMI/RFI/EMP filter connectors 482 Series miniature bayonet lock connectors

Amphenol's EMI filtering connectors provide the efficiency of a built-in filter with the reliability of a high performance miniature connector and the advantages of crimp poke-home contacts. The connectors are electrically and environmentally comparable with connectors to DEF STAN 59-35 (Part. 1) Sec 3 Patt. 105, MIL-C-26482 and BS 9522 N0001 the successor to DEF 5326-3 (prov.) Patt, 603.

48 Series miniature screw coupling or bayonet lock connectors

48 Series connectors meet or exceed the requirements of MIL-C-26500 and MIL-C-38300. The connectors are sealed against extreme environments and utilise front release, rear insertable Poke Home Contacts.

348 Series high density connectors

Sub-miniature general purpose connectors to MIL-C-8151 1 utilising a single piece dielectric retention system. Basic constructions available are 50% and 100% scoop-proof.

97 Series standard screw coupling MS connectors

97 Series connectors are Amphenol's exclusive A and B construction to MIL-C-5015 and supersede the original AN range.

Hermetic seal connectors

Amphenol one piece glass to metal receptacles with pin contacts are available in a range of styles in Series 62GB 172, 179, 48, 348, 182 Series. Facilities available for customers' special designs.

Cables assemblies

Amphenol is fully equipped to undertake the preparation of all types of cable assemblies complying with the military vehicles and engineering establishments and fighting vehicles requirements of the Ministry of Defence - the Ministry of Environment (Motorways) for motorway control equipment - the Post Office Manufacturing code and to the British Standards Institute when applicable to Cable systems. Control procedures carried out in accordance with MIN DEF 05-21. Approval numbers BS 9000, 1043/M and CAA. DIA/5754/58. Moulded terminations form a specialised service by the company. The process offers such advantages as a waterproof seal between cable and connector back-end, mechanical protection, and a homogeneous joint between moulding and cable.

AMPHENOL LIMITED

Construction

Connector shells are machined from solid aluminium bar stock, not forged or extruded. Machining has inherent advantages in terms of strength and adaptability. 602GB connectors can be supplied in materials other than aluminium.

The normal shell finish used, which has a high resistance to corrosion, is cadmium plating with an olive drab chromate treatment. Other finishes may be supplied. For nonstandard materials or finishes consult factory for availability.

Hard dielectric insert components are glass filled epoxy, rubber components are silicone or fluorosilicone.

The connectors have gold plated contacts with crimp terminations. Pintail or solder bucket terminations are available in sealed (low profile) and Hermetic receptacles.

Sealed (Low Profile) receptacles have a maximum leakage of 1 cc/ per hour at 1 atmosphere.

Hermetic connectors with glass dielectric are manufactured with mild steel shells plated in tin over nickel and gold plated nickel alloy contacts. Passivated stainless steel shells also available.

Configurations for size 20 contacts range between 3 contacts in the size 8, 12.7mm (0.5in. diameter) shell up to a maximum of 61 contacts in the size 24, 36.1 mm (1.5in. diameter) shell.

Intermediate sizes and contact data for heavier current ratings are shown in the insert availability chart on page 8.

- | | |
|---|---|
| 1. Fluorosilicone fluid resistant sealing. | 5. Triple riser wire sealing. |
| 2. Closed entry hard front socket insert. | 6. 5 key shell polarisation. |
| 3. Triple track positive bayonet locking with visual mating indication. | 7. Peripheral shell seal. |
| 4. Interfacial mating seal. | 8. Precision formed metal clip retention system. |
| | 9. Cadmium finish shells with high resistance to corrosion and temperature. |

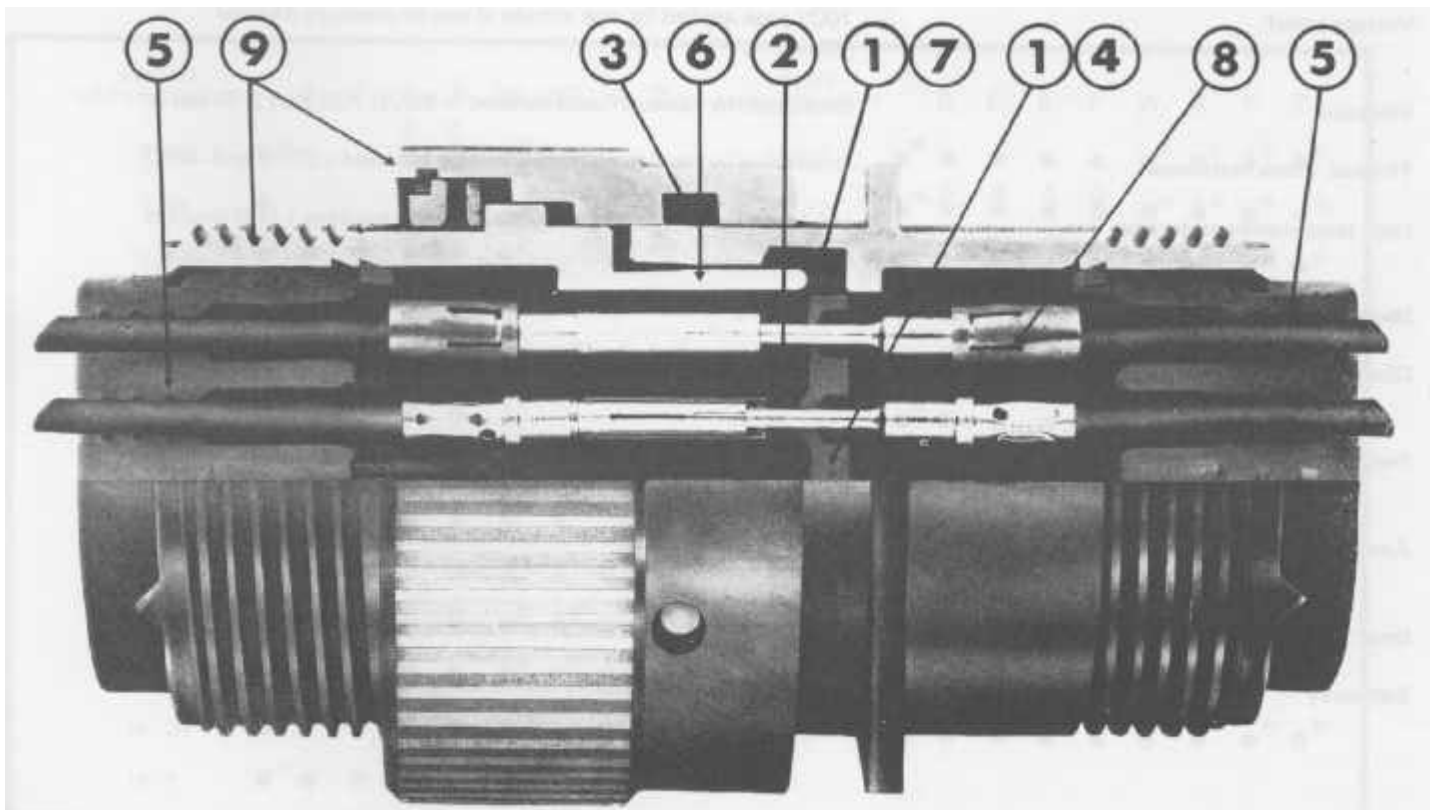

Design, development and manufacture of 602GB connectors have all been carried out in the United Kingdom by Amphenol Limited

AMPHENOL LIMITED

602GB Series EL2112 Patt.602 Specification Requirements

Engagement & disengagement forces	Torque measurements for mating and unmating range from 1.130 Nm (10 lb in) to 4.29 Nm (38 lb in).
Contact resistance	As per test in EL2112 and EL2113. Maximum 2.5m.Ω environmental styles, 5mΩ hermetic styles.
insulation resistance	Not less than 5000 megohms.
Shell continuity	Less than 5 millivolts for aluminium shells, less than 10 millivolts if one shell is ferrous. (At 1A).
Contact retention	Will withstand a load of 66.8 N (15 lbf) on a size 20 contact. 89.0 N (20 lbf) on a size 16 contact. With a movement of less than .015".
Sealing	At a pressure of 15 p.s.i. maximum leakage 1 c.c./hr. for fixed contact (low profile) environmental styles and 0.01 micron/cub.ft./hr. hermetic styles.
Fluid resistance	Meets requirements of EL2112 after immersion in aircraft fuels, turbine lubricants and hydraulic fluids.
Voltage proof	700V peak applied for one minute at low air pressure 44mbar (70,000 ft).
Vibration	Unaffected by vibration tests detailed in BS 2G 100, Part 2, Grade A.
Thermal shock resistance	Unaffected by rapid temperature cycling between +205°C and -65°C.
High temperature endurance	Insulation resistance better than 200 megohms after 1,000 hours at 200°C.
Mechanical endurance	500 matings and unmatings minimum.
Climatic	No voltage breakdown after the climatic test detailed in BS 2G 100 Part 2 for Class 1 equipment.
Fungus growth	Service unaffected by tests detailed in BS 2G 100 Part 2 for Class 1 connectors.
Acceleration	Performance unaffected after acceleration and crash landing test detailed in BS 2G 100 Part 2 for Class 1A equipment.
Insert retention	Insert secure against rotation and also axial loads of 334N (75 lbf).
Salt spray	Service unaffected by spray test detailed in EL2112.

AMPHENOL LIMITED

Table of Shell Styles

PLUG (Standard Coupling Ring) Page 11 PAN 6432-1 F & 4F  6026 - 06E	PLUG (Ribbed Coupling Ring) Page 11  6125 - 05 E	GROUNDED PLUG (Standard Coupling Ring) Page 11  - 06EG	FLANGE MOUNTING HERMETIC RECEPTACLE Page 16 PAN 6432-1 T  - 02H	SINGLE HOLE MOUNTING HERMETIC RECEPTACLE Page 15 PAN 6432-1 U  6027H - 07H	SOLDER MOUNTING HERMETIC RECEPTACLE Page 15 PAN 6432-1 E  6021H - 01H
FLANGE MOUNTING RECEPTACLE Page 12 PAN 6432-1B & 4B  6020 - 00E	SINGLE HOLE MOUNTING RECEPTACLE Page 13 PAN 6432 -1A & -4A  6027 07E	GROUNDED PLUG (Ribbed Coupling Ring) Page 11  - 05EG	DUMMY RECEPTACLE Page 12 PAN 6432-1 R  - 188	FLANGE MOUNTING RECEPTACLE Page 11 -02A (219)  - 02A	SINGLE HOLE MOUNTING RECEPTACLE Page 13 -5002 (219)  - 5002

Hermetic receptacles are available with pin tail terminations by adding deviation (345) to the Amphenol Part Number.

Polarisation Availability

INSERT ARRANGEMENT	B	C	E	F	W	X	Y	Z	INSERT ARRANGEMENT	B	C	E	F	W	X	Y	Z	
8-33	●*		△	△	●*				18-11	●*	●	●	●	●	●*	●*	●*	●*
8-98	●		●	●					18-32	●*	△	△	△	△	●*	●*	●*	●*
10-6	●*	△	△	△	●*				20-16	●*	●	●	●	●*	●*	●*	●*	
12-3	●*	●	●	●			●*		20-39	●	●	●	●	●	●	●	●	
12-10	●*	△	△	△	●*	●*	●*	●*	20-41	●*	●	●	●	●*	●*	●*		
14-4	●*	△	△	△	†*				22-12	●*	●	●	●					
14-5	●*	●	●	●	●*	●*	●*	●*	22-21	●*	●	●	●	●*	●*	●*	●*	
14-12	●*	●	●	●	●*	●*			22-41	●*	●	●	●	●*	†	†		
14-15	●	●	●	●	●	●	●	●	22-55	●*	●	●	●	●*	●*	●*	●*	
14-19	●*	△	△	△	●*	●*	●*		24-19	●*	△	△	△	●*	●*	●*		
16-8	●*	●	●	●	●*	●*	●*	●*	24-31	●*	●	●	●	●*	●*	●		
16-26	●*	●	●	●	●*	●*	●*		24-61	●*	●	●	●	●*	●*	●*	●*	
18-8	●*	●	●	●														

For orientations not shown above consult factory

† These polarisations are not included in EL2112 Pattern 602 but are available as Amphenol proprietary part numbers.

- * Inserts and orientations in PAN 6432-1.
- △ Inserts and orientations in PAN 6432-4.

AMPHENOL LIMITED

Insert Orientations



Normal position
with pin contacts



Alternative position of insert
with socket contacts
(\emptyset counter clockwise)



Alternate position of insert
with pin contacts
(\emptyset clockwise)

Each diagram shows mating face of insert

Insert arrangement	Normal	Orientation \emptyset (degrees)			
		W	X	Y	Z
8-33	0	90	-	-	-
8-98	0	-	-	-	-
10-6	0	90	-	-	-
12-3	0	-	-	180	-
12-10	0	60	155	270	295
14-4	0	45	-	-	-
14-5	0	40	92	184	273
14-12	0	43	90	-	-
14-15	0	17	110	155	234
14-19	0	30	165	315	-
16-8	0	54	152	180	331
16-26	0	60	-	275	338
18-8	0	-	-	-	-
18-11	0	62	119	241	340
18-32	0	85	138	222	265
20-16	0	238	318	333	347
20-39	0	63	144	252	333
20-41	0	45	126	225	-
22-12	0	-	-	-	-
22-21	0	16	135	175	349
22-41	0	39	135	264	-
22-55	0	30	142	226	314
24-19	0	30	165	315	-
24-31	0	90	225	255	-
24-61	0	90	180	270	324

AMPHENOL LIMITED

Key/Keyway Orientations



Datum is always taken from major key or keyway. In receptacles the major keyway always remains fixed in relation to the mounting flange. For the B,C,E and F orientations, the three bayonet locations and associated minor keyways are rotated complete, in accordance with the table below.



















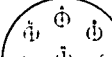
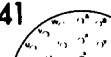
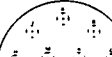

N.B. - The accompanying diagram shows a receptacle shell, with keyways. Corresponding key orientations for a mating plug shell are therefore always clockwise.

Shell Size	VALUES FOR α (degrees)					VALUES FOR θ (degrees)					VALUES FOR β (degrees)				
	N	B	C	E	F	N	B	C	E	F	N	B	C	E	F
8	105	-	-	118	82	35	-	-	30	50	75	-	-	100	75
10	105	85	125	115	85	35	35	35	30	50	75	75	75	100	75
12	105	89	121	115	85	35	35	35	30	50	75	75	75	100	75
14	105	91	119	75	120	35	35	35	30	50	75	75	75	100	75
16	105	93	117	75	120	35	35	35	30	50	75	75	75	100	75
18	105	95	115	75	120	35	35	35	30	50	75	75	75	100	75
20	105	95	115	75	120	35	35	35	30	50	75	75	75	100	75
22	105	97	113	75	120	35	35	35	30	50	75	75	75	100	75
24	105	97	113	75	120	35	35	35	30	50	75	75	75	100	75

Shell Size	VALUES FOR ϕ (degrees)					VALUES FOR ω (degrees)				
	ORIENTATION					ORIENTATION				
	N	B	C	E	F	N	B	C	E	F
8	50	-	-	30	45	60	-	-	73	47
10	50	50	50	30	45	60	40	80	70	50
12	50	50	50	30	45	60	44	76	70	50
14	50	50	50	30	35	60	46	74	30	75
16	50	50	50	30	35	60	48	72	30	75
18	50	50	50	30	35	60	50	70	30	75
20	50	50	50	30	35	60	50	70	30	75
22	50	50	50	30	35	60	52	68	30	75
24	50	50	50	30	35	60	52	68	30	75

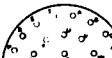
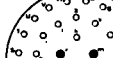
AMPHENOL LIMITED

Inset Availability

8		10		12		14		16		
8-33  Δ H	10-6  Δ H	12-10  Δ H	14-4  Δ	14-12  Δ	16-26  Δ H					
8-98  H			14-15  H	14-19  Δ H						
† Lettering of insets shown here corresponds to views of front (mating) surface of pin inserts or rear face (cable accessory end) of socket inserts. H styles available in hermetic versions. Δ styles available with fixed contacts. Key O No. 20 size contacts ● No. 16 size contacts ○ No. 12 size contacts		12-3  Δ H	14-5  Δ H	16-8  Δ H						
18		20		22		24				
18-8  Δ H	20-41  Δ H	22-12  H	22-41  Δ	24-31  Δ H	18-32  Δ H	20-39  Δ H	22-55  Δ H	24-61  Δ H		
18-11  H	20-16  Δ	22-21  Δ	24-19  Δ							

RATING 1 ALTITUDE	VOLTAGE RATING 1	
	RECOMMENDED WORKING VOLTAGE	TEST VOLTAGE
	a.c.	a.c.
	r.m.s.	r.m.s.
Sea Level	600	1,500
15,000 metres	375	500
21,000 metres	300	375
33,000 metres	175	200

RATING 2 ALTITUDE	VOLTAGE RATING 2	
	RECOMMENDED WORKING VOLTAGE	TEST VOLTAGE
	a.c.	a.c.
	r.m.s.	r.m.s.
Sea Level	1,000	2,300
15,000 metres	600	750
21,000 metres	450	550
33,000 metres	175	200

CURRENT RATING

The performance of 602 Series connectors at all times exceeds the maximum continuous bunched rating, of the appropriate temperature rating and size of wire or cable. This bunched rating is therefore the determining factor. In the case of mixed loadings, the greatest individual load shall be the bunched loading. In any combination of ambient temperature plus temperature rise due to current flow through the contacts the maximum temperature of 200°C shall not be exceeded.

† Contact characters are shown for identification purposes only. Every effort is made to ensure accuracy but actual connectors should be inspected to ensure actual position of characters. If in doubt consult nearest sales office.

Contact loading should not exceed:-

Size 20 Contacts 7.5A

Size 16 Contacts 15A

Size 12 Contacts 25A

AMPHENOL LIMITED

Ordering by Amphenol Part Numbers

All connectors containing size 12 contacts must have a Strain Relief Accessory fitted to maintain the stated environmental performances. To ensure the best performance of the wire sealing grommet it is recommended that this type of accessory should be fitted to all connectors. See page 17 for part numbers.



Ordering by Panavia Part Numbers



NOTE: Whether you order by the 602 Series, Panavia or the Pattern 602 number, all qualified connectors are supplied marked with Pattern 602 part numbers. (See page 10).

AMPHENOL LIMITED

Ordering by Pattern 602 Numbers

All connectors containing size 12 contacts must have a Strain Relief Accessory fitted to maintain the stated environmental performances. To ensure the best performance of the wire sealing grommet it is recommended that this type of accessory should be fitted to all connectors. See page 17 for part numbers.



Connectors ordered against Patt. 602 numbers (as above) will be supplied in compliance with EL 2112 Patt. 602 requirements, this is a basic connector with the exact complement of contacts which comply with EL2113. This is identical to AMPHENOL Condition 8.

Amphenol Conditions and Deviations

Where connectors to Pattern 602 or 602GB number systems are required 'to be supplied' with accessories, or to other special requirements, the appropriate Amphenol Condition for Pattern 602 or Deviation for 602GB, as shown below, should always be quoted. e.g. 6020-18-32 PN Amphenol Cond 2 or 602GB-OOE 18-32P (309).

Amphenol Condition 1

Plugs and Sockets supplied against this condition will be supplied without cable accessories but complete with contacts (including spares), and filler plugs.

Amphenol Condition 2 (Deviation 309)

Plugs and Sockets supplied against this condition will be supplied as Amphenol Condition 1 plus a cable accessory without strain relief to MS3416.

Amphenol Condition 3 (Deviation 310)

Plugs and Sockets supplied against this condition will be supplied as Amphenol Condition 1 plus a straight backshell cable accessory with Cable Tie strain relief to MS 31528.

Amphenol Condition 4 (Deviation 311)

Plugs and Sockets supplied against this condition will be supplied as Amphenol Condition 1 plus a 90° cable accessory with Cable Tie to MS3154

Amphenol Condition 5 (Deviation 326)

Plugs and Sockets supplied against this condition will be supplied Amphenol Condition 1 but with adaptor for heat shrink boot to MS 3158.

Amphenol Condition 6 (Deviation 335)

Plugs and Sockets supplied against this condition will be supplied as Amphenol Condition 1 plus a straight cable accessory with saddle clamp to MS 3417

Amphenol Condition 7 (Deviation 336)

Plugs and Sockets supplied against this condition will be supplied as Amphenol Condition 1 plus a 90° cable accessory with saddle clamp to MS 3418.

Amphenol Condition 8 (Deviation 341)

Plugs and Sockets supplied against basic 6020, 6026, 6027 reference numbers will be supplied with the exact complement of contacts but without seal plugs, tools and accessories.

Amphenol Condition 9 (Deviation 301)

Plugs and Sockets supplied against this condition will be without contacts, seal plugs, tools and accessories.

Deviation (219) Receptacles only, film wire terminations.

Deviation (345) Hermetic receptacles only, pintail terminations.

Ribbed Coupling Ring Plug - 05E 6125 (To RRE | P | 50753) Grounded Plug 05EG

Shell Size	C1 Max. Dia.	C2 max. Dia.	G ± 0.76 (± .030)	H max.	L Thd UNEF 2A
8	19.86 (0.782)	22.66 (0.892)	4.06 (0.160)	31.24 (1.230)	½ - 20
10	23.52 (0.926)	25.83 (1.017)	4.06 (0.160)	31.24 (1.230)	5/8 - 24
12	26.49 (1.043)	29.01 (1.142)	4.06 (0.160)	31.24 (1.230)	¾ - 20
14	30.05 (1.183)	32.18 (1.267)	4.06 (0.160)	31.24 (1.230)	7/8 - 20
16	33.15 (1.305)	36.93 (1.454)	4.06 (0.160)	31.24 (1.230)	1 - 20
18	35.33 (1.391)	39.70 (1.563)	4.06 (0.160)	31.24 (1.230)	1 1/16 - 18
20	38.89 (1.531)	42.85 (1.687)	4.06 (0.160)	31.24 (1.230)	1 3/16 - 18
22	42.06 (1.656)	45.64 (1.797)	4.06 (0.160)	31.24 (1.230)	1 5/16 - 18
24	45.14 (1.777)	48.82 (1.922)	4.06 (0.160)	31.24 (1.230)	1 7/16 - 18



Standard Plug -06E 6026 PAN 6432 - 1F PAN 6432 - 4F Grounded Plug 06EG



Flange Mtg. Receptacle

- 02A Sealed (Low Profile) with Solder bucket terminations
- 02A (219) Sealed (Low Profile) with pintail terminations.

Shell Size	B Max.	C Sq max	D dia. ± 0.05 (± 0.002)	E Max.	G1 Max.	G2 Max.	M Dia. Max.	N Dia. Max.	P Max	X sq. ± 0.13 (± .005)
08	11.71 (0.461)	21.03 (0.828)	3.18 (0.125)	1.96 (0.077)	12.22 (0.481)	10.62 (0.418)	12.04 (0.474)	12.42 (0.489)	2.21 (0.087)	15.09 (0.594)
10	11.71 (0.461)	24.23 (0.954)	3.18 (0.125)	1.96 (0.077)	12.22 (0.481)	10.62 (0.418)	15.01 (0.591)	15.60 (0.614)	2.21 (0.087)	18.26 (0.719)
12	11.71 (0.461)	25.59 (1.047)	3.18 (0.125)	1.96 (0.077)	12.22 (0.481)	10.62 (0.418)	19.08 (0.751)	18.77 (0.739)	2.21 (0.087)	20.82 (0.812)
14	11.71 (0.461)	28.98 (1.141)	3.18 (0.125)	1.96 (0.077)	12.22 (0.481)	10.62 (0.418)	22.25 (0.876)	21.95 (0.864)	2.21 (0.087)	23.01 (0.906)
16	11.71 (0.461)	31.34 (1.234)	3.18 (0.125)	1.96 (0.077)	12.22 (0.481)	10.62 (0.418)	25.43 (1.001)	25.12 (0.989)	2.21 (0.087)	24.61 (0.969)
18	11.71 (0.461)	33.73 (1.328)	3.18 (0.125)	1.96 (0.077)	12.22 (0.481)	10.62 (0.418)	28.60 (1.126)	26.67 (1.050)	2.21 (0.087)	28.97 (1.062)
20	14.38 (0.566)	36.91 (1.453)	3.18 (0.125)	2.08 (0.082)	9.60 (0.378)	9.58 (0.377)	31.78 (1.251)	29.85 (1.175)	5.38 (0.212)	29.36 (1.156)
22	14.38 (0.566)	40.08 (1.578)	3.18 (0.125)	2.08 (0.082)	9.60 (0.378)	9.58 (0.377)	34.95 (1.376)	33.02 (1.300)	5.38 (0.212)	31.75 (1.250)
24	15.11 (0.595)	43.26 (1.703)	3.86 (0.152)	2.08 (0.082)	10.31 (0.406)	8.71 (0.343)	38.13 (1.501)	36.20 (1.425)	5.38 (0.212)	34.92 (1.375)



NOTE:- For panel piercing dimensions see type -00E (page 12).

Dimensions: mm - bold type; inches - light type in brackets throughout unless otherwise stated
* for other Pintail lengths consult factory.

AMPHENOL LIMITED

Flange Mtg. Receptacle -

00E
6020
PAN 6432-1B
PAN 6432-4B

Dummy
Receptacle - 188
PAN 6432-IR



Ordering Details 602GB-188-XX or PAN 6432-1 R-XX replace XX by shell size required e.g. 602GB-188-18 or PAN 6432-1R-18.

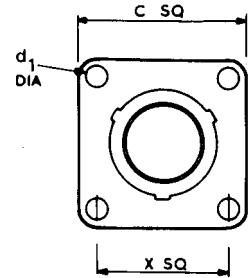
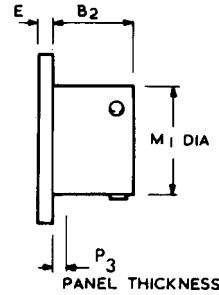

Shell Size	B1 ± 0.38 (± .015)	B2 ± 0.25 (± .010)	C Sq max.	D1 dia. ± 0.05 (± .002)	D2 dia. + 0.13 (+ .005)	E ± 0.41 (± .016)	F max.	G ± 0.76 (± .030)	L Thd UNEF 2A
8	11.33 (0.446)	12.12 (0.477)	21.03 (0.828)	3.18 (0.125)	3.25 (0.128)	1.57 (0.062)	30.86 (1.215)	4.06 (0.160)	½ -20
10	11.33 (0.446)	12.12 (0.477)	24.23 (0.954)	3.18 (0.125)	3.25 (0.128)	1.57 (0.062)	30.86 (1.215)	4.06 (0.160)	5/8 - 24
12	11.33 (0.446)	12.12 (0.477)	26.59 (1.047)	3.18 (0.125)	3.25 (0.128)	1.57 (0.062)	30.86 (1.215)	4.06 (0.160)	¾ - 20
14	11.33 (0.446)	12.12 (0.477)	28.98 (1.141)	3.18 (0.125)	3.25 (0.128)	1.57 (0.062)	30.86 (1.215)	4.06 (0.160)	7/8 - 20
16	11.33 (0.446)	12.12 (0.477)	31.34 (1.234)	3.18 (0.125)	3.25 (0.128)	1.57 (0.062)	30.86 (1.215)	4.06 (0.160)	1 - 20
18	11.33 (0.446)	12.12 (0.477)	33.73 (1.328)	3.18 (0.125)	3.25 (0.128)	1.57 (0.062)	30.86 (1.215)	4.06 (0.160)	1 1/16 - 18
20	14.50 (0.571)	14.50 (0.571)	36.91 (1.453)	3.18 (0.125)	3.25 (0.128)	2.39 (0.094)	32.38 (1.275)	4.06 (0.160)	1 3/16 - 18
22	14.50 (0.571)	14.50 (0.571)	40.08 (1.578)	3.18 (0.125)	3.25 (0.128)	2.39 (0.094)	32.38 (1.275)	4.06 (0.160)	1 5/16 - 18
24	15.37 (0.605)	15.37 (0.605)	43.26 (1.703)	3.86 (0.152)	3.94 (0.155)	2.39 (0.094)	32.38 (1.275)	4.06 (0.160)	1 7/16 - 18

Shell Size	M1 Dia. Max.	M2 Dia. max.	Panel Thickness			V min.	W dia. ± 0.13 (± .005)	X sq ± 0.13 (± .005)
			P1 max.	P2 max.	P3 max.			
8	12.04 (0.474)	12.67 (0.499)	3.18 (0.125)	2.21 (0.087)	3.18 (0.125)	23.62 (0.930)	14.43 (0.568)	15.09 (0.594)
10	15.01 (0.591)	15.88 (0.625)	3.18 (0.125)	2.21 (0.087)	3.18 (0.125)	26.80 (1.055)	17.40 (0.685)	18.26 (0.719)
12	19.08 (0.751)	19.05 (0.750)	3.18 (0.125)	2.21 (0.087)	3.18 (0.125)	29.98 (1.180)	21.95 (0.864)	20.62 (0.812)
14	22.25 (0.876)	22.22 (0.875)	3.18 (0.125)	2.21 (0.087)	3.18 (0.125)	33.15 (1.305)	25.12 (0.989)	23.01 (0.906)
16	25.43 (1.001)	25.40 (1.000)	3.18 (0.125)	2.21 (0.087)	3.18 (0.125)	37.85 (1.490)	28.27 (1.113)	24.61 (0.969)
18	28.60 (1.126)	26.97 (1.062)	3.18 (0.125)	2.21 (0.087)	3.18 (0.125)	40.64 (1.600)	31.45 (1.238)	26.97 (1.062)
20	31.78 (1.251)	30.15 (1.187)	3.18 (0.125)	5.38 (0.212)	5.38 (0.212)	43.81 (1.725)	34.62 (1.363)	29.36 (1.156)
22	34.95 (1.376)	33.32 (1.312)	3.18 (0.125)	5.38 (0.212)	5.38 (0.212)	46.61 (1.835)	37.80 (1.488)	31.75 (1.250)
24	38.13 (1.501)	36.50 (1.437)	3.18 (0.125)	5.38 (0.212)	5.38 (0.212)	49.78 (1.960)	41.02 (1.615)	34.92 (1.375)

PANEL PIERCING



AMPHENOL LIMITED

Single Hole Mtg .Receptacle

-07E
6027

PAN 6432-1A
PAN 6432-4A



Shell Size	B max.	D Sq.	E max.	F max.	G ± 0.76 (± .030)	K A/F max.	L Thd UNEF 2A	M Max. dia.	P Panel thickness		V min.	W dia. ± 0.13 (± .005)	Z ₁ ±0.13 (± .005)	Z ₂ ±0.13 (± .005)
									max.	min.				
8	17.96 (0.707)	24.23 (0.954)	2.87 (0.113)	30.86 (1.215)	4.06 (0.160)	19.48 (0.767)	½ - 20	12.04 (0.474)	4.75 (0.187)	1.57 (0.062)	25.15 (0.990)	14.53 (0.572)	13.34 (0.525)	13.61 (0.536)
10	17.96 (0.707)	27.38 (1.078)	2.87 (0.113)	30.86 (1.215)	4.06 (0.160)	22.66 (0.892)	5/8 - 24	15.01 (0.591)	4.75 (0.187)	1.57 (0.062)	28.32 (1.115)	17.70 (0.697)	16.51 (0.650)	16.79 (0.661)
12	17.96 (0.707)	32.16 (1.266)	2.87 (0.113)	30.86 (1.215)	4.06 (0.160)	27.41 (1.079)	¾ - 20	19.08 (0.751)	4.75 (0.187)	1.57 (0.062)	33.15 (1.305)	22.73 (0.895)	20.65 (0.813)	20.93 (0.824)
14	17.96 (0.707)	35.33 (1.391)	2.87 (0.113)	30.86 (1.215)	4.06 (0.160)	30.61 (1.205)	7/8 - 20	22.25 (0.876)	4.75 (0.187)	1.57 (0.062)	36.32 (1.430)	25.65 (1.010)	23.80 (0.937)	24.08 (0.948)
16	17.96 (0.707)	38.51 (1.516)	2.87 (0.113)	30.88 (1.215)	4.06 (0.160)	33.76 (1.329)	1 - 20	25.43 (1.001)	4.75 (0.187)	1.57 (0.062)	39.88 (1.570)	28.83 (1.135)	26.95 (1.061)	27.23 (1.072)
18	17.96 (0.707)	41.88 (1.641)	2.87 (0.113)	30.86 (1.215)	4.06 (0.160)	36.96 (1.455)	1 1/16 - 18	28.60 (1.126)	4.75 (0.187)	1.57 (0.062)	43.69 (1.720)	32.00 (1.260)	30.12 (1.186)	30.40 (1.197)
20	19.61 (0.772)	48.43 (1.828)	3.76 (0.148)	32.38 (1.275)	4.06 (0.160)	40.11 (1.579)	1 3/16 - 18	31.78 (1.251)	6.35 (0.250)	1.57 (0.062)	47.37 (1.865)	33.18 (1.385)	33.30 (1.311)	33.58 (1.322)
22	19.61 (0.772)	49.63 (1.954)	3.76 (0.148)	32.38 (1.275)	4.06 (0.160)	43.31 (1.705)	1 5/16 - 18	34.95 (1.376)	6.35 (0.250)	1.57 (0.062)	50.93 (2.005)	38.35 (1.510)	36.47 (1.436)	36.75 (1.447)
24	19.61 (0.772)	52.78 (2.078)	3.78 (0.148)	32.38 (1.275)	4.06 (0.160)	46.48 (1.829)	1 7/16 - 18	38.13 (1.501)	5.56 (0.219)	1.57 (0.062)	54.61 (2.150)	41.53 (1.635)	39.65 (1.561)	39.93 (1.572)

Single Hole Mtg .Receptacle

-002 Sealed (Low Profile) with Solder Bucket Terminations *

-5002 (219) Sealed (Low Profile) with Pintail Terminations *

Shell Size	B Max.	C Dia. Max.	D Max.	G Max.	M Max dia.	P Panel thickness		± 0.13 (± .005)
						Max.	min.	
8	17.70 (0.697)	23.27 (0.916)	22.15 (0.872)	7.47 (0.294)	12.04 (0.474)	4.75 (0.187)	1.57 (0.062)	13.34 (0.525)
10	17.70 (0.697)	26.44 (1.041)	25.81 (1.016)	7.47 (0.294)	15.01 (0.591)	4.75 (0.187)	1.57 (0.062)	16.51 (0.650)
12	17.70 (0.697)	31.19 (1.228)	31.29 (1.232)	7.47 (0.294)	19.08 (0.751)	4.75 (0.187)	1.57 (0.062)	20.66 (0.813)
14	17.70 (0.697)	34.37 (1.353)	34.98 (1.377)	7.47 (0.294)	22.25 (0.876)	4.75 (0.187)	1.57 (0.062)	23.80 (0.937)
16	17.70 (0.697)	37.54 (1.478)	38.63 (1.521)	7.47 (0.294)	25.43 (1.001)	4.75 (0.187)	1.57 (0.062)	26.95 (1.061)
18	17.70 (0.697)	40.72 (1.603)	42.32 (1.666)	7.47 (0.294)	28.60 (1.126)	4.75 (0.187)	1.57 (0.062)	30.12 (1.186)
20	19.25 (0.758)	45.49 (1.791)	46.97 (1.810)	8.20 (0.323)	31.78 (1.251)	6.36 (0.250)	1.57 (0.062)	33.30 (1.311)
22	19.25 (0.758)	48.67 (1.916)	49.63 (0.954)	8.20 (0.323)	34.95 (1.376)	6.36 (0.250)	1.57 (0.062)	36.47 (1.436)
24	19.25 (0.758)	51.84 (2.041)	53.31 (2.099)	8.20 (0.323)	38.13 (1.501)	5.58 (0.219)	1.57 (0.062)	39.65 (1.561)

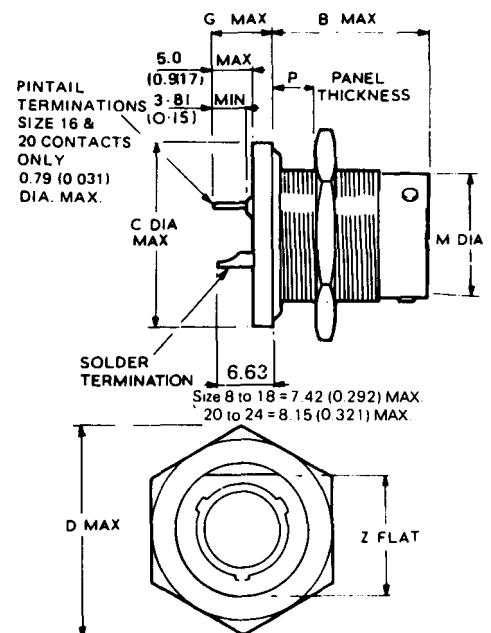

NOTE:- For panel piercing dimensions see style -07E.

*Order by part numbers 602GB-5002-XX-XXXX or 602GB-5002-XX-XXXX (219). Replace XX-XXXX by insert arrangement, contact style and orientation require.

*For other Pintail lengths consult factory.

AMPHENOL LIMITED

Caps & Chains

62GB Series caps and chains are common to 602GB and 62GB Series

STANDARD TYPE



To fit
 Single hole fixing receptacles
 Flange mounting receptacles

Amphenol Part No. Panavia No.
 62GB-736-08 to 24 PAN 6432-1 MA-08 to 24
 62GB-738-08 to 24 PAN 6432-1 MB-08 to 24



To fit
 Plugs

Amphenol Part No. Panavia No.
 602GB-149-08-24 PAN 6432-1 MF-08 to 24
 not suitable for use with 62GB series.

RIBBED TYPE



To fit
 Single hole fixing receptacles

Amphenol Part No.
 62GB-997-08 to 24



To fit
 Plugs

Amphenol Part No.
 6026 B-134-08 to 24

NOTE: For caps and cords refer to our 62GB catalogue
 (max temperature 125° C)

Shell Size	A1 max.	A2 max.	C1 Dia. max.	C2 Dia. max.	C3 Dia. Max.	d1 +0.5 -0.13 (+.010) (-.005)	d2 +0.25 (+.010)	F approx.
8	16.76 (0.660)	16.64 (0.655)	18.26 (0.719)	18.64 (0.734)	22.65 (0.892)	3.18 (0.125)	14.68 (0.578)	76.00 (3.000)
10	16.76 (0.660)	16.64 (0.655)	21.44 (0.844)	21.82 (0.859)	25.83 (1.017)	3.18 (0.125)	17.86 (0.703)	76.00 (3.000)
12	16.76 (0.660)	16.64 (0.655)	25.40 (1.000)	25.40 (1.000)	29.00 (1.142)	3.18 (0.125)	22.63 (0.891)	89.00 (3.500)
14	16.76 (0.660)	16.64 (0.655)	28.57 (1.125)	28.57 (1.125)	32.18 (1.267)	3.18 (0.125)	25.81 (1.016)	89.00 (3.500)
16	16.76 (0.660)	16.64 (0.655)	31.75 (1.250)	31.75 (1.250)	36.93 (1.454)	3.18 (0.125)	28.98 (1.141)	89.00 (3.500)
18	16.76 (0.660)	16.64 (0.655)	34.92 (1.375)	34.92 (1.375)	39.70 (1.563)	3.18 (0.125)	32.16 (1.266)	89.00 (3.500)
20	18.29 (0.720)	16.64 (0.655)	38.10 (1.500)	38.10 (1.500)	42.84 (1.687)	3.18 (0.125)	35.33 (1.391)	102.00 (4.000)
22	18.29 (0.720)	16.64 (0.655)	41.27 (1.625)	41.27 (0.625)	45.64 (1.797)	3.18 (0.125)	38.50 (1.516)	102.00 (4.000)
24	19.18 (0.755)	17.53 (0.690)	44.45 (1.750)	44.45 (1.750)	48.81 (1.922)	3.73 (0.147)	41.68 (1.641)	102.00 (4.000)

AMPHENOL LIMITED

Single Hole Mtg. Hermetic Seal Receptacle

-07H
6027H
PAN 6432 -1U

Shell Size	A max	B max	D sq. max	G max.		K A/F max.	L Thd UNEF 2A
				contact Size 20	contact Size 16		
8	20.83 (0.820)	17.96 (0.707)	24.23 (0.954)	3.40 (0.134)	5.18 (0.204)	19.48 (0.767)	9/16 - 24
10	20.83 (0.820)	17.96 (0.707)	27.38 (1.078)	3.40 (0.134)	5.18 (0.204)	22.66 (0.892)	11/16 - 24
12	20.83 (0.820)	17.96 (0.707)	32.16 (1.266)	3.40 (0.134)	5.18 (0.204)	27.41 (1.079)	7/8 - 20
14	20.83 (0.820)	17.96 (0.707)	35.33 (1.391)	3.40 (0.134)	5.18 (0.204)	30.61 (1.205)	1 - 20
16	20.83 (0.820)	17.96 (0.707)	38.51 (1.516)	3.40 (0.134)	5.18 (0.204)	33.76 (1.329)	1 1/8 - 18
18	20.83 (0.820)	17.96 (0.707)	41.68 (1.641)	3.40 (0.134)	5.18 (0.204)	36.96 (1.455)	1 1/4 - 18
20	23.37 (0.920)	19.61 (0.772)	46.43 (1.828)	2.51 (0.099)	4.29 (0.169)	40.11 (1.579)	1 3/8 - 18
22	23.37 (0.920)	19.61 (0.772)	49.63 (1.954)	2.51 (0.099)	4.29 (0.169)	43.31 (1.705)	1 1/2 - 18
24	24.16 (0.951)	20.40 (0.803)	52.78 (2.078)	2.51 (0.099)	4.29 (0.169)	46.46 (1.829)	1 5/8 - 18
Shell Size	M Dia. max.	P Panel thickness		V min.	W ±0.13 (±0.005)	Z ±0.13 (±0.005)	Z1 ±0.13 (±0.005)
8	12.04 (0.474)	4.75 (0.187)	1.57 (0.062)	25.15 (0.990)	14.53 (0.572)	13.34 (0.525)	13.61 (0.536)
10	15.01 (0.591)	4.75 (0.187)	1.57 (0.062)	28.32 (1.115)	17.70 (0.697)	16.51 (0.650)	16.79 (0.661)
12	19.08 (0.751)	4.75 (0.187)	1.57 (0.062)	33.15 (1.305)	22.73 (0.895)	20.65 (0.813)	20.93 (0.824)
14	22.25 (0.876)	4.75 (0.187)	1.57 (0.062)	36.32 (1.430)	25.65 (1.010)	23.80 (0.937)	24.08 (0.948)
16	25.43 (1.001)	4.75 (0.187)	1.57 (0.062)	39.88 (1.570)	28.83 (1.135)	26.95 (1.061)	27.23 (1.072)
18	28.60 (1.126)	4.75 (0.187)	1.57 (0.062)	43.69 (1.720)	32.00 (1.260)	30.12 (1.186)	30.40 (1.197)
20	31.78 (1.251)	6.35 (0.250)	1.57 (0.062)	47.37 (1.865)	35.18 (1.385)	33.30 (1.311)	33.58 (1.322)
22	34.95 (1.376)	6.35 (0.250)	1.57 (0.062)	50.93 (2.005)	38.35 (1.510)	36.47 (1.436)	36.75 (1.447)
24	38.13 (1.501)	6.35 (0.250)	1.57 (0.062)	54.61 (2.150)	41.53 (1.635)	39.65 (1.561)	39.93 (1.572)

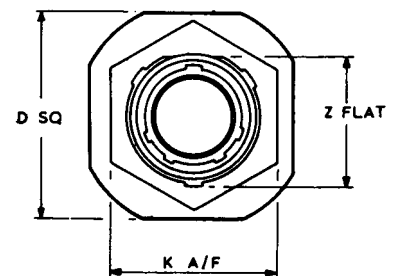

Solder Mtg. Hermetic Seal Receptacle

- 01H
6021 H
PAN 6432-1E

Shell Size	A max.	C max. Dia.	G max.		H max.	M max. Dia.	N max. Dia.	V min.	W Dia. ±0.13 (±0.005)
			contact Size 20	contact Size 16					
8	20.35 (0.801)	16.13 (0.635)	4.52 (0.178)	6.30 (0.248)	3.96 (0.156)	12.04 (0.474)	14.30 (0.563)	23.62 (0.930)	14.48 (0.570)
10	20.35 (0.801)	19.30 (0.760)	4.52 (0.178)	6.30 (0.248)	3.96 (0.156)	15.01 (0.591)	17.09 (0.673)	26.80 (1.055)	17.27 (0.680)
12	20.35 (0.801)	21.69 (0.854)	4.52 (0.178)	6.30 (0.248)	3.96 (0.156)	19.08 (0.751)	19.86 (0.782)	29.98 (1.180)	20.04 (0.789)
14	20.35 (0.801)	24.87 (0.979)	4.52 (0.178)	8.30 (0.248)	3.96 (0.156)	22.25 (0.876)	23.04 (0.907)	33.15 (1.305)	23.22 (0.914)
16	20.35 (0.801)	28.04 (1.104)	4.52 (0.178)	6.30 (0.248)	3.96 (0.156)	25.43 (1.001)	26.21 (1.032)	37.85 (1.490)	26.39 (1.039)
18	20.35 (0.801)	31.19 (1.228)	4.52 (0.178)	6.30 (0.248)	3.96 (0.156)	28.60 (1.126)	29.39 (1.157)	40.64 (1.600)	29.57 (1.164)
20	21.92 (0.863)	33.58 (1.322)	4.52 (0.178)	6.30 (0.248)	3.96 (0.156)	31.78 (1.251)	31.78 (1.251)	43.81 (1.725)	31.95 (1.258)
22	22.73 (0.895)	36.78 (1.448)	3.71 (0.146)	5.49 (0.216)	4.79 (0.188)	34.95 (1.376)	34.95 (1.376)	46.61 (1.835)	35.13 (1.383)
24	22.73 (0.895)	39.98 (1.574)	3.71 (0.146)	5.49 (0.216)	4.78 (0.188)	38.13 (1.501)	38.13 (1.501)	49.78 (1.960)	38.30 (1.508)

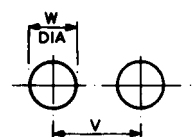

For pin tail termination contacts in hermetic connectors add deviation (345) to the Amphenol Part Number.

AMPHENOL LIMITED

Flange Mtg. Hermetic Seal Receptacle - 02H PAN 6432 - 1T

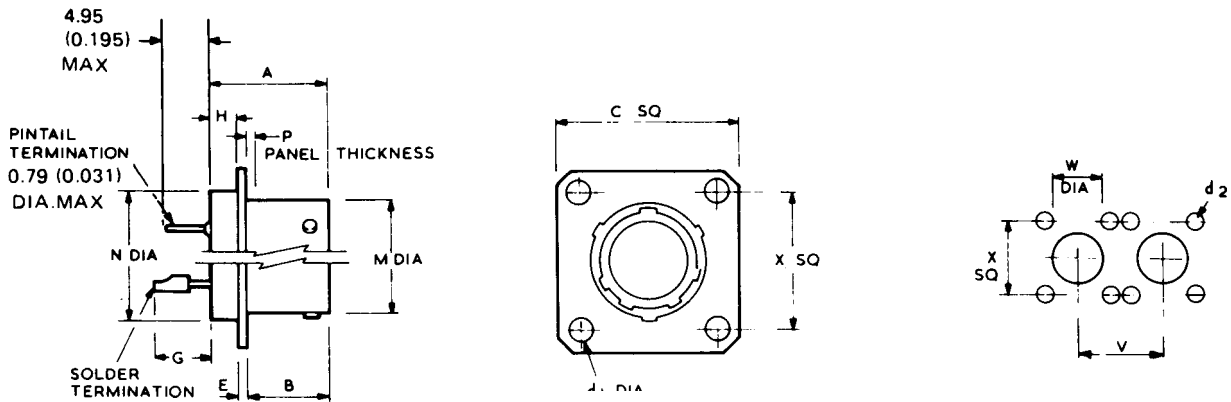

Shell Size	A max.	B ±0.25 (±.010)	C Sq. max.	d ₁ Dia. ±0.05 (±.002)	d ₂ ±0.13 (±.005)	E ±0.41 (±.016)	G max. contact Size 20	G max. contact Size 16
8	20.35 (0.801)	14.94 (0.588)	21.03 (0.828)	3.05 (0.120)	3.25 (0.128)	1.57 (0.062)	4.52 (0.178)	6.30 (0.248)
10	20.35 (0.801)	14.94 (0.588)	24.23 (0.954)	3.05 (0.120)	3.25 (0.128)	1.57 (0.062)	4.52 (0.178)	6.30 (0.248)
12	20.35 (0.801)	14.94 (0.588)	26.59 (1.047)	3.05 (1.120)	3.25 (0.128)	1.57 (0.062)	4.52 (0.178)	6.30 (0.248)
14	20.35 (0.801)	14.94 (0.588)	28.98 (1.141)	3.05 (0.120)	3.25 (0.128)	1.57 (0.062)	4.52 (0.178)	6.30 (0.248)
16	20.35 (0.801)	14.94 (0.588)	31.34 (1.234)	3.05 (0.120)	3.25 (0.128)	1.57 (0.062)	4.52 (0.178)	6.30 (0.248)
18	20.35 (0.801)	14.94 (0.588)	33.73 (1.328)	3.05 (0.120)	3.25 (0.128)	1.57 (0.062)	4.57 (0.178)	6.30 (0.248)
20	21.92 (0.863)	16.51 (0.650)	36.91 (1.453)	3.05 (0.120)	3.25 (0.128)	2.39 (0.094)	4.52 (0.178)	6.30 (0.248)
27	27.73 (0.895)	16.51 (0.650)	40.08 (1.578)	3.05 (0.120)	3.25 (0.128)	2.39 (0.094)	3.71 (0.146)	5.49 (0.216)
24	22.73 (0.805)	16.51 (0.650)	13.26 (1.703)	3.73 (0.147)	3.94 (0.155)	2.39 (0.094)	3.71 (0.146)	5.49 (0.216)

Shell Size	H max.	M Dia. max.	N Dia. max.	P max. Panel Thickness	V min	W dia. +0.13 (+.005)	X sq. +0.13 (+.005)
8	3.18 (0.125)	12.04 (0.474)	14.30 (0.563)	2.21 (0.087)	23.62 (0.930)	14.43 (0.568)	15.09 (0.594)
10	3.18 (0.125)	15.01 (0.591)	17.09 (0.673)	2.21 (0.087)	26.80 (1.055)	17.40 (0.685)	18.26 (0.719)
17	3.18 (0.125)	19.08 (0.751)	19.86 (0.782)	2.21 (0.087)	29.98 (1.180)	21.95 (0.864)	20.62 (0.812)
14	3.18 (0.125)	22.25 (0.876)	23.04 (0.907)	2.21 (0.087)	33.15 (1.305)	25.12 (0.989)	23.01 (0.906)
16	3.18 (0.125)	25.43 (1.001)	26.21 (1.032)	2.21 (0.087)	37.85 (1.490)	28.27 (1.113)	24.61 (0.969)
18	3.18 (0.125)	28.60 (1.126)	29.39 (1.157)	2.21 (0.087)	40.64 (1.600)	31.45 (1.238)	26.97 (1.062)
20	2.36 (0.093)	31.78 (1.251)	31.78 (1.251)	5.38 (0.212)	43.81 (1.725)	34.62 (1.363)	29.36 (1.156)
22	3.18 (0.125)	34.95 (1.376)	34.95 (1.376)	5.38 (0.212)	46.61 (1.835)	37.80 (1.488)	31.75 (1.250)
24	3.18 (0.125)	38.13 (1.501)	38.13 (1.501)	5.38 (0.212)	49.78 (1.960)	41.07 (1.615)	34.92 (1.375)

For pin tail termination contacts in hermetic connectors add deviation (345) to the Amphenol Part Number.

AMPHENOL LIMITED

Cable Accessories

To ensure the best performance of the connector wire sealing grommet it is recommended that a Strain Relief Accessory should be fitted. See ordering information on pages 9 & 10.



With Straight Strain Relief Saddle Clamp.
For ordering as a separate item 602GB-198-XX replace XX by shell size required e.g. 602GB-198-18.

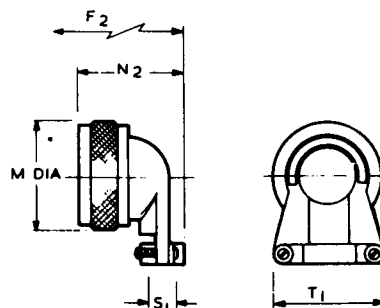

With 90° Strain Relief Saddle Clamp.
For ordering as a separate item 602GB-199-XX replace XX by shell size required e.g. 602GB-199-18



With Straight Strain Relief Clamp.
For ordering as a separate item 602GB-129-XX or PAN 6432-1 D-XX replace XX by shell size required e.g. 602GB-129-08 or PAN 6432-1 D-08.



With 90° Strain Relief Clamp.
For ordering as a separate item 602GB-133-XX or PAN 6432-1 K-XX replace XX by shell size required e.g. 602GB-133-08 or PAN 6432-1 K-OE.



Spacer pad for Cable tie type strain relief clamps 602GB-141



Grommet nut assembly for heat shrink boot 602GB-140-XX replace XX by shell size required e.g. 602GB-140-08.



Grommet nut Without Strain Relief
For ordering as a separate item 602GB-127-XX or PAN 6432-1 C-XX replace XX by shell size required. e.g. 602GB-127-08 or PAN 6432-1 C-08.

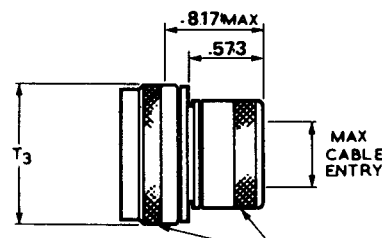

RFI Adaptor for heat shrink boot 602GB-285-XX for use with 06EG and 05EG plugs. Note: As part no. depends on cable being used please consult factory for details.

Note: For cable accessory dimensions see tables on following page.

AMPHENOL LIMITED

Cable Accessories

RESILIENT BUSH

These bushes are for use with saddle clamp type strain relief clamps but are not included with these accessories and if required must be ordered separately.

602GB-205-XX or PAN 6432-1 H-XX replace XX by shell size required.

e.g. 602GB-205-18 or PAN 6432 -1 H-18.



Shell Size	F ₁ max. when fitted to		F ₂ max. when fitted to		F ₃ max. when fitted to		F ₄ max. when fitted to		F ₅ max. when fitted to		F ₆ max. when fitted to		M dia max.
	Plug	Recept.	Plug	Recept.	Plug	Recept.	Plug	Recept.	Plug	Recept.	Plug	Recept.	
8	48.67 (1.916)	48.29 (1.901)	52.45 (2.065)	52.07 (2.050)	43.56 (1.715)	43.18 (1.700)	54.79 (2.157)	54.33 (2.139)	38.28 (1.507)	37.90 (1.492)	53.24 (2.092)	52.76 (2.077)	15.67 (0.617)
10	51.46 (2.026)	51.08 (2.011)	54.53 (2.147)	54.15 (2.132)	43.56 (1.175)	43.18 (1.700)	54.79 (2.157)	54.33 (2.139)	38.28 (1.507)	37.90 (1.492)	53.24 (2.092)	52.76 (2.077)	18.64 (0.734)
12	54.64 (2.151)	54.25 (2.136)	59.44 (2.340)	59.05 (2.325)	43.56 (1.175)	43.18 (1.700)	56.31 (2.217)	55.85 (2.199)	38.28 (1.507)	37.90 (1.492)	54.24 (2.092)	52.76 (2.077)	21.79 (0.858)
14	54.64 (2.151)	54.25 (2.136)	60.96 (2.400)	60.58 (2.385)	43.56 (1.175)	43.18 (1.700)	60.63 (2.387)	60.17 (2.369)	38.28 (1.507)	37.90 (1.492)	54.24 (2.092)	52.76 (2.077)	24.99 (0.984)
16	57.81 (2.270)	57.43 (2.261)	64.74 (2.549)	64.36 (2.534)	43.56 (1.175)	43.18 (1.700)	60.63 (2.387)	60.17 (2.369)	38.28 (1.507)	37.90 (1.492)	54.24 (2.092)	52.76 (2.077)	28.24 (1.112)
18	64.16 (2.526)	63.78 (2.511)	67.59 (2.661)	67.21 (2.646)	44.20 (1.740)	43.18 (1.700)	62.66 (2.467)	62.20 (2.449)	38.28 (1.507)	37.90 (1.492)	54.24 (2.092)	52.76 (2.077)	30.94 (1.218)
20	67.34 (2.651)	68.48 (2.696)	70.76 (2.786)	71.91 (2.831)	44.20 (1.740)	45.34 (1.785)	65.96 (2.597)	67.03 (2.639)	38.28 (1.507)	39.42 (1.552)	54.24 (2.092)	52.76 (2.077)	34.16 (1.345)
22	70.51 (2.776)	71.65 (2.821)	73.94 (2.911)	75.08 (2.956)	44.20 (1.740)	45.34 (1.785)	69.01 (2.717)	70.08 (2.759)	38.28 (1.071)	39.42 (1.552)	54.24 (2.092)	52.76 (2.077)	37.29 (1.468)
24	73.69 (2.901)	74.83 (2.946)	77.11 (3.036)	78.26 (3.081)	44.20 (1.740)	45.34 (1.785)	72.31 (2.847)	73.38 (2.889)	38.28 (1.507)	39.42 (1.552)	54.24 (2.092)	52.76 (2.077)	40.46 (1.593)

Shell Size	N ₁ max.	N ₂ max.	N ₃ max.	N ₄ max.	N ₅ max.	N ₆ Max.	S ₁ Cable Entry		S ₂ dia. max.	T ₁ max.	T ₂ dia. max.	T ₃ dia. max.	U max.
							Open	Closed					
8	24.18 (0.952)	27.97 (1.101)	19.08 (0.751)	30.23 (1.190)	13.72 (0.540)	28.58 (1.125)	5.18 (0.204)	3.18 (0.125)	6.60 (0.260)	19.10 (0.752)	16.69 (0.657)	15.67 (0.617)	30.99 (1.220)
10	26.97 (1.062)	30.05 (1.183)	19.08 (0.751)	30.23 (1.190)	13.72 (0.540)	28.58 (1.125)	7.26 (0.286)	4.75 (0.187)	9.27 (0.365)	21.13 (0.832)	19.86 (0.782)	18.64 (0.734)	30.99 (1.220)
12	30.15 (1.187)	34.95 (1.376)	19.08 (0.751)	31.75 (1.250)	13.72 (0.540)	28.58 (1.125)	10.57 (0.416)	7.39 (0.291)	12.73 (0.501)	25.10 (0.988)	23.80 (0.937)	21.79 (0.858)	41.15 (1.620)
14	30.15 (1.187)	36.47 (1.436)	19.08 (0.751)	36.07 (1.420)	13.72 (0.540)	28.58 (1.125)	12.09 (0.476)	8.92 (0.351)	14.60 (0.575)	26.57 (1.046)	26.67 (1.050)	24.99 (0.984)	42.16 (1.660)
16	33.32 (1.312)	40.26 (1.585)	19.08 (0.751)	36.07 (1.420)	13.72 (0.540)	28.58 (1.125)	15.88 (0.625)	12.73 (0.501)	17.78 (0.700)	33.50 (1.319)	31.47 (1.239)	28.24 (1.112)	43.69 (1.720)
18	39.67 (1.562)	43.10 (1.697)	19.71 (0.776)	38.10 (1.500)	13.72 (0.540)	28.58 (1.125)	17.93 (0.706)	13.16 (0.518)	19.79 (0.779)	36.86 (1.451)	35.00 (1.378)	30.94 (1.218)	43.69 (1.720)
20	42.85 (1.687)	46.28 (1.822)	19.71 (0.776)	41.40 (1.630)	13.72 (0.540)	28.58 (1.125)	21.11 (0.831)	14.76 (0.581)	22.96 (0.904)	39.55 (1.557)	38.10 (1.500)	34.16 (1.345)	45.47 (1.790)
22	46.02 (1.812)	49.45 (1.947)	19.71 (0.776)	44.45 (1.750)	13.72 (0.540)	28.58 (1.125)	24.28 (0.956)	16.36 (0.644)	26.14 (1.029)	41.99 (1.653)	41.43 (1.631)	37.29 (1.468)	46.99 (1.850)
24	49.20 (1.937)	52.83 (2.072)	19.71 (0.776)	47.75 (1.880)	13.72 (0.540)	28.58 (1.125)	27.46 (1.081)	17.93 (0.706)	29.06 (1.144)	45.08 (1.775)	44.45 (1.750)	40.46 (1.593)	48.51 (1.910)

Компания «Океан Электроники» предлагает заключение долгосрочных отношений при поставках импортных электронных компонентов на взаимовыгодных условиях!

Наши преимущества:

- Поставка оригинальных импортных электронных компонентов напрямую с производств Америки, Европы и Азии, а так же с крупнейших складов мира;
- Широкая линейка поставок активных и пассивных импортных электронных компонентов (более 30 млн. наименований);
- Поставка сложных, дефицитных, либо снятых с производства позиций;
- Оперативные сроки поставки под заказ (от 5 рабочих дней);
- Экспресс доставка в любую точку России;
- Помощь Конструкторского Отдела и консультации квалифицированных инженеров;
- Техническая поддержка проекта, помощь в подборе аналогов, поставка прототипов;
- Поставка электронных компонентов под контролем ВП;
- Система менеджмента качества сертифицирована по Международному стандарту ISO 9001;
- При необходимости вся продукция военного и аэрокосмического назначения проходит испытания и сертификацию в лаборатории (по согласованию с заказчиком);
- Поставка специализированных компонентов военного и аэрокосмического уровня качества (Xilinx, Altera, Analog Devices, Intersil, Interpoint, Microsemi, Actel, Aeroflex, Peregrine, VPT, Syfer, Eurofarad, Texas Instruments, MS Kennedy, Miteq, Cobham, E2V, MA-COM, Hittite, Mini-Circuits, General Dynamics и др.);

Компания «Океан Электроники» является официальным дистрибьютором и эксклюзивным представителем в России одного из крупнейших производителей разъемов военного и аэрокосмического назначения «JONHON», а так же официальным дистрибьютором и эксклюзивным представителем в России производителя высокотехнологичных и надежных решений для передачи СВЧ сигналов «FORSTAR».



JONHON

«JONHON» (основан в 1970 г.)

Разъемы специального, военного и аэрокосмического назначения:

(Применяются в военной, авиационной, аэрокосмической, морской, железнодорожной, горно- и нефтедобывающей отраслях промышленности)

«FORSTAR» (основан в 1998 г.)

ВЧ соединители, коаксиальные кабели,
кабельные сборки и микроволновые компоненты:

(Применяются в телекоммуникациях гражданского и специального назначения, в средствах связи, РЛС, а так же военной, авиационной и аэрокосмической отраслях промышленности).



Телефон: 8 (812) 309-75-97 (многоканальный)

Факс: 8 (812) 320-03-32

Электронная почта: ocean@oceanchips.ru

Web: <http://oceanchips.ru/>

Адрес: 198099, г. Санкт-Петербург, ул. Калинина, д. 2, корп. 4, лит. А