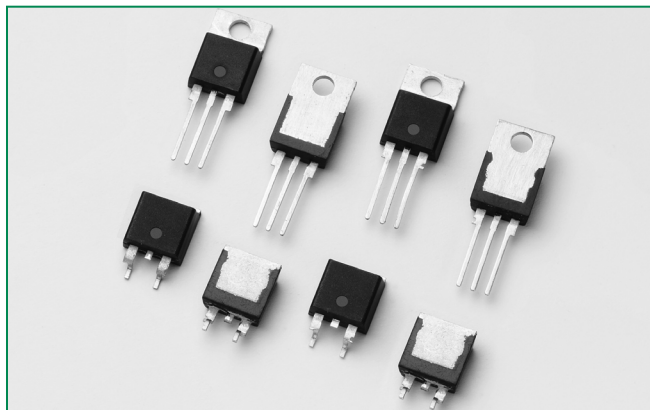


**RoHS Sxx15x & Sxx16x Series**



**Description**

Excellent unidirectional switches for phase control applications such as heating and motor speed controls. Standard phase control SCRs are triggered with few milliamperes of current at less than 1.5V potential.

**Features & Benefits**

- RoHS compliant
- Glass – passivated junctions
- Voltage capability up to 1000 V
- Surge capability up to 225 A

**Applications**

Typical applications are capacitive discharge systems for strobe lights, nailers, staplers and gas engine ignition. Also controls for power tools, home/brown goods and white goods appliances.

Internally constructed isolated packages are offered for ease of heat sinking with highest isolation voltage.

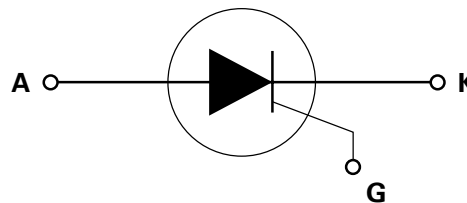
**Agency Approval**

Agency	Agency File Number
	L Package: E71639

**Main Features**

Symbol	Value	Unit
$I_{T(RMS)}$	15 & 16	A
$V_{DRM}/V_{RRM}$	400 to 1000	V
$I_{GT}$	30	mA

**Schematic Symbol**



**Absolute Maximum Ratings – Standard SCRs**

Symbol	Parameter	Test Conditions		Value	Unit
		Model	Temperature		
$I_{T(RMS)}$	RMS on-state current	Sxx15L	$T_c = 90^\circ\text{C}$	15	A
		Sxx16R Sxx16N	$T_c = 110^\circ\text{C}$	16	
$I_{T(AV)}$	Average on-state current	Sxx15L	$T_c = 90^\circ\text{C}$	9.5	A
		Sxx16R Sxx16N	$T_c = 110^\circ\text{C}$	10.0	
$I_{TSM}$	Peak non-repetitive surge current	single half cycle; $f = 50\text{Hz}$ ; $T_J$ (initial) = $25^\circ\text{C}$		188	A
		single half cycle; $f = 60\text{Hz}$ ; $T_J$ (initial) = $25^\circ\text{C}$		225	
$I^2t$	$I^2t$ Value for fusing	$t_p = 8.3 \text{ ms}$		210	$\text{A}^2\text{s}$
$di/dt$	Critical rate of rise of on-state current	$f = 60 \text{ Hz}; T_J = 125^\circ\text{C}$		125	$\text{A}/\mu\text{s}$
$I_{GM}$	Peak gate current	$T_J = 125^\circ\text{C}$		3	A
$P_{G(AV)}$	Average gate power dissipation	$T_J = 125^\circ\text{C}$		0.6	W
$T_{stg}$	Storage temperature range			-40 to 150	$^\circ\text{C}$
$T_J$	Operating junction temperature range			-40 to 125	$^\circ\text{C}$

Note: xx = voltage

**Electrical Characteristics (T<sub>J</sub> = 25°C, unless otherwise specified)**

Symbol	Test Conditions	Value		Unit	
		Sxx15x	Sxx16x		
I <sub>GT</sub>	V <sub>D</sub> = 12V; R <sub>L</sub> = 60 Ω		MAX.	30	mA
			MIN.	1	
V <sub>GT</sub>			MAX.	1.5	V
dv/dt	V <sub>D</sub> = V <sub>DRM</sub> ; gate open; T <sub>J</sub> = 100°C	400V	MIN.	450	V/μs
		600V		425	
		800V		400	
	1000V	200			
	V <sub>D</sub> = V <sub>DRM</sub> ; gate open; T <sub>J</sub> = 125°C	400V		350	
		600V		325	
800V		300			
V <sub>GD</sub>	V <sub>D</sub> = V <sub>DRM</sub> R <sub>L</sub> = 3.3 kΩ T <sub>J</sub> = 110°C		MIN.	0.2	V
I <sub>H</sub>	I <sub>T</sub> = 200mA (initial)		MAX.	40	mA
t <sub>q</sub>	I <sub>T</sub> =2A; t <sub>p</sub> =50μs; dv/dt=5V/μs; di/dt=-30A/μs		MAX.	35	μs
t <sub>gt</sub>	I <sub>G</sub> = 2 × I <sub>GT</sub> PW = 15μs I <sub>T</sub> = 12A		TYP.	2	μs

Note: xx = voltage, x = package

(1) I<sub>T</sub>=2A; t<sub>p</sub>=50μs; dv/dt=5V/μs; di/dt=-30A/μs

**Static Characteristics**

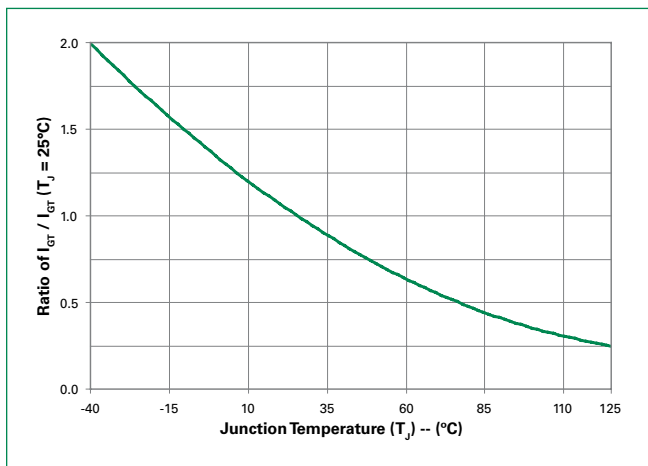
Symbol	Test Conditions		Value	Unit		
V <sub>TM</sub>	15A Device I <sub>T</sub> = 30A; t <sub>p</sub> = 380 μs		MAX.	1.6	V	
	16A Device I <sub>T</sub> = 32A; t <sub>p</sub> = 380 μs					
I <sub>DRM</sub> / I <sub>RRM</sub>	V <sub>DRM</sub> = V <sub>RRM</sub>	T <sub>J</sub> = 25°C	400 - 600V	MAX.	10	μA
			800 - 1000V		20	
		T <sub>J</sub> = 100°C	400 - 600V		500	
			800V		1000	
			1000V		3000	
		T <sub>J</sub> = 125°C	400 - 600V		1000	
			800V		2000	

**Thermal Resistances**

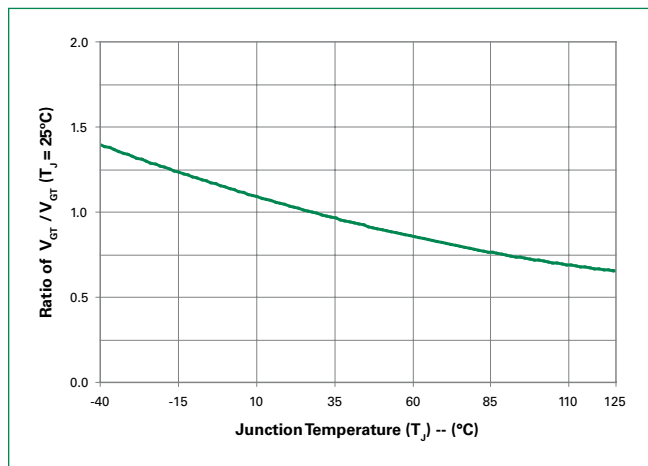
Symbol	Parameter	Value	Unit	
R <sub>θ(J-C)</sub>	Junction to case (AC)	Sxx16R/ Sxx16N	1.1	°C/W
		Sxx15L	2.5	
R <sub>θ(J-A)</sub>	Junction to ambient	Sxx16R	40	°C/W
		Sxx15L	50	

Note: xx = voltage

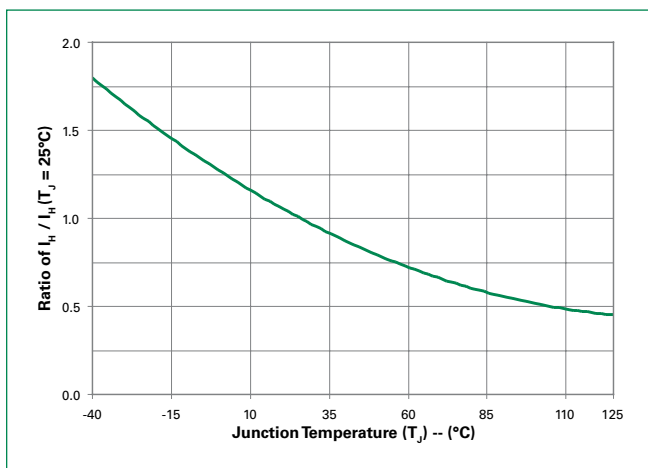
**Figure 1: Normalized DC Gate Trigger Current vs. Junction Temperature**



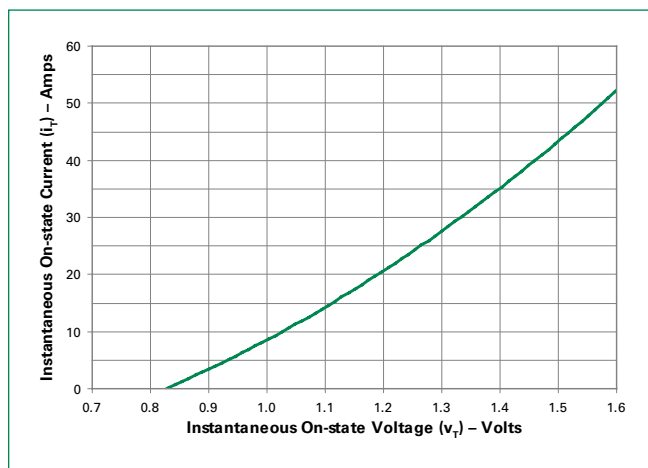
**Figure 2: Normalized DC Gate Trigger Voltage vs. Junction Temperature**



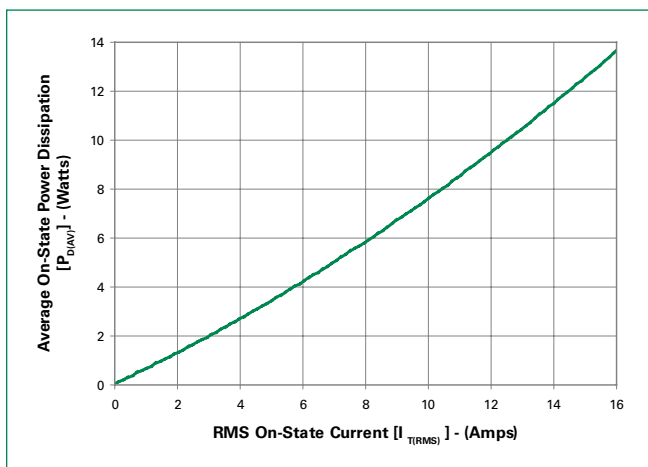
**Figure 3: Normalized DC Holding Current vs. Junction Temperature**



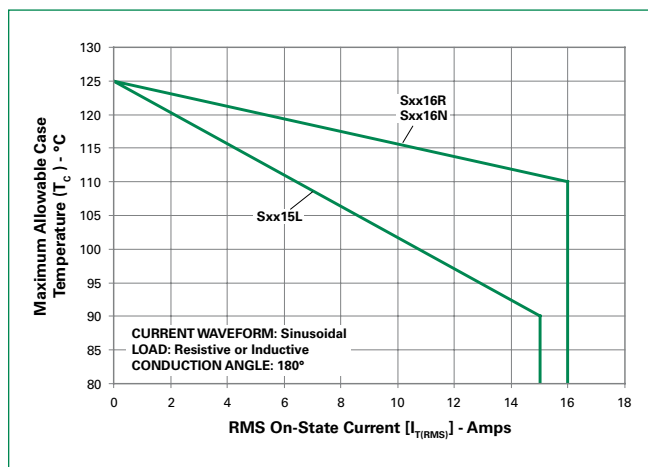
**Figure 4: On-State Current vs. On-State Voltage (Typical)**



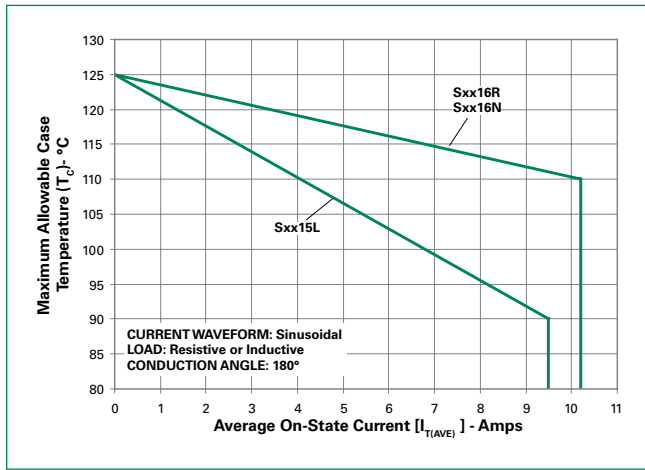
**Figure 5: Power Dissipation (Typical) vs. RMS On-State Current**



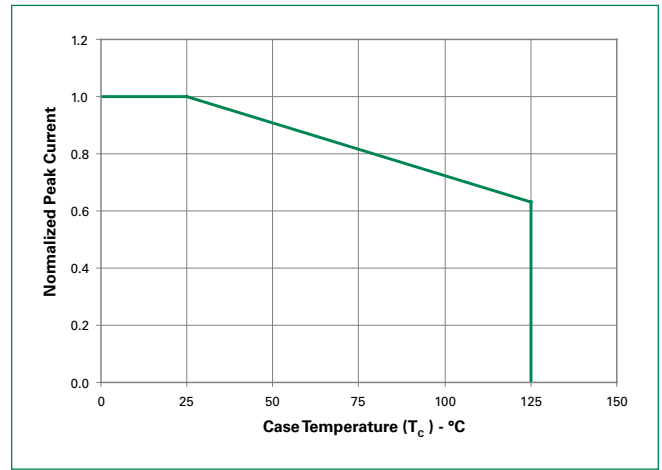
**Figure 6: Maximum Allowable Case Temperature vs. RMS On-State Current**



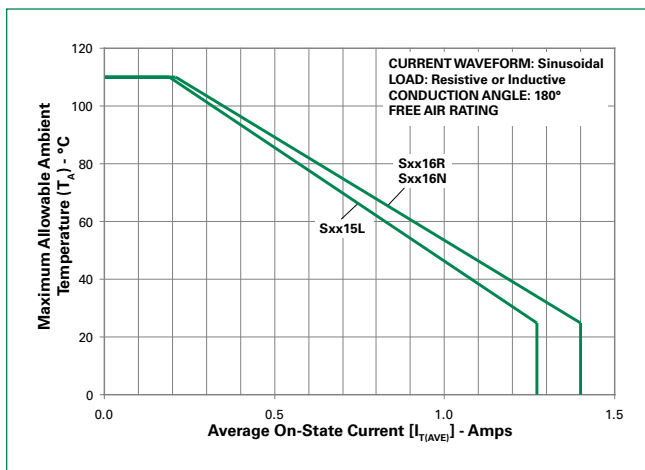
**Figure 7: Maximum Allowable Case Temperature vs. Average On-State Current**



**Figure 8: Maximum Allowable Ambient Temperature vs. RMS On-State Current**

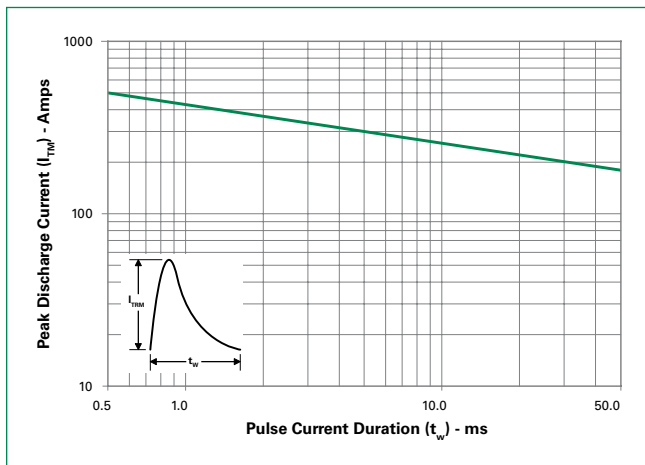


**Figure 9: Maximum Allowable Ambient Temperature vs. Average On-State Current**

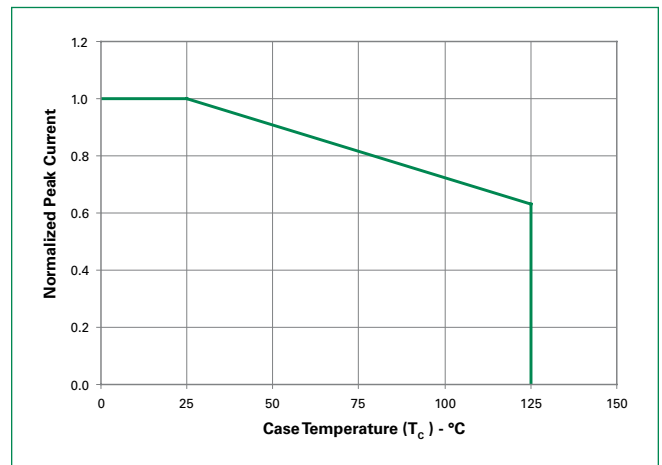


Note: xx = voltage

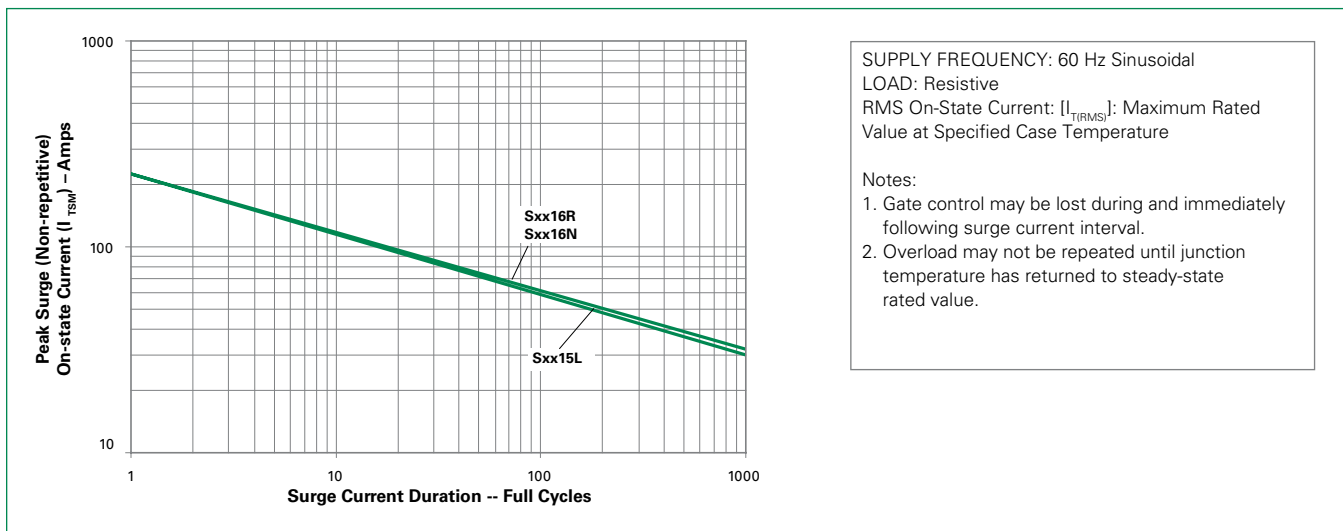
**Figure 10: Peak Capacitor Discharge Current**



**Figure 11: Peak Capacitor Discharge Current Derating**

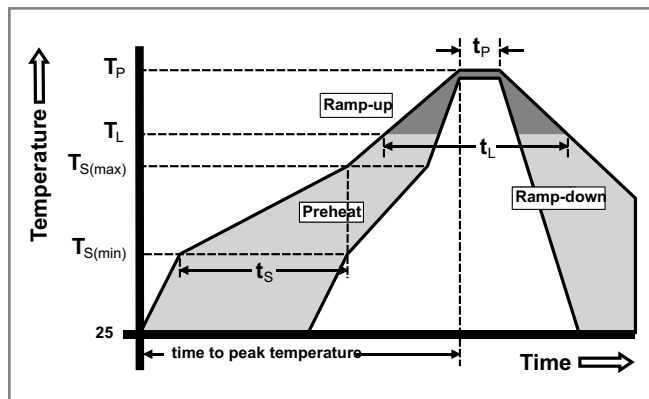


**Figure 12: Surge Peak On-State Current vs. Number of Cycles**



**Soldering Parameters**

Reflow Condition		Pb – Free assembly
Pre Heat	- Temperature Min ( $T_{s(min)}$ )	150°C
	- Temperature Max ( $T_{s(max)}$ )	200°C
	- Time (min to max) ( $t_s$ )	60 – 180 secs
Average ramp up rate (Liquidus Temp) ( $T_L$ ) to peak		5°C/second max
$T_{s(max)}$ to $T_L$ - Ramp-up Rate		5°C/second max
Reflow	- Temperature ( $T_L$ ) (Liquidus)	217°C
	- Temperature ( $t_L$ )	60 – 150 seconds
Peak Temperature ( $T_p$ )		260 <sup>+0/-5</sup> °C
Time within 5°C of actual peak Temperature ( $t_p$ )		20 – 40 seconds
Ramp-down Rate		5°C/second max
Time 25°C to peak Temperature ( $T_p$ )		8 minutes Max.
Do not exceed		280°C



### Physical Specifications

<b>Terminal Finish</b>	100% Matte Tin-plated
<b>Body Material</b>	UL recognized epoxy meeting flammability classification 94V-0
<b>Lead Material</b>	Copper Alloy

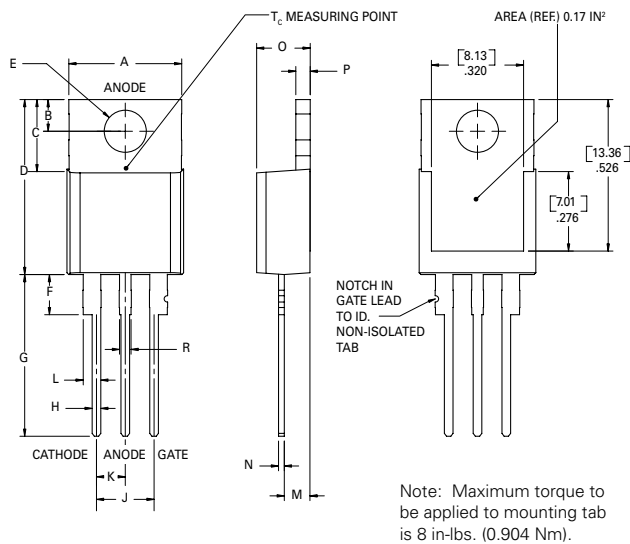
### Design Considerations

Careful selection of the correct device for the application's operating parameters and environment will go a long way toward extending the operating life of the Thyristor. Good design practice should limit the maximum continuous current through the main terminals to 75% of the device rating. Other ways to ensure long life for a power discrete semiconductor are proper heat sinking and selection of voltage ratings for worst case conditions. Overheating, overvoltage (including dv/dt), and surge currents are the main killers of semiconductors. Correct mounting, soldering, and forming of the leads also help protect against component damage.

### Environmental Specifications

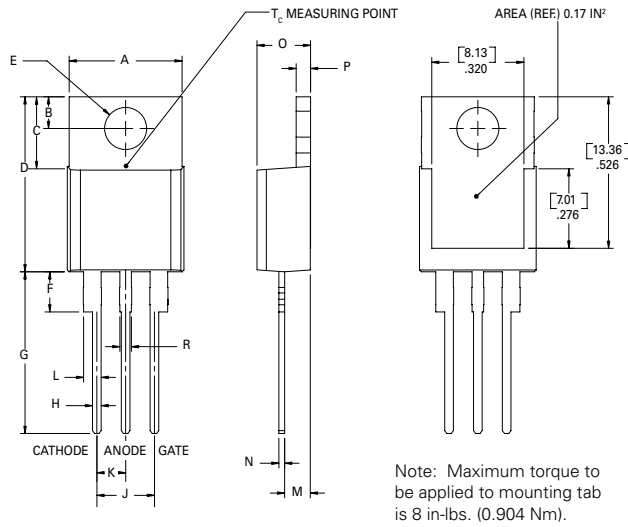
Test	Specifications and Conditions
<b>AC Blocking</b>	MIL-STD-750, M-1040, Cond A Applied Peak AC voltage @ 125°C for 1008 hours
<b>Temperature Cycling</b>	MIL-STD-750, M-1051, 100 cycles; -40°C to +150°C; 15-min dwell-time
<b>Temperature/Humidity</b>	EIA / JEDEC, JESD22-A101 1008 hours; 320V - DC: 85°C; 85% rel humidity
<b>High Temp Storage</b>	MIL-STD-750, M-1031, 1008 hours; 150°C
<b>Low-Temp Storage</b>	1008 hours; -40°C
<b>Thermal Shock</b>	MIL-STD-750, M-1056 10 cycles; 0°C to 100°C; 5-min dwell-time at each temperature; 10 sec (max) transfer time between temperature
<b>Autoclave</b>	EIA / JEDEC, JESD22-A102 168 hours (121°C at 2 ATMs) and 100% R/H
<b>Resistance to Solder Heat</b>	MIL-STD-750 Method 2031
<b>Solderability</b>	ANSI/J-STD-002, category 3, Test A
<b>Lead Bend</b>	MIL-STD-750, M-2036 Cond E

### Dimensions — TO-220AB (R-Package) — Non-Isolated Mounting Tab Common with Center Lead



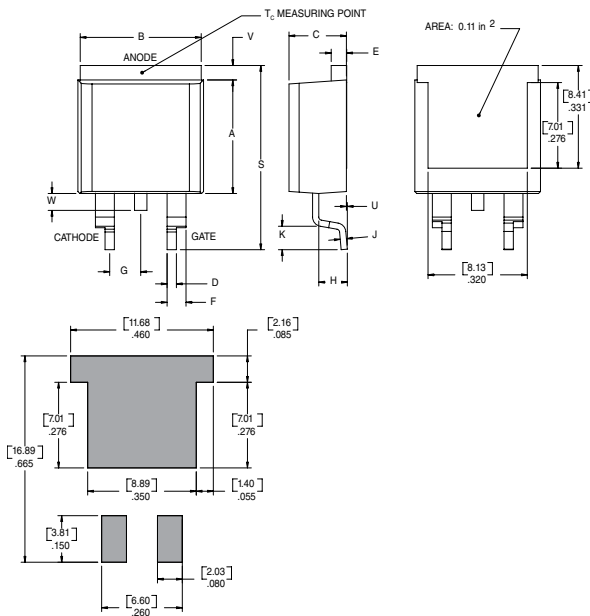
Dimension	Inches		Millimeters	
	Min	Max	Min	Max
A	0.380	0.420	9.65	10.67
B	0.105	0.115	2.67	2.92
C	0.230	0.250	5.84	6.35
D	0.590	0.620	14.99	15.75
E	0.142	0.147	3.61	3.73
F	0.110	0.130	2.79	3.30
G	0.540	0.575	13.72	14.61
H	0.025	0.035	0.64	0.89
J	0.195	0.205	4.95	5.21
K	0.095	0.105	2.41	2.67
L	0.060	0.075	1.52	1.91
M	0.085	0.095	2.16	2.41
N	0.018	0.024	0.46	0.61
O	0.178	0.188	4.52	4.78
P	0.045	0.060	1.14	1.52
R	0.038	0.048	0.97	1.22

**Dimensions — TO-220AB (L-Package) — Isolated Mounting Tab**



Dimension	Inches		Millimeters	
	Min	Max	Min	Max
A	0.380	0.420	9.65	10.67
B	0.105	0.115	2.67	2.92
C	0.230	0.250	5.84	6.35
D	0.590	0.620	14.99	15.75
E	0.142	0.147	3.61	3.73
F	0.110	0.130	2.79	3.30
G	0.540	0.575	13.72	14.61
H	0.025	0.035	0.64	0.89
J	0.195	0.205	4.95	5.21
K	0.095	0.105	2.41	2.67
L	0.060	0.075	1.52	1.91
M	0.085	0.095	2.16	2.41
N	0.018	0.024	0.46	0.61
O	0.178	0.188	4.52	4.78
P	0.045	0.060	1.14	1.52
R	0.038	0.048	0.97	1.22

**Dimensions — TO- 263AA (N-package) — D<sup>2</sup>-Pak Surface Mount**



Dimension	Inches		Millimeters	
	Min	Max	Min	Max
A	0.360	0.370	9.14	9.40
B	0.380	0.420	9.65	10.67
C	0.178	0.188	4.52	4.78
D	0.025	0.035	0.64	0.89
E	0.045	0.060	1.14	1.52
F	0.060	0.075	1.52	1.91
G	0.095	0.105	2.41	2.67
H	0.092	0.102	2.34	2.59
J	0.018	0.024	0.46	0.61
K	0.090	0.110	2.29	2.79
S	0.590	0.625	14.99	15.88
V	0.035	0.045	0.89	1.14
U	0.002	0.010	0.05	0.25
W	0.040	0.070	1.02	1.78

### Product Selector

Part Number	Voltage				Gate Sensitivity	Type	Package
	400V	600V	800V	1000V			
Sxx15L	X	X	X	X	30mA	Standard SCR	TO-220L
Sxx16R	X	X	X	X	30mA	Standard SCR	TO-220R
Sxx16N	X	X	X	X	30mA	Standard SCR	TO-263

Note: xx = Voltage

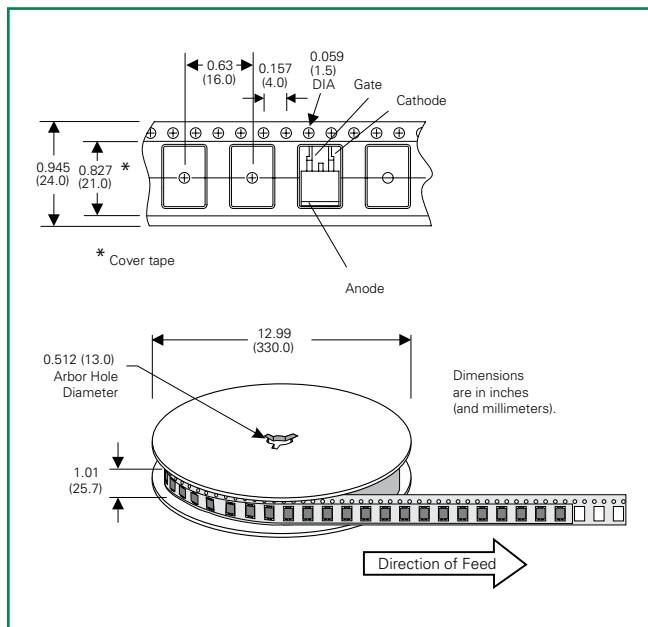
### Packing Options

Part Number	Marking	Weight	Packing Mode	Base Quantity
Sxx15L	Sxx15L	2.2 g	Bulk	500
Sxx15LTP	Sxx15L	2.2 g	Tube	500 (50 per tube)
Sxx16R	Sxx16R	2.2 g	Bulk	500
Sxx16RTP	Sxx16R	2.2 g	Tube	500 (50 per tube)
Sxx16NTP	Sxx16N	1.6 g	Tube	500 (50 per tube)
Sxx16NRP	Sxx16N	1.6 g	Embossed Carrier	500

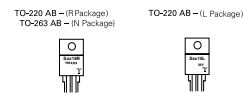
Note: xx = Voltage

### TO-263 Embossed Carrier Reel Pack (RP) Specs

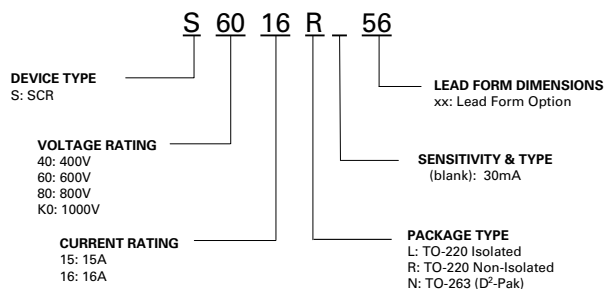
#### Meets all EIA-481-2 Standards



### Part Marking System



### Part Numbering System





Компания «Океан Электроники» предлагает заключение долгосрочных отношений при поставках импортных электронных компонентов на взаимовыгодных условиях!

Наши преимущества:

- Поставка оригинальных импортных электронных компонентов напрямую с производств Америки, Европы и Азии, а так же с крупнейших складов мира;
- Широкая линейка поставок активных и пассивных импортных электронных компонентов (более 30 млн. наименований);
- Поставка сложных, дефицитных, либо снятых с производства позиций;
- Оперативные сроки поставки под заказ (от 5 рабочих дней);
- Экспресс доставка в любую точку России;
- Помощь Конструкторского Отдела и консультации квалифицированных инженеров;
- Техническая поддержка проекта, помощь в подборе аналогов, поставка прототипов;
- Поставка электронных компонентов под контролем ВП;
- Система менеджмента качества сертифицирована по Международному стандарту ISO 9001;
- При необходимости вся продукция военного и аэрокосмического назначения проходит испытания и сертификацию в лаборатории (по согласованию с заказчиком);
- Поставка специализированных компонентов военного и аэрокосмического уровня качества (Xilinx, Altera, Analog Devices, Intersil, Interpoint, Microsemi, Actel, Aeroflex, Peregrine, VPT, Syfer, Eurofarad, Texas Instruments, MS Kennedy, Miteq, Cobham, E2V, MA-COM, Hittite, Mini-Circuits, General Dynamics и др.);

Компания «Океан Электроники» является официальным дистрибьютором и эксклюзивным представителем в России одного из крупнейших производителей разъемов военного и аэрокосмического назначения «JONHON», а так же официальным дистрибьютором и эксклюзивным представителем в России производителя высокотехнологичных и надежных решений для передачи СВЧ сигналов «FORSTAR».



## JONHON

«JONHON» (основан в 1970 г.)

Разъемы специального, военного и аэрокосмического назначения:

(Применяются в военной, авиационной, аэрокосмической, морской, железнодорожной, горно- и нефтедобывающей отраслях промышленности)

«FORSTAR» (основан в 1998 г.)

ВЧ соединители, коаксиальные кабели, кабельные сборки и микроволновые компоненты:

(Применяются в телекоммуникациях гражданского и специального назначения, в средствах связи, РЛС, а так же военной, авиационной и аэрокосмической отраслях промышленности).



Телефон: 8 (812) 309-75-97 (многоканальный)

Факс: 8 (812) 320-03-32

Электронная почта: [ocean@oceanchips.ru](mailto:ocean@oceanchips.ru)

Web: <http://oceanchips.ru/>

Адрес: 198099, г. Санкт-Петербург, ул. Калинина, д. 2, корп. 4, лит. А