



# MIC24053 Evaluation Board

## 9A, High-Efficiency, Synchronous DC/DC Buck Regulator with Hyper Speed Control™

### SuperSwitcher II™

## General Description

The MIC24053 DC/DC synchronous buck regulator operates over an input supply range of 4.5V to 19V and provides a regulated output at up to 9A of load current. The output voltage is adjustable down to 0.8V with a typical accuracy of  $\pm 1\%$ . The device operates at a switching frequency of 600kHz, which remains relatively constant with changes in input voltage and output load.

Micrel's Hyper Speed Control™ architecture allows for ultra-fast transient response, while reducing the output capacitance. It also makes (High  $V_{IN}$ )/(Low  $V_{OUT}$ ) operation possible. The 19V operating rating of the device provides adequate design safety margin for 12V input applications.

The MIC24053 utilizes an adaptive  $T_{ON}$  ripple control architecture. An undervoltage lockout feature is provided to ensure proper operation under power-sag conditions. An internal soft-start feature is provided to reduce the inrush current. Foldback current limit and "hiccup" mode short-circuit protection and thermal shutdown ensures protection of the IC during fault conditions.

The basic parameters of the MIC24053 evaluation board are a  $V_{IN}$  supply of 5V to 19V, output voltage of 0.8V to 5V at 9A<sup>(1)</sup>, and 600kHz switching frequency.

### Note:

1. Refer to the temperature curves presented in the [Evaluation Board Performance](#) section. Also, note that the typical minimum input voltage to maximum output voltage conversion is limited by the maximum duty cycle.

Datasheets and support documentation are available on Micrel's web site at: [www.micrel.com](http://www.micrel.com).

## Requirements

The MIC24053 evaluation board requires only a single power supply with at least 10A current capability. The MIC24053 has internal VDD LDO so no external linear regulator is required to power the internal biasing of the IC. When  $V_{IN} < 5.5V$ , VDD should be tied to PVIN pins to bypass the internal linear regulator by a jumper. The output load can either be an active or passive load.

## Power-Up Precautions

The evaluation board does not have reverse polarity protection. Applying a negative voltage to the  $V_{IN}$  terminal may damage the device. The maximum  $V_{IN}$  operating voltage of the MIC24053 evaluation board is 19V. It has two different layout designs, one ([Figure 1](#)) optimized for evaluation and a second ([Figure 2](#)) optimized for a smaller footprint. The evaluation board is only populated with components shown in [Figure 1](#).

## Getting Started

### 1. $V_{IN}$ Supply.

Connect a supply to the  $V_{IN}$  and GND terminals, paying careful attention to the polarity and the supply range ( $5V < V_{IN} < 19V$ ). An ammeter may be placed between the input supply and the  $V_{IN}$  terminal to the evaluation board. Ensure that the supply voltage is monitored at the  $V_{IN}$  terminal. The ammeter and/or power lead resistance can reduce the voltage supplied to the input. Do not apply power until Step 4.

### 2. Connect the load to the $V_{OUT}$ and ground terminals.

The load can be either passive (resistive) or active (as in an electronic load). An ammeter can be placed between the load and the  $V_{OUT}$  terminal. Ensure that the output voltage is monitored at the  $V_{OUT}$  terminal.

### 3. Enable Input.

An EN connector is provided on the evaluation board for users to easily access the enable feature. The output of the MIC24053 turns on when VDD exceeds the UVLO threshold. The output of the MIC24053 may be turned off by shorting the EN pin to ground.

### 4. Turn on the power.

Turn on  $V_{IN}$  power supply and verify that the output voltage is regulated to 1.8V.

## Ordering Information

Part Number	Description
MIC24053YJL EV	9A HSC DC/DC Buck Regulator Evaluation Board

Hyper Speed Control, SuperSwitcher II, and Any Capacitor are trademarks of Micrel, Inc.

Micrel Inc. • 2180 Fortune Drive • San Jose, CA 95131 • USA • tel +1 (408) 944-0800 • fax + 1 (408) 474-1000 • <http://www.micrel.com>

## Output Voltage

The output voltage on the MIC24053 evaluation board is adjustable. It is set by adjusting the feedback resistors, referring Equation 1:

$$V_{\text{OUT}} = V_{\text{FB}} \times \left( 1 + \frac{R4}{R_{\text{BOTTOM}}} \right) \quad \text{Eq. 1}$$

where  $V_{\text{FB}} = 0.8\text{V}$  and  $R_{\text{BOTTOM}}$  is one of the R5, R6, R7, R8, R9, R10, R11, R12 which corresponds to 0.9V, 1.0V, 1.2V, 1.5V, 1.8V, 2.5V, 3.3V, or 5V. Leaving the  $R_{\text{BOTTOM}}$  open gives a 0.8V output voltage. The output voltage above is set at the factory for a 1.8V output, but it can easily be changed by moving the jumper to a respective position to get an indicated voltage on the board. If a desired voltage is not shown on the board, it is easily modified by removing  $R_{\text{BOTTOM}}$  and replacing it with the values that yield the desired output voltage. Once R4 is selected,  $R_{\text{BOTTOM}}$  can be calculated using Equation 2:

$$R_{\text{BOTTOM}} = \frac{R4 \times V_{\text{FB}}}{V_{\text{OUT}} - V_{\text{FB}}} \quad \text{Eq. 2}$$

For  $V_{\text{FB}} = 0.8\text{V}$ , as in Equation 3:

$$R_{\text{BOTTOM}} = \frac{R4 \times 0.8\text{V}}{V_{\text{OUT}} - 0.8\text{V}} \quad \text{Eq. 3}$$

The output voltage should not be set to exceed 5V due to the 6.3V rating of the output capacitor and limitation on line regulation. Please refer to the "Setting the Output Voltage" and "Ripple Injection" subsections in the *Application Information* section of the MIC24053 data sheet for more detailed information.

# Evaluation Board Performance

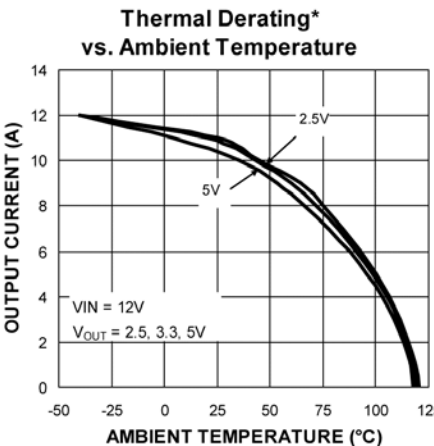
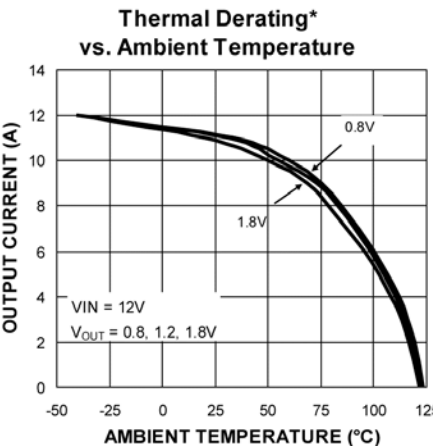
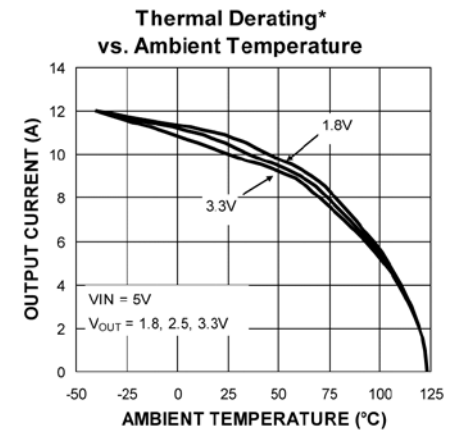
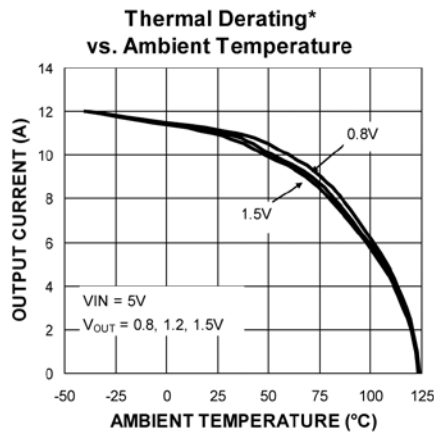
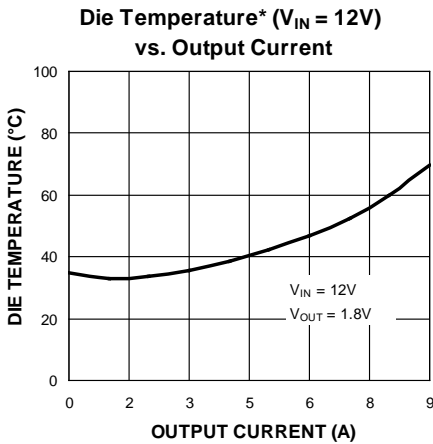
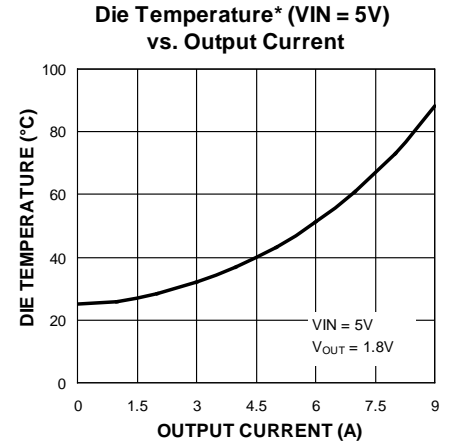
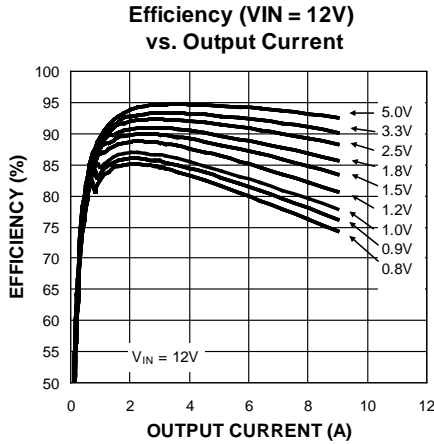
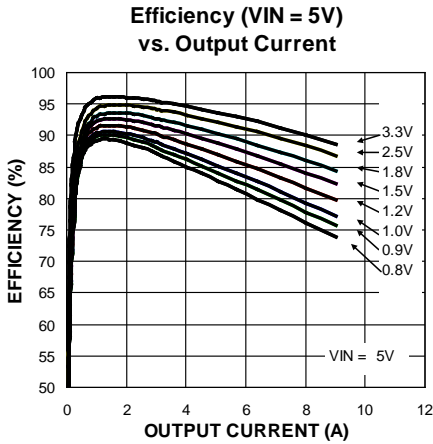

**Die Temperature\*** : The temperature measurement was taken at the hottest point on the MIC24053 case mounted on a 5 square inch 4 layer, 0.62 inch, FR-4 PCB with 2oz finish copper weight per layer, see the *Thermal Measurement* section in the MIC24053 datasheet. Actual results will depend upon the size of the PCB, ambient temperature and proximity to other heat-emitting components.

# Evaluation Board Schematic

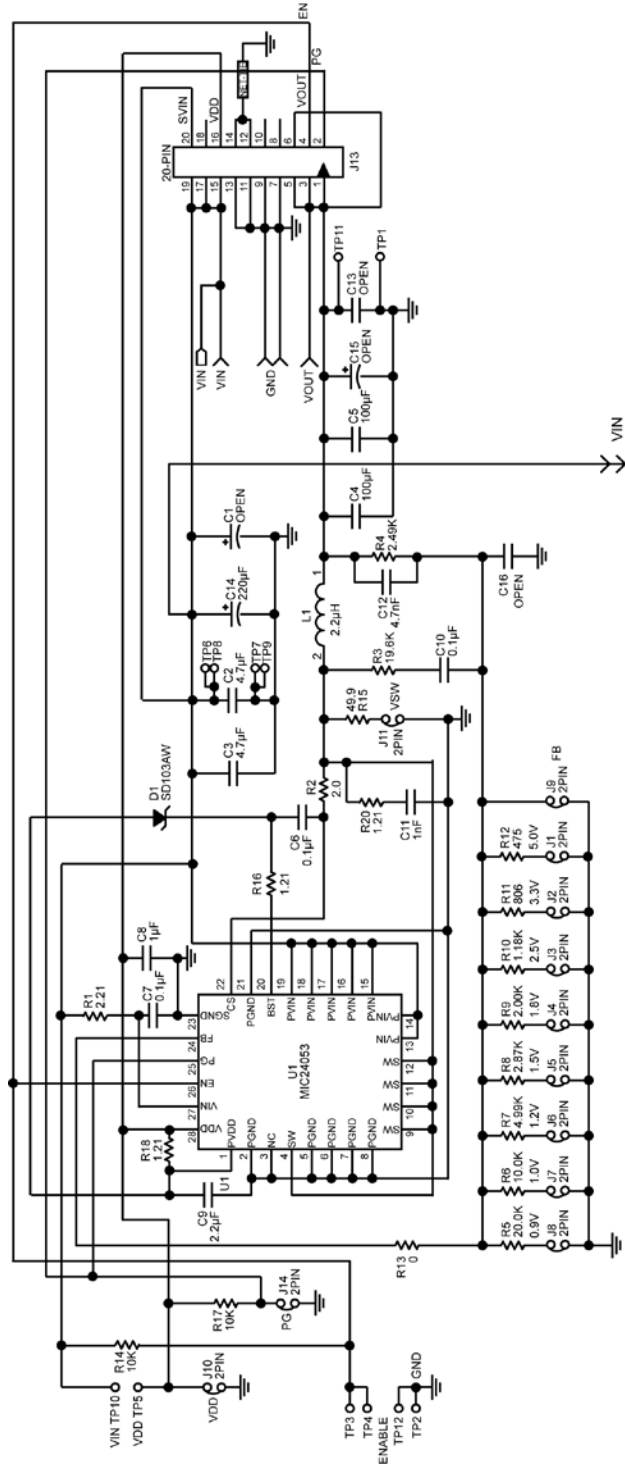

**Figure 1. Schematic of MIC24053 Evaluation Board (J11, R13, and R15 are for testing purposes)**

Evaluation Board Schematic (Continued)

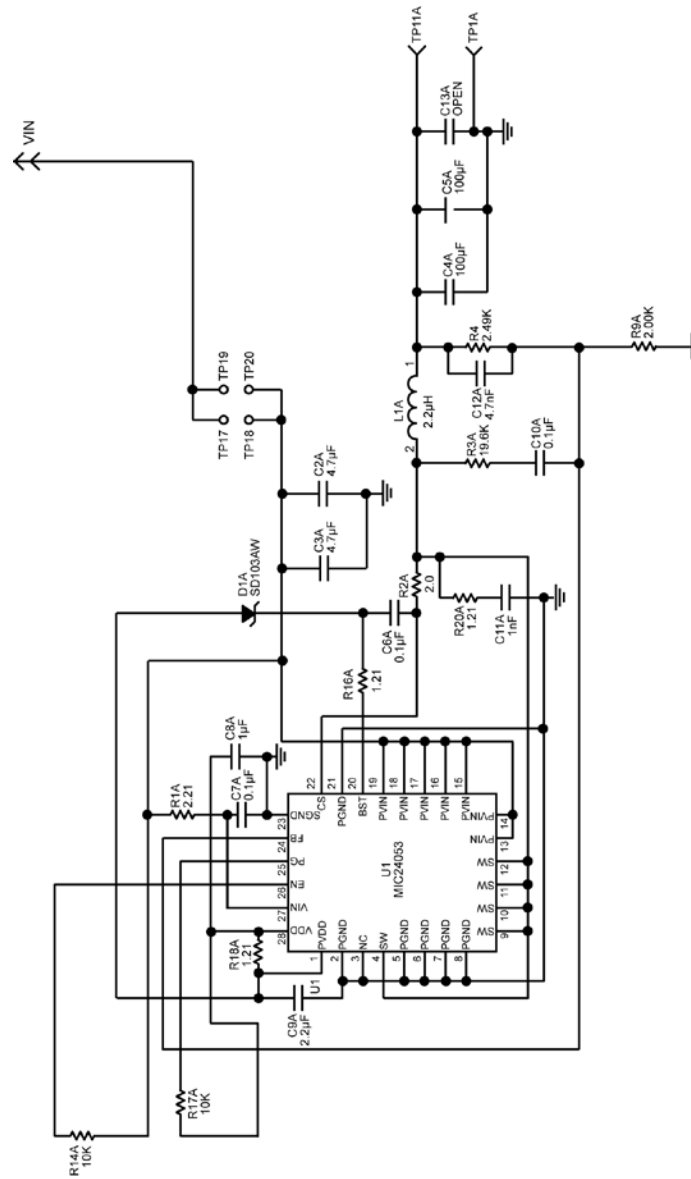

Figure 2. Schematic of MIC24053 Evaluation Board – Optimized for Smaller Footprint (J11, R13, and R15 are for testing purposes)

## Bill of Materials

Item	Part Number	Manufacturer	Description	Qty.
C1	Open			
C2, C3	12103C475KAT2A	AVX <sup>(1)</sup>	4.7µF Ceramic Capacitor, X7R, Size 1210, 25V	2
	GRM32DR71E475KA61K	Murata <sup>(2)</sup>		
	C3225X7R1E475K	TDK <sup>(3)</sup>		
C13, C15	Open			
C4, C5	12106D107MAT2A	AVX	100µF Ceramic Capacitor, X5R, Size 1210, 6.3V	2
	GRM32ER60J107ME20L	Murata		
	C3225X5R0J107M	TDK		
C6, C7, C10	06035C104KAT2A	AVX	0.1µF Ceramic Capacitor, X7R, Size 0603, 50V	3
	GRM188R71H104KA93D	Murata		
	C1608X7R1H104K	TDK		
C8	0603ZC105KAT2A	AVX	1.0µF Ceramic Capacitor, X7R, Size 0603, 10V	1
	GRM188R71A105KA61D	Murata		
	C1608X7R1A105K	TDK		
C9	0603ZD225KAT2A	AVX	2.2µF Ceramic Capacitor, X5R, Size 0603, 10V	1
	GRM188R61A225KE34D	Murata		
	C1608X5R1A225K	TDK		
C12	06035C472KAZ2A	AVX	4.7nF Ceramic Capacitor, X7R, Size 0603, 50V	1
	GRM188R71H472K	Murata		
	C1608X7R1H472K	TDK		
C14	B41851F7227M	EPCOS <sup>(4)</sup>	220µF Aluminum Capacitor, 35V	1
C11, C16	Open			
D1	SD103AWS	MCC <sup>(5)</sup>	40V, 350mA, Schottky Diode, SOD323	1
	SD103AWS-7	Diodes Inc <sup>(6)</sup>		
	SD103AWS	Vishay <sup>(7)</sup>		
L1	HCF1305-2R2-R	Cooper Bussmann <sup>(8)</sup>	2.2µH Inductor, 15A Saturation Current	1
R1	CRCW06032R21FKEA	Vishay Dale	2.21Ω Resistor, Size 0603, 1%	1
R2	CRCW06032R00FKEA	Vishay Dale	2.00Ω Resistor, Size 0603, 1%	1
R3	CRCW060319K6FKEA	Vishay Dale	19.6kΩ Resistor, Size 0603, 1%	1
R4	CRCW06032K49FKEA	Vishay Dale	2.49kΩ Resistor, Size 0603, 1%	1
R5	CRCW060320K0FKEA	Vishay Dale	20.0kΩ Resistor, Size 0603, 1%	1

### Notes:

1. AVX: [www.avx.com](http://www.avx.com).
2. Murata: [www.murata.com](http://www.murata.com).
3. TDK: [www.tdk.com](http://www.tdk.com).
4. EPCOS: [www.epcos.com](http://www.epcos.com).
5. MCC: [www.mccsemi.com](http://www.mccsemi.com).
6. Diodes, Inc.: [www.diodes.com](http://www.diodes.com).
7. Vishay: [www.vishay.com](http://www.vishay.com).
8. Cooper Bussmann: [www.cooperbussmann.com](http://www.cooperbussmann.com).

**Bill of Materials (Continued)**

Item	Part Number	Manufacturer	Description	Qty.
R6, R14, R17	CRCW060310K0FKEA	Vishay Dale	10.0k $\Omega$ Resistor, Size 0603, 1%	3
R7	CRCW06034K99FKEA	Vishay Dale	4.99k $\Omega$ Resistor, Size 0603, 1%	1
R8	CRCW06032K87FKEA	Vishay Dale	2.87k $\Omega$ Resistor, Size 0603, 1%	1
R9	CRCW06032K006FKEA	Vishay Dale	2.00k $\Omega$ Resistor, Size 0603, 1%	1
R10	CRCW06031K18FKEA	Vishay Dale	1.18k $\Omega$ Resistor, Size 0603, 1%	1
R11	CRCW0603806RFKEA	Vishay Dale	806 $\Omega$ Resistor, Size 0603, 1%	1
R12	CRCW0603475RFKEA	Vishay Dale	475 $\Omega$ Resistor, Size 0603, 1%	1
R13	CRCW06030000FKEA	Vishay Dale	0 $\Omega$ Resistor, Size 0603, 5%	1
R15	CRCW060349R9FKEA	Vishay Dale	49.9 $\Omega$ Resistor, Size 0603, 1%	1
R16, R18	CRCW06031R21FKEA	Vishay Dale	1.21 $\Omega$ Resistor, Size 0603, 1%	2
R20	Open			
All Reference designators ending with an "A"	Open			
<b>U1</b>	<b>MIC24053YJL</b>	<b>Micrel, Inc.<sup>(9)</sup></b>	<b>9A, High-Efficiency, Synchronous DC/DC Buck Regulator with Hyper Speed Control</b>	<b>1</b>

**Note:**

9. Micrel, Inc.: [www.micrel.com](http://www.micrel.com).

# PCB Layout Recommendations<sup>(1)</sup>

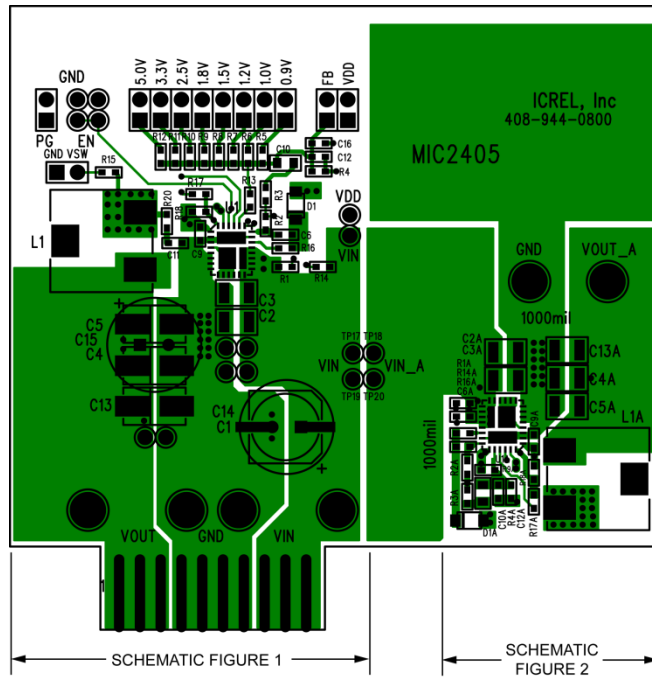

Top Layer

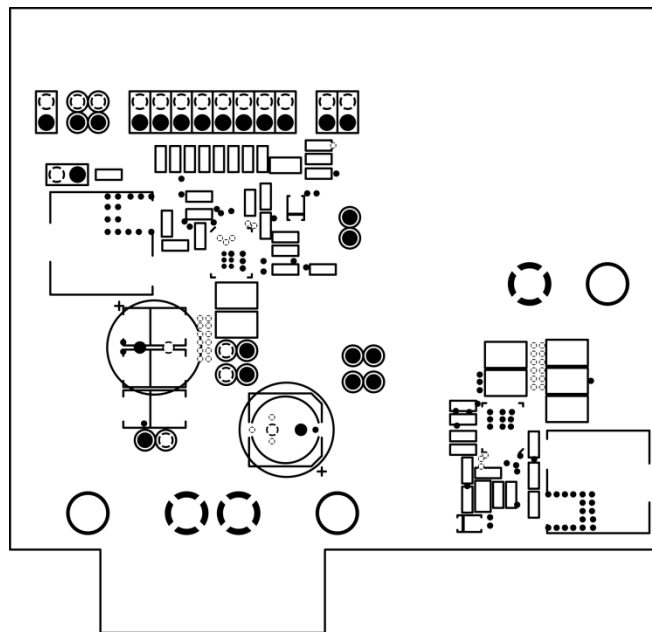

Mid-Layer 1

**Note:**

1. Refer to "PCB Layout Guideline" section for component placement and layout in MIC24053 datasheet on Micrel web page ([www.micrel.com](http://www.micrel.com))



# PCB Layout Recommendations<sup>(1)</sup> (Continued)

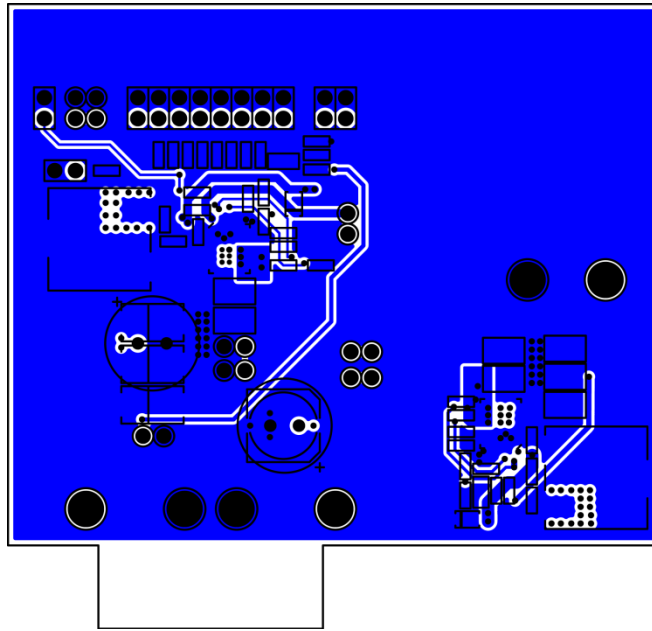

Mid-Layer 2

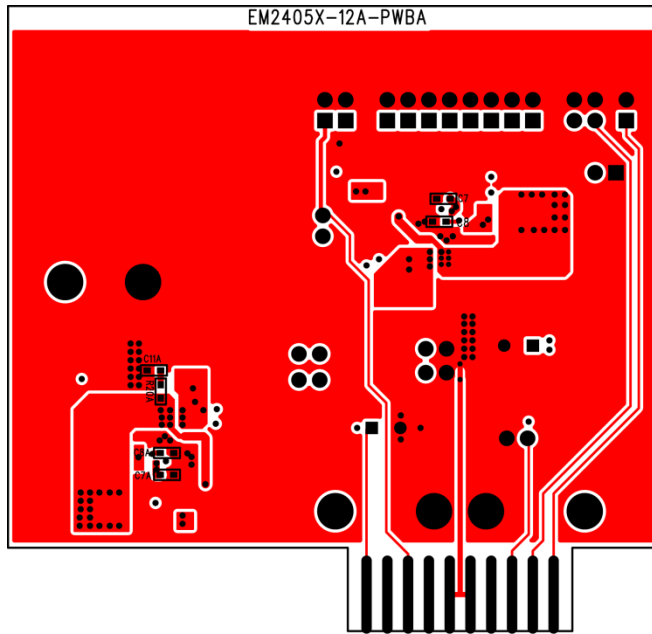

Bottom Layer

---

**MICREL, INC. 2180 FORTUNE DRIVE SAN JOSE, CA 95131 USA**TEL +1 (408) 944-0800 FAX +1 (408) 474-1000 WEB <http://www.micrel.com>

Micrel makes no representations or warranties with respect to the accuracy or completeness of the information furnished in this data sheet. This information is not intended as a warranty and Micrel does not assume responsibility for its use. Micrel reserves the right to change circuitry, specifications and descriptions at any time without notice. No license, whether express, implied, arising by estoppel or otherwise, to any intellectual property rights is granted by this document. Except as provided in Micrel's terms and conditions of sale for such products, Micrel assumes no liability whatsoever, and Micrel disclaims any express or implied warranty relating to the sale and/or use of Micrel products including liability or warranties relating to fitness for a particular purpose, merchantability, or infringement of any patent, copyright or other intellectual property right.

Micrel Products are not designed or authorized for use as components in life support appliances, devices or systems where malfunction of a product can reasonably be expected to result in personal injury. Life support devices or systems are devices or systems that (a) are intended for surgical implant into the body or (b) support or sustain life, and whose failure to perform can be reasonably expected to result in a significant injury to the user. A Purchaser's use or sale of Micrel Products for use in life support appliances, devices or systems is a Purchaser's own risk and Purchaser agrees to fully indemnify Micrel for any damages resulting from such use or sale.

© 2013 Micrel, Incorporated.

# Mouser Electronics

Authorized Distributor

Click to View Pricing, Inventory, Delivery & Lifecycle Information:

[Micrel:](#)

[MIC24053YJL-EV](#)

Компания «Океан Электроники» предлагает заключение долгосрочных отношений при поставках импортных электронных компонентов на взаимовыгодных условиях!

Наши преимущества:

- Поставка оригинальных импортных электронных компонентов напрямую с производств Америки, Европы и Азии, а так же с крупнейших складов мира;
- Широкая линейка поставок активных и пассивных импортных электронных компонентов (более 30 млн. наименований);
- Поставка сложных, дефицитных, либо снятых с производства позиций;
- Оперативные сроки поставки под заказ (от 5 рабочих дней);
- Экспресс доставка в любую точку России;
- Помощь Конструкторского Отдела и консультации квалифицированных инженеров;
- Техническая поддержка проекта, помощь в подборе аналогов, поставка прототипов;
- Поставка электронных компонентов под контролем ВП;
- Система менеджмента качества сертифицирована по Международному стандарту ISO 9001;
- При необходимости вся продукция военного и аэрокосмического назначения проходит испытания и сертификацию в лаборатории (по согласованию с заказчиком);
- Поставка специализированных компонентов военного и аэрокосмического уровня качества (Xilinx, Altera, Analog Devices, Intersil, Interpoint, Microsemi, Actel, Aeroflex, Peregrine, VPT, Syfer, Eurofarad, Texas Instruments, MS Kennedy, Miteq, Cobham, E2V, MA-COM, Hittite, Mini-Circuits, General Dynamics и др.);

Компания «Океан Электроники» является официальным дистрибьютором и эксклюзивным представителем в России одного из крупнейших производителей разъемов военного и аэрокосмического назначения «JONHON», а так же официальным дистрибьютором и эксклюзивным представителем в России производителя высокотехнологичных и надежных решений для передачи СВЧ сигналов «FORSTAR».



## JONHON

«JONHON» (основан в 1970 г.)

Разъемы специального, военного и аэрокосмического назначения:

(Применяются в военной, авиационной, аэрокосмической, морской, железнодорожной, горно- и нефтедобывающей отраслях промышленности)

«FORSTAR» (основан в 1998 г.)

ВЧ соединители, коаксиальные кабели, кабельные сборки и микроволновые компоненты:

(Применяются в телекоммуникациях гражданского и специального назначения, в средствах связи, РЛС, а так же военной, авиационной и аэрокосмической отраслях промышленности).



Телефон: 8 (812) 309-75-97 (многоканальный)

Факс: 8 (812) 320-03-32

Электронная почта: [ocean@oceanchips.ru](mailto:ocean@oceanchips.ru)

Web: <http://oceanchips.ru/>

Адрес: 198099, г. Санкт-Петербург, ул. Калинина, д. 2, корп. 4, лит. А