

# 3G3MX2

## Designed With Machine Automation in Mind

- Current vector control
- High starting torque: 200% at 0.5Hz
- Double rating VT 120%/1min and CT 150%/1min
- Speed range up to 1000 Hz
- IM & PM motor control
- Torque control in open loop vector
- Positioning functionality
- Built-in application functionality (i.e. Brake control)
- User programmable as standard
- Safety embedded compliant with ISO13849-1 (double input circuit and external device monitor EDM)
- USB port for PC programming
- 24 VDC backup supply for control board
- Fieldbus communications: Modbus, DeviceNet, Profibus, Componet, Ethercat, ML-II and CanOpen
- PC configuration tool: CX-Drive
- RoHS, CE, cULus

## Ratings

- 200 V Class single-phase 0.2 to 2.2 kW (1/8 to 3.0 HP)
- 200 V Class three-phase 0.2 to 15.0 kW (1/8 to 20 HP)
- 400 V Class three-phase 0.4 to 15.0 kW (1/2 to 20 HP)



## System configuration



**Specifications**

Type designation



**200 V class 3G3MX-A**

Single-phase: MX2□		AB001	AB002	AB004	AB007 <sup>1</sup>	AB015	AB022	-	-	-	-	-	
Three-phase: MX2□		A2001	A2002	A2004	A2007	A2015	A2022	A2037	A2055	A2075	A2011	A2150	
Motor kW <sup>2</sup>	For VT setting	0.2	0.4	0.55	1.1	2.2	3.0	5.5	7.5	11	15	18.5	
	For CT setting	0.1	0.2	0.4	0.75	1.5	2.2	3.7	5.5	7.5	11	15	
Output characteristics	Inverter capacity kVA	200 VT	0.4	0.6	1.2	2.0	3.3	4.1	6.7	10.3	13.8	19.3	23.9
		200 CT	0.2	0.5	1.0	1.7	2.7	3.8	6.0	8.6	11.4	16.2	20.7
		240 VT	0.4	0.7	1.4	2.4	3.9	4.9	8.1	12.4	16.6	23.2	28.6
		240 CT	0.3	0.6	1.2	2.0	3.3	4.5	7.2	10.3	13.7	19.5	24.9
Rated output current (A) at VT		1.2	1.9	3.5	6.0	9.6	12.0	19.6	30.0	40.0	56.0	69.0	
Rated output current (A) at CT		1.0	1.6	3.0	5.0	8.0	11.0	17.5	25.0	33.0	47.0	60.0	
Max. output voltage		Proportional to input voltage: 0..240 V											
Max. output frequency		1000 Hz <sup>3</sup>											
Power supply	Rated input voltage and frequency		Single-phase 200..240 V 50/60 Hz 3-phase 200..240 V 50/60 Hz										
	Allowable voltage fluctuation		-15%..+10%										
	Allowable frequency fluctuation		5%										
Braking torque		At short-time deceleration At capacitor feedback				100%: <50Hz 50%: <60Hz		70%: <50Hz 50%: <60Hz		Approx 20%		-	
Cooling method		Self cooling					Forced-air-cooling						

1. Single phase model use forced air cooling but three phase model is self cooling.
2. Based on a standard 3-Phase standard motor.
3. Above 400Hz with some function limitation.

**400 V class 3G3MX-A4**

Three-phase: MX2□		A4004	A4007	A4015	A4022	A4030	A4040	A4055	A4075	A4110	A4150	
Motor kW <sup>1</sup>	For VT setting	0.75	1.5	2.2	3.0	4.0	5.5	7.5	11	15	18.5	
	For CT setting	0.4	0.75	1.5	2.2	3.0	4.0	5.5	7.5	11	15	
Output characteristics	Inverter capacity kVA	380 VT	1.3	2.6	3.5	4.5	5.7	7.3	11.5	15.1	20.4	25.0
		380 CT	1.1	2.2	3.1	3.6	4.7	6.0	9.7	11.8	15.7	20.4
		480 VT	1.7	3.4	4.4	5.7	7.3	9.2	14.5	19.1	25.7	31.5
		480 CT	1.4	2.8	3.9	4.5	5.9	7.6	12.3	14.9	19.9	25.7
Rated output current (A) at VT		2.1	4.1	5.4	6.9	8.8	11.1	17.5	23.0	31.0	38.0	
Rated output current (A) at CT		1.8	3.4	4.8	5.5	7.2	9.2	14.8	18.0	24.0	31.0	
Max. output voltage		Proportional to input voltage: 0..480 V										
Max. output frequency		1000 Hz <sup>2</sup>										
Power supply	Rated input voltage and frequency		3-phase 380..480 V 50/60 Hz									
	Allowable voltage fluctuation		-15%..+10%									
	Allowable frequency fluctuation		5%									
Braking torque		At short-time deceleration <sup>+3</sup> At capacitor feedback				100%: <50Hz 50%: <60Hz		70%: <50Hz 50%: <60Hz		-		
Cooling method		Forced-air-cooling										

1. Based on a standard 3-Phase standard motor.
2. Above 400Hz with some function limitation.

**Specifications**

**Common specifications**

Model number 3G3MX□		Specifications	
Control functions	Control methods	Phase-to-phase sinusoidal pulse with modulation PWM (Sensorless vector control, close loop vector with motor feedback, V/F)	
	Output frequency range	0.10..1000.00 Hz (with restrictions above 400Hz)	
	Frequency precision	Digital set value: ±0.01% of the max. frequency Analogue set value: ±0.2% of the max. frequency (25 ±10 °C)	
	Resolution of frequency set value	Digital set value: 0.01 Hz Analogue set value: 1/1000 of maximum frequency	
	Resolution of output frequency	0.01Hz	
	Starting torque	200% / 0.5Hz	
	Overload capability	Dual rating: Heavy duty (CT): 150% for 1 minute Normal Duty (VT): 120% for 1 minute	
	Frequency set value	0 to 10 VDC (10KΩ), 4 to 20mA (100Ω), RS485 Modbus, Network options	
	V/f Characteristics	Constant/ reduced torque, free V/f	
Functionality	Inputs signals	FW (forward run command), RV (reverse run command), CF1~CF4 (multi-stage speed setting), JG (jog command), DB (external braking), SET (set second motor), 2CH (2-stage accel./decel. command), FRS (free run stop command), EXT (external trip), USP (startup function), CS (commercial power switchover), SFT (soft lock), AT (analog input selection), RS (reset), PTC (thermistor thermal protection), STA (start), STP (stop), F/R (forward/reverse), PID (PID disable), PIDC (PID reset), UP (remote control up function), DWN (remote control down function), UDC (remote control data clear), OPE (operator control), SF1~SF7 (multi-stage speed setting; bit operation), OLR (overload restriction), TL (torque limit enable), TRQ1 (torque limit changeover1), TRQ2 (torque limit changeover2), BOK (Braking confirmation), LAC (LAD cancellation), PCLR (position deviation clear), ADD (add frequency enable), F-TM (force terminal mode), ATR (permission of torque command input), KHC (Cumulative power clear), MI1~MI7 (general purpose inputs for EzSQ), AHD (analog command hold), CP1~CP3 (multistage-position switches), ORL (limit signal of zero-return), ORC (trigger signal of zero-return), SPD (speed/position changeover), GS1~GS2 (STO inputs, safety related signals), 485 (Starting communication signal), PRG (executing EzSQ program), HLD (retain output frequency), ROK (permission of run command), EB (rotation direction detection of B-phase), DISP (display limitation), OP (option control signal), NO (no function)	
	Output signals	RUN (run signal), FA1~FA5 (frequency arrival signal), OL,OL2 (overload advance notice signal), OD (PID deviation error signal), AL (alarm signal), OTQ (over/under torque threshold), UV (under-voltage), TRQ (torque limit signal), RNT (run time expired), ONT (power ON time expired), THM (thermal warning), BRK (brake release), BER (brake error), ZS (0Hz detection), DSE (speed deviation excessive), POK (positioning completion), ODc (analog voltage input disconnection), OIdc (analog current input disconnection), FBV (PID second stage output), NDc (network disconnect detection), LOG1~LOG3 (Logic output signals), WAC (capacitor life warning), WAF (cooling fan warning), FR (starting contact), OHF (heat sink overheat warning), LOC (Low load), MO1~MO3 (general outputs for EzSQ), IRDY (inverter ready), FWR (forward operation), RVR (reverse operation), MJA (major failure), WCO (window comparator O), WCOI (window comparator OI), FREF (frequency command source), REF (run command source), SETM (second motor in operation), EDM (STO (safe torque off) performance monitor), OP (option control signal), NO (no function)	
	Standard functions	Free-V/f, manual/automatic torque boost, output voltage gain adjustment, AVR function, reduced voltage start, motor data selection, auto-tuning, motor stabilization control, reverse running protection, simple position control, simple torque control, torque limiting, automatic carrier frequency reduction, energy saving operation, PID function, non-stop operation at instantaneous power failure, brake control, DC injection braking, dynamic braking (BRD), frequency upper and lower limiters, jump frequencies, curve accel and decel (S, U, inversed U,EL-S), 16-stage speed profile, fine adjustment of start frequency, accel and decel stop, process jogging, frequency calculation, frequency addition, 2-stage accel/decel, stop mode selection, start/end freq., analog input filter, window comparators, input terminal response time, output signal delay/hold function, rotation direction restriction, stop key selection, software lock, safe stop function, scaling function, display restriction, password function, user parameter, initialization, initial display selection, cooling fan control, warning, trip retry, frequency pull-in restart, frequency matching, overload restriction, over current restriction, DC bus voltage AVR	
	Analogue inputs	2 analogue inputs 0 to 10V (10KΩ), 4 to 20mA (100Ω)	
	Pulse train input terminal	0 to 10V (up to 24V), up to 32KHz	
	Accel/Decel times	0.01 to 3600.0s (line/curve selection), 2nd accel/decel setting available	
	Display	Status indicator LED's Run, Program, Alarm, Power, Hz, Amps Digital operator: Available to monitor 32 items: frequency reference, output current, output frequency...	
	Protection functions	Motor overload protection	Electronic Thermal overload relay and PTC thermistor input
		Instantaneous overcurrent	200% of rated current
		Overload	Dual rating: Heavy duty (CT): 150% for 1 minute Normal Duty (VT): 120% for 1 minute
Overvoltage		800V for 400V type and 400V for 200V type	
Undervoltage		345V for 400V type and 172.5V for 200V type	
Momentary power loss		Following items are selectable: Alarm, decelerates to stop, decelerates to stop with DC bus controlled, restart	
Cooling fin overheat		Temperature monitor and error detection	
Stall prevention level		Stall prevention during acceleration/deceleration and constant speed	
Ground fault		Detection at power-on	
Ambient conditions	Power charge indication	On when power is supplied to the control part	
	Degree of protection	IP20, Varnish coating on PCB	
	Ambient humidity	90% RH or less (without condensation)	
	Storage temperature	-20 °C..+65 °C (short-term temperature during transportation)	
	Ambient temperature	-10°C to 40°C	
	Vibration	Indoor (no corrosive gas, dust, etc.) Max. 1000 m 5.9 m/s <sup>2</sup> (0.6G), 10 to 55 Hz	

**Dimensions**



Voltage class	Inverter model	MX2 □	Figure	Dimensions in mm								Weight (KG)	
				W	W1	H	H1	t	D	D1	D2		d
Single-phase 200 V	AB001		1	68	56	128	118	-	109	13.5	-	-	1.0
	AB002	1	1.0										
	AB004	1	1.1										
	AB007	2	108	96	128	118	123		27	1.4			
	AB015	2					1.8						
AB022	2	1.8											
Three-phase 200 V	A2001		1	68	56	128	118	-	109	13.5	-	-	1.0
	A2002	1	1.0										
	A2004	1	1.1										
	A2007	1	146	50	1.2								
	A2015	2	108	96	128	118	170.5		55	4.4	4.5	1.6	
	A2022	2					1.8						
	A2037	3	140	128	128	118	5		170.5	55	4.4	4.5	2.0
	A2055	3	140	122	260	248	6		155	73.3	6	6	3.0
	A2075	3											3.4
	A2110	3	180	160	296	284	7		175	97	5	7	5.1
A2150	3	220	192	350	336	7	175	84	5	7	7.4		
Three-phase 400 V	A4004		2	108	96	128	118	-	144	28	-	-	1.5
	A4007	2	1.6										
	A4015	2	1.8										
	A4022	2	1.9										
	A4030	2	1.9										
	A4040	3	140	128	128	118	5		171	55	4.4	4.5	2.1
	A4055	3		122	260	248	6		155	73.3	6	6	3.5
	A4075	3		3.5									
	A4110	3	180	160	296	284	7		175	97	5	7	4.7
A4150	3	5.2											

**Rasmi footprint Filters 3G3AX-FIM**



Rasmi model		Dimensions in mm					
		W	H	L	X	Y	M
1x200 V	AX-FIM1010-RE	71	45	169	156	51	M4
	AX-FIM1014-RE	111	50	169	156	91	M4
	AX-FIM1024-RE	111	50	169	156	91	M4
3x200 V	AX-FIM2010-RE	Under development					
	AX-FIM2020-RE						
	AX-FIM2030-RE						
	AX-FIM2060-RE						
	AX-FIM2080-RE						
3x400 V	AX-FIM3005-RE	111	45	169	156	91	M4
	AX-FIM3010-RE	111	45	169	156	91	M4
	AX-FIM3014-RE	144	50	174	161	120	M4
	AX-FIM3030-RE	150	52	306	290	122	M5
	AX-FIM3050-RE	182	62	357	330	160	M5

Option board



Input AC Reactor 3G3AX-RAI

Voltage	Reference	Dimensions in mm						Weight Kg
		A	B2	C2	D	E	F	
200V	AX-RAI02800080-DE	120	70	120	80	52	5.5	1.78
	AX-RAI00880200-DE	120	80	120	80	62	5.5	2.35
	AX-RAI00350335-DE	180	85	190	140	55	6	5.5
	AX-RAI00180670-DE	180	85	190	140	55	6	5.5
400V	AX-RAI07700050-DE	120	70	120	80	52	5.5	1.78
	AX-RAI03500100-DE	120	80	120	80	62	5.5	2.35
	AX-RAI01300170-DE	120	80	120	80	62	5.5	2.50
	AX-RAI00740335-DE	180	85	190	140	55	6	5.5



DC Reactor 3G3ZX-RC

Voltage	Reference	Dimensions in mm								Weight Kg	
		A	B	C	D	E	F	G	H		
200V	AX-RC21400016-RE	84	113	96	101	66	5	7.5	2	1.22	
	AX-RC10700032-RE			105							1.60
	AX-RC06750061-RE			116							1.95
	AX-RC03510093-RE			124							120
	AX-RC02510138-RE	108	135	124	120	82	6.5	9.5	3.20	3.20	
	AX-RC01600223-RE	120	152	136	135	94	7	9.5	-	5.20	
	AX-RC01110309-RE	146	6.00								
	AX-RC00840437-RE	150	177	160	160	115	2	-	11.4		
	AX-RC00590614-RE	182.6	14.3								
	AX-RC00440859-RE	182.6	14.3								
400V	AX-RC43000020-RE	84	113	96	101	66	5	7.5	2	1.22	
	AX-RC27000030-RE			105							1.60
	AX-RC14000047-RE			116							1.95
	AX-RC10100069-RE			124							120
	AX-RC06400116-RE	108	135	133	120	82	6.5	9.5	3.70	3.70	
	AX-RC04410167-RE	120	152	136	135	94	7	9.5	-	5.20	
	AX-RC03350219-RE	146	6.00								
	AX-RC02330307-RE	150	177	160	160	115	7	2	-	11.4	
	AX-RC01750430-RE	182.6	14.3								



Output AC Reactor 3G3AX-RAO

Voltage	Reference	Dimensions in mm						Weight Kg
		A	B2	C2	D	E	F	
200V	AX-RAO11500026-DE	120	70	120	80	52	5.5	1.78
	AX-RAO07600042-DE	120	70	120	80	52	5.5	1.78
	AX-RAO04100075-DE	120	80	120	80	62	5.5	2.35
	AX-RAO03000105-DE	120	80	120	80	62	5.5	2.35
	AX-RAO01830180-DE	180	85	190	140	55	6	5.5
	AX-RAO01150220-DE	180	85	190	140	55	6	5.5
	AX-RAO00950320-DE	180	85	205	140	55	6	6.5
	AX-RAO00630430-DE	180	95	205	140	65	6	9.1
	AX-RAO00490640-DE	180	95	205	140	65	6	9.1



Voltage	Reference	Dimensions in mm						Weight Kg
		A	B2	C2	D	E	F	
400V	AX-RAO16300038-DE	120	70	120	80	52	5.5	1.78
	AX-RAO11800053-DE	120	80	120	80	52	5.5	2.35
	AX-RAO07300080-DE	120	80	120	80	62	5.5	2.35
	AX-RAO04600110-DE	180	85	190	140	55	6	5.5
	AX-RAO03600160-DE	180	85	205	140	55	6	6.5
	AX-RAO02500220-DE	180	95	205	140	55	6	9.1
	AX-RAO02000320-DE	180	105	205	140	85	6	11.7

**Chokes 3G3AX-FEJ**

Reference	D diameter	Motor KW	Dimensions in mm						Weight Kg
			L	W	H	X	Y	m	
AX-FEJ2102-RE	21	< 2.2	85	22	46	70	-	5	0.1
AX-FEJ2515-RE	25	< 15	105	25	62	90	-	5	0.2
AX-FEJ5045-RE	50	< 45	150	50	110	125	30	5	0.7

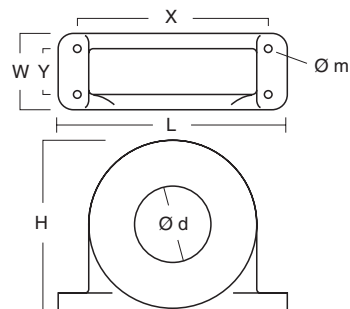

**Resistor Dimensions 3G3AX-REM**

AX-REM00K1200

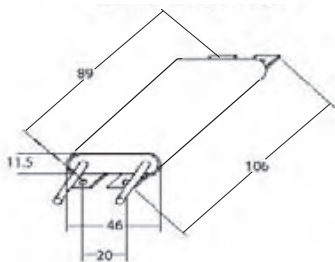

Fig 1

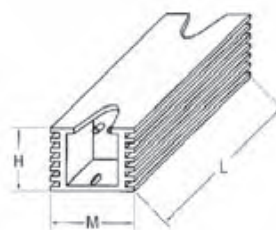

Fig 2

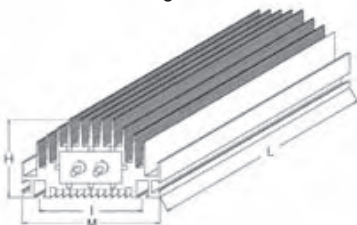

Fig 3

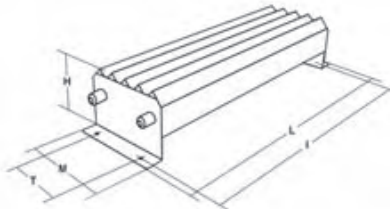
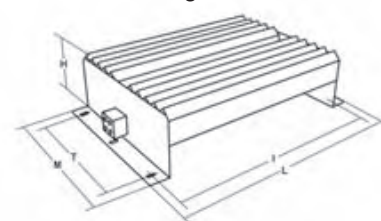

Fig 4



Type	Fig.	Dimensions in mm					Weight KG
		L	H	M	I	T	
AX-REM00K1400-IE	1	105	27	36	94	-	0.2
AX-REM00K2070-IE							
AX-REM00K2120-IE							
AX-REM00K2200-IE							
AX-REM00K4075-IE							
AX-REM00K4035-IE							
AX-REM00K4030-IE							
AX-REM00K5120-IE							
AX-REM00K6100-IE							
AX-REM00K6035-IE	2	200	62	100	74	-	1.41
AX-REM00K9070-IE							
AX-REM00K9017-IE	3	365	73	105	350	70	4
AX-REM01K9070-IE							
AX-REM01K9017-IE	4	310	100	240	295	210	7
AX-REM02K1070-IE							
AX-REM02K1017-IE							
AX-REM03K5035-IE							
AX-REM03K5010-IE		365	100	240	350	210	8



Standard connections



Terminal Block Specifications

Terminal	Name	Function (signal level)
R/L1, S/L2, T/L3	Main circuit power supply input	Used to connect line power to the drive. Drives with single-phase 200 V input power use only terminals R/L1 and N (T/L3), terminal S/L2 is not available for these units
U/T1, V/T2, W/T3	Inverter output	Used to connect the motor
PD/+1, P/+	External DC reactor terminal	Normally connected by the short-circuit bar. Remove the short-circuit bar between +1 and P/+2 when a DC reactor is connected.
P/+, N/-	Regenerative braking unit terminal	Connect optional regenerative braking units (If a braking torque is required)
P/+, RB	Braking resistor terminals	Connect option braking resistor (if a braking torque is required)
⊕	Grounding	For grounding (grounding should conform to the local grounding code.)

Control Circuit

Type	No.	Signal name	Function	Signal level
Digital input signals	PLC	Intelligent input common	Source type: connecting [P24] to [1]-[7] turns inputs ON Sink type: connecting [L] to [1]-[7] turns inputs ON	-
	P24	Internal 24 VDC	24 VDC, 30mA	24VDC, 30mA
	1	Multi-function Input selection 1	Factory setting: Forward/ Stop	27 VDC max
	2	Multi-function Input selection 2	Factory setting: Reverse/ Stop	
	3/ST1	Multi-function Input selection 3 / safe stop input 1	Factory setting: External trip	
	4/ST2	Multi-function Input selection 4 / safe stop input 2	Factory setting: Reset	
	5/PTC	Multi-function Input selection 5 / PTC thermistor input	Factory setting: Multi-step speed reference 1	
	6	Multi-function input selection 6	Factory setting: Multi-step speed reference 2	
	7/EB	Multi-function input selection 7 / Pulse train input B	Factory setting: Jog	
	L	Multi-function Input selection common (in upper row)	--	
Pulse train	EA	Pulse train input A	Factory setting: Speed reference	32KHz max 5 to 24VDC
	EO	Pulse train output	LAD frequency	10VDC 2mA 32KHz max
Analog input signal	H	Frequency reference power supply	10 V DC 10mA max	
	O	Voltage frequency reference signal	0 to 10V DC (10KΩ)	
	OI	Current frequency reference signal	4 to 20mA (250Ω)	
	L	Frequency reference common (bottom row)	--	
Digital output signals	11/EDM	Discrete logic output 1 / EDM output	Factory setting: During Run	27 VDC, 50mA max EDM based on ISO13849-1
	12	Discrete logic output 2	Factory setting: Frequency arrival type 1	
	CMD	GND logic output	--	
	AL0	Relay common contact	Factory setting: Alarm signal Under normal operation AL1 - AL0 Closed AL2 - AL0 Open	R load 250VAC 2.5A 30VDC 3.0 A I load 250VAC 0.2A 30VDC 0.7A
	AL1	Relay contact, normally open		
	AL2	Relay contact, normally closed		
Monitor Signal	AM	Analog voltage output	Factory setting: LAD frequency	0 to 10VDC 1mA
Comms	SP	Serial communication terminal	RS485 Modbus communication	
	SN			

Side by side mounting

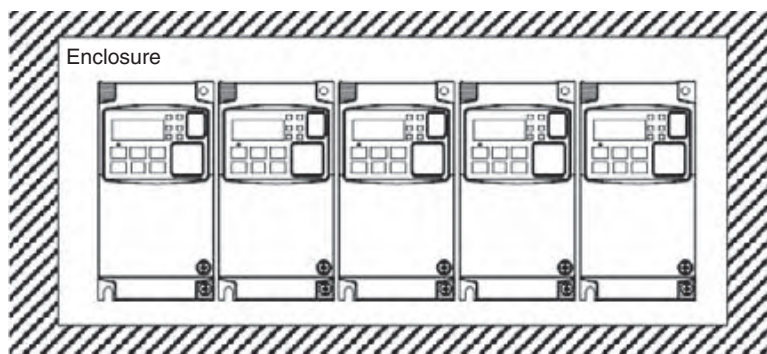

Inverter heat loss

Three-phase 200 V class

Model 3G3MX2		A2001	A2002	A2004	A2007	A2015	A2022	A2037	A2055	A2075	A2110	A2150
Inverter capacity kVA	200 VT	0.4	0.6	1.2	2.0	3.3	4.1	6.7	10.3	13.8	19.3	23.9
	200 CT	0.2	0.5	1.0	1.7	2.7	3.8	6.0	8.6	11.4	16.2	20.7
	240 VT	0.4	0.7	1.4	2.4	3.9	4.9	8.1	12.4	16.6	23.2	28.6
	240 CT	0.3	0.6	1.2	2.0	3.3	4.5	7.2	10.3	13.7	19.5	24.9
Rated current (A) VT		1.2	1.9	3.4	6.0	9.6	12.0	19.6	30.0	40.0	56.0	69.0
Rated current (A) CT		1.0	1.6	3.0	5.0	8.0	11.0	17.5	25.0	33.0	47.0	60.0
Total heat loss		12	22	30	48	79	104	154	229	313	458	625
Efficiency at rated load		89.5	90	93	94	95	95.5	96	96	96	96	96
Cooling Method		Self cooling					Forced-air-cooling					



Single-phase 200 V class 3G3MX2-AB

Model MX2		AB001	AB002	AB004	AB007	AB015	AB022
Inverter capacity kVA	200V VT	0.4	0.6	1.2	2.0	3.3	4.1
	200V CT	0.2	0.5	1.0	1.7	2.7	3.8
	240V VT	0.4	0.7	1.4	2.4	3.9	4.9
	240V CT	0.3	0.6	1.2	2.0	3.3	4.5
Rated current (A) VT		1.2	1.9	3.4	6.0	9.6	12.0
Rated current (A) CT		1.0	1.6	3.0	5.0	8.0	11.0
Total heat loss		12	22	30	48	79	104
Efficiency at rated load		89.5	90	93	94	95	95.5
Cooling Method		Self cooling			Forced-air-cooling		

Three-phase 400 V class 3G3MX2-A4

Model MX2		A4004	A4007	A4015	A4022	A4030	A4040	A4055	A4075	A4110	A4150
Inverter capacity kVA	380V VT	1.3	2.6	3.5	4.5	5.7	7.3	11.5	15.1	20.4	25.0
	380V CT	1.1	2.2	3.1	3.6	4.7	6.0	9.7	11.8	15.7	20.4
	480V VT	1.7	3.4	4.4	5.7	7.3	9.2	14.5	19.1	25.7	31.5
	480V CT	1.4	2.8	3.9	4.5	5.9	7.6	12.3	14.9	19.9	25.7
Rated current (A) VT		2.1	4.1	5.4	6.9	8.8	11.1	17.5	23.0	31.0	38.0
Rated current (A) CT		1.8	3.4	4.8	5.5	7.2	9.2	14.8	18.0	24.0	31.0
Total heat loss		35	56	96	116	125	167	229	296	411	528
Efficiency at rated load		92	93	94	95	96	96	96	96.2	96.4	96.6
Cooling Method		Self cooling			Forced-air-cooling						

Input AC Reactor 3G3AX-RAI

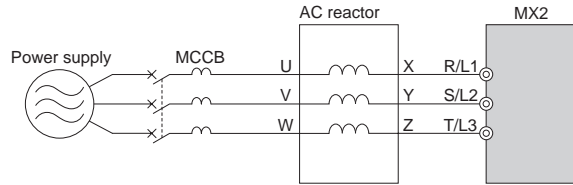

3 phase 200 V class				400 V class			
Max. applicable motor output kW	Reference	Current value A	Inductance mH	Max. applicable motor output kW	Reference	Current value A	Inductance mH
1.5	AX-RAI02800080-DE	8.0	2.8	1.5	AX-RAI07700050-DE	5.0	7.7
3.7	AX-RAI00880200-DE	20.0	0.88	4.0	AX-RAI03500100-DE	10.0	3.5
7.5	AX-RAI00350335-DE	33.5	0.35	7.5	AX-RAI01300170-DE	17.0	1.3
15	AX-RAI00180670-DE	67.0	0.18	15	AX-RAI00740335-DE	33.5	0.74

DC Reactor 3G3AX-RC



200 V class				400 V class			
Max. applicable motor output kW	Reference	Current value A	Inductance mH	Max. applicable motor output kW	Reference	Current value A	Inductance mH
0.2	AX-RC21400016-RE	1.6	21.4	0.4	AX-RC43000020-RE	2.0	43.0
0.4	AX-RC10700032-RE	3.2	10.7	0.7	AX-RC27000030-RE	3.0	27.0
0.7	AX-RC06750061-RE	6.1	6.75	1.5	AX-RC14000047-RE	4.7	14.0
1.5	AX-RC03510093-RE	9.3	3.51	2.2	AX-RC10100069-RE	6.9	10.1
2.2	AX-RC02510138-RE	13.8	2.51	3.0	AX-RC08250093-RE	9.3	8.25
3.7	AX-RC01600223-RE	22.3	1.60	4.0	AX-RC06400116-RE	11.6	6.40
5.5	AX-RC01110309-RE	30.9	1.11	5.5	AX-RC04410167-RE	16.7	4.41
7.5	AX-RC00840437-RE	43.7	0.84	7.5	AX-RC03350219-RE	21.9	3.35
11.0	AX-RC00590614-RE	61.4	0.59	11.0	AX-RC02330307-RE	30.7	2.33
15.0	AX-RC00440859-RE	85.9	0.44	15.0	AX-RC01750430-RE	43.0	1.75

Output AC Reactor 3G3AX-RAO

200 V class				400 V class			
Max. applicable motor output kW	Reference	Current value A	Inductance mH	Max. applicable motor output kW	Reference	Current value A	Inductance mH
0.4	AX-RAO11500026-DE	2.6	11.50	1.5	AX-RAO16300038-DE	3.8	16.30
0.75	AX-RAO07600042-DE	4.2	7.60				
1.5	AX-RAO04100075-DE	7.5	4.10				
2.2	AX-RAO03000105-DE	10.5	3.00	2.2	AX-RAO11800053-DE	5.3	11.80
3.7	AX-RAO01830160-DE	16.0	1.83	4.0	AX-RAO07300080-DE	8.0	7.30
5.5	AX-RAO01150220-DE	22.0	1.15	5.5	AX-RAO04600110-DE	11.0	4.60
7.5	AX-RAO00950320-DE	32.0	0.95	7.5	AX-RAO03600160-DE	16.0	3.60
11	AX-RAO00630430-DE	43.0	0.63	11	AX-RAO02500220-DE	22.0	2.50
15	AX-RAO00490640-DE	64.0	0.49	15	AX-RAO02000320-DE	32.0	2.00

Ordering information



3G3MX2

Voltage class	Specifications				Model
	Constant torque		Variable torque		Standard
	Max motor kW	Rated current A	Max motor kW	Rated current A	
Single-phase 200 V	0.1	1.0	0.2	1.2	3G3MX2-AB001-E
	0.2	1.6	0.4	1.9	3G3MX2-AB002-E
	0.4	3.0	0.55	3.5	3G3MX2-AB004-E
	0.75	5.0	1.1	6.0	3G3MX2-AB007-E
	1.5	8.0	2.2	9.6	3G3MX2-AB015-E
	2.2	11.0	3.0	12.0	3G3MX2-AB022-E
Three-phase 200 V	0.1	1.0	0.2	1.2	3G3MX2-A2001-E
	0.2	1.6	0.4	1.9	3G3MX2-A2002-E
	0.4	3.0	0.55	3.5	3G3MX2-A2004-E
	0.75	5.0	1.1	6.0	3G3MX2-A2007-E
	1.5	8.0	2.2	9.6	3G3MX2-A2015-E
	2.2	11.0	3.0	12.0	3G3MX2-A2022-E
	3.7	17.5	5.5	19.6	3G3MX2-A2037-E
	5.5	25.0	7.5	30.0	3G3MX2-A2055-E
	7.5	33.0	11	40.0	3G3MX2-A2075-E
	15	60.0	18.5	69.0	3G3MX2-A2150-E
Three-phase 400 V	0.4	1.8	0.75	2.1	3G3MX2-A4004-E
	0.75	3.4	1.5	4.1	3G3MX2-A4007-E
	1.5	4.8	2.2	5.4	3G3MX2-A4015-E
	2.2	5.5	3.0	6.9	3G3MX2-A4022-E
	3.0	7.2	4.0	8.8	3G3MX2-A4030-E
	4.0	9.2	5.5	11.1	3G3MX2-A4040-E
	5.5	14.8	7.5	17.5	3G3MX2-A4055-E
	7.5	18.0	11	23.0	3G3MX2-A4075-E
	11	24.0	15	31.0	3G3MX2-A4110-E
	15	31.0	18.5	38.0	3G3MX2-A4150-E

① Line filters

Inverter		Line filter Rasmi	
Voltage	Model MX2-□	Reference	Rated current (A)
1-Phase 200 VAC	AB001 / AB002 / AB004	AX-FIM1010-RE	10
	AB007	AX-FIM1014-RE	14
	AB015 / AB022	AX-FIM1024-RE	24
3-Phase 200 VAC	A2001 / A2002 / A2004 / A2007	AX-FIM2010-RE	10
	A2015 / A2022	AX-FIM2020-RE	20
	A2037	AX-FIM2030-RE	30
	A2055 / A2075	AX-FIM2060-RE	60
	A2110	AX-FIM2080-RE	80
3-Phase 400 VAC	A2150	AX-FIM2100-RE	100
	A4004 / A4007	AX-FIM3005-RE	5
	A4015 / A4022 / A4030	AX-FIM3010-RE	10
	A4040	AX-FIM3014-RE	14
3-Phase 400 VAC	A4055 / A4075	AX-FIM3030-RE	23
	A4110 / A4150	AX-FIM3050-RE	50

① Input AC Reactors

Inverter		AC Reactor
Voltage	Model MX2-□	Reference
3-Phase 200 VAC	A2002 / A2004 / A2007	AX-RAI02800080-DE
	A2015 / A2022 / A2037	AX-RAI00880200-DE
	A2055 / A2075	AX-RAI00350335-DE
	A2110 / A2150	AX-RAI00180670-DE
1-Phase 200 VAC	AB002 / AB004	Under development
	AB007	
	AB015 / AB022	
3-Phase 400 VAC	A4004 / A4007 / A4015	AX-RAI07700050-DE
	A4022 / A4030 / A4040	AX-RAI03500100-DE
	A4055 / A4075	AX-RAI01300170-DE
	A4110 / A4150	AX-RAI00740335-DE

① DC Reactors

200V single phase		200V 3-phase		400V 3-phase	
Inverter	DC Reactor	Inverter	DC Reactor	Inverter	DC Reactor
MX2-AB001	AX-RC10700032-RE	MX2-A2001	AX-RC21400016-RE	MX2-A4004	AX-RC43000020-RE
MX2-AB002		MX2-A2002		MX2-A4007	AX-RC27000030-RE
MX2-AB004	AX-RC06750061-RE	MX2-A2004	AX-RC10700032-RE	MX2-A4015	AX-RC14000047-RE
MX2-AB007	AX-RC03510093-RE	MX2-A2007	AX-RC06750061-RE	MX2-A4022	AX-RC10100069-RE
MX2-AB015	AX-RC02510138-RE	MX2-A2015	AX-RC03510093-RE	MX2-A4030	AX-RC08250093-RE
MX2-AB022	AX-RC01600223-RE	MX2-A2022	AX-RC02510138-RE	MX2-A4040	AX-RC06400116-RE
		MX2-A2037	AX-RC01600223-RE	MX2-A4055	AX-RC04410167-RE
		MX2-A2055	AX-RC01110309-RE	MX2-A4075	AX-RC03350219-RE
		MX2-A2075	AX-RC00840437-RE	MX2-A4011	AX-RC02330307-RE
		MX2-A2011	AX-RC00590614-RE	MX2-A4015	AX-RC01750430-RE
		MX2-A2015	AX-RC00440859-RE		-

① Chokes

Model	Diameter	Description
AX-FEJ2102-RE	21	For 2.2 KW motors or below
AX-FEJ2515-RE	25	For 15 KW motors or below
AX-FEJ5045-RE	50	For 45 KW motors or below

① Output AC Reactor

Inverter		AC Reactor
Voltage	Model MX2-□	Reference
200 VAC	A2001 / A2002 / A2004 AB001 / AB002 / AB004	AX-RAO11500026-DE
	A2007/AB007	AX-RAO07600042-DE
	A2015 / AB015	AX-RAO04100075-DE
	A2022 / AB022	AX-RAO03000105-DE
	A2037	AX-RAO01830160-DE
	A2055	AX-RAO01150220-DE
400 VAC	A2075	AX-RAO00950320-DE
	A4004 / A4007 / A4015	AX-RAO16300038-DE
	A4022	AX-RAO11800053-DE
	A4030 / A4040	AX-RAO07300080-DE
	A4055	AX-RAO04600110-DE
A4075	AX-RAO03600160-DE	

② Accessories

Types	Model	Description	Functions
Digital operator	3G3AX-OP05	LCD remote operator	5 Line LCD remote operator with copy function, cable length max. 3m.
	3G3AX-CAJOP300-EE	Remote operator cable	3 meters cable for connecting remote operator
Accessories	AX-PCUSB-E	PC configuration cable	Mini USB to USB connector cable

③ Communication option boards

Types	Model	Description	Functions
Communication options	3G3AX-MX2-PRT	Profibus option card	Used for running or stopping the inverter, setting or referencing parameters, and monitoring output frequency, output current, or similar items through Profibus communications with the host controller.  Under development
	3G3AX-MX2-DRT	DeviceNet option card	
	3G3AX-MX2-ERT	EtherCAT option card	
	3G3AX-MX2-CRT	CompoNet option card	
	3G3AX-MX2-ML2	Mechatrolink-II option card	
	3G3AX-MX2-CORT	CanOpen option card	

④ Braking unit, braking resistor unit

Inverter				Braking resistor unit							
Voltage	Max. motor kW	Inverter MX2□		Connectable min. resistance Ω	Inverter mounted type (3 %ED, 10 sec max)		Braking torque %	Inverter mounted type (10%ED, 10 sec max)		Braking torque %	
		3-phase	1-phase		Type AX-	Resist Ω		Type AX-	Resist Ω		
200 V (single-/three-phase)	0.12	2001	B001	100	REM00K1400-IE	400	200	REM00K1400-IE	400	200	
	0.25	2002	B002		180	REM00K1200-IE	200	180	REM00K1200-IE	200	180
	0.55	2004	B004		100			100	REM00K2070-IE	70	200
	1.1	2007	B007	50	REM00K2070-IE	70	140	REM00K4075-IE	75	130	
	1.5	2015	B015				90	REM00K4035-IE	35	180	
	2.2	2022	B022	35	REM00K4075-IE	75	50	REM00K6035-IE	35	100	
	4.0	2037	-				75	REM00K9017-IE	17	150	
	5.5	2055	-	20	REM00K4035-IE	35	55	REM01K9017-IE	17	110	
	7.5	2075	-				40	REM02K1017-IE	17	75	
	11	2110	-	17	REM00K6035-IE	35	40	REM02K1017-IE	17	75	
15	2150	-	10	REM00K9017-IE	17	55	REM03K5010-IE	10	95		
400 V (three-phase)	0.55	4004	-	180	REM00K1400-IE	400	200	REM00K1400-IE	400	200	
	1.1	4007	-		200	REM00K1200-IE	200	190	REM00K2200-IE	200	190
	1.5	4015	-		130			REM00K2200-IE	200	160	REM00K5120-IE
	2.2	4022	-	100	REM00K2120-IE	120	120			REM00K6100-IE	100
	3.0	4030	-				70	REM00K4075-IE	75	140	REM00K9070-IE
	4.0	4040	-	100	REM01K9070-IE	70				110	
	5.5	4055	-	70	REM00K6100-IE	100	50	REM02K1070-IE	70	75	
	7.5	4075	-				70	REM02K1070-IE	70	75	
	11	4110	-	35	REM00K9070-IE	70	55	REM03K5035-IE	35	110	
	15	4150	-				55	REM03K5035-IE	35	110	

⑤ Computer software

Types	Model	Description	Installation
Software	CX-Drive	Computer software	Configuration and monitoring software tool
	CX-One	Computer software	Configuration and monitoring software tool

ALL DIMENSIONS SHOWN ARE IN MILLIMETERS.  
To convert millimeters into inches, multiply by 0.03937. To convert grams into ounces, multiply by 0.03527.

# OMRON

**OMRON ELECTRONICS LLC • THE AMERICAS HEADQUARTERS**

**OMRON CANADA, INC. • HEAD OFFICE**

**OMRON ARGENTINA • SALES OFFICE**

**OMRON ELETRÔNICA DO BRASIL LTDA • HEAD OFFICE**

**OMRON CHILE • SALES OFFICE**

**OMRON ELECTRONICS MEXICO SA DE CV • HEAD OFFICE**

**OTHER OMRON LATIN AMERICA SALES**

Компания «Океан Электроники» предлагает заключение долгосрочных отношений при поставках импортных электронных компонентов на взаимовыгодных условиях!

Наши преимущества:

- Поставка оригинальных импортных электронных компонентов напрямую с производств Америки, Европы и Азии, а так же с крупнейших складов мира;
- Широкая линейка поставок активных и пассивных импортных электронных компонентов (более 30 млн. наименований);
- Поставка сложных, дефицитных, либо снятых с производства позиций;
- Оперативные сроки поставки под заказ (от 5 рабочих дней);
- Экспресс доставка в любую точку России;
- Помощь Конструкторского Отдела и консультации квалифицированных инженеров;
- Техническая поддержка проекта, помощь в подборе аналогов, поставка прототипов;
- Поставка электронных компонентов под контролем ВП;
- Система менеджмента качества сертифицирована по Международному стандарту ISO 9001;
- При необходимости вся продукция военного и аэрокосмического назначения проходит испытания и сертификацию в лаборатории (по согласованию с заказчиком);
- Поставка специализированных компонентов военного и аэрокосмического уровня качества (Xilinx, Altera, Analog Devices, Intersil, Interpoint, Microsemi, Actel, Aeroflex, Peregrine, VPT, Syfer, Eurofarad, Texas Instruments, MS Kennedy, Miteq, Cobham, E2V, MA-COM, Hittite, Mini-Circuits, General Dynamics и др.);

Компания «Океан Электроники» является официальным дистрибьютором и эксклюзивным представителем в России одного из крупнейших производителей разъемов военного и аэрокосмического назначения «**JONHON**», а так же официальным дистрибьютором и эксклюзивным представителем в России производителя высокотехнологичных и надежных решений для передачи СВЧ сигналов «**FORSTAR**».



## JONHON

«**JONHON**» (основан в 1970 г.)

Разъемы специального, военного и аэрокосмического назначения:

(Применяются в военной, авиационной, аэрокосмической, морской, железнодорожной, горно- и нефтедобывающей отраслях промышленности)

«**FORSTAR**» (основан в 1998 г.)

ВЧ соединители, коаксиальные кабели, кабельные сборки и микроволновые компоненты:

(Применяются в телекоммуникациях гражданского и специального назначения, в средствах связи, РЛС, а так же военной, авиационной и аэрокосмической отраслях промышленности).



Телефон: 8 (812) 309-75-97 (многоканальный)

Факс: 8 (812) 320-03-32

Электронная почта: [ocean@oceanchips.ru](mailto:ocean@oceanchips.ru)

Web: <http://oceanchips.ru/>

Адрес: 198099, г. Санкт-Петербург, ул. Калинина, д. 2, корп. 4, лит. А