

SSL - Discrete Wire IDC



Series 9177



The 917X series of surface mount Insulation Displacement Connectors (IDC) were developed to meet the harsh automotive and industrial market applications for connecting individual wires directly to a PCB ranging from 14 AWG to 28 AWG. This industry proven contact system has been tested to automotive levels of shock, vibration, and temperature cycling to prove their reliability and robustness. The simplicity of inserting a wire into the connector with a small tool allows a wide range of devices to be connected to the PCB without soldering. In SSL applications specifically, these connectors are used to bring power and signal onto the PCB or are used to daisy chain multiple boards together in a long string. While the IDC contact provides a gas-tight connection to conductor of the wire, the housing has been designed to grab the insulation of the wire to provide a positive strain relief even in the harshest conditions. In case of repair, the wires can be removed and replace up to three times.

The 9177 series accepts 14 AWG to 20 AWG wires with an insulation diameter ranging from 2.75mm to 4.25mm. These dual contact connectors support a 15 amp current rating with two large SMT solder tails per wire to provide maximum stability on the PCB. Available in 1p-3p configuration, these connectors can be end stackable for higher pin counts.

APPLICATIONS

- Connecting discrete wire components directly to the PCB
- Bringing power and signals onto a PCB
- Daisy chaining PCB's together to create a continuous string of boards
- Application Notes: refer to 201-01-124

FEATURES AND BENEFITS

- IDC contact provides a gas-tight connection to the PCB for long term reliability
- Connector housing captures the wire insulation for positive strain relief
- Tested to automotive levels on shock, vibration and temperature cycling for reliability
- Low and high volume assembly tools to match production volumes
- Reduced total applied cost versus solder or crimp processes
- High temperature insulator capable to 260°C reflow soldering processes

ELECTRICAL

- Current Rating: 15 Amp / Contact
- Voltage Rating: 600 VAC

ENVIRONMENTAL

- Operating Temperature: -40°C to +125°C

MECHANICAL

- Insulator Material: Nylon 46: UL94V0
- Contact Material: Phosphor Bronze
- Plating: Tin over Nickel
- Durability: 3 Cycles

HOW TO ORDER

00
Prefix

9177
Series

00X
Number of Ways

Code	No of Ways	Details
001	1	Page 62
002	2	Page 63
003	3	Page 64

00X
Wire Gauge Size

Code	Accepted Wire Gauge	Wire Insulation
001	14 AWG	Ø 4.25
012	16 AWG	Ø 3.50
022	18 AWG	Ø 3.50
033	20 AWG	Ø 2.75

X
Insulator Color

Code	Color	Application
0	Black	Industrial
1	White	Lighting

06
Plating Option
06 = Pure Tin all over

Certification: UL File #E320991



SSL - Discrete Wire IDC



Series 9177

14-20 AWG 1 WAY IDC CONNECTOR



NOTES:

1. CONNECTOR FOR IDC WIRE TO BOARD CONNECTION.
2. CONTACT MATERIAL: PHOSPHORE BRONZE.
INSULATION MATERIAL: HIGH TEMPERATURE NYLON 46.
COLOR REFER TO PAGE 61.
3. CONNECTOR DESIGNED TO ACCEPT BETWEEN 14 AND 20 GAUGE STRANDED WIRE.
4. ALL DIMENSIONS FOR REFERENCE UNLESS OTHERWISE STATED.
5. FOR FULL PRODUCT SPECIFICATION REFER TO ELCO SPEC 201-01-109.
6. FOR PCB SPACE RESTRICTED BY ASSEMBLY TOOLING REFER TO PAGE 65.



Code	Accepted Wire Gauge	A	Wire Insulation	B
001	14 Gauge Stranded	1.10	Ø 4.25 max	4.25
012	16 Gauge Stranded	0.82	Ø 3.50 max	3.50
022	18 Gauge Stranded	0.72	Ø 3.50 max	3.50
033	20 Gauge Stranded	0.60	Ø 2.75 max	2.75

SMT PCB LAYOUT

PURE TIN PADS



PACKING DETAILS

REEL QTY	400
LEADER	500MM
TRAILER	400MM
REEL/BOX	4
PACK QTY	1600

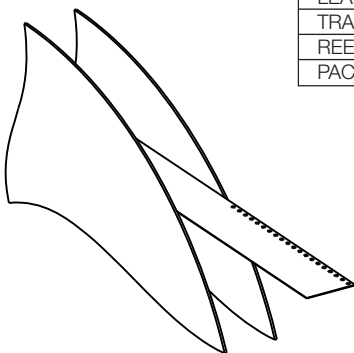

SSL - Discrete Wire IDC



Series 9177

14-20 AWG 2 WAY IDC CONNECTOR



NOTES:

- CONNECTOR FOR IDC WIRE TO BOARD CONNECTION.
- CONTACT MATERIAL: PHOSPHORE BRONZE.
INSULATION MATERIAL: HIGH TEMPERATURE NYLON 46.
COLOR REFER TO PAGE 61.
- CONNECTOR DESIGNED TO ACCEPT BETWEEN 14 AND 20 GAUGE STRANDED WIRE.
- ALL DIMENSIONS FOR REFERENCE UNLESS OTHERWISE STATED.
- FOR FULL PRODUCT SPECIFICATION REFER TO ELCO SPEC 201-01-109.
- FOR PCB SPACE RESTRICTED BY ASSEMBLY TOOLING REFER TO PAGE 65.



Code	Accepted Wire Gauge	A	Wire Insulation	B
001	14 Gauge Stranded	1.10	Ø 4.25 max	4.25
012	16 Gauge Stranded	0.82	Ø 3.50 max	3.50
022	18 Gauge Stranded	0.72	Ø 3.50 max	3.50
033	20 Gauge Stranded	0.60	Ø 2.75 max	2.75

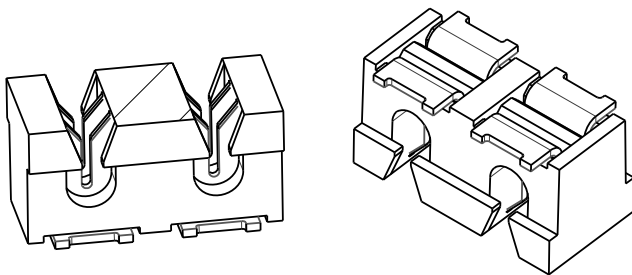

SMT PCB LAYOUT

PURE TIN PADS



PACKING DETAILS

REEL QTY	400
LEADER	500MM
TRAILER	400MM
REEL/BOX	4
PACK QTY	1600



SSL - Discrete Wire IDC



Series 9177

14-20 AWG 3 WAY IDC CONNECTOR



NOTES:

1. CONNECTOR FOR IDC WIRE TO BOARD CONNECTION.
2. CONTACT MATERIAL: PHOSPHORE BRONZE.
INSULATION MATERIAL: HIGH TEMPERATURE NYLON 46.
COLOR REFER TO PAGE 61.
3. CONNECTOR DESIGNED TO ACCEPT BETWEEN 14 AND 20 GAUGE STRANDED WIRE.
4. ALL DIMENSIONS FOR REFERENCE UNLESS OTHERWISE STATED.
5. FOR FULL PRODUCT SPECIFICATION REFER TO ELCO SPEC 201-01-109.
6. FOR PCB SPACE RESTRICTED BY ASSEMBLY TOOLING REFER TO PAGE 65.



PICK UP AREA 4.75 x 9.00mm MIN



Code	Accepted Wire Gauge	A	Wire Insulation	B
001	14 Gauge Stranded	1.10	Ø 4.25 max	4.25
012	16 Gauge Stranded	0.82	Ø 3.50 max	3.50
022	18 Gauge Stranded	0.72	Ø 3.50 max	3.50
033	20 Gauge Stranded	0.60	Ø 2.75 max	2.75

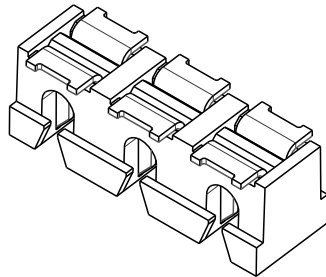

SMT PCB LAYOUT

PURE TIN PADS



PACKING DETAILS

REEL QTY	400
LEADER	500MM
TRAILER	400MM
REEL/BOX	4
PACK QTY	1600



SSL - Discrete Wire IDC



Series 9177

INSERTION TOOLING – REQUIRES HAND PRESS WITH FLAT ROCK PLATES

1 WAY



2 WAY

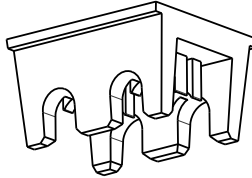

3 WAY

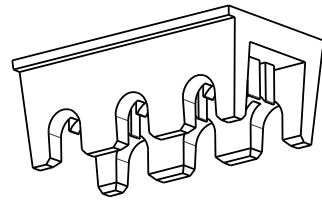

HIGH PRODUCTION

No. of Ways	Max Insulation Dia (AWG)	Tool Part Number
1	4.25 (14)	06 9177 7017 01 001
	3.50 (16-18)	06 9177 7017 02 001
	2.75 (20)	06 9177 7017 03 001
2	4.25 (14)	06 9177 7017 01 002
	3.50 (16-18)	06 9177 7017 02 002
	2.75 (20)	06 9177 7017 03 002
3	4.25 (14)	06 9177 7017 01 003
	3.50 (16-18)	06 9177 7017 02 003
	2.75 (20)	06 9177 7017 03 003

MEDIUM PRODUCTION Plastic

No. of Ways	Max Insulation Dia (AWG)	Tool Part Number
1	4.25 (14)	06 9177 7016 01 001
	3.50 (16-18)	06 9177 7016 02 001
	2.75 (20)	06 9177 7016 03 001
2	4.25 (14)	06 9177 7016 01 002
	3.50 (16-18)	06 9177 7016 02 002
	2.75 (20)	06 9177 7016 03 002
3	4.25 (14)	06 9177 7016 01 003
	3.50 (16-18)	06 9177 7016 02 003
	2.75 (20)	06 9177 7016 03 003

The assembly tooling restricts the available space/component heights on the PCB. For details see below.

NOTES:

1. ALL DIMENSIONS FOR REFERENCE DIMENSIONS.
2. MAXIMUM COMPONENT HEIGHT 0.80MM IN THIS AREA.
3. MAXIMUM COMPONENT HEIGHT 11.00 MM IN THIS AREA.
4. THE SAME RESTRICTIONS APPLY TO ALL WIRE INSULATION DIAMETERS.

INSERTION TOOLING – PCB RESTRICTED AREAS FOR ASSEMBLY TOOLING

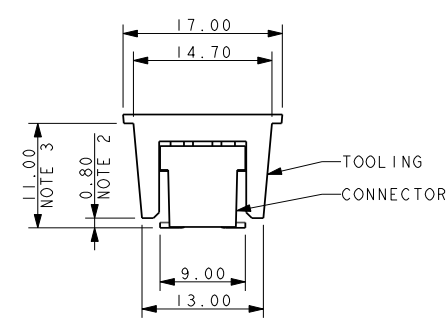

1 WAY

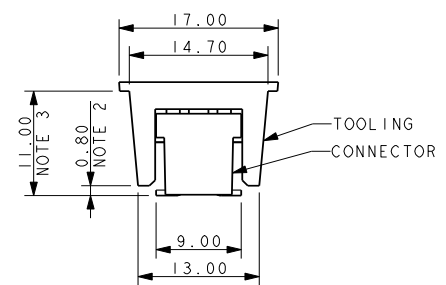
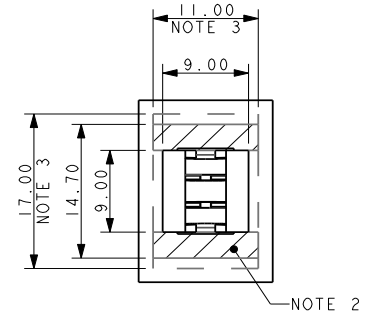
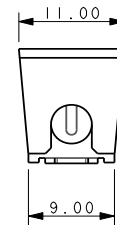

2 WAY

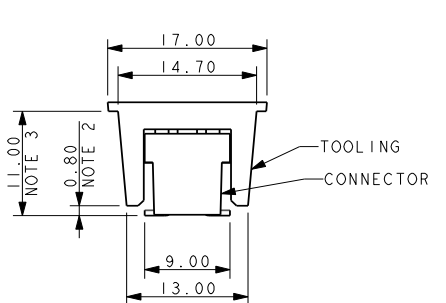
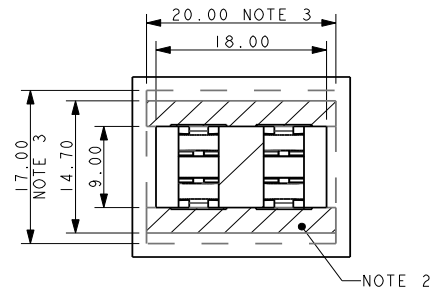
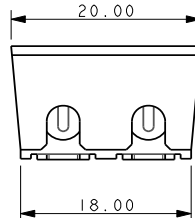

3 WAY

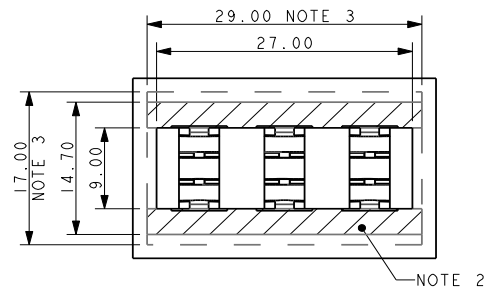
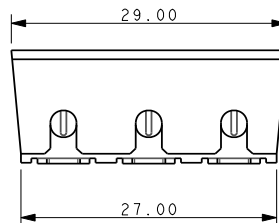

Компания «Океан Электроники» предлагает заключение долгосрочных отношений при поставках импортных электронных компонентов на взаимовыгодных условиях!

Наши преимущества:

- Поставка оригинальных импортных электронных компонентов напрямую с производств Америки, Европы и Азии, а так же с крупнейших складов мира;
- Широкая линейка поставок активных и пассивных импортных электронных компонентов (более 30 млн. наименований);
- Поставка сложных, дефицитных, либо снятых с производства позиций;
- Оперативные сроки поставки под заказ (от 5 рабочих дней);
- Экспресс доставка в любую точку России;
- Помощь Конструкторского Отдела и консультации квалифицированных инженеров;
- Техническая поддержка проекта, помощь в подборе аналогов, поставка прототипов;
- Поставка электронных компонентов под контролем ВП;
- Система менеджмента качества сертифицирована по Международному стандарту ISO 9001;
- При необходимости вся продукция военного и аэрокосмического назначения проходит испытания и сертификацию в лаборатории (по согласованию с заказчиком);
- Поставка специализированных компонентов военного и аэрокосмического уровня качества (Xilinx, Altera, Analog Devices, Intersil, Interpoint, Microsemi, Actel, Aeroflex, Peregrine, VPT, Syfer, Eurofarad, Texas Instruments, MS Kennedy, Miteq, Cobham, E2V, MA-COM, Hittite, Mini-Circuits, General Dynamics и др.);

Компания «Океан Электроники» является официальным дистрибьютором и эксклюзивным представителем в России одного из крупнейших производителей разъемов военного и аэрокосмического назначения «JONHON», а так же официальным дистрибьютором и эксклюзивным представителем в России производителя высокотехнологичных и надежных решений для передачи СВЧ сигналов «FORSTAR».



JONHON

«JONHON» (основан в 1970 г.)

Разъемы специального, военного и аэрокосмического назначения:

(Применяются в военной, авиационной, аэрокосмической, морской, железнодорожной, горно- и нефтедобывающей отраслях промышленности)

«FORSTAR» (основан в 1998 г.)

ВЧ соединители, коаксиальные кабели, кабельные сборки и микроволновые компоненты:

(Применяются в телекоммуникациях гражданского и специального назначения, в средствах связи, РЛС, а так же военной, авиационной и аэрокосмической отраслях промышленности).



Телефон: 8 (812) 309-75-97 (многоканальный)

Факс: 8 (812) 320-03-32

Электронная почта: ocean@oceanchips.ru

Web: <http://oceanchips.ru/>

Адрес: 198099, г. Санкт-Петербург, ул. Калинина, д. 2, корп. 4, лит. А