

# 18000 series

Snap-action momentary pushbutton switches



## DISTINCTIVE FEATURES

Panel and PC mount models  
Snap-in panel mounting version  
Tactile feedback



## ELECTRICAL SPECIFICATIONS

- Max. current/voltage rating with resistive load :
  - gold plated brass contacts : 100 mA - 30 VDC
  - gold plated silver contacts : 1 A 30 VDC
- Initial contact resistance : 50 mΩ max.
- Insulation resistance : 1,000 MΩ min.
- Dielectric strength : 1,000 Vrms 50 Hz min.
- Electrical life : 60,000 cycles at full load



## GENERAL SPECIFICATIONS

- Total travel : 0.5 mm (.019)
- Torque : 1.25 Nm (.922 Ft.lb) max. applied to nut
- Operating temperature : -30 °C to +65 °C (-22 °F to +149 °F)
- Soldering : 300 °C (572 °F), 3 sec. max.



## MATERIALS

- Case : PBT
- Actuator : polyamide, glass filled
- Bushing : brass, nickel plated
- Housing : stainless steel
- Bracket : tin plated steel
- Contacts
  - AD : silver, gold plated
  - CD : brass, gold plated
- Terminal seal : epoxy

APEM products may be recycled at end-of-life for the re-claiming of valuable metal components.

The company reserves the right to change specifications without notice.



# 18000 series

Snap-action momentary pushbutton switches



## TERMINALS



## ELECTRICAL FUNCTION

→ KEYWAY

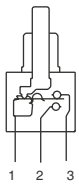

Plain bushing

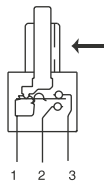

Threaded bushing



## PANEL CUT-OUT

18500 - 18200

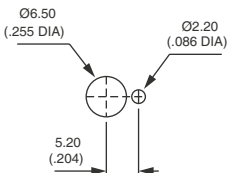

18700 - 18900

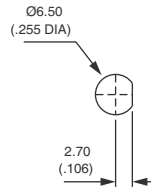

18800



With bezel U1200

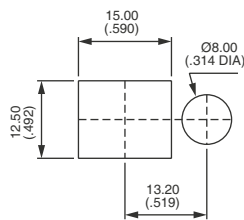

With bezel U1210 for LED

# 18000 series

Snap-action momentary pushbutton switches



## BUILD YOUR PART NUMBER



## ABOUT THIS SERIES

On the following pages, you will find successively basic part numbers of switches and options in the same order as in above chart.

- ⚠ **Notice** : please note that not all combinations of above numbers are available. Refer to following pages for further information.
- 🔒 **Sealing boots** are available to protect the switches against dust and water. See "Sealing Boots" section on website.
- 🔧 **Mounting accessories** : standard hardware supplied with all models with Ø 6,35 (1/4) threaded bushing : 2 hex nuts 8 mm (.314) across flats, 1 locking ring and 1 lockwasher. Standard and special hardware is presented in the "Hardware" section of website.

# 18000 series

Snap-action momentary pushbutton switches

## THREADED BUSHING SOLDER LUG TERMINALS : 18500



Single pole	1-3	1-2
<b>18535</b>	ON	MOM
Double pole	ON	MOM
<b>18545</b>		



→ KEYWAY

Shown with standard plunger

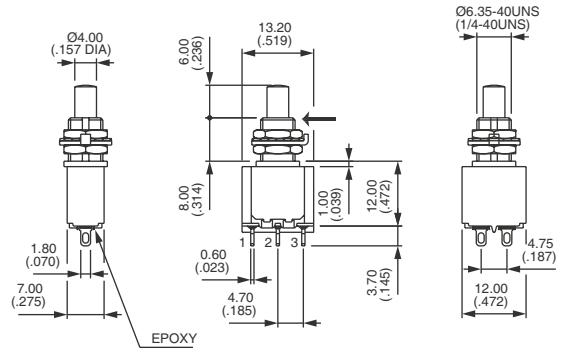

## FLATTED BUSHING SOLDER LUG TERMINALS : 18700



Single pole	1-3	1-2
<b>18735</b>	ON	MOM
Double pole	ON	MOM
<b>18745</b>		



→ KEYWAY

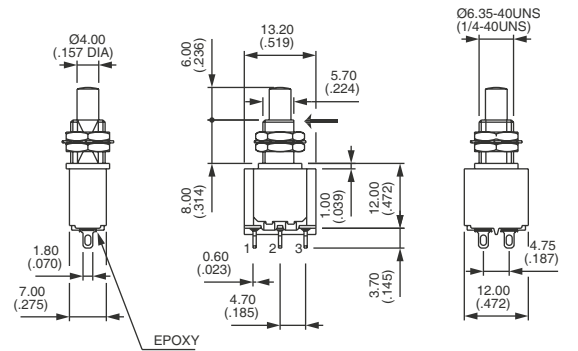

## THREADED BUSHING STRAIGHT PC TERMINALS : 18200



Single pole	1-3	1-2
<b>18235</b>	ON	MOM
Double pole	ON	MOM
<b>18245</b>		



→ KEYWAY

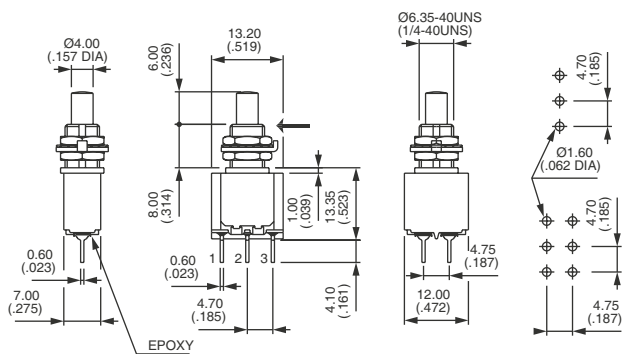

## FLATTED BUSHING - STRAIGHT PC TERMINALS : 18900



Single pole	1-3	1-2
<b>18935</b>	ON	MOM
Double pole	ON	MOM
<b>18945</b>		



→ KEYWAY

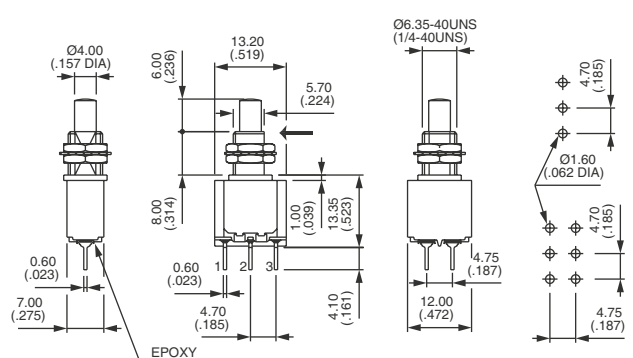

# 18000 series

Snap-action momentary pushbutton switches

## SNAP-IN MOUNTING SOLDER LUG TERMINALS : 18800



Single pole

18835



1-3

ON



1-2

MOM

Double pole

18845

ON

MOM

Available with straight PC terminals : see X662 under "Special options"

## STRAIGHT PC TERMINALS BRACKET MOUNTING - SINGLE POLE : 18230Y



18235Y



ON



MOM

## STRAIGHT PC TERMINALS BRACKET MOUNTING - DOUBLE POLE : 18240Y



18245Y



ON



MOM

## RIGHT ANGLE TERMINALS HORIZONTAL : 18200W



Single pole

18235W



ON



MOM

Double pole

18245W

ON

MOM

Shown with cap U910 + U1200

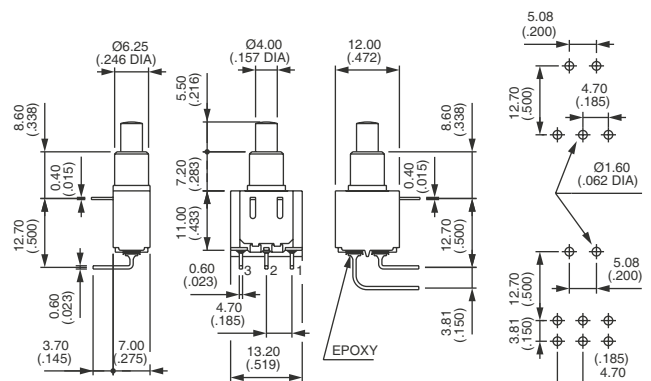
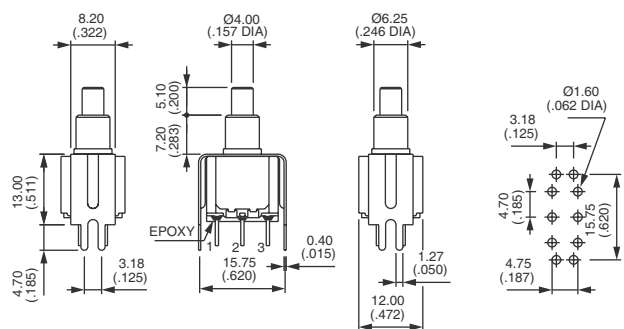

# 18000 series

Snap-action momentary pushbutton switches

## PLAIN BUSHING - RIGHT ANGLE TERMINALS VERTICAL : 18200WW



Single pole

**18235WW**

Double pole

**18245WW**



1-3  
ON



1-2  
MOM

ON

MOM

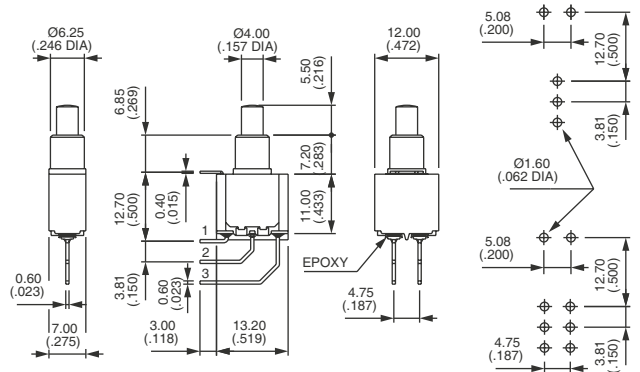

### CONTACT MATERIALS



- AD Silver, gold plated
- CD Brass, gold plated

### PLUNGERS



Dash compulsory before plunger code.

- Blank Ø 4 (.157) - long
- 6 Ø 3.1 (.122)
- 3 Ø 4 (.157) - short
- 5 Ø 3.1 (.122)

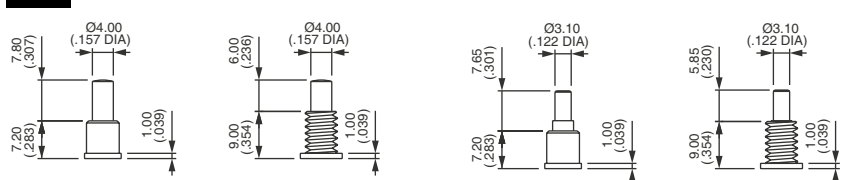

Blank

-6

-3

-5

### SPECIAL OPTIONS



- X371 Plain bushing Ø 6.25 mm (.246) (instead of standard threaded bushing).
- X372 Shorter threaded bushing Ø 6.35 (1/4).  
Height 7 mm (.274).

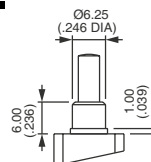

X371

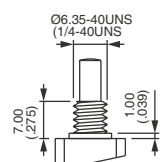

X372

# 18000 series

Snap-action momentary pushbutton switches

## SPECIAL OPTIONS (CONTINUED)



- X386** Threaded bushing  $\varnothing$  6.35 mm (1/4) to replace plain bushing on models W - WW and Y.
- X438** Plain bushing  $\varnothing$  6.25 mm (.246). **Height 7,2 mm (.283) - without shoulder.**
- X624** Straight PC terminals - bracket mounting - with shorter bushing and plunger
- X662** Snap-in mounting - straight PC terminals



### OPTION X624 - SINGLE POLE



18235Y -2X624



ON



MOM



### OPTION X624 - DOUBLE POLE



18245Y -2X624



ON



MOM



### OPTION X662



# 18000 series

Snap-action momentary pushbutton switches

CAPS



For cap colors, replace last "0" by number :

- |     |           |     |        |
|-----|-----------|-----|--------|
| 1   | Blue      | 5   | Yellow |
| 1/4 | Dark blue | 6   | Red    |
| 2   | Black     | 7   | Ivory  |
| 3   | Green     | 7/1 | White  |
| 4   | Grey      | 9   | Orange |

CAPS FOR Ø 4 (.157) PLUNGERS (-13, -3)

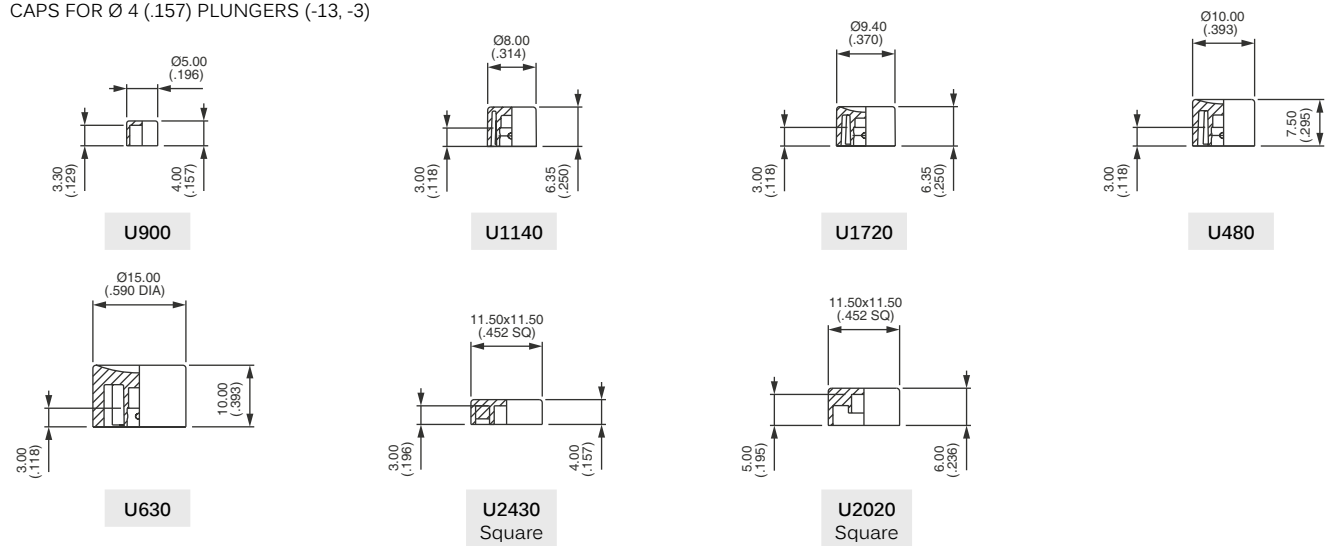

CAPS FOR Ø 3.1 (.122) PLUNGERS (-5, -6)

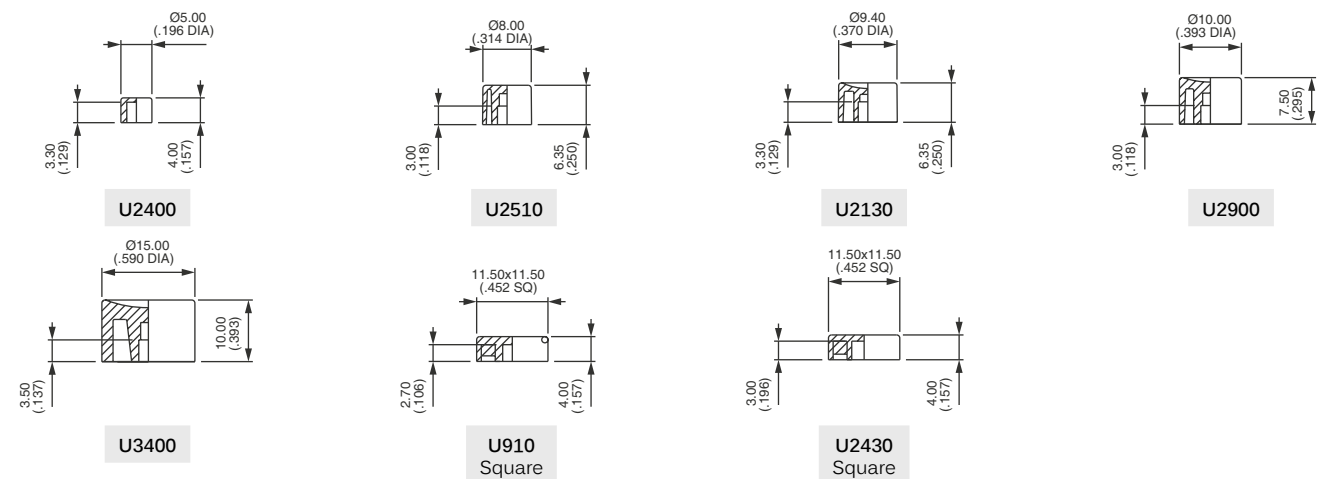

CAPS FOR Ø 3.1 (.122) PLUNGERS (-5, -6)

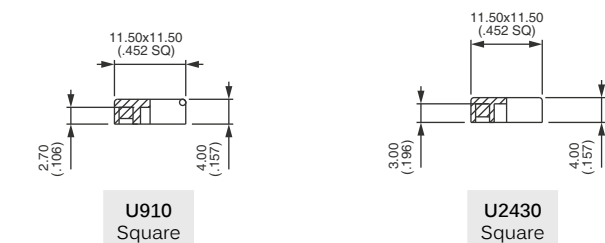



# 18000 series

Snap-action momentary pushbutton switches

## BEZELS



For cap colors, replace last "0" by number :

- |     |           |     |        |
|-----|-----------|-----|--------|
| 1   | Blue      | 5   | Yellow |
| 1/4 | Dark blue | 6   | Red    |
| 2   | Black     | 7   | Ivory  |
| 3   | Green     | 7/1 | White  |
| 4   | Grey      | 9   | Orange |

### STANDARD PANEL MOUNTING

Panel thickness with bezel : 1 mm (.039) to 2.5 mm (.098)



18800 + U910 + U1200

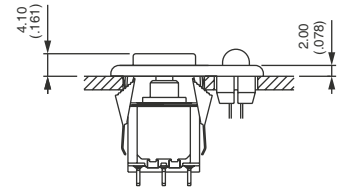

18800 + U910 + U1210

FOR BRACKET MOUNTING MODELS (18200Y & 18200YX624)



U3200

FOR SNAP-IN MODELS (18800 - 18800X662)

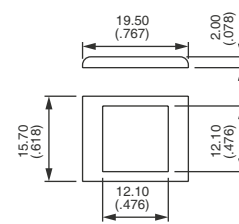

U1200



U1210  
For LED Ø 5 - not supplied

## DRESS NUTS

Order separately. For models with threaded bushing (18500 - 18700 - 18200 - 18900)  
Chrome plated.

- U1636 For caps U1140 and U2510
- U840 For cap U480 and U2900
- U825 For caps U630 and U3400



U1636



U840

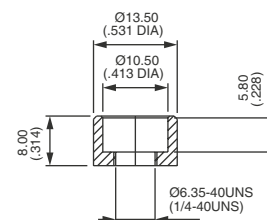

U825

# 18000 series

Snap-action momentary pushbutton switches •  
high currents



## DISTINCTIVE FEATURES

Tactile feedback  
High currents



## ELECTRICAL SPECIFICATIONS

- Max. current/voltage rating with resistive load : 7 A 30 VDC
- Initial contact resistance : 20 mΩ max. at 0.1 A 3 VDC
- Insulation resistance : 200,000 MΩ min. between terminals and frame
- Dielectric strength : 1,500 Vrms 50 Hz min.
- Electrical life : 60,000 cycles at full load



## GENERAL SPECIFICATIONS

- Total travel : 0.9 mm (.035) approx.
- Operating temperature : -30 °C to +65 °C (-22 °F to +149 °F)



## MATERIALS

- Case : diallyphthalate (DAP)
- Actuator : glass filled polyester
- Bushing : brass, nickel plated
- Housing : stainless steel
- Contacts : silver
- Terminal seal : epoxy

APEM products may be recycled at end-of-life for the re-claiming of valuable metal components.



## ELECTRICAL FUNCTION

→ KEYWAY

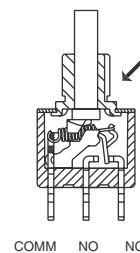

## PANEL CUT-OUT

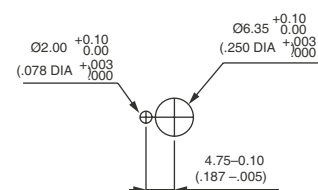

# 18000 series

Snap-action momentary pushbutton switches • high currents

## THREADED BUSHING - SINGLE POLE



18635A



ON



MOM

→ KEYWAY

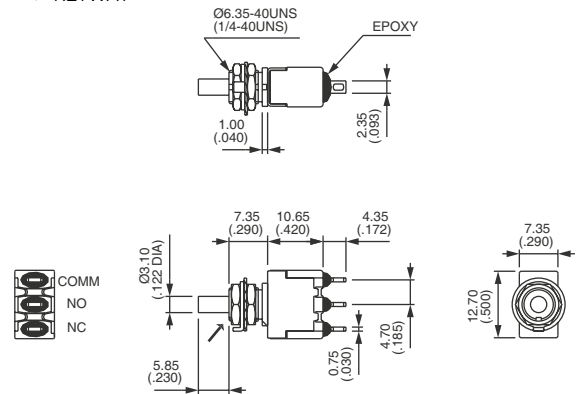

Also available in double pole configuration.

## CAPS

BASIC P/N

+ U...

### ROUND

- U2400 Ø 5 (.196)
- U2510 Ø 8 (.314)
- U2130 Ø 9,4 (.370)
- U2900 Ø 10 (.393)
- U3400 Ø 15 (.590)

### SQUARE

- U910 Height 4 (.157)
- U2340 Height 6 (.236)

For cap dimensions, see "Caps for Ø 3,1 (.122) plungers" on the preceding pages.

Компания «Океан Электроники» предлагает заключение долгосрочных отношений при поставках импортных электронных компонентов на взаимовыгодных условиях!

Наши преимущества:

- Поставка оригинальных импортных электронных компонентов напрямую с производств Америки, Европы и Азии, а так же с крупнейших складов мира;
- Широкая линейка поставок активных и пассивных импортных электронных компонентов (более 30 млн. наименований);
- Поставка сложных, дефицитных, либо снятых с производства позиций;
- Оперативные сроки поставки под заказ (от 5 рабочих дней);
- Экспресс доставка в любую точку России;
- Помощь Конструкторского Отдела и консультации квалифицированных инженеров;
- Техническая поддержка проекта, помощь в подборе аналогов, поставка прототипов;
- Поставка электронных компонентов под контролем ВП;
- Система менеджмента качества сертифицирована по Международному стандарту ISO 9001;
- При необходимости вся продукция военного и аэрокосмического назначения проходит испытания и сертификацию в лаборатории (по согласованию с заказчиком);
- Поставка специализированных компонентов военного и аэрокосмического уровня качества (Xilinx, Altera, Analog Devices, Intersil, Interpoint, Microsemi, Actel, Aeroflex, Peregrine, VPT, Syfer, Eurofarad, Texas Instruments, MS Kennedy, Miteq, Cobham, E2V, MA-COM, Hittite, Mini-Circuits, General Dynamics и др.);

Компания «Океан Электроники» является официальным дистрибьютором и эксклюзивным представителем в России одного из крупнейших производителей разъемов военного и аэрокосмического назначения «JONHON», а так же официальным дистрибьютором и эксклюзивным представителем в России производителя высокотехнологичных и надежных решений для передачи СВЧ сигналов «FORSTAR».



## JONHON

«JONHON» (основан в 1970 г.)

Разъемы специального, военного и аэрокосмического назначения:

(Применяются в военной, авиационной, аэрокосмической, морской, железнодорожной, горно- и нефтедобывающей отраслях промышленности)

«FORSTAR» (основан в 1998 г.)

ВЧ соединители, коаксиальные кабели,  
кабельные сборки и микроволновые компоненты:

(Применяются в телекоммуникациях гражданского и специального назначения, в средствах связи, РЛС, а так же военной, авиационной и аэрокосмической отраслях промышленности).



Телефон: 8 (812) 309-75-97 (многоканальный)

Факс: 8 (812) 320-03-32

Электронная почта: [ocean@oceanchips.ru](mailto:ocean@oceanchips.ru)

Web: <http://oceanchips.ru/>

Адрес: 198099, г. Санкт-Петербург, ул. Калинина, д. 2, корп. 4, лит. А