

Click [here](#) for production status of specific part numbers.

MAXM17575

4.5V to 60V, 1.5A High-Efficiency, DC-DC Step-Down Power Module with Integrated Inductor

General Description

The *Himalaya* series of voltage regulator ICs and power modules enable cooler, smaller, and simpler power supply solutions. The MAXM17575 is an easy-to-use power module that combines a synchronous step-down DC-DC converter, a fully shielded inductor, and compensation components into a low-profile, thermally-efficient, system-in-package (SiP). The device operates over a wide input-voltage range of 4.5V to 60V, delivers up to 1.5A continuous output current and has excellent line and load regulation over an output-voltage range of 0.9V to 12V. The high level of integration significantly reduces design complexity, manufacturing risks, and offers a true plug-and-play power-supply solution, reducing time-to-market.

The MAXM17575 offers resistor-programmable switching frequency, $\overline{\text{RESET}}$ output-voltage monitoring, adjustable input undervoltage lockout, and programmable soft-start. The device also features hiccup-mode overload protection, and thermal shutdown function.

The MAXM17575 is available in a low-profile, highly thermal-emissive, compact, 28-pin 6.5mm × 10mm × 2.92mm SiP package, which reduces power dissipation and enhances efficiency. The package is easily soldered onto a printed circuit board and is suitable for automated circuit board assembly. The device can operate over the industrial temperature range from -40°C to +125°C.

Applications

- Industrial Power Supplies
- Distributed Supply Regulation
- FPGA and DSP Point-of-Load Regulator
- Base Station Point-of-Load Regulator
- HVAC and Building Control

[Ordering Information](#) appears at end of data sheet.

Benefits and Features

- Reduces Design Complexity, Manufacturing Risks, and Time-to-Market
 - Integrated Step-Down DC-DC Converter
 - Integrated Inductor
 - Integrated Compensation Components
- Saves Board Space in Space-Constrained Applications
 - Complete Integrated Step-Down Power Supply in a Single Package
 - Small Profile 6.5mm × 10mm × 2.92mm SiP Package
 - Simplified PCB Design with Minimal External BOM Components
- Offers Flexibility for Power-Design Optimization
 - Wide Input-Voltage Range from 4.5V to 60V
 - Output-Voltage Adjustable Range from 0.9V to 12V
 - Adjustable Frequency with External Frequency Synchronization (400kHz to 2.2MHz)
 - Soft-Start Programmable
 - PWM Mode of Operation
 - Optional Programmable EN/UVLO
- Operates Reliably in Adverse Industrial Environments
 - Integrated Thermal Fault Protection
 - Hiccup Mode Overload Protection
 - $\overline{\text{RESET}}$ Output-Voltage Monitoring
 - High Industrial Ambient Operating Temperature Range (-40°C to +125°C) / Junction Temperature Range (-40°C to +150°C)
 - Complies with CISPR22(EN55022) Class B Conducted and Radiated Emissions

Typical Application Circuit

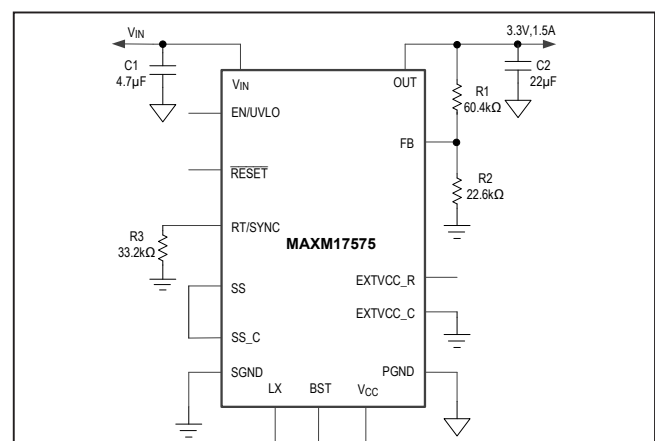

Absolute Maximum Ratings

V _{IN} to PGND	-0.3V to +65V	FB to SGND	-0.3V to 1.5V
EN/UVLO to SGND	-0.3V to (V _{IN} + 0.3V)	RT/SYNC, SS, $\overline{\text{RESET}}$, V _{CC} , SS_C to SGND	-0.3V to +6.5V
EXTVCC_C to SGND	-0.3V to +26V	PGND to SGND	-0.3V to +0.3V
BST to PGND	-0.3V to +70V	Output Short-Circuit Duration	Continuous
BST to LX	-0.3V to +6.0V	Operating Temperature Range (Note 1)	-40°C to +125°C
BST to V _{CC}	-0.3V to +65V	Junction Temperature	+150°C
LX, EXTVCC_R, OUT to		Storage Temperature Range	-40°C to +150°C
PGND (V _{IN} < 25 V)	-0.3V to (V _{IN} + 0.3V)	Soldering Temperature (reflow)	+260°C
LX, EXTVCC_R, OUT to PGND (V _{IN} > 25V)	-0.3V to +25V	Lead Temperature (soldering, 10s)	+300°C

Stresses beyond those listed under "Absolute Maximum Ratings" may cause permanent damage to the device. These are stress ratings only, and functional operation of the device at these or any other conditions beyond those indicated in the operational sections of the specifications is not implied. Exposure to absolute maximum rating conditions for extended periods may affect device reliability.

Package Information

PACKAGE TYPE: 28-PIN SiP	
Package Code	L286510#7
Outline Number	21-100180
Land Pattern Number	90-100058
THERMAL RESISTANCE, FOUR-LAYER BOARD (Note 2)	
Junction to Ambient (θ_{JA})	25.5°C/W

For the latest package outline information and land patterns (footprints), go to www.maximintegrated.com/packages. Note that a "+", "#", or "-" in the package code indicates RoHS status only. Package drawings may show a different suffix character, but the drawing pertains to the package regardless of RoHS status.

- Note 1:** Junction temperature greater than +125°C degrades operating lifetimes.
- Note 2:** Package thermal resistance is measured on an evaluation board with natural convection.

Electrical Characteristics

($V_{IN} = V_{EN}/UVLO = 24V$, $R_{RT}/SYNC = 40.2k\Omega$, $V_{PGND} = V_{SGND} = EXT_{VCC_C} = 0$, $SS_C = SS = \overline{RESET} = V_{CC} = LX = BST = EXT_{VCC_R} = OUT = OPEN$, $V_{FB} = 1V$, $T_A = -40^\circ C$ to $+125^\circ C$, unless otherwise noted. Typical values are at $T_A = +25^\circ C$. All voltages are referenced to SGND, unless otherwise noted) (Note 3)

PARAMETER	SYMBOL	CONDITIONS	MIN	TYP	MAX	UNITS
INPUT SUPPLY (V_{IN})						
Input-Voltage Range	V_{IN}		4.5		60	V
Input-Shutdown Current	$I_{IN(SH)}$	$V_{EN}/UVLO = 0V$ (shutdown mode)		12	16	μA
Input-Quiescent Current	I_{Q_PWM}	Normal switching mode, $V_{OUT} = 5.0V$, $f_{SW} = 900kHz$, $EXT_{VCC_C} = EXT_{VCC_R}$		7.7		mA
EN/UVLO (EN)						
EN/UVLO Threshold	V_{ENR}	$V_{EN}/UVLO$ rising	1.19	1.215	1.26	V
	V_{ENF}	$V_{EN}/UVLO$ falling	1.068	1.09	1.131	
EN/UVLO Pullup Resistor	R_{ENP}	Pullup resistor between V_{IN} and EN/ UVLO pins	3.15	3.3	3.45	M Ω
LDO (V_{CC})						
V_{CC} Output-Voltage Range	V_{CC}	$1mA \leq I_{VCC} \leq 15mA$	4.75	5	5.25	V
		$6V \leq V_{IN} \leq 60V$; $I_{VCC} = 1mA$	4.75	5	5.25	
V_{CC} Current Limit	$I_{VCC(MAX)}$	$V_{CC} = 4.3V$, $V_{IN} = 6.5V$	25	54	100	mA
V_{CC} Dropout	$V_{CC(DO)}$	$V_{IN} = 4.5V$, $I_{VCC} = 15mA$			0.35	V
V_{CC} UVLO	$V_{CC(UVR)}$	V_{CC} rising	4.05	4.2	4.3	V
	$V_{CC(UVF)}$	V_{CC} falling	3.65	3.8	3.9	
EXT LDO (EXT_{VCC_C})						
EXTVCC_C Switch-Over Voltage		EXTVCC_C rising	4.56	4.7	4.84	V
		EXTVCC_C falling	4.3	4.45	4.6	
EXTVCC_C Dropout	$EXT_{VCC(DO)}$	$EXT_{VCC_C} = 4.75V$, $I_{EXT_{VCC}} = 15mA$			0.3	V
EXTVCC_C Current Limit	$EXT_{VCC_C_ILIM}$	$V_{CC} = 4.5V$, $EXT_{VCC_C} = 7V$	26.5	60	100	mA
SOFT-START (SS)						
Soft-Start Current	I_{SS}	$V_{SS} = 0.5V$	4.7	5	5.3	μA
OUTPUT SPECIFICATIONS						
Line-Regulation Accuracy		$V_{OUT} = 5V$		0.1		mV/V
Load-Regulation Accuracy				1		mV/A
FB Regulation Voltage	V_{FB_REG}		0.889	0.9	0.911	V
FB Input-Bias Current	I_{FB}	$0V \leq V_{FB} \leq 1V$, $T_A = 25^\circ C$	-50		+50	nA
FB Undervoltage Trip Level to Cause HICCUP	$V_{FB(HICF)}$		0.56	0.58	0.65	V
HICCUP Timeout				32768		Cycles

Electrical Characteristics (continued)

($V_{IN} = V_{EN}/UVLO = 24V$, $R_{RT}/SYNC = 40.2k\Omega$, $V_{PGND} = V_{SGND} = EXT_{VCC_C} = 0$, $SS_C = SS = \overline{RESET} = V_{CC} = LX = BST = EXT_{VCC_R} = OUT = OPEN$, $V_{FB} = 1V$, $T_A = -40^\circ C$ to $+125^\circ C$, unless otherwise noted. Typical values are at $T_A = +25^\circ C$. All voltages are referenced to SGND, unless otherwise noted) (Note 3)

PARAMETER	SYMBOL	CONDITIONS	MIN	TYP	MAX	UNITS
$R_{RT}/SYNC$						
Switching Frequency	f_{SW}	$R_{RT} = OPEN$	430	490	550	kHz
		$R_{RT} = 51.1K\Omega$	370	400	430	
		$R_{RT} = 40.2K\Omega$	475	500	525	
		$R_{RT} = 8.06K\Omega$	1950	2200	2450	
Synchronization Frequency-Capture Range		f_{SW} set by R_{RT}	$1.1 \times f_{SW}$		$1.4 \times f_{SW}$	
Synchronization Pulse Width			50			ns
Synchronization Threshold	V_{IL}				0.8	V
	V_{IH}		2.1			
Minimum On-Time	t_{ON_MIN}			60	80	ns
Minimum Off-Time	t_{OFF_MIN}		140	150	160	ns
\overline{RESET}						
\overline{RESET} Output-Level Low		$I_{\overline{RESET}} = 10mA$			400	mV
\overline{RESET} Output-Leakage Current		$T_A = T_J = 25^\circ C$, $V_{\overline{RESET}} = 5.5V$	-100		100	nA
V_{OUT} Threshold for \overline{RESET} Assertion	$V_{OUT(OKF)}$	V_{FB} falling	90.5	92	94.6	%
V_{OUT} Threshold for \overline{RESET} Deassertion	$V_{OUT(OKR)}$	V_{FB} rising	93.8	95	97.8	%
\overline{RESET} Delay after FB Reaches 95% Regulation				1024		Cycles
THERMAL SHUTDOWN						
Thermal Shutdown Threshold	T_{SHDNR}	Temp rising		165		$^\circ C$
Thermal Shutdown Hysteresis	T_{SHDNHY}			10		$^\circ C$

Note 3: Electrical specification are production tested at $T_A = +25^\circ C$. Specifications over the entire operating range is guaranteed by design and characterization.

Typical Operating Characteristics

($V_{IN} = 24V$, $V_{SGND} = V_{PGND} = 0V$, $T_A = -40^{\circ}C$ to $+125^{\circ}C$, unless otherwise noted. Typical values are at $T_A = +25^{\circ}C$. All voltages are referenced to SGND, unless otherwise noted. The circuit values for different output voltage applications are as in Table 1, unless otherwise noted.)

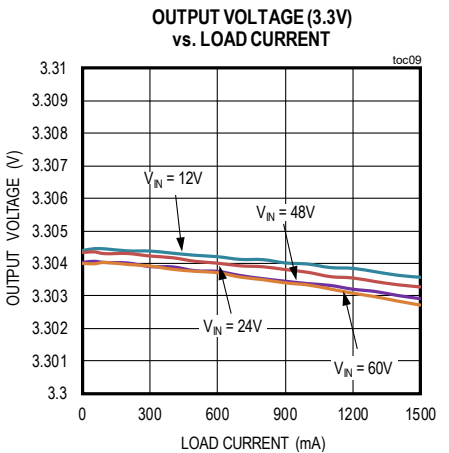
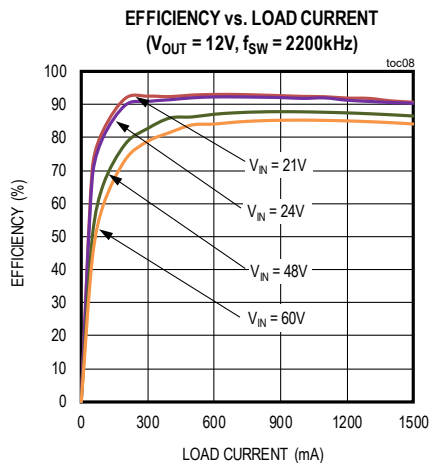
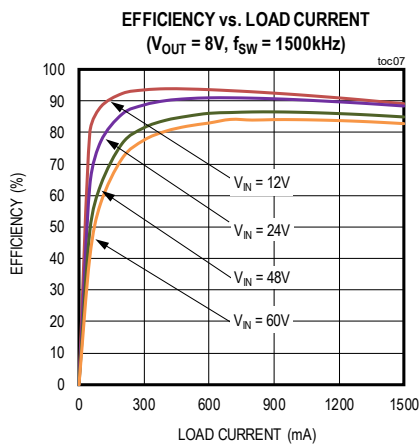
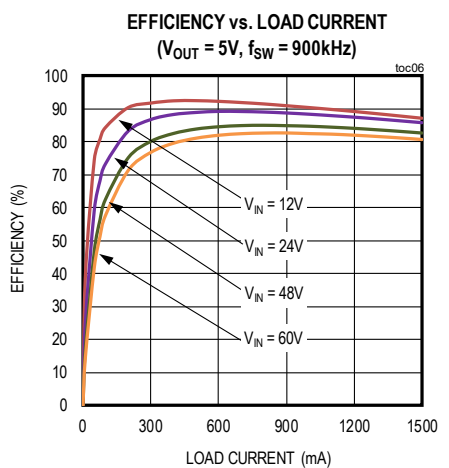
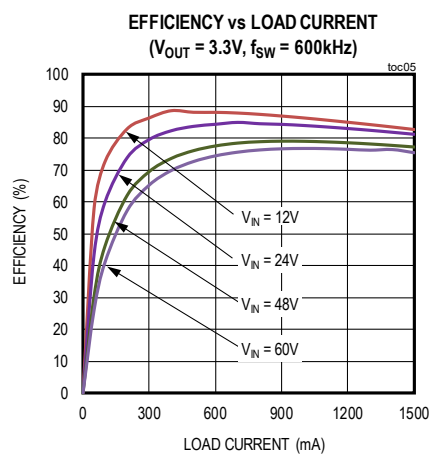
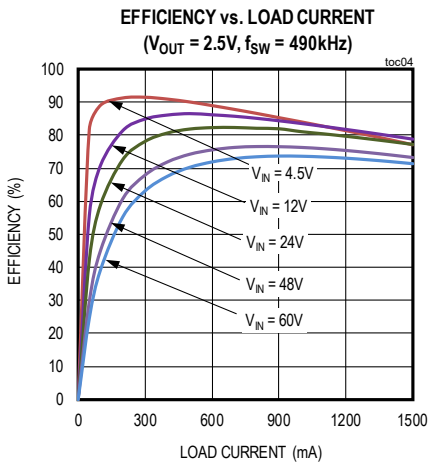
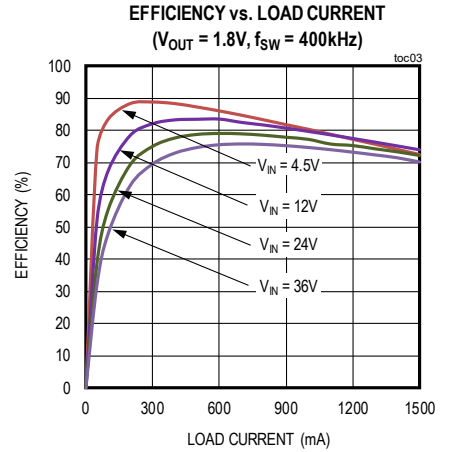
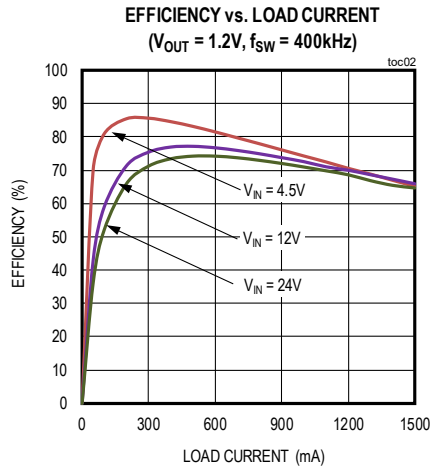
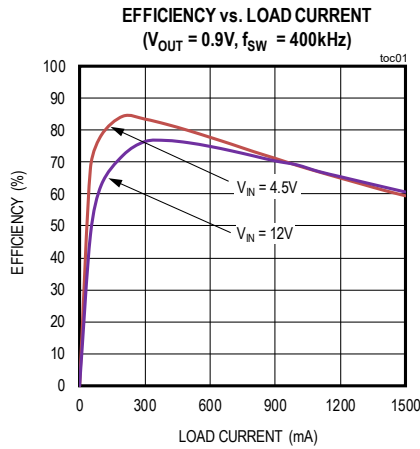

Typical Operating Characteristics (continued)

($V_{IN} = 24V$, $V_{SGND} = V_{PGND} = 0V$, $T_A = -40^{\circ}C$ to $+125^{\circ}C$, unless otherwise noted. Typical values are at $T_A = +25^{\circ}C$. All voltages are referenced to SGND, unless otherwise noted. The circuit values for different output voltage applications are as in Table 1, unless otherwise noted.)

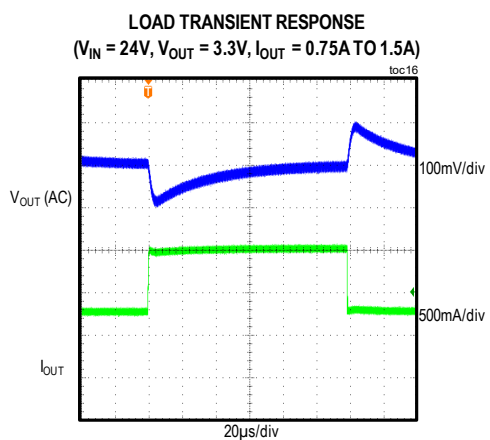
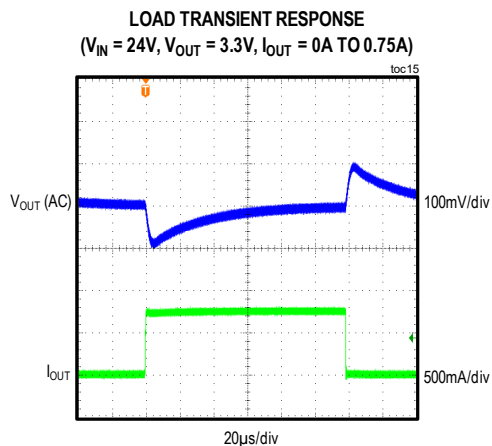
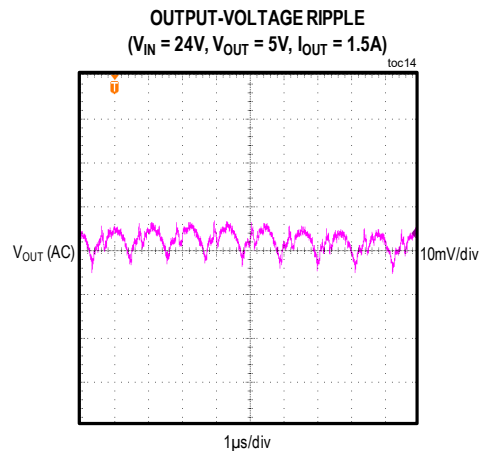
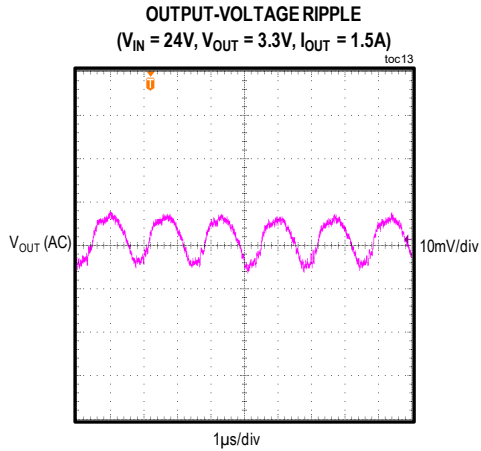
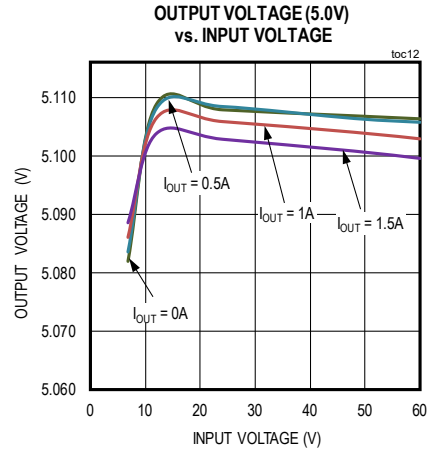
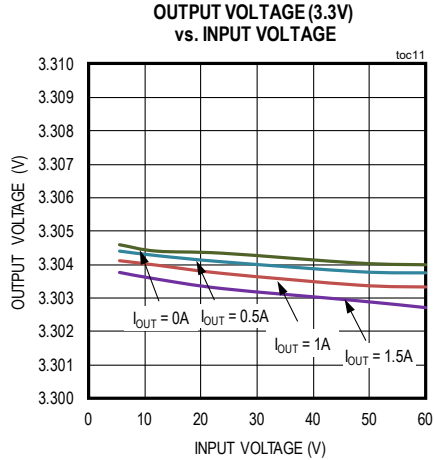
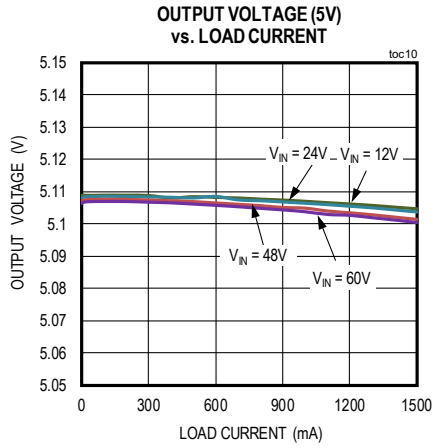

Typical Operating Characteristics (continued)

($V_{IN} = 24V$, $V_{SGND} = V_{PGND} = 0V$, $T_A = -40^{\circ}C$ to $+125^{\circ}C$, unless otherwise noted. Typical values are at $T_A = +25^{\circ}C$. All voltages are referenced to SGND, unless otherwise noted. The circuit values for different output voltage applications are as in [Table 1](#), unless otherwise noted.)

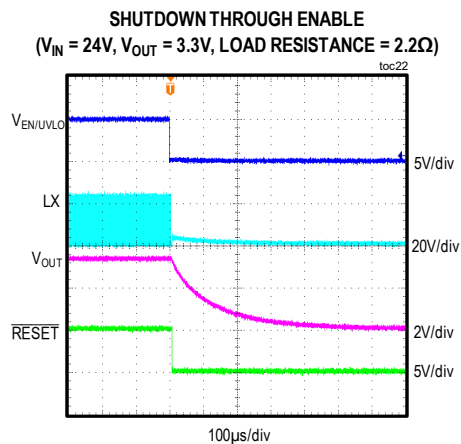
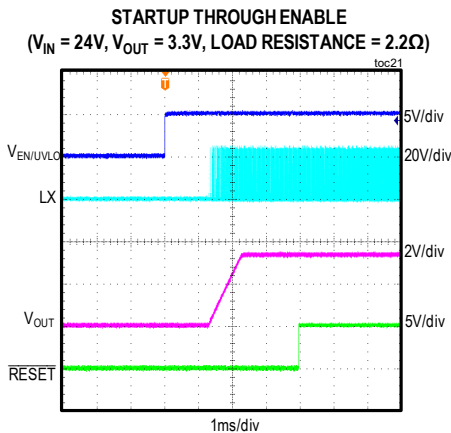
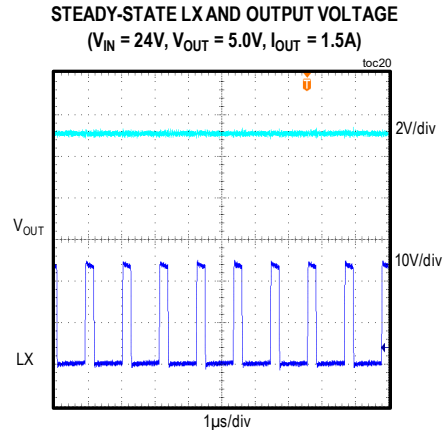
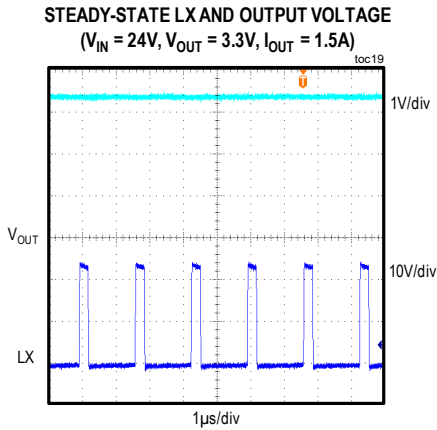
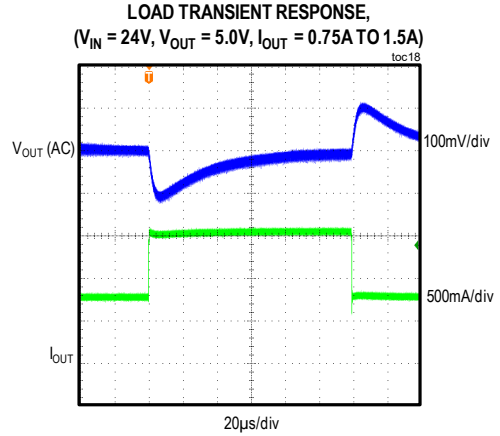
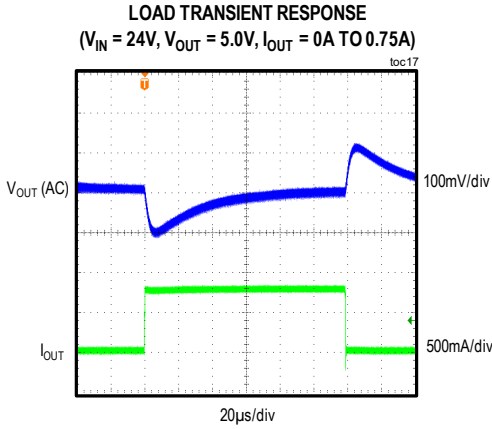

Typical Operating Characteristics (continued)

($V_{IN} = 24V$, $V_{SGND} = V_{PGND} = 0V$, $T_A = -40^{\circ}C$ to $+125^{\circ}C$, unless otherwise noted. Typical values are at $T_A = +25^{\circ}C$. All voltages are referenced to SGND, unless otherwise noted. The circuit values for different output voltage applications are as in Table 1, unless otherwise noted.)

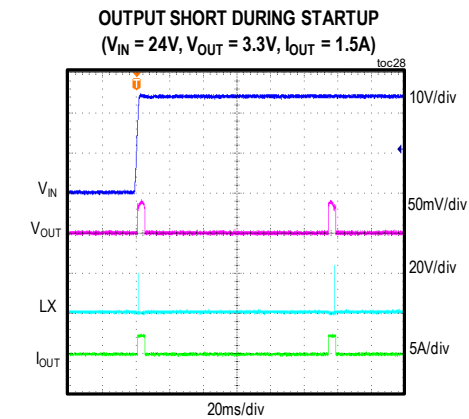
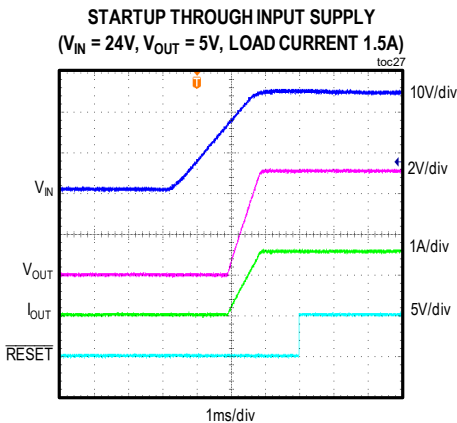
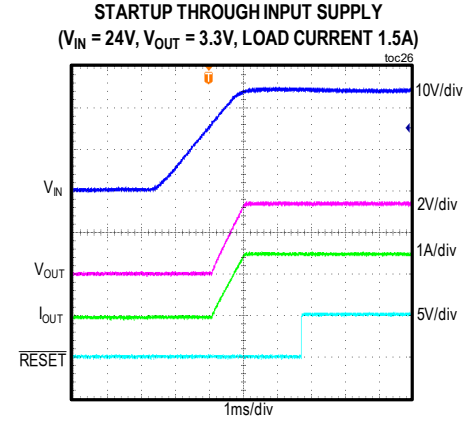
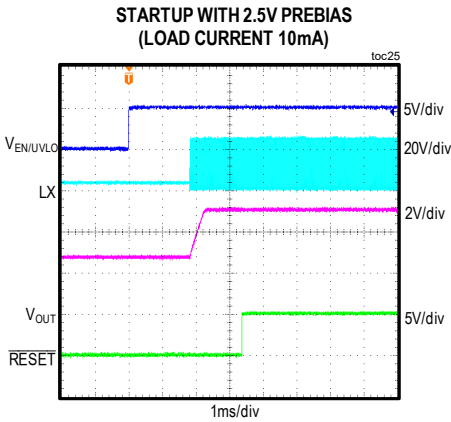
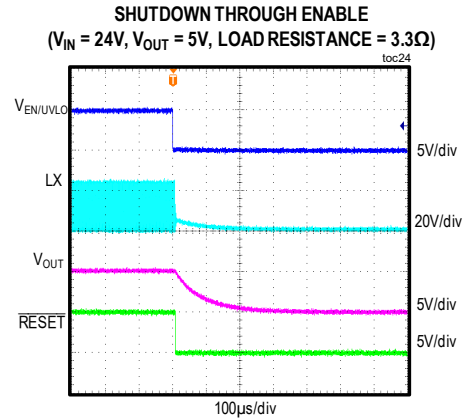
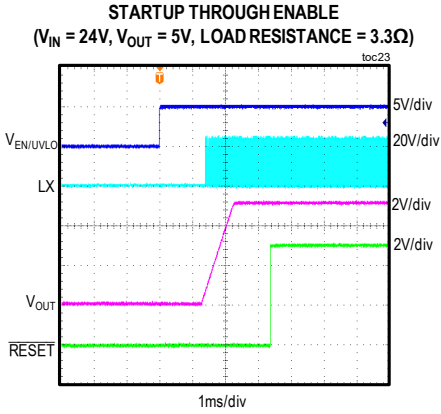

Typical Operating Characteristics (continued)

($V_{IN} = 24V$, $V_{SGND} = V_{PGND} = 0V$, $T_A = -40^{\circ}C$ to $+125^{\circ}C$, unless otherwise noted. Typical values are at $T_A = +25^{\circ}C$. All voltages are referenced to SGND, unless otherwise noted. The circuit values for different output voltage applications are as in [Table 1](#), unless otherwise noted.)

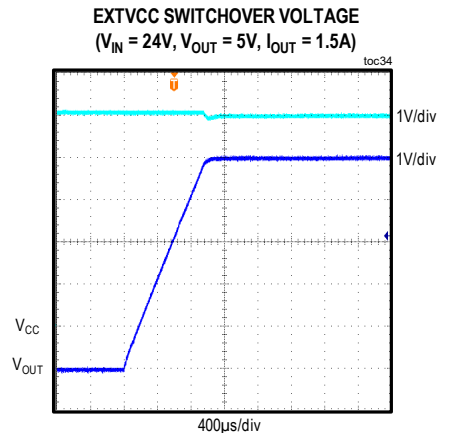
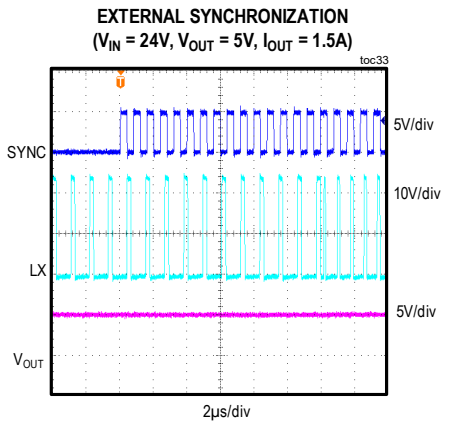
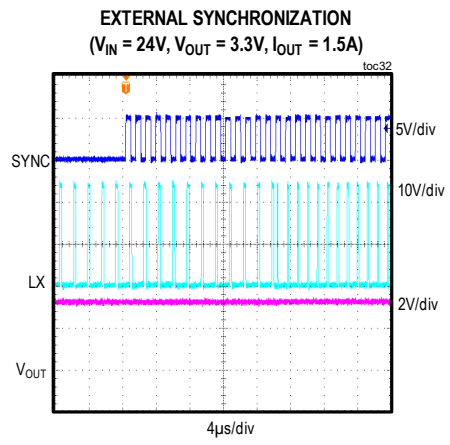
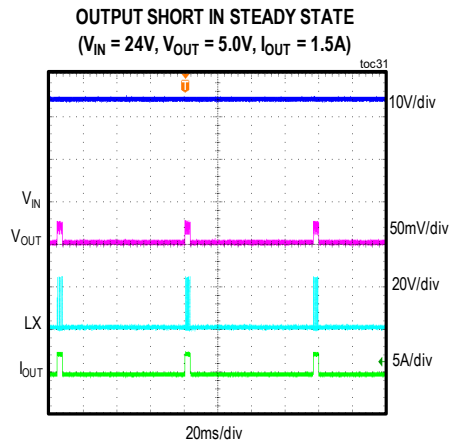
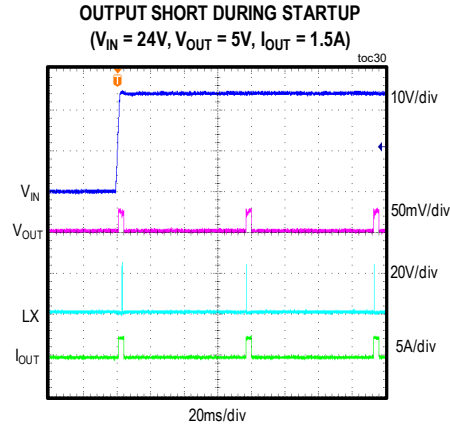
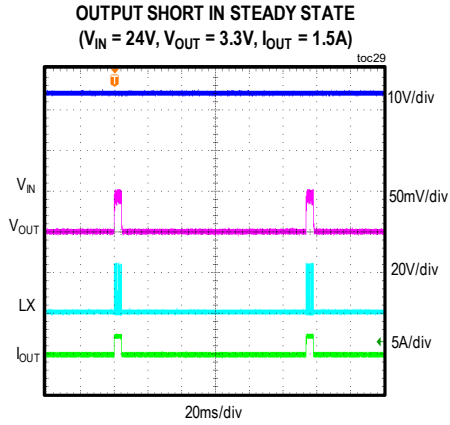

Typical Operating Characteristics (continued)

($V_{IN} = 24V$, $V_{SGND} = V_{PGND} = 0V$, $T_A = -40^{\circ}C$ to $+125^{\circ}C$, unless otherwise noted. Typical values are at $T_A = +25^{\circ}C$. All voltages are referenced to SGND, unless otherwise noted. The circuit values for different output voltage applications are as in Table 1, unless otherwise noted.)

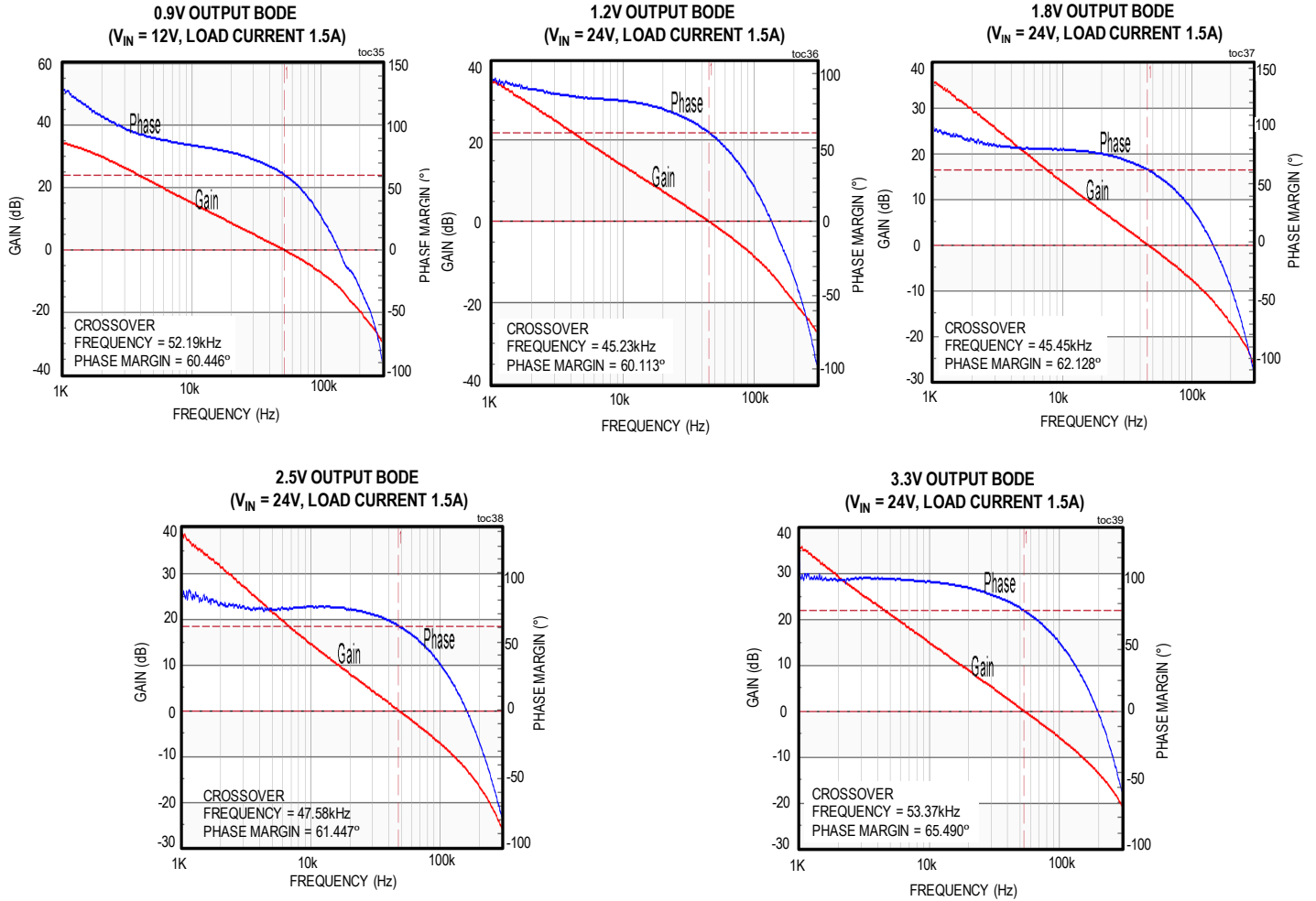

Typical Operating Characteristics (continued)

($V_{IN} = 24V$, $V_{SGND} = V_{PGND} = 0V$, $T_A = -40^{\circ}C$ to $+125^{\circ}C$, unless otherwise noted. Typical values are at $T_A = +25^{\circ}C$. All voltages are referenced to SGND, unless otherwise noted. The circuit values for different output voltage applications are as in Table 1, unless otherwise noted.)

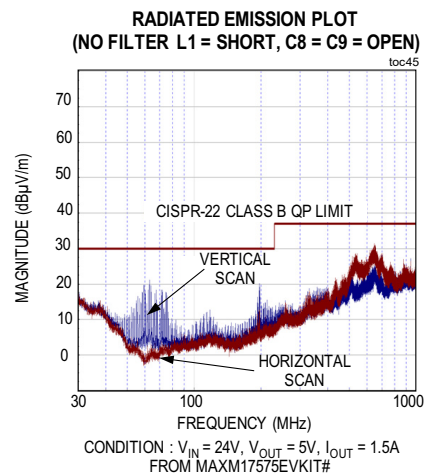
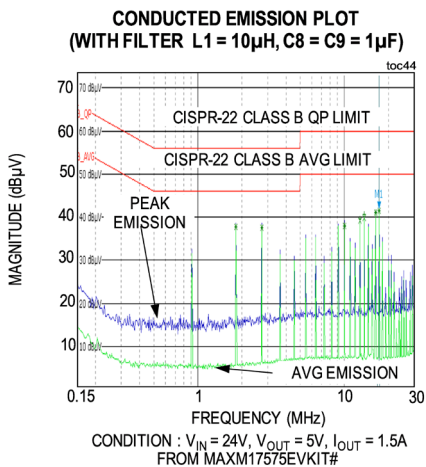
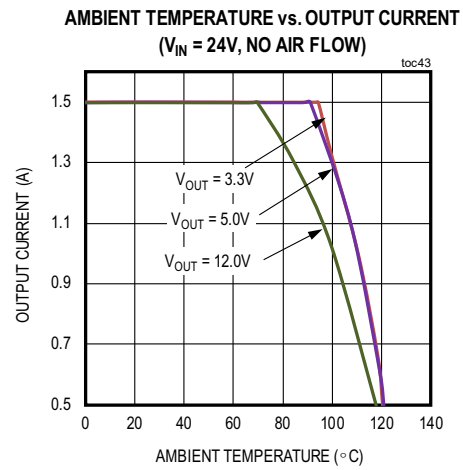
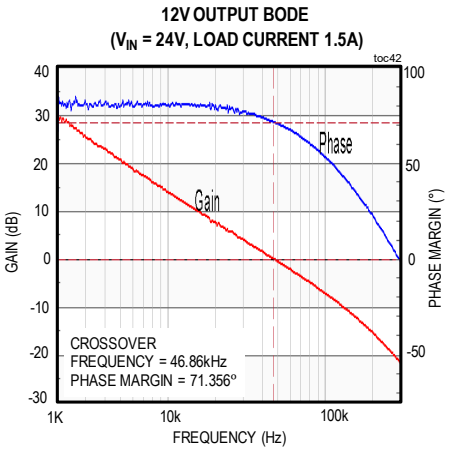
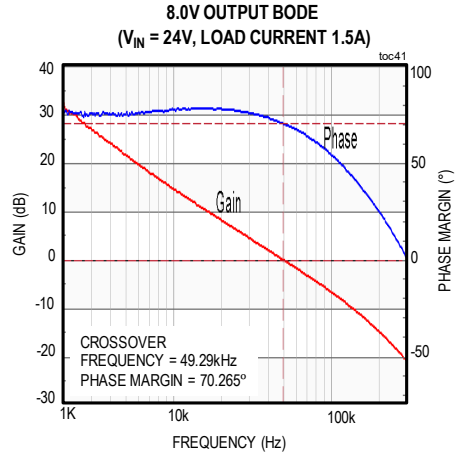
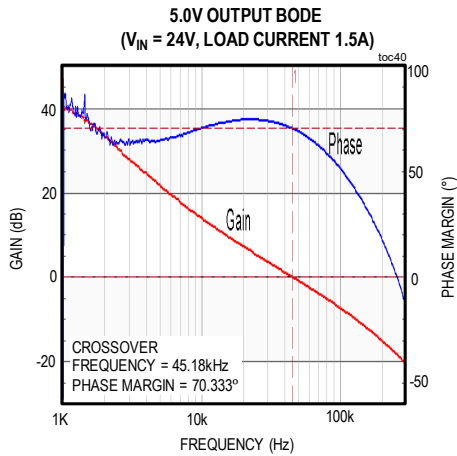

Pin Configuration

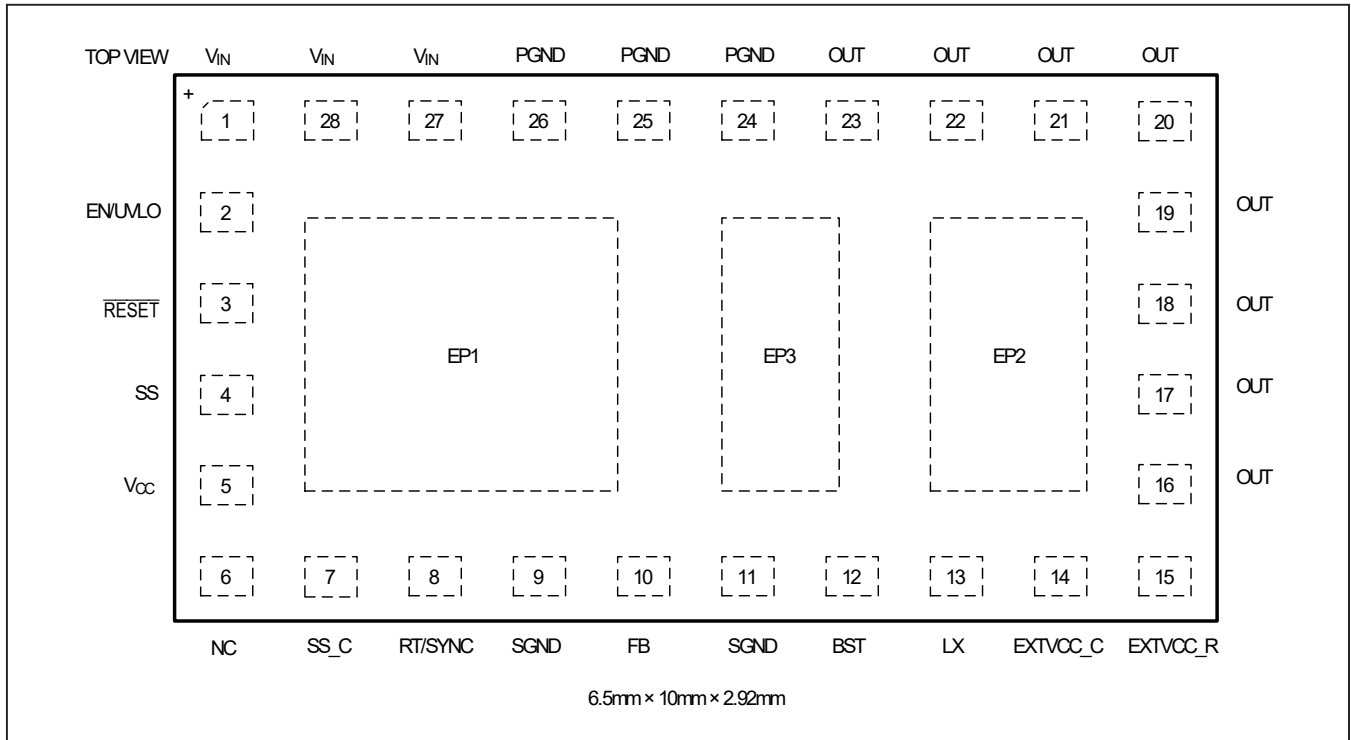

Pin Description

PIN	NAME	FUNCTION
1, 27, 28	V _{IN}	Power-Supply Input. Connect the V _{IN} pins together. Decouple to PGND with a capacitor; place the capacitor close to the V _{IN} and PGND pins.
2	EN/UVLO	Enable/Undervoltage Lockout Input. Connect a resistor from EN/UVLO to SGND to set the UVLO threshold. See the Input Undervoltage-Lockout Level section for more details.
3	$\overline{\text{RESET}}$	Open-Drain $\overline{\text{RESET}}$ Output. The $\overline{\text{RESET}}$ output is driven low if FB drops below 92% of its set value. $\overline{\text{RESET}}$ goes high 1024 clock cycles after FB rises above 95% of its set value.
4	SS	Soft-Start Input. Connect a capacitor from SS to SGND to set the soft-start time.
5	V _{CC}	5V LDO Output. The V _{CC} is bypassed to PGND internally through a 2.2 μ F capacitor. Do not connect external components to the V _{CC} pin.
6	NC	Not Connected
7	SS_C	Soft-Start Capacitor Node. Internally a 5600pF is connected from SS_C to SGND. Connect this pin with a short trace to SS to use the internal cap for the soft-start function.
8	RT/SYNC	Oscillator Timing Resistor Input. Connect a resistor from RT/SYNC to SGND to program the switching frequency from 400kHz to 2.2MHz. An external pulse can be applied to RT/SYNC through a coupling capacitor to synchronize the internal clock to the external pulse frequency.
9, 11	SGND	Analog Ground.
10	FB	Feedback Input. Connect FB node to the junction of the external feedback divider network from the OUT to SGND to set the output voltage.
12	BST	Boost Flying Capacitor Node. Internally a 0.1 μ F is connected from BST to LX. Do not connect external components to BST pin.
13	LX	Internally Shorted to Switching Node. Do not connect external components to LX pin.
14	EXTVCC_C	External Power-Supply Input for the Internal LDO. For applications with output voltage > 5V, connect EXTVCC_C to EXTVCC_R pin to improve the efficiency. For other applications, EXTVCC_C should be connected to SGND.
15	EXTVCC_R	Input Pin for the EXTVCC_C Supply. Connect to EXTVCC_C for an output voltage \geq 5V. When this function is unused, EXTVCC_R should be left OPEN. Other than EXTVCC_C, do not connect any external components to EXTVCC_R.
16–23	OUT	Regulator Output Pin. Connect a capacitor from OUT to PGND. See the <i>PCB Layout Guidelines</i> section for connection details.
24–26	PGND	Power Ground. Connect the PGND pins externally to the power ground plane.
EP1	SGND	Exposed Pad. Connect to the SGND of the module. Connect to a large copper plane below the IC to improve heat dissipation capability.
EP2	OUT	Exposed Pad. Connect to the OUT pins of the module. Connect to a large copper plane below the IC to improve heat dissipation capability.
EP3	NC	Exposed Pad. Not connected

Functional Diagram

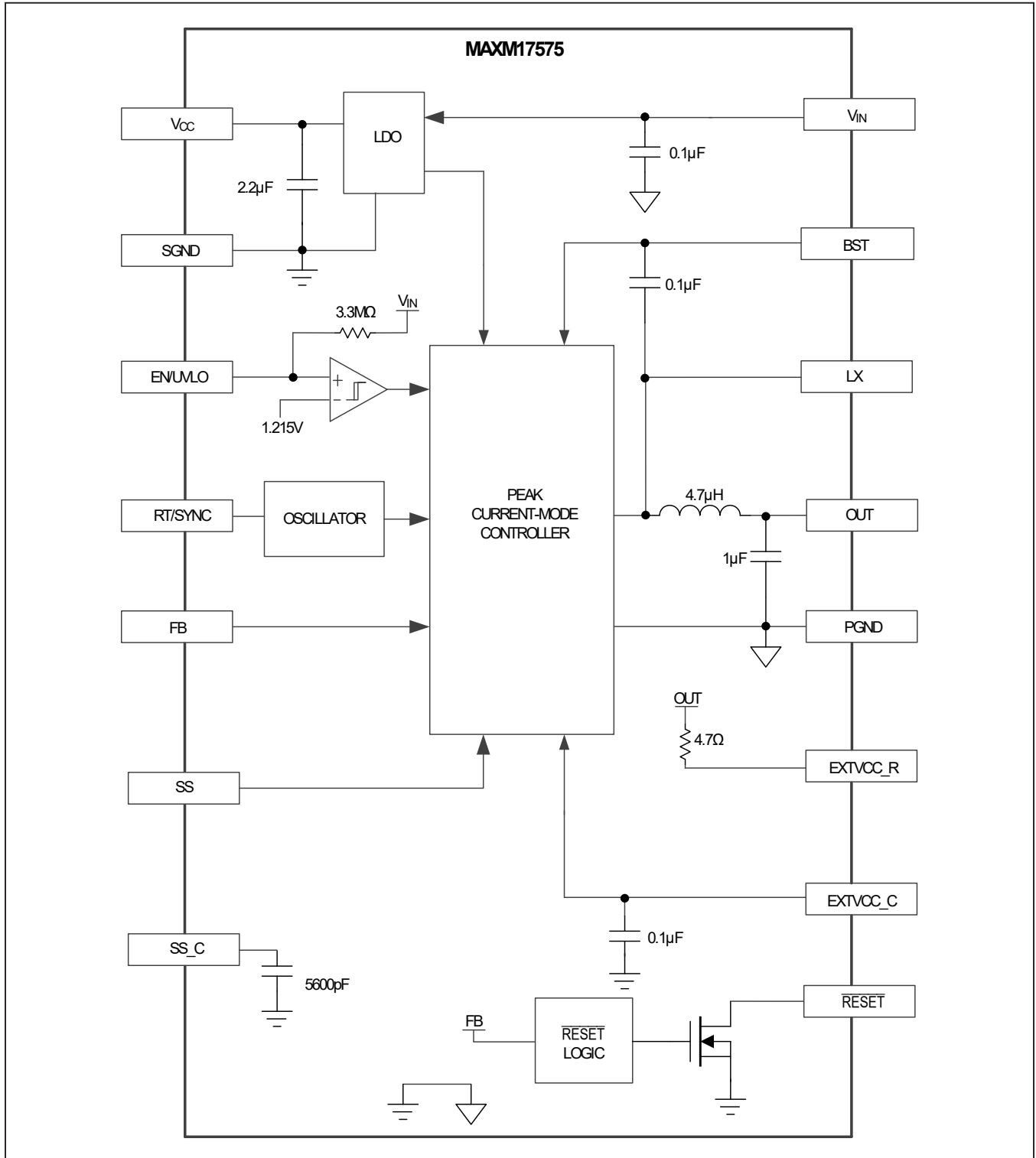

Detailed Description

The MAXM17575 is a high-efficiency, high-voltage step-down power module with dual-integrated MOSFETs that operates over a 4.5V to 60V input and supports a programmable output voltage from 0.9V to 12V, delivering up to 1.5A current. The MAXM17575 module integrates all the necessary components required for switching the converter. Built-in compensation for the entire output-voltage range eliminates the need for external components.

The MAXM17575 features a peak-current-mode control architecture and operates the device in pulse-width modulation (PWM) mode providing a constant frequency operation at all loads, and is useful in applications sensitive to variable switching frequency. The device also features an RT/SYNC pin to program the switching frequency. A programmable soft-start feature allows users to reduce input inrush current. The device also incorporates an output enable/undervoltage lockout pin (EN/UVLO) that allows the user to turn on the part at the desired input-voltage level. An open-drain RESET pin provides a delayed power-good signal to the system upon achieving successful regulation of the output voltage.

Linear Regulator

The MAXM17575 has two internal low dropout (LDO) regulators that powers V_{CC} . One LDO is powered from V_{IN} (LDO) and the other LDO is powered from EXT V_{CC_C} (EXTLDO). During power-up, when the Enable pin voltage is above the true shutdown voltage, then the V_{CC} is powered from LDO. When V_{CC} voltage is above the V_{CC} UVLO threshold and EXT V_{CC_C} voltage is greater than 4.7V (typ), then the V_{CC} is powered from EXTLDO. Only one of the two LDOs is in operation at a time, depending on the voltage levels present at EXT V_{CC_C} . Powering V_{CC} from EXTLDO increases efficiency at higher input voltages. EXT V_{CC_C} voltage should not exceed 24V.

The typical V_{CC} output voltage is 5V. In applications where the buck converter output is connected to the EXT V_{CC_C} pin, if the output is shorted to ground, then transfer from EXTLDO to the LDO happens seamlessly without any impact on the normal functionality.

External Frequency Synchronization (RT/SYNC)

The internal oscillator of the MAXM17575 can be synchronized to an external clock signal through the RT/SYNC pin. The external clock should be coupled to the RT/SYNC pin using the circuit as shown in [Figure 1](#). The external synchronization clock frequency must be between $1.1 \times f_{SW}$ and $1.4 \times f_{SW}$, where f_{SW} is

the frequency programmed by the RT resistor (R_{RT}). When an external clock is applied to the RT/SYNC pin, the internal oscillator frequency changes to external clock frequency (from original frequency based on the RT setting) after detecting 16 external clock edges. The minimum external clock high pulse width and amplitude should be greater than 50ns and 2.1V respectively. The maximum external clock low pulse amplitude should be less than 0.8V.

Operating Input-Voltage Range

The minimum and maximum operating input voltages for a given output voltage should be calculated as follows:

$$V_{IN(MIN)} = \frac{V_{OUT} + (I_{OUT(MAX)} \times 0.425)}{1 - (f_{SW(MAX)} \times t_{OFF_MIN(MAX)})} + (I_{OUT(MAX)} \times 0.30)$$

$$\text{For Duty Cycle, } D > 0.3: V_{IN(MIN)} > 4.2 \times V_{OUT} - \frac{f_{SW(MIN)}}{66000}$$

$$V_{IN(MAX)} = \frac{V_{OUT}}{f_{SW(MAX)} \times t_{ON_MIN(MAX)}}$$

where,

V_{OUT} = Steady-state output voltage,

$I_{OUT(MAX)}$ = Maximum load current,

$f_{SW(MAX)}$ = Maximum switching frequency,

$t_{OFF_MIN(MAX)}$ = Worst-case minimum switch off-time (160ns)

$t_{ON_MIN(MAX)}$ = Worst-case minimum switch on-time (80ns)

$f_{SW(MIN)}$ = Minimum switching frequency

[Table 1](#) provides operating input voltage range and optimum switching frequency for different selected output voltages.

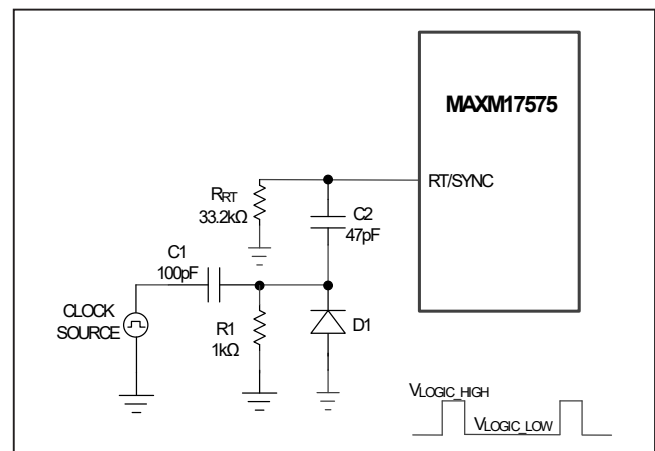

Figure 1. External Clock Synchronization

RESET Output

The device includes a $\overline{\text{RESET}}$ pin to monitor the output voltage. The open-drain $\overline{\text{RESET}}$ output requires an external pullup resistor. $\overline{\text{RESET}}$ goes high-impedance 1024 switching cycles after the regulator output increases above 95% of the designed nominal regulated voltage. $\overline{\text{RESET}}$ goes low when the regulator output voltage drops below 92% of the nominal regulated voltage. $\overline{\text{RESET}}$ also goes low during thermal shutdown.

Thermal Fault Protection

The MAXM17575 features a thermal-fault protection circuit. When the junction temperature rises above 165°C (typ), a thermal sensor activates the fault latch, pulls down the $\overline{\text{RESET}}$ output, and shuts down the regulator. The controller soft-starts after the junction temperature cools down by 10°C.

Overcurrent Protection (OCP)

The MAXM17575 is provided with a robust overcurrent protection (OCP) scheme that protects the modules under overload and output short-circuit conditions. A cycle-by-cycle peak current limit turns off the high-side MOSFET whenever the high-side switch current exceeds an internal limit of 2.45A (typ). The module enters hiccup mode of operation either after one occurrence of the runaway current limit 2.75A (typ) or when the FB node goes below 64.5% of its nominal regulation threshold after soft-start is complete. In hiccup mode, the module is protected by suspending switching for a hiccup timeout period of 32,768 clock cycles. Once the hiccup timeout period expires, soft-start is attempted again. Hiccup mode of operation ensures low power dissipation under output overload or short-circuit conditions. Note that when soft-start is attempted under overload condition, if feedback voltage does not exceed 64.5% of desired output voltage, the device switches at half the programmed switching frequency.

The MAXM17575 is designed to support a maximum load current of 1.5A. The inductor ripple current is calculated as follows:

$$\Delta I = \left[\frac{V_{\text{IN}} - V_{\text{OUT}} - 0.725 \times I_{\text{OUT}}}{L \times f_{\text{SW}}} \right] \times \left[\frac{V_{\text{OUT}} + 0.425 \times I_{\text{OUT}}}{V_{\text{IN}} - 0.3 \times I_{\text{OUT}}} \right]$$

where,

V_{OUT} = Steady-state output voltage

V_{IN} = Operating input voltage

f_{SW} = Switching frequency

L = Power module output inductance (4.7μH ±20%)

I_{OUT} = Required output (load) current

The following condition should be satisfied at the desired load current (I_{OUT}).

$$I_{\text{OUT}} + \frac{\Delta I}{2} < 2.1$$

Applications Information

Input-Capacitor Selection

The input capacitor serves to reduce the current peaks drawn from the input power supply and reduces switching noise from the module. The input capacitor values in [Table 1](#) are the minimum recommended values for desired input and output voltages. Applying capacitor values larger than those indicated in [Table 1](#) are acceptable to improve the dynamic response. For further operating conditions, the total input capacitance must be greater than or equal to the value given by the following equation in order to keep the input-voltage ripple within specifications and to minimize the high-frequency ripple current being fed back to the input source:

$$C_{\text{IN}} = \frac{I_{\text{IN(AVG)}} \times (1-D)}{\Delta V_{\text{IN}} \times f_{\text{SW}}}$$

where $I_{\text{IN(AVG)}}$ is the average input current given by:

$$I_{\text{IN(AVG)}} = \frac{P_{\text{OUT}}}{\eta \times V_{\text{IN}}}$$

and where,

D = The operating duty cycle, which is approximately equal to $V_{\text{OUT}}/V_{\text{IN}}$.

ΔV_{IN} = The required input-voltage ripple.

f_{SW} = The operating switching frequency.

P_{OUT} = The out power, which is equal to $V_{\text{OUT}} \times I_{\text{OUT}}$.

η = The efficiency.

The input capacitor must meet the ripple-current requirement imposed by the switching currents. The RMS input-ripple current is given by:

$$I_{\text{RMS}} = I_{\text{OUT(MAX)}} \times \frac{\sqrt{V_{\text{OUT}} \times (V_{\text{IN}} - V_{\text{OUT}})}}{V_{\text{IN}}}$$

The worst-case RMS current requirement occurs when operating with $D = 0.5$. At this point, the above equation simplifies to $I_{\text{RMS}} = 0.5 \times I_{\text{OUT}}$.

In applications where the source is located distant from the device input, an electrolytic capacitor should be added

in parallel to the ceramic capacitor to provide necessary damping for potential oscillations caused by the inductance of the longer input power path and input ceramic capacitor. Choose an input capacitor that exhibits less than +10°C temperature rise at the RMS input current for optimal circuit longevity.

Output-Capacitor Selection

The X7R ceramic output capacitors are preferred due to their stability over temperature in industrial applications. The minimum recommended output capacitor values are

listed in [Table 1](#) for desired output voltages to support a dynamic step load of 50% of the maximum output current and to contain the output-voltage deviation to 3% of the output voltage. For additional adjustable output voltages, the output capacitance value is derived from the following equation:

$$C_{OUT} = \frac{90}{V_{OUT}}$$

where C_{OUT} is the output capacitance in μF

Table 1. Selection of Component Values

$V_{IN(MIN)}$ (V)	$V_{IN(MAX)}$ (V)	V_{OUT} (V)	C_{IN}	C_{OUT}	R_U (k Ω)	R_B (k Ω)	f_{SW} (kHz)	R_{RT} (k Ω)	C_{SS} (PF)
4.5	15	0.9	1 × 4.7 $\mu\text{F}/25\text{V}$ 1210	2 × 47 $\mu\text{F}/10\text{V}$ 1210	18.7	OPEN	400	51.1	OPEN
4.5	15	1	1 × 4.7 $\mu\text{F}/25\text{V}$ 1210	2 × 47 $\mu\text{F}/10\text{V}$ 1210	18.2	162	400	51.1	OPEN
	28		1 × 4.7 $\mu\text{F}/50\text{V}$ 1210						OPEN
4.5	15	1.2	1 × 4.7 $\mu\text{F}/25\text{V}$ 1210	1 × 47 μF + 1 × 22 $\mu\text{F}/10\text{V}$ 1210	26	78.7	400	51.1	OPEN
	28		1 × 4.7 $\mu\text{F}/50\text{V}$ 1210						OPEN
4.5	15	1.5	1 × 4.7 $\mu\text{F}/25\text{V}$ 1210	1 × 47 μF + 1 × 22 $\mu\text{F}/10\text{V}$ 1210	27	40.2	400	51.1	OPEN
	40		1 × 4.7 $\mu\text{F}/50\text{V}$ 1210						OPEN
4.5	15	1.8	1 × 4.7 $\mu\text{F}/25\text{V}$ 1210	1 × 47 μF + 1 × 10 $\mu\text{F}/10\text{V}$ 1210	33.2	33.2	400	51.1	OPEN
	40		1 × 4.7 $\mu\text{F}/50\text{V}$ 1210						OPEN
4.5	15	2.5	1 × 4.7 $\mu\text{F}/25\text{V}$ 1210	2 × 22 $\mu\text{F}/10\text{V}$ 1210	33.2	18.7	490	OPEN	OPEN
	40		1 × 4.7 $\mu\text{F}/50\text{V}$ 1210						OPEN
	60		1 × 4.7 $\mu\text{F}/80\text{V}$ 1210						OPEN
5.0	15	3.3	1 × 4.7 $\mu\text{F}/25\text{V}$ 1210	1 × 22 $\mu\text{F}/10\text{V}$ 1210	60.4	22.6	600	33.2	OPEN
	40		1 × 4.7 $\mu\text{F}/50\text{V}$ 1210						OPEN
	60		1 × 4.7 $\mu\text{F}/80\text{V}$ 1210						OPEN
7.5	15	5	1 × 2.2 $\mu\text{F}/25\text{V}$ 1210	1 × 22 $\mu\text{F}/10\text{V}$ 1210	75	16.2	900	21.5	OPEN
	40		1 × 2.2 $\mu\text{F}/50\text{V}$ 1210						OPEN
	60		1 × 2.2 $\mu\text{F}/100\text{V}$ 1210						OPEN
12	15	8	1 × 1.0 $\mu\text{F}/25\text{V}$ 1210	1 × 10 μF + 1 × 4.7 $\mu\text{F}/10\text{V}$ 1210	114	14.5	1500	12.4	2200
	40		1 × 1.0 $\mu\text{F}/50\text{V}$ 1210						2200
	60		1 × 1.0 $\mu\text{F}/100\text{V}$ 1210						2200
21	40	12	1 × 1.0 $\mu\text{F}/50\text{V}$ 1210	1 × 10 $\mu\text{F}/25\text{V}$ 1210	196	15.8	2200	8.06	2200
	60		1 × 1.0 $\mu\text{F}/100\text{V}$ 1210						2200

Input Undervoltage-Lockout Level

The MAXM17575 contains an internal pullup resistor (3.3M Ω) from EN/UVLO to V_{IN} to have a default startup voltage. The device offers an adjustable input undervoltage lockout level to set the voltage at which the device is turned on by a single resistor connecting from EN/UVLO to SGND as equation:

$$R_{ENU} = \frac{3.3 \times 1.215}{V_{INU} - 1.215}$$

where R_{ENU} is in M Ω and V_{INU} is the voltage required to turn on the device. Ensure that V_{INU} is high enough to support the V_{OUT}. See [Table 1](#) to set the proper V_{INU} voltage greater than or equal to the minimum input voltage for each desired output voltage.

Setting the Switching Frequency (RT)

The switching frequency of the MAXM17575 can be programmed from 400kHz to 2.2MHz by using a resistor connected from the RT/SYNC pin to SGND. The calculation of R_{RT} is given by the following equation:

$$R_{RT} \approx \frac{21000}{f_{SW}} - 1.7$$

where R_{RT} is in k Ω and f_{SW} is in kHz.

Leave the RT/SYNC pin open to operate at the default switching frequency of 490kHz.

Soft-Start Capacitor Selection

The device implements an adjustable soft-start operation to reduce inrush current during startup. A capacitor (C_{SS}) connected from the SS pin to SGND to program the soft-start time. The selected output capacitance (C_{SEL}) and the output voltage (V_{OUT}) determine the minimum value of C_{SS}, as shown by the following equation:

$$C_{SS} \geq 56 \times 10^{-6} \times C_{SEL} \times V_{OUT}$$

The soft-start time (t_{SS}) is related to the capacitor connected at SS (C_{SS}) by the following equation:

$$t_{SS} = \frac{C_{SS}}{5.55 \times 10^{-6}}$$

For example, to program a 2ms soft-start time, a 12nF capacitor should be connected from the SS pin to SGND. Internally 5600pF is connected from SS_C to SGND. Connect a short trace between SS and SS_C to use the internal capacitor for default 1ms soft-start time.

Setting the Output Voltage

Set the output voltage with resistive voltage-divider connected from the positive terminal of the output capacitor (V_{OUT}) to SGND (see [Figure 2](#)). Connect the center node of the divider to the FB pin. Use the following procedure to choose the resistive voltage-divider values:

Calculate resistor R_U from the output to the FB pin using the equation below:

$$R_U = \frac{1850}{C_{OUT}}$$

where,

C_{OUT} (in μ F) = The actual derated value of the output capacitance used

R_U is in k Ω .

The minimum allowable value of R_U is (5.6 \times V_{OUT}). If the value of R_U calculated using the above equation is less than (5.6 \times V_{OUT}), increase the value of R_U to at least (5.6 \times V_{OUT}).

Use the following equation to calculate the R_B:

$$R_B = \frac{R_U \times 0.9}{V_{OUT} - 0.9}$$

where R_B is in k Ω .

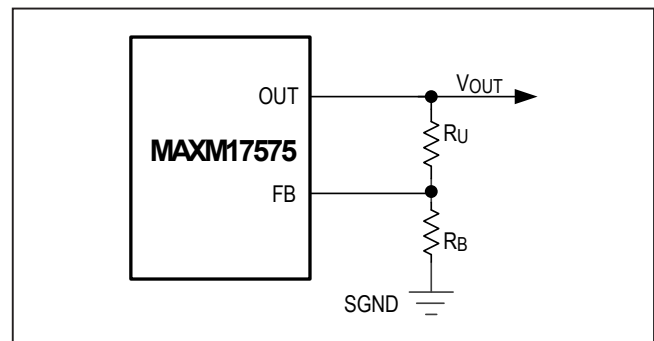

Figure 2. Adjusting Output Voltage

Power Dissipation

The power dissipation inside the module leads to an increase in the junction temperature of the MAXM17575. The power loss inside the module at full load can be estimated as:

$$P_{\text{LOSS}} = P_{\text{OUT}} \times \left[\frac{1}{\eta} - 1 \right]$$

Where η is the efficiency of the power module at the desired operating conditions. See the [Typical Operating Characteristics](#) section for the power-conversion efficiency or measure the efficiency to determine the total power dissipation. The junction temperature (T_J) of the module can be estimated at any given maximum ambient temperature (T_A) from the following equation:

$$T_J = T_A + (\theta_{JA} \times P_{\text{LOSS}})$$

For the MAXM17575 evaluation board, the thermal resistance from junction-to-ambient (θ_{JA}) is 25.5°C/W. Operating the module at junction temperatures greater than +125°C degrades operating lifetimes. An EE-SIM model is available for the MAXM17575 to simulate efficiency and power loss for the desired operating conditions.

PCB Layout Guidelines

Careful PCB layout is critical to achieving low switching losses and stable operation.

Use the following guidelines for good PCB layout:

- Keep the input capacitors as close as possible to the V_{IN} and PGND pins.
- Keep the output capacitors as close as possible to the OUT and PGND pins.
- Keep the resistive feedback dividers as close as possible to the FB pin.
- Connect all of the PGND connections to as large as possible copper plane area on the bottom layer.
- Connect EP1 to SGND plane on bottom layer.
- Use multiple vias to connect internal PGND planes to the top layer PGND plane.
- Do not keep any solder mask on EP1, EP2, and EP3 on bottom layer. Keeping solder mask on exposed pads decreases the heat dissipating capability.
- Keep the power traces and load connections short. This practice is essential for high efficiency. Using thick copper PCBs (2oz vs. 1oz) can enhance full-load efficiency. A single mΩ of excess trace resistance causes a measurable efficiency penalty.

Typical Application Circuits

5.0V Output Typical Application Circuit

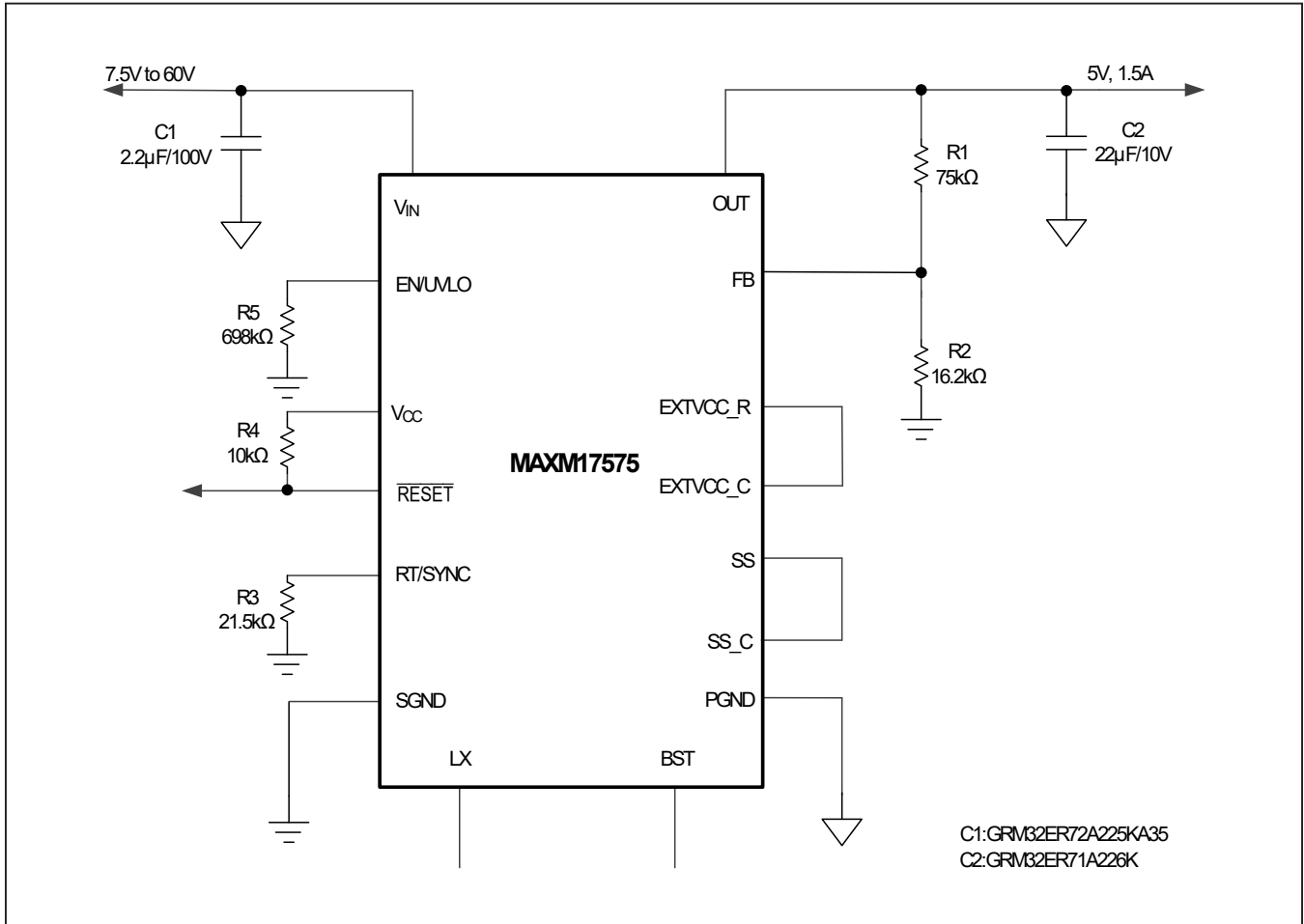

Typical Application Circuits (continued)

3.3V Output Typical Application Circuit

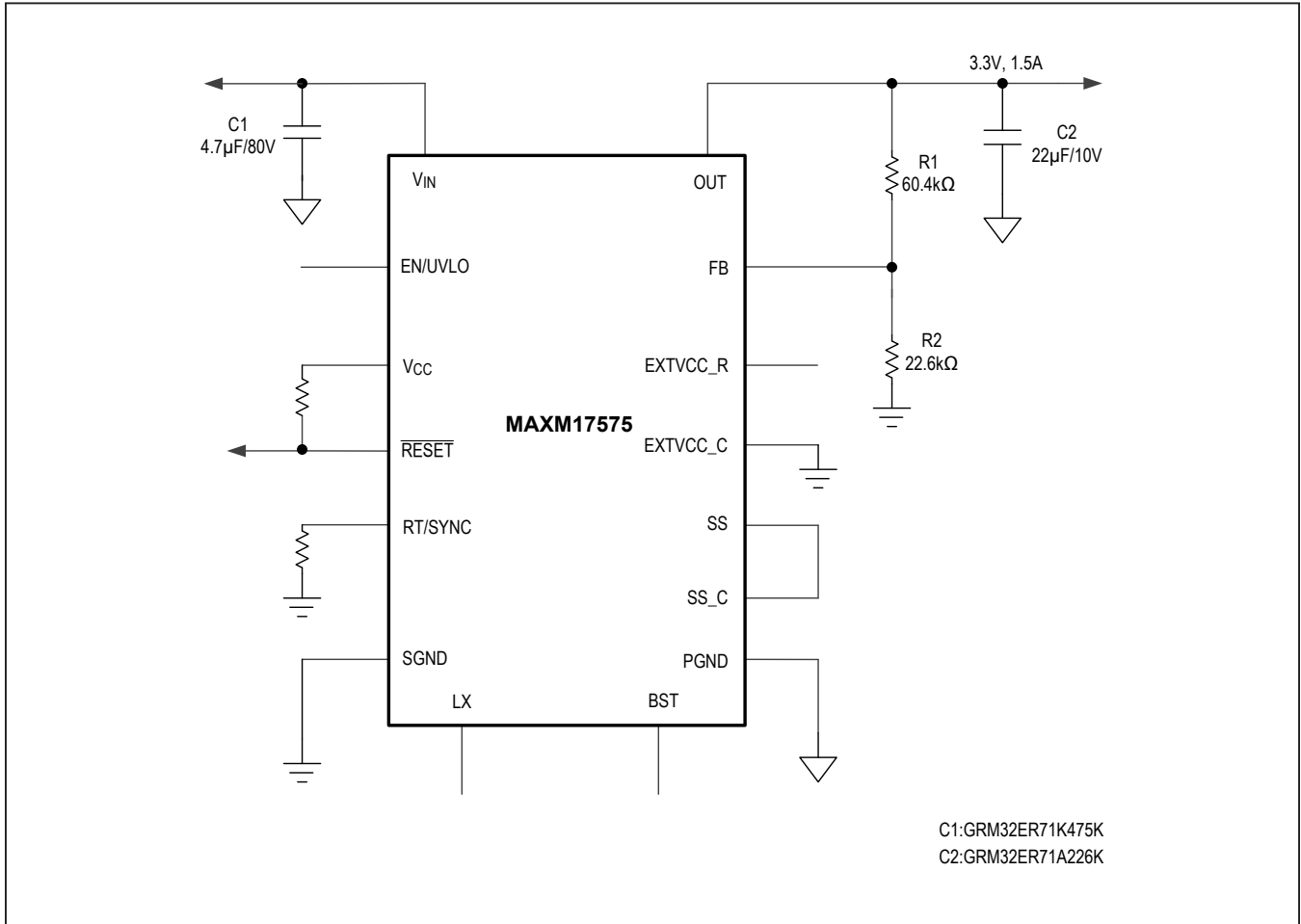

Ordering Information

PART	TEMP RANGE	PIN PACKAGE
MAXM17575ALI#	-40°C to +125°C	28-Pin SiP 6.5mm × 10mm × 2.92mm

Revision History

REVISION NUMBER	REVISION DATE	DESCRIPTION	PAGES CHANGED
0	6/17	Initial release	—
1	9/17	Updated <i>Package Information</i> table, <i>Ordering Information</i> table, and Table 1. Updated <i>External Frequency Synchronization (RT/SYNC)</i> , <i>Operating Input-Voltage Range</i> , <i>Thermal Fault Protection</i> , <i>Input-Capacitor Selection</i> , and <i>Output-Capacitor Selection</i> sections. Replaced <i>Typical Application Circuit</i> on first page, and <i>3.3V Output Typical Application Circuit</i> . Fixed typos.	1–2, 5, 8 10, 13, 15–17, 19, 21
2	4/19	Updated the <i>Benefits and Features</i> , <i>Electrical Characteristics</i> , and <i>Input Undervoltage-Lockout Level</i> sections; added TOC44–TOC45; replaced the <i>Overcurrent Protection (OCP)</i> and <i>Power Dissipation</i> sections	1, 3, 11, 16, 18, 19

For pricing, delivery, and ordering information, please visit Maxim Integrated's online storefront at <https://www.maximintegrated.com/en/storefront/storefront.html>.

Maxim Integrated cannot assume responsibility for use of any circuitry other than circuitry entirely embodied in a Maxim Integrated product. No circuit patent licenses are implied. Maxim Integrated reserves the right to change the circuitry and specifications without notice at any time. The parametric values (min and max limits) shown in the *Electrical Characteristics* table are guaranteed. Other parametric values quoted in this data sheet are provided for guidance.

Компания «Океан Электроники» предлагает заключение долгосрочных отношений при поставках импортных электронных компонентов на взаимовыгодных условиях!

Наши преимущества:

- Поставка оригинальных импортных электронных компонентов напрямую с производств Америки, Европы и Азии, а так же с крупнейших складов мира;
- Широкая линейка поставок активных и пассивных импортных электронных компонентов (более 30 млн. наименований);
- Поставка сложных, дефицитных, либо снятых с производства позиций;
- Оперативные сроки поставки под заказ (от 5 рабочих дней);
- Экспресс доставка в любую точку России;
- Помощь Конструкторского Отдела и консультации квалифицированных инженеров;
- Техническая поддержка проекта, помощь в подборе аналогов, поставка прототипов;
- Поставка электронных компонентов под контролем ВП;
- Система менеджмента качества сертифицирована по Международному стандарту ISO 9001;
- При необходимости вся продукция военного и аэрокосмического назначения проходит испытания и сертификацию в лаборатории (по согласованию с заказчиком);
- Поставка специализированных компонентов военного и аэрокосмического уровня качества (Xilinx, Altera, Analog Devices, Intersil, Interpoint, Microsemi, Actel, Aeroflex, Peregrine, VPT, Syfer, Eurofarad, Texas Instruments, MS Kennedy, Miteq, Cobham, E2V, MA-COM, Hittite, Mini-Circuits, General Dynamics и др.);

Компания «Океан Электроники» является официальным дистрибьютором и эксклюзивным представителем в России одного из крупнейших производителей разъемов военного и аэрокосмического назначения «**JONHON**», а так же официальным дистрибьютором и эксклюзивным представителем в России производителя высокотехнологичных и надежных решений для передачи СВЧ сигналов «**FORSTAR**».



JONHON

«**JONHON**» (основан в 1970 г.)

Разъемы специального, военного и аэрокосмического назначения:

(Применяются в военной, авиационной, аэрокосмической, морской, железнодорожной, горно- и нефтедобывающей отраслях промышленности)

«**FORSTAR**» (основан в 1998 г.)

ВЧ соединители, коаксиальные кабели,
кабельные сборки и микроволновые компоненты:

(Применяются в телекоммуникациях гражданского и специального назначения, в средствах связи, РЛС, а так же военной, авиационной и аэрокосмической отраслях промышленности).



Телефон: 8 (812) 309-75-97 (многоканальный)

Факс: 8 (812) 320-03-32

Электронная почта: ocean@oceanchips.ru

Web: <http://oceanchips.ru/>

Адрес: 198099, г. Санкт-Петербург, ул. Калинина, д. 2, корп. 4, лит. А