



## SinglFuse™ SF-2410FP-T Series Features

- Single blow fuse for overcurrent protection
- EIA 2410 (6125 metric) footprint
- Ceramic tube design for fast acting precision fusing speed applications
- UL 248-14 listed
- Surface mount packaging for automated assembly
- RoHS compliant\* and halogen free\*\*

## SF-2410FP-T Series – Fast Acting Precision SMD Fuses

### Electrical Characteristics

Model	Rated Current (A)	Fusing Time	Resistance (Ω) Typ.***	Rated Voltage	Interrupting Rating	Typical I <sup>2</sup> t (A <sup>2</sup> s)****	Certifications
							cUL
							E198545
SF-2410FP0062T-2	0.062	Open within 5 sec. at 200 % rated current	6.653	125 VAC	50 A @ 125 VAC 50 A @ 125 VDC 300 A @ 32 VDC	0.0012	✓
SF-2410FP008T-2	0.08		4.974			0.0017	✓
SF-2410FP010T-2	0.1		3.014			0.0043	✓
SF-2410FP0125T-2	0.125		2.044			0.0094	✓
SF-2410FP016T-2	0.16		0.8655			0.0116	✓
SF-2410FP020T-2	0.2		1.8535			0.0517	✓
SF-2410FP025T-2	0.25		1.119			0.0528	✓
SF-2410FP0315T-2	0.315		0.843			0.1365	✓
SF-2410FP0375T-2	0.375		0.732			0.1502	✓
SF-2410FP040T-2	0.4		0.4995			0.2149	✓
SF-2410FP050T-2	0.5		0.476			0.358	✓
SF-2410FP075T-2	0.75		0.2065			0.3761	✓
SF-2410FP100T-2	1		0.158			0.4143	✓
SF-2410FP150T-2	1.5		0.114			1.0606	✓
SF-2410FP200T-2	2		0.0605			1.08	✓
SF-2410FP250T-2	2.5		0.044			1.1471	✓
SF-2410FP300T-2	3		0.036			1.548	✓
SF-2410FP315T-2	3.15		0.033			2.6485	✓
SF-2410FP350T-2	3.5		0.029			2.695	✓
SF-2410FP400T-2	4		0.021			3.9744	✓
SF-2410FP500T-2	5	0.013	6.175	✓			
SF-2410FP700T-2	7	0.01	9.016	✓			
SF-2410FP800T-2	8	0.0085	16.758	✓			
SF-2410FP1000T-2	10	0.006	24.42	✓			

\*\*\* Resistance value measured with ≤10 % rated current at 25 °C ambient. Tolerance ±30 %.

\*\*\*\* Melting I<sup>2</sup>t calculated at 10 times rated current.



### WARNING Cancer and Reproductive Harm

[www.P65Warnings.ca.gov](http://www.P65Warnings.ca.gov)

\* RoHS Directive 2015/863, Mar 31, 2015 and Annex.

\*\* Bourns considers a product to be "halogen free" if (a) the Bromine (Br) content is 900 ppm or less; (b) the Chlorine (Cl) content is 900 ppm or less; and (c) the total Bromine (Br) and Chlorine (Cl) content is 1500 ppm or less.

"SinglFuse" is a trademark of Bourns, Inc.

Specifications are subject to change without notice. Users should verify actual device performance in their specific applications.

The products described herein and this document are subject to specific legal disclaimers as set forth on the last page of this document, and at [www.bourns.com/docs/legal/disclaimer.pdf](http://www.bourns.com/docs/legal/disclaimer.pdf).

## SinglFuse™ SF-2410FP-T Series Applications

- Notebooks
- LCD Monitors
- LCD Backlight Inverters
- POE, POE+
- PC Servers
- Power Supplies
- Game Consoles
- White Goods

## SF-2410FP-T Series – Fast Acting Precision SMD Fuses

**BOURNS®**

### Reliability Testing

No.	Test	Test Condition	Requirement	Test Reference
1	Solderability	Temperature setup: 235 ±5 °C Time setup: 10 ±1 sec.	After test terminal electrode wetting area must be greater than 95 %	IEC 60068-2-58
2	Resistance to soldering heat	Temperature setup: 235 ±5 °C Time setup: 30 ± 5 sec.	DCR change ≤ ±15 %	IEC 60068-2-58
3	Thermal shock	Temperature setup: 25 °C ~ -65 °C ~ 25 °C ~ 125 °C Time setup: -65 °C (30 min) ~ 25 °C (5 min) ~ 125 °C (30 min) ~ 25 °C (5 min), 5 cycles	DCR change ≤ ±15 % No mechanical damage	MIL-STD-202G Method 107G Test Condition B
4	Humidity unload	Heat (85 ±0.5 °C) High Humidity (85 ±1 % RH) 240 hours	DCR change ≤ ±15 % No mechanical damage	MIL-STD-202G Method 103B Test Condition A
5	Salt spray	Salt spray concentration: 5 ±1 % Test liquid temperature: 35 ±0.5 °C 96 hours	DCR change ≤ ±15 % No mechanical damage	MIL-STD-202G Method 101E Test Condition A
6	Bending	The board shall be bent by 1 mm at a rate of 1 mm/sec.	DCR change ≤ ±15 %	IEC 60127-4
7	Vibration	Frequency setup: 10 ~ 55 ~ 10 Hz Time setup: 1 Minute/cycle (X-Y-Z, 120 cycles, 6 hours)	DCR change ≤ ±15 % No mechanical damage	MIL-STD-202G Method 201A

### Environmental Characteristics

Operating Temperature..... -55 °C to +125 °C  
 Storage Conditions  
     Temperature ..... +15 °C to +30 °C  
     Humidity..... 20 % to 70 %  
     Shelf Life..... 2 years from manufacturing date  
 Moisture Sensitivity Level..... 1  
 ESD Classification (HBM)..... Class 6

### Agency Recognition

UL File Number ..... E198545

### Packaging Quantity

1,000 pieces per 7-inch reel

### Construction

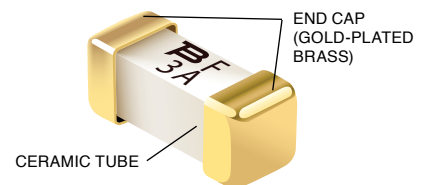

### How to Order

**SF - 2410 FP 0062 T - 2**

SinglFuse™ \_\_\_\_\_  
 Product Designator \_\_\_\_\_  
 SMD Footprint \_\_\_\_\_  
     2410 = EIA 2410  
     (6125 metric)  
 Fuse Blow Type \_\_\_\_\_  
     FP = Fast Acting Precision  
 Rated Current \_\_\_\_\_  
     0062 ~ 1000 (62 mA ~ 10 A)  
 Structure Type \_\_\_\_\_  
     T = Ceramic Tube  
 Packaging Type \_\_\_\_\_  
     - 2 = Tape & Reel

Specifications are subject to change without notice.

Users should verify actual device performance in their specific applications.

The products described herein and this document are subject to specific legal disclaimers as set forth on the last page of this document, and at [www.bourns.com/docs/legal/disclaimer.pdf](http://www.bourns.com/docs/legal/disclaimer.pdf).

# SF-2410FP-T Series – Fast Acting Precision SMD Fuses



## Typical Part Marking

Represents total content. Layout may vary.



Rated Current	Part Marking
62 mA	62 mA
80 mA	80 mA
100 mA	100 mA
125 mA	125 mA
160 mA	160 mA
200 mA	200 mA
250 mA	250 mA
315 mA	315 mA
375 mA	375 mA
400 mA	400 mA
500 mA	500 mA
750 mA	750 mA

Rated Current	Part Marking
1 A	1 A
1.5 A	1.5 A
2 A	2 A
2.5 A	2.5 A
3 A	3 A
3.15 A	3.15 A
3.5 A	3.5 A
4 A	4 A
5 A	5 A
7 A	7 A
8 A	8 A
10 A	10 A

## Product Dimensions

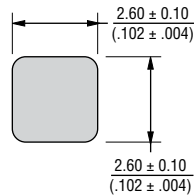
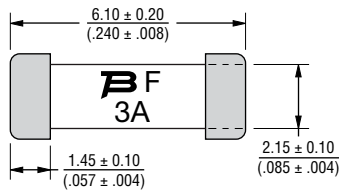

DIMENSIONS:  $\frac{\text{MM}}{\text{(INCHES)}}$

## Recommended Pad Layout

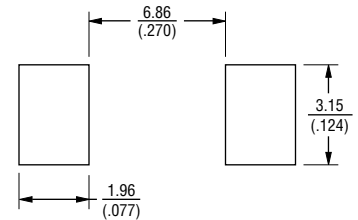

DIMENSIONS:  $\frac{\text{MM}}{\text{(INCHES)}}$

Specifications are subject to change without notice.

Users should verify actual device performance in their specific applications.

The products described herein and this document are subject to specific legal disclaimers as set forth on the last page of this document, and at [www.bourns.com/docs/legal/disclaimer.pdf](http://www.bourns.com/docs/legal/disclaimer.pdf).

Average Pre-Arcing Time vs. Current Curves

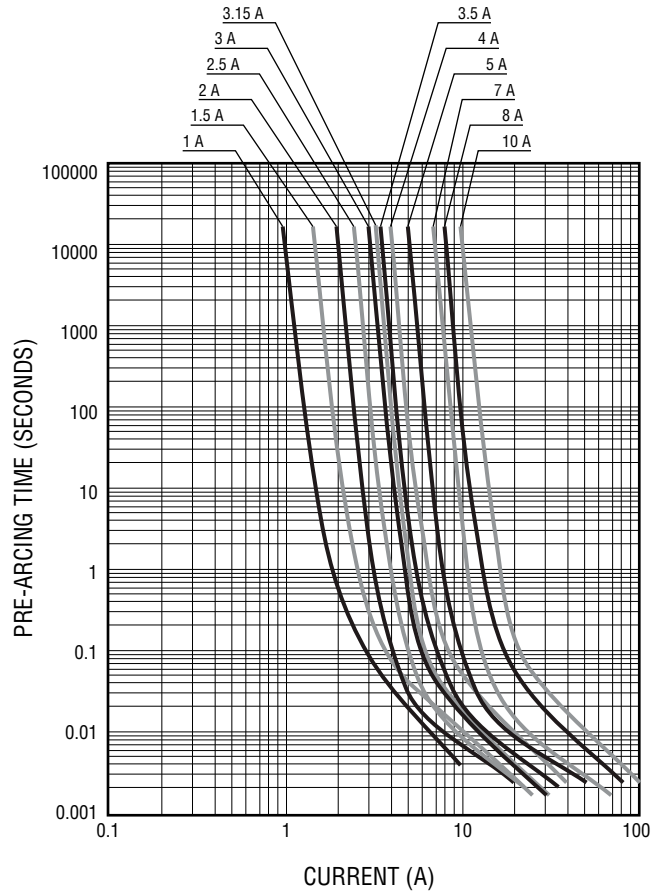

Average  $I^2t$  vs.  $t$  Curves

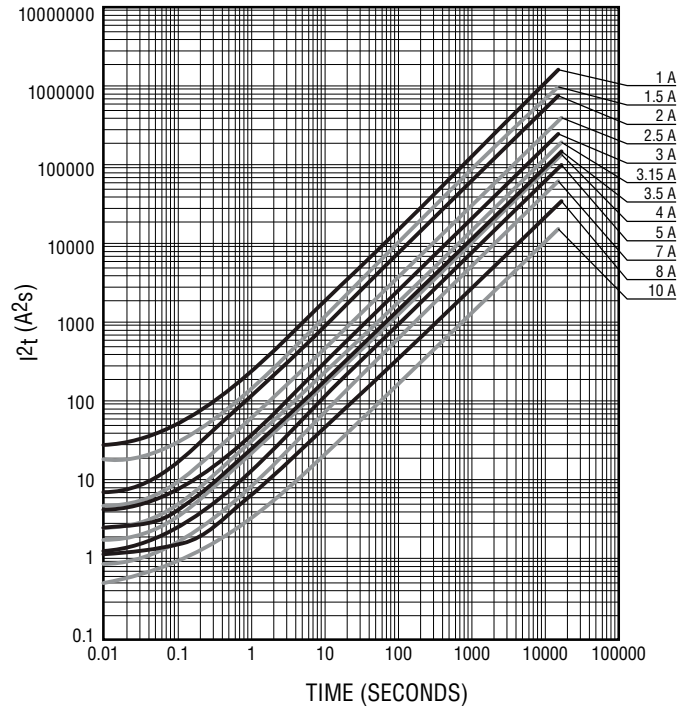

Specifications are subject to change without notice.

Users should verify actual device performance in their specific applications.

The products described herein and this document are subject to specific legal disclaimers as set forth on the last page of this document, and at [www.bourns.com/docs/legal/disclaimer.pdf](http://www.bourns.com/docs/legal/disclaimer.pdf).

## Solder Reflow Recommendations



Profile Feature	Pb-Free Assembly
Preheat / Soak: Temperature Min. ( $T_{smin}$ ) Temperature Max. ( $T_{smax}$ ) Time ( $t_s$ ) from ( $T_{smin}$ to $T_{smax}$ )	150 °C 200 °C 60~180 seconds
Ramp Up Rate ( $T_L$ to $T_p$ )	3 °C / second max.
Ramp Up Rate ( $T_{smax}$ to $T_L$ )	5 °C / second max.
Liquidous Temperature ( $T_L$ ) Time ( $t_L$ ) maintained above $T_L$	217 °C 60~90 seconds
Peak Package Body Temperature ( $T_p$ )	235 °C ± 5 °C
Time within 5 °C of actual peak temperature ( $T_p$ )	20~30 seconds*
Ramp Down Rate ( $T_p$ to $T_L$ )	6 °C / second max.
Time 25 °C to Peak Temperature	8 minutes max.
Do not exceed	240 °C

\* Tolerance for peak profile temperature ( $T_p$ ) is defined as a supplier minimum and a user maximum.

## Solder Wave Recommendations

Peak Temperature (Dwell Time)

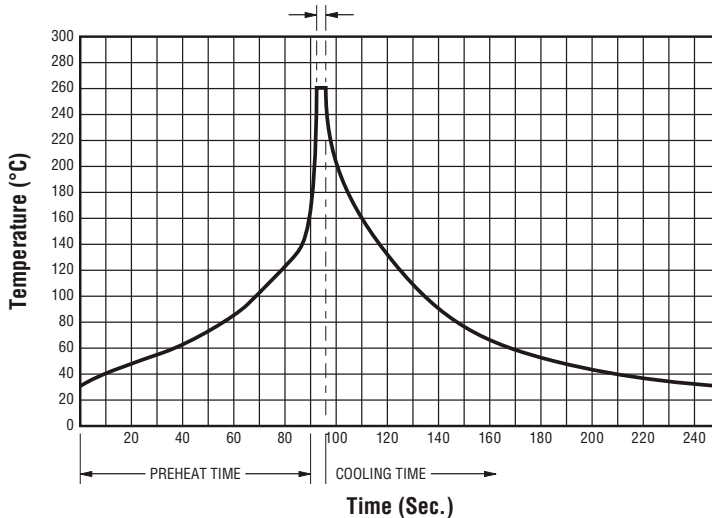

Profile Feature	Pb-Free Assembly
Preheat: Temperature Max. ( $T_{smax}$ ) Time (Min. to Max.)	150 °C 60~90 seconds
Solder Pot Temperature	260 °C max.
Solder Dwell Time	2~3 seconds

Specifications are subject to change without notice.

Users should verify actual device performance in their specific applications.

The products described herein and this document are subject to specific legal disclaimers as set forth on the last page of this document, and at [www.bourns.com/docs/legal/disclaimer.pdf](http://www.bourns.com/docs/legal/disclaimer.pdf).

**Current Rating Thermal Derating Curve**

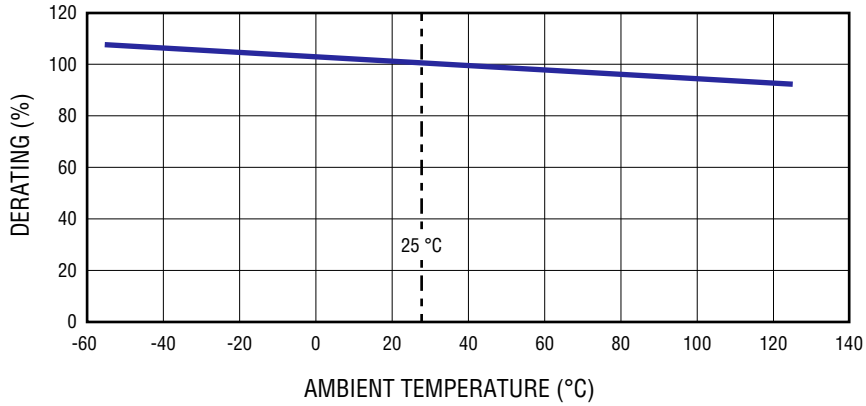

**Pulse Cycle Withstand Capability**



# SF-2410FP-T Series – Fast Acting Precision SMD Fuses

**BOURNS®**

## Packaging Specifications

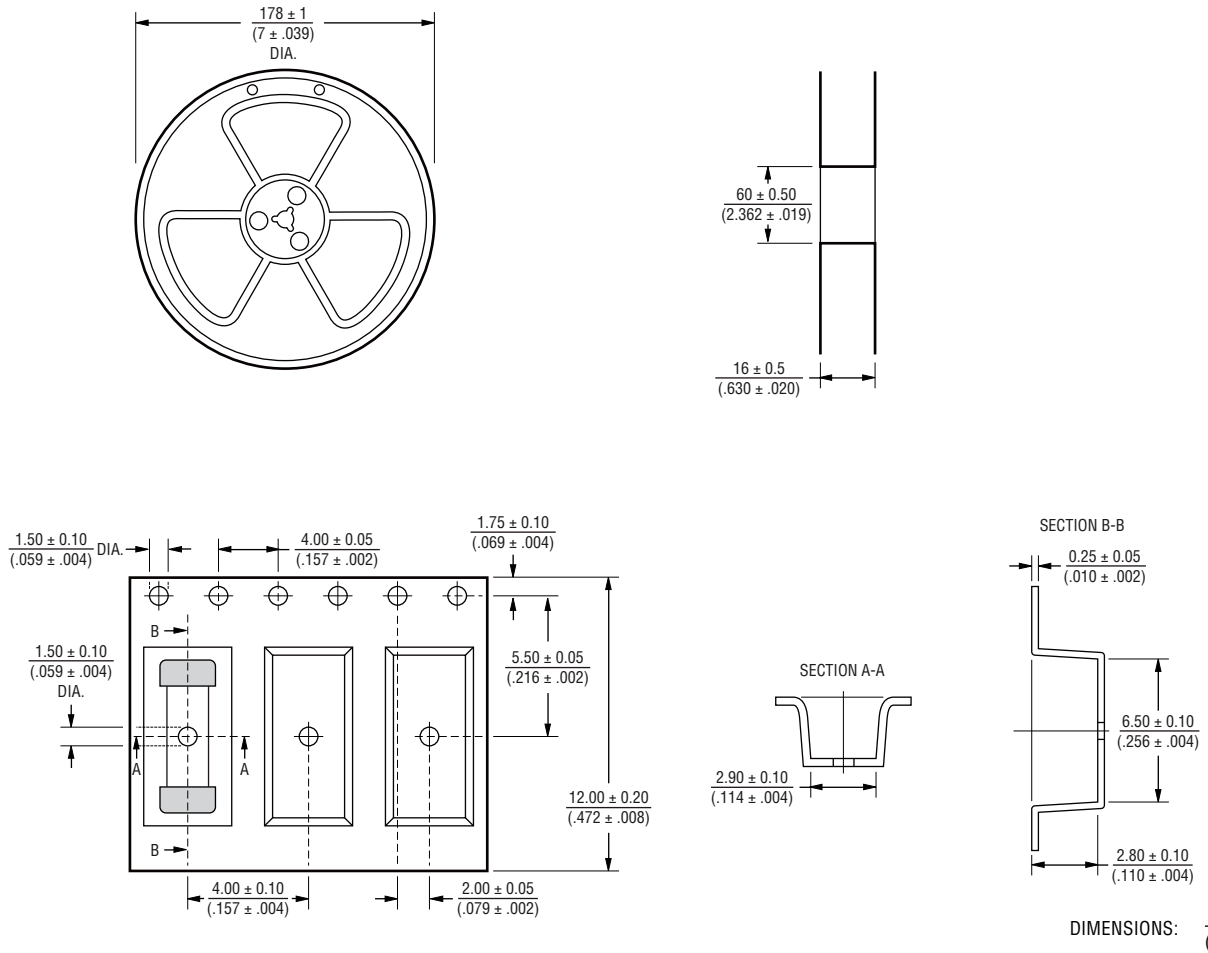

DIMENSIONS:  $\frac{\text{MM}}{\text{(INCHES)}}$

**BOURNS®**

Asia-Pacific: Tel: +886-2 2562-4117 • Email: asiacus@bourns.com  
 EMEA: Tel: +36 88 885 877 • Email: eurocus@bourns.com  
 The Americas: Tel: +1-951 781-5500 • Email: americus@bourns.com  
[www.bourns.com](http://www.bourns.com)

REV. 03/19

Specifications are subject to change without notice.

Users should verify actual device performance in their specific applications.

The products described herein and this document are subject to specific legal disclaimers as set forth on the last page of this document, and at [www.bourns.com/docs/legal/disclaimer.pdf](http://www.bourns.com/docs/legal/disclaimer.pdf).



This legal disclaimer applies to purchasers and users of Bourns® products manufactured by or on behalf of Bourns, Inc. and its affiliates (collectively, “Bourns”).

Unless otherwise expressly indicated in writing, Bourns® products and data sheets relating thereto are subject to change without notice. Users should check for and obtain the latest relevant information and verify that such information is current and complete before placing orders for Bourns® products.

The characteristics and parameters of a Bourns® product set forth in its data sheet are based on laboratory conditions, and statements regarding the suitability of products for certain types of applications are based on Bourns’ knowledge of typical requirements in generic applications. The characteristics and parameters of a Bourns® product in a user application may vary from the data sheet characteristics and parameters due to (i) the combination of the Bourns® product with other components in the user’s application, or (ii) the environment of the user application itself. The characteristics and parameters of a Bourns® product also can and do vary in different applications and actual performance may vary over time. Users should always verify the actual performance of the Bourns® product in their specific devices and applications, and make their own independent judgments regarding the amount of additional test margin to design into their device or application to compensate for differences between laboratory and real world conditions.

Unless Bourns has explicitly designated an individual Bourns® product as meeting the requirements of a particular industry standard (e.g., ISO/TS 16949) or a particular qualification (e.g., UL listed or recognized), Bourns is not responsible for any failure of an individual Bourns® product to meet the requirements of such industry standard or particular qualification. Users of Bourns® products are responsible for ensuring compliance with safety-related requirements and standards applicable to their devices or applications.

Bourns® products are not recommended, authorized or intended for use in nuclear, lifesaving, life-critical or life-sustaining applications, nor in any other applications where failure or malfunction may result in personal injury, death, or severe property or environmental damage. Unless expressly and specifically approved in writing by two authorized Bourns representatives on a case-by-case basis, use of any Bourns® products in such unauthorized applications might not be safe and thus is at the user’s sole risk. Life-critical applications include devices identified by the U.S. Food and Drug Administration as Class III devices and generally equivalent classifications outside of the United States.

Bourns expressly identifies those Bourns® standard products that are suitable for use in automotive applications on such products’ data sheets in the section entitled “Applications.” Unless expressly and specifically approved in writing by two authorized Bourns representatives on a case-by-case basis, use of any other Bourns® standard products in an automotive application might not be safe and thus is not recommended, authorized or intended and is at the user’s sole risk. If Bourns expressly identifies a sub-category of automotive application in the data sheet for its standard products (such as infotainment or lighting), such identification means that Bourns has reviewed its standard product and has determined that if such Bourns® standard product is considered for potential use in automotive applications, it should only be used in such sub-category of automotive applications. Any reference to Bourns® standard product in the data sheet as compliant with the AEC-Q standard or “automotive grade” does not by itself mean that Bourns has approved such product for use in an automotive application.

Bourns® standard products are not tested to comply with United States Federal Aviation Administration standards generally or any other generally equivalent governmental organization standard applicable to products designed or manufactured for use in aircraft or space applications. Bourns expressly identifies Bourns® standard products that are suitable for use in aircraft or space applications on such products’ data sheets in the section entitled “Applications.” Unless expressly and specifically approved in writing by two authorized Bourns representatives on a case-by-case basis, use of any other Bourns® standard product in an aircraft or space application might not be safe and thus is not recommended, authorized or intended and is at the user’s sole risk.

The use and level of testing applicable to Bourns® custom products shall be negotiated on a case-by-case basis by Bourns and the user for which such Bourns® custom products are specially designed. Absent a written agreement between Bourns and the user regarding the use and level of such testing, the above provisions applicable to Bourns® standard products shall also apply to such Bourns® custom products.

Users shall not sell, transfer, export or re-export any Bourns® products or technology for use in activities which involve the design, development, production, use or stockpiling of nuclear, chemical or biological weapons or missiles, nor shall they use Bourns® products or technology in any facility which engages in activities relating to such devices. The foregoing restrictions apply to all uses and applications that violate national or international prohibitions, including embargos or international regulations. Further, Bourns® products and Bourns technology and technical data may not under any circumstance be exported or re-exported to countries subject to international sanctions or embargoes. Bourns® products may not, without prior authorization from Bourns and/or the U.S. Government, be resold, transferred, or re-exported to any party not eligible to receive U.S. commodities, software, and technical data.

To the maximum extent permitted by applicable law, Bourns disclaims (i) any and all liability for special, punitive, consequential, incidental or indirect damages or lost revenues or lost profits, and (ii) any and all implied warranties, including implied warranties of fitness for particular purpose, non-infringement and merchantability.

*For your convenience, copies of this Legal Disclaimer Notice with German, Spanish, Japanese, Traditional Chinese and Simplified Chinese bilingual versions are available at:*

*Web Page:* <http://www.bourns.com/legal/disclaimers-terms-and-policies>

*PDF:* <http://www.bourns.com/docs/Legal/disclaimer.pdf>

Компания «Океан Электроники» предлагает заключение долгосрочных отношений при поставках импортных электронных компонентов на взаимовыгодных условиях!

Наши преимущества:

- Поставка оригинальных импортных электронных компонентов напрямую с производств Америки, Европы и Азии, а так же с крупнейших складов мира;
- Широкая линейка поставок активных и пассивных импортных электронных компонентов (более 30 млн. наименований);
- Поставка сложных, дефицитных, либо снятых с производства позиций;
- Оперативные сроки поставки под заказ (от 5 рабочих дней);
- Экспресс доставка в любую точку России;
- Помощь Конструкторского Отдела и консультации квалифицированных инженеров;
- Техническая поддержка проекта, помощь в подборе аналогов, поставка прототипов;
- Поставка электронных компонентов под контролем ВП;
- Система менеджмента качества сертифицирована по Международному стандарту ISO 9001;
- При необходимости вся продукция военного и аэрокосмического назначения проходит испытания и сертификацию в лаборатории (по согласованию с заказчиком);
- Поставка специализированных компонентов военного и аэрокосмического уровня качества (Xilinx, Altera, Analog Devices, Intersil, Interpoint, Microsemi, Actel, Aeroflex, Peregrine, VPT, Syfer, Eurofarad, Texas Instruments, MS Kennedy, Miteq, Cobham, E2V, MA-COM, Hittite, Mini-Circuits, General Dynamics и др.);

Компания «Океан Электроники» является официальным дистрибьютором и эксклюзивным представителем в России одного из крупнейших производителей разъемов военного и аэрокосмического назначения «JONHON», а так же официальным дистрибьютором и эксклюзивным представителем в России производителя высокотехнологичных и надежных решений для передачи СВЧ сигналов «FORSTAR».



## JONHON

«JONHON» (основан в 1970 г.)

Разъемы специального, военного и аэрокосмического назначения:

(Применяются в военной, авиационной, аэрокосмической, морской, железнодорожной, горно- и нефтедобывающей отраслях промышленности)

«FORSTAR» (основан в 1998 г.)

ВЧ соединители, коаксиальные кабели, кабельные сборки и микроволновые компоненты:

(Применяются в телекоммуникациях гражданского и специального назначения, в средствах связи, РЛС, а так же военной, авиационной и аэрокосмической отраслях промышленности).



Телефон: 8 (812) 309-75-97 (многоканальный)

Факс: 8 (812) 320-03-32

Электронная почта: [ocean@oceanchips.ru](mailto:ocean@oceanchips.ru)

Web: <http://oceanchips.ru/>

Адрес: 198099, г. Санкт-Петербург, ул. Калинина, д. 2, корп. 4, лит. А