

Programmable Controllers

CP1H/CP1L

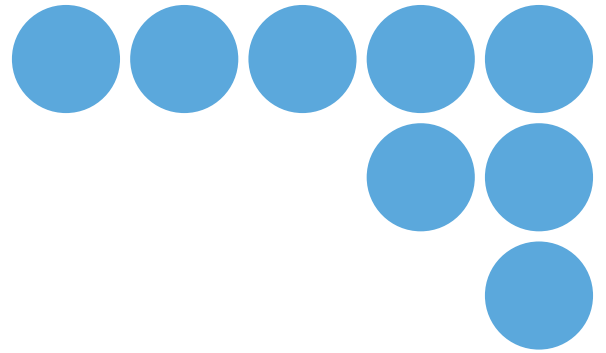

CP1H



CP1L-M

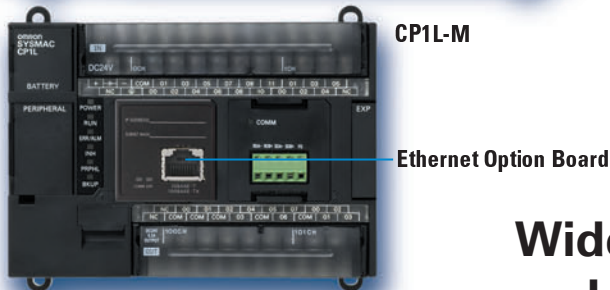

Ethernet Option Board



CP1L-L



CP1L-L

**Wide Lineup of CPU Units with
USB Port on All Models.
Multi-functionality Condensed
into One-package PLCs**

All in one Package

All-in-one Package PLCs with Condensed Multi-functionality.

A Wide Variety of Built-in Functions Expand Application Capabilities and Shorten the Design Time Required for the Growing Number and Increasing Complexity of Ladder Programs

Programmable Controllers

SYSMAC CP1H

The Ultimate High-performance Package-type PLC



Three types of CPU Unit are available to meet applications requiring advanced functionality:

- The CP1H-X with pulse outputs for 4 axes.
- The CP1H-Y with 1-MHz pulse I/O.
- The CP1H-XA with built-in analog I/O.

Programmable Controllers

SYSMAC CP1L

A Standard Package-type PLC



Complete with a standard-feature USB port, CP1L CPU Units are available for applications with as few as 10 I/O points. Whether you need simple sequence control or pulse I/O and a serial port, the CP1L PLCs give you an economical choice from among 10-, 14-, 20-, 30-, 40-, and 60-point CPU Units.

I/O Capacity,
Program Capacity,
Speed

Building-block PLCs

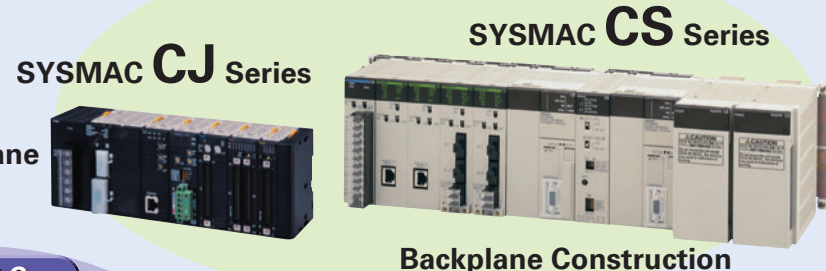

Package PLCs

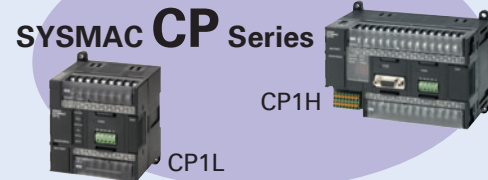

From small-scale to large-scale control, programs can be created incorporating function blocks (FB) and structured text (ST) using the same instructions and with the same easy operation.

Small-scale Control

Large-scale System Control

Complete Pulse and Serial Functions for Servo and Inverter Applications and Applications Using Programmable Terminals

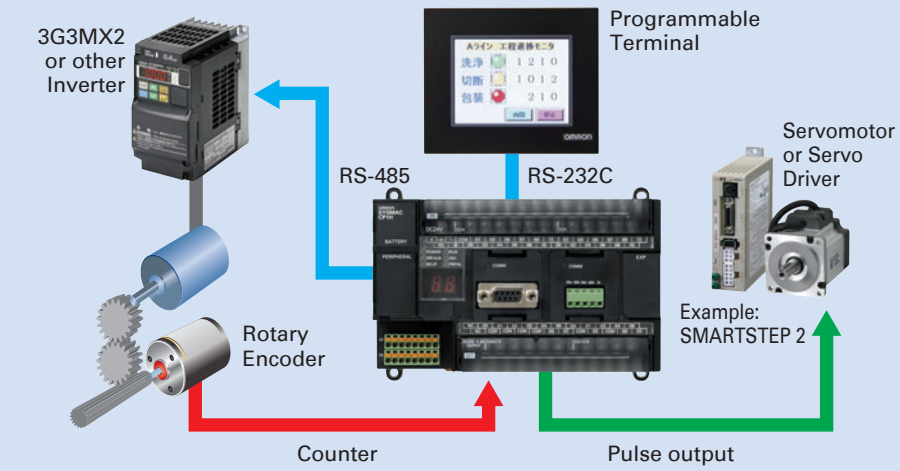

For positioning or communications, simply enter the set values for the instructions. Even complicated functions can be easily programmed using the OMRON Function Block (FB) Library.

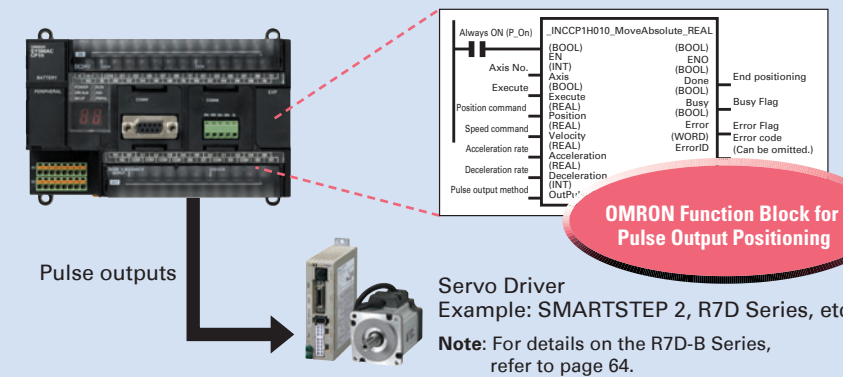

Easy Maintenance and Startup Adjustments with LCD Displays and Settings

Attach an LCD Option Board to the CPU Unit to easily monitor or change data values in the PLC to visually check error status.

CP1W-DAM01 LCD Option Board
The Board can be used only in the option board slot 1.



CP1H/CP1L
Cannot be used for the CP1L-L10.



USB Port Standard on all Models

A general-purpose USB cable keeps costs low, including the cable cost.

FA Integrated Tool Package
CX-One



- CP-series Lineup..... 4
- Expandability Applications..... 6
- CPU Units..... 8
- Expansion Units..... 10
- Functions.....12
 - Pulse Outputs.....12
 - High-speed Counters.....14
 - Inverter Positioning.....15
 - Serial Communications..... 16
 - Ethernet Communications...18
 - Analog I/O.....19
 - USB Peripheral Port.....20
 - LCD Displays and Settings...21
- Support Software.....22
- CPU Unit Functions..... 24
- Connecting Expansion Unit and Expansion I/O Units..... 26
- CPU Unit Specifications.....28
- Option Unit Specifications...43
- Expansion I/O Unit Specifications..... 44
- Expansion Unit Specifications..... 46
- Dimensions.....48
- Instructions..... 51
- Ordering Information.....55
- OMRON Function Block Library..... 62
- SMARTSTEP 2 AC Servo Drivers with Pulse String Inputs..... 64

A Wide Range of CPU Units Allows You to Select the Ideal Model.

Program capacity
Processing speed

A program capacity of 20K steps and 0.1 μs high-speed processing provide multi-axis, high-speed positioning control or analog control. CJ-series Special I/O Units and CPU Bus Units can also be used.

CP1H Series

A Choice of Three Types of CP1H CPU Unit Lets You Select the Functions You Need.

	High-speed Positioning CP1H-Y CPU Units	Built-in Analog I/O CP1H-XA CPU Units	Standard Type CP1H-X CPU Units
Pulse Outputs for 4 Axes	Two axes at 1 MHz and two axes at 100 kHz	Four axes at 100 kHz	
High-speed Counters for 4 Axes	Two axes at 1 MHz for single-phase (500 kHz for differential phases) and two axes at 100 kHz for single-phase (50 kHz for differential phases)	Four axes at 100 kHz for single-phase (50 kHz for differential phases)	
Built-in Analog I/O		Four analog inputs and two analog outputs	
Serial Communications	RS-232C Option Board	RS-422A/485 Option Board Up to two Option Boards can be mounted.	
Ethernet Communications	Ethernet Option Board	Two Ethernet Option Boards can be mounted.	
LCD Display Settings	LCD Option Board	One LCD Option Board can be mounted in option board slot 1.	

• Program capacity
20K steps
• Processing speed
0.1 μs
(basic instructions)

• Program capacity
10K steps
• Processing speed
0.55 μs
(basic instructions)

Basic package PLCs with serious functions from simple sequence control to 2-axis positioning control.

CP1L Series



• Program capacity
5K steps
• Processing speed
0.55 μs
(basic instructions)

10 points

14 points

20 points

30 points

40 points

60 points

I/O capacity

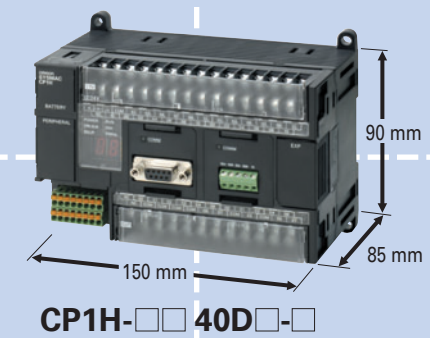

CP1H-□□ 40D□-□

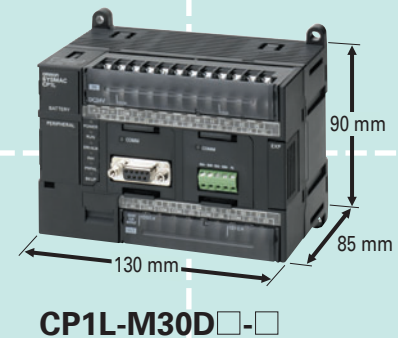

CP1L-M30D□-□



CP1L-M40D□-□

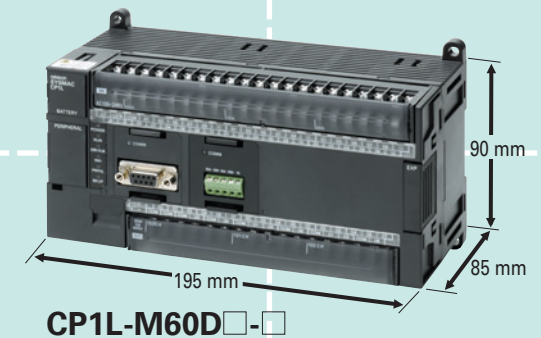

CP1L-M60D□-□

- Pulse Outputs**
Four-axis control is a standard feature.
- Counters**
Four-axis differential-phase control is a standard feature.
- USB Peripheral Port**
Another standard feature.
- Serial Communications**
Two ports. Select Option Boards for either RS-232C or RS-485 communications.
- Ethernet Communications**
Enabled by using an Option Board.
- LCD Displays and Settings**
Enabled using Option Board.
- Built-in Analog I/O**
XA CPU Units provide 4 input words and 2 output words.

- Pulse Outputs**
Two-axis control at 100 kHz is a standard feature.
- Counters with 2-axis differential-phase control**
are standard features.
Single-phase: 4 axes at 100 kHz
- USB Peripheral Port**
Another standard feature.
- Serial Communications**
Two ports (See note.). Select Option Boards for either RS-232C or RS-485 communications.
Note: CP1L-L CPU Units with 14 and 20 points support only one port. Cannot be used for the CP1L-L10.
- Ethernet Communications**
Enabled by using an Option Board.
Note: Cannot be used for the CP1L-L10.
- LCD Displays and Settings**
Enabled using Option Board. (See note.)
Note: Cannot be used for the CP1L-L10.

Expansion Units Provide for a Wider Range of Applications.

Programmable Controllers SYSMAC CP1H

● Using Only CP1W Units with the CP1H

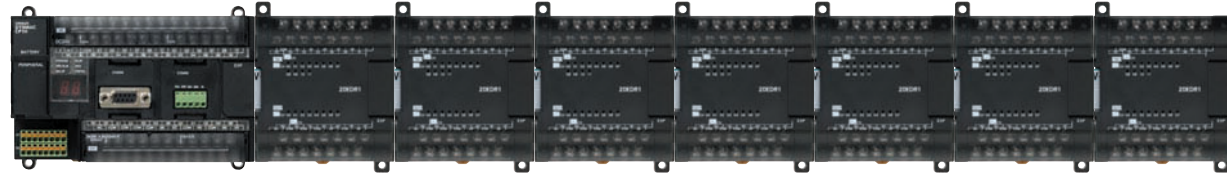

- Up to 7 CP1W/CPM1A Expansion Units and Expansion I/O Units can be connected.
- Note: Some Expansion Units and Expansion I/O Units have certain restrictions on use. (For details, refer to page 24.)

● Using CJ-series Special I/O Units, CJ-series CPU Bus Units, and CP1W Units with the CP1H

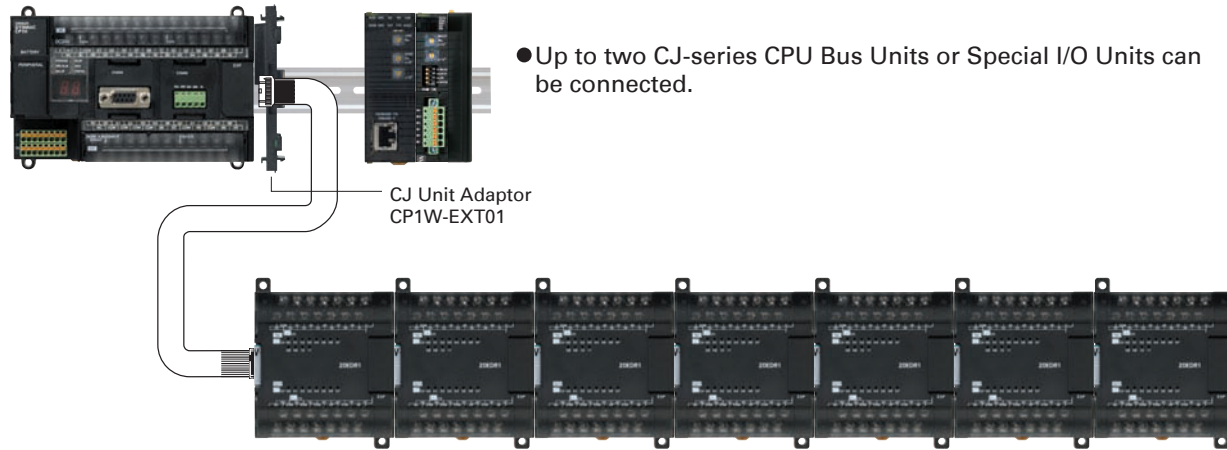

- Up to two CJ-series CPU Bus Units or Special I/O Units can be connected.
- Up to 7 CP1W/CPM1A Expansion Units and Expansion I/O Units can be connected.
- CP1W/CPM1A Expansion Units and Expansion I/O Units and CJ Units can be used simultaneously. CP1W-CN811 I/O Connecting Cable is required.

■ CP1H Application Examples

<p>Built-in Analog I/O: 4 Analog Inputs and 2 Analog Outputs</p> <p>Forming Machine</p> <p>CP1H-XA CPU Unit Temperature Sensor Unit</p> <p>4 analog inputs and 2 analog outputs Hydraulic pressure control</p>	<p>Four-axis, 1-MHz High-speed Pulse Outputs</p> <p>Electronic Parts Assembly Machine</p> <p>Capacitor picking Process depth Process positioning Rotation (final positioning)</p> <p>CP1H-Y CPU Unit</p> <p>Pulse outputs Positioning control via Servomotors</p>	<p>4-axis, 1-MHz High-speed Counters</p> <p>Spinning Machine</p> <p>High-speed counters Thread winding speed and length control</p> <p>CP1H-Y CPU Unit</p>
---	---	--

Programmable Controllers SYSMAC CP1L

● CP1L-M30D□-□/CP1L-M40D□-□/CP1L-M60D□-□

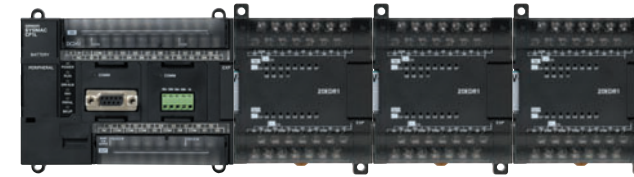

- Up to three CP1W/CPM1A Expansion Units and Expansion I/O Units can be connected.

● CP1L-L14D□-□/CP1L-L20D□-□

Note: Cannot be used for the CP1L-L10.



- One CP1W/CPM1A Expansion Unit or Expansion I/O Unit can be connected.

■ CP1H/CP1L Communications Interface Options











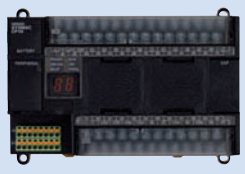

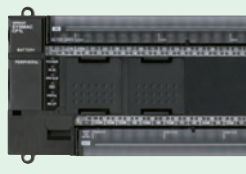
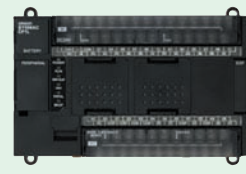
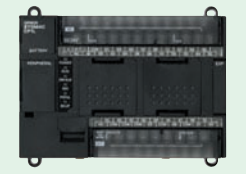







<p>Two Optional Serial Ports</p> <p>Two Optional Ethernet Ports</p>	<p>Option Boards</p> <p>RS-232C Interface CP1W-CIF01 RS-422A/485 Interface CP1W-CIF11 RS-422A/485 (Isolated-type) Interface CP1W-CIF12 Ethernet Interface CP1W-CIF41</p> <p>Two types of communications are available. Either two RS-232C ports, two RS-422A/485 ports or two Ethernet ports can be used.</p> <p>Note: 1. Only one board is supported by CP1L-L CPU Units (14 or 20 points). Cannot be used for the CP1L-L10. 2. When using CP1W-CIF41 Ver.1.0, one Ethernet port can be added.</p>
---	---

Standard Feature: USB peripheral port

■ CP1L Application Examples

<p>Two-axis Pulse Outputs</p> <p>Packing Machine</p> <p>CP1L</p> <p>Pulse outputs Sheet feeding control via Servomotors</p>	<p>Sequence Control</p> <p>Air Cleaner Control</p> <p>CP1L</p> <p>Analog Output Unit Cleaner fan motor control (Inverter)</p>	<p>Sequence Control with Clock Function</p> <p>Shopping Mall Fountain Control</p> <p>CP1L</p>
---	---	---

Maximize Efficiency by Selecting the Optimum CPU Unit for Your Applications.

	CP1H			CP1L						
	Y CPU Units	XA CPU Units	X CPU Units	M Type 60 Points	M Type 40 Points	M Type 30 Points	L Type 20 Points	L Type 14 Points	L Type 10 Points	
										
	CP1H-Y20DT-D DC power supply, 12 DC inputs, 8 transistor (sinking) outputs, Two line-driver inputs	CP1H-XA40DR-A AC power supply, 24 DC inputs, 16 relay outputs, 4 analog inputs, 2 analog outputs CP1H-XA40DT-D DC power supply, 24 DC inputs, 16 transistor (sinking) outputs, 4 analog inputs, 2 analog outputs CP1H-XA40DT1-D DC power supply, 24 DC inputs, 16 transistor (sourcing) outputs, 4 analog inputs, 2 analog outputs	CP1H-X40DR-A AC power supply, 24 DC inputs, 16 relay outputs CP1H-X40DT-D DC power supply, 24 DC inputs, 16 transistor (sinking) outputs CP1H-X40DT1-D DC power supply, 24 DC inputs, 16 transistor (sourcing) outputs	CP1L-M60DR-A AC power supply, 36 DC inputs, 36 DC inputs, 24 relay outputs CP1L-M60DT-A AC power supply, 36 DC inputs, 24 transistor (sinking) outputs CP1L-M60DR-D DC power supply, 36 DC inputs, 24 relay outputs CP1L-M60DT-D DC power supply, 36 DC inputs, 24 transistor (sinking) outputs CP1L-M60DT1-D DC power supply, 36 DC inputs, 24 transistor (sourcing) outputs	CP1L-M40DR-A AC power supply, 24 DC inputs, 16 relay outputs CP1L-M40DT-A AC power supply, 24 DC inputs, 16 transistor (sinking) outputs CP1L-M40DR-D DC power supply, 24 DC inputs, 16 relay outputs CP1L-M40DT-D DC power supply, 24 DC inputs, 16 transistor (sinking) outputs CP1L-M40DT1-D DC power supply, 24 DC inputs, 16 transistor (sourcing) outputs	CP1L-M30DR-A DC power supply, 18 DC inputs, 12 relay outputs CP1L-M30DT-A AC power supply, 18 DC inputs, 12 transistor (sinking) outputs CP1L-M30DR-D DC power supply, 18 DC inputs, 12 relay outputs CP1L-M30DT-D DC power supply, 18 DC inputs, 12 transistor (sinking) outputs CP1L-M30DT1-D DC power supply, 18 DC inputs, 12 transistor (sourcing) outputs	CP1L-L20DR-A AC power supply, 12 DC inputs, 8 relay outputs CP1L-L20DT-A AC power supply, 12 DC inputs, 8 transistor (sinking) outputs CP1L-L20DR-D DC power supply, 12 DC inputs, 8 relay outputs CP1L-L20DT-D DC power supply, 12 DC inputs, 8 transistor (sinking) outputs CP1L-L20DT1-D DC power supply, 12 DC inputs, 8 transistor (sourcing) outputs	CP1L-L14DR-A AC power supply, 8 DC inputs, 6 relay outputs CP1L-L14DT-A AC power supply, 8 DC inputs, 6 transistor (sinking) outputs CP1L-L14DR-D DC power supply, 8 DC inputs, 6 relay outputs CP1L-L14DT-D DC power supply, 8 DC inputs, 6 transistor (sinking) outputs CP1L-L14DT1-D DC power supply, 8 DC inputs, 6 transistor (sourcing) outputs	CP1L-L10DR-A AC power supply, 6 DC inputs, 4 relay outputs CP1L-L10DT-A AC power supply, 6 DC inputs, 4 transistor (sinking) outputs CP1L-L10DR-D DC power supply, 6 DC inputs, 4 relay outputs CP1L-L10DT-D DC power supply, 6 DC inputs, 4 transistor (sinking) outputs CP1L-L10DT1-D DC power supply, 6 DC inputs, 4 transistor (sourcing) outputs	
 Pulse outputs (only for transistor outputs)	1 MHz for two axes (line driver outputs), 100 kHz for two axes (four axes total)			100 kHz for two axes						
 Counters	1 MHz (single-phase), 500 kHz (differential phases) for two axes (line driver outputs), 100 kHz (single-phase), 50 kHz (differential phases) for two axes (four axes total)			100 kHz (single-phase) for four axes, or 50 kHz (differential phases) for two axes						
 Serial communications	Two serial ports can be added as options (either RS-232C or RS-422A/485 Option Boards).			Two optional serial ports can be added (either RS-232C or RS-422A/485 Option Boards).			One optional serial port can be added (either an RS-232C or RS-422A/485 Option Board).		—	
 Ethernet communications	Two Ethernet ports can be added as an option. When using CP1W-CIF41 Ver.1.0, one Ethernet port can be added.			Two Ethernet ports can be added as an option. When using CP1W-CIF41 Ver.1.0, one Ethernet can be added.			One Ethernet port can be added as an option.		—	
 USB peripheral port	Yes	Yes	Yes	Yes	Yes	Yes	Yes	Yes	Yes	
 Built-in analog I/O	—	4 analog inputs and 2 analog outputs (resolution: 6,000 or 12,000)		—	—	—	—	—	—	
 Memory Cassette	Yes	Yes	Yes	Yes	Yes	Yes	Yes	Yes	Yes	
 LCD display settings	An LCD Option Board can be added as an option to option board slot 1.			An LCD Option Board can be added as an option to option board slot 1.			An LCD Option Board can be added as an option to option board slot 1.		—	
 Function blocks (ladder diagrams or ST language)	Yes	Yes	Yes	Yes	Yes	Yes	Yes	Yes	Yes	
 Inverter positioning	—	—	—	Yes	Yes	Yes	Yes	Yes	Yes	
 7-segment display	Yes	Yes	Yes	—	—	—	—	—	—	
 Program capacity	20K steps			10K steps			5K steps			
 Data memory capacity	32K words			32K words			10K words			
 High-speed processing	0.1 μs/LD instruction, 0.3 μs/MOV instruction			0.55 μs/LD instruction, 1.84 μs/MOV instruction						

Option Boards

Options



■ RS-232C Option Board CP1W-CIF01



■ RS-422A/485 Option Board CP1W-CIF11



■ RS-422A/485 (Isolated-type) Option Board CP1W-CIF12

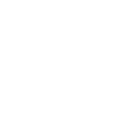

■ Ethernet Option Board CP1W-CIF41



■ LCD Option Board CP1W-DAM01



■ Memory Cassette CP1W-ME05M

CP1H and CP1L

Expansion I/O Units



■ CP1W-8ED
● 8 DC inputs



■ CP1W-16ER
● 16 relay outputs



■ CP1W-20EDR1
● 12 DC inputs
● 8 relay outputs

■ CP1W-8ER
● 8 relay outputs

■ CP1W-16ET
● 16 transistor outputs (sinking)

■ CP1W-20EDT
● 12 DC inputs
● 8 transistor outputs (sinking)

■ CP1W-8ET
● 8 transistor outputs (sinking)

■ CP1W-16ET1
● 16 transistor outputs (sourcing)

■ CP1W-20EDT1
● 12 DC inputs
● 8 transistor outputs (sourcing)

■ CP1W-8ET1
● 8 Transistor outputs (sourcing)



■ CP1W-32ER
● 32 relay outputs



■ CP1W-40EDR
● 24 DC inputs
● 16 relay outputs

■ CP1W-32ET
● 32 transistor outputs (sinking)

■ CP1W-40EDT
● 24 DC inputs
● 16 transistor outputs (sinking)

■ CP1W-32ET1
● 32 transistor outputs (sourcing)

■ CP1W-40EDT1
● 24 DC inputs
● 16 transistor outputs (sourcing)

Analog Units



■ Analog Input Unit CP1W-AD041
● Analog inputs: 4 (resolution: 6,000)



■ Analog Output Unit CP1W-DA041
● Analog outputs: 4 (resolution: 6,000)

■ CP1W-DA021 **NEW**
● Analog outputs: 2 (resolution: 6,000)



■ Analog I/O Unit CP1W-MAD11
● Analog inputs: 2 (resolution: 6,000)
● Analog outputs: 1 (resolution: 6,000)

Temperature Sensor Unit



■ Temperature Sensor Unit CP1W-TS001

- Thermocouple inputs: 2 CP1W-TS002
- Thermocouple inputs: 4



■ Temperature Sensor Unit CP1W-TS101

- Platinum-resistance thermometer inputs: 2 CP1W-TS102
- Platinum-resistance thermometer inputs: 4

CompoBus/S I/O Link Unit



■ CompoBus/S I/O Link Unit CP1W-SRT21

- Inputs: 8
- Outputs: 8

I/O Connecting Cable



■ CP1W-CN811 I/O Connecting Cable: 80 cm

Note: CP1W/CPM1A Expansion Units include I/O Connection Cables (in lengths of approx. 6 cm) for side-by-side connection.

CPM1A Expansion Unit and Expansion I/O Units

CPM1A Expansion Unit and Expansion I/O Units can be used with CP1H or CP1L CPU Units under the same conditions as for the CP1W.

CP1H Only

CJ-series Special I/O Units and CPU Bus Units

Up to two CJ-series Special I/O Units or CPU Bus Units can be connected by using a CJ Unit Adaptor. Refer to page 27 for the Units that can be used. For details on CJ-series Units, refer to the *CJ1 Catalog* (Cat. No. P052).

CJ Unit Adaptor



CP1W-EXT01 (with End Cover)

Special I/O Units



Analog Input Units CJ1W-AD042 CJ1W-AD041-V1 CJ1W-AD081-V1 (4 or 8 points)



Analog Output Units CJ1W-DA042V CJ1W-DA021/041 CJ1W-DA08V/08C (2, 4, or 8 points)



Analog I/O Unit CJ1W-MAD42 (4 analog inputs, 2 analog outputs)



Process Input Units CJ1W-PH41U CJ1W-AD04U CJ1W-PTS51/52 CJ1W-PTS15/16 CJ1W-PDC15



Temperature Control Units CJ1W-TCC000 (4 or 2 loops)

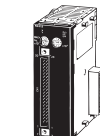

Position Control Units CJ1W-NC003 (1 to 4 axes)



High-speed Counter Unit CJ1W-CT021 (2 axes)



ID Sensor Units CJ1W-V680C1 CJ1W-V600C1 (1 or 2 Heads)

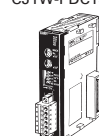

CompoBus/S Master Unit CJ1W-SRM21



CompoNet Master Unit CJ1W-CRM21

CPU Bus Units



Position Control Unit with MECHATROLINK-II Communications CJ1W-NC271 (2 axes) CJ1W-NC471 (4 axes) CJ1W-NCF71 (16 axes) CJ1W-NCF71-MA (16 axes)



Motion Control Unit with MECHATROLINK-II Communications CJ1W-MCH71 (30 axes)

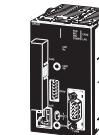

SYSMAC SPU High-speed Data Collection Unit CJ1W-SPU01-V2

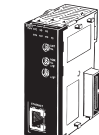

Ethernet Unit CJ1W-ETN21 (100Base-TX)



Serial Communications Units CJ1W-SCU42/SCU41-V1 (RS-232C and RS-422/485 ports) CJ1W-SCU22/SCU21-V1 (Two RS-232C ports) CJ1W-SCU32/SCU31-V1 (Two RS-422/485 ports)



Controller Link Unit CJ1W-CLK23



FL-Net Unit CJ1W-FLN22 (100Base-TX)



DeviceNet Unit CJ1W-DRM21



EtherNet/IP Unit CJ1W-EIP21

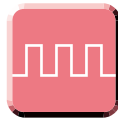

Pulse Outputs

Up to Four Axes Are Standard.

Advanced Power for High-precision Positioning Control.

Positioning for Electronic Component Manufacturing Equipment

Sheet Feeding for Vertical Pillow Packer

CP1H

● **Pulse Output Function for Up to Four Axes.**
Along with greater precision and more flexibility in multi-product manufacturing, high-speed multi-axis pulse output control responds to the increase in servo applications.

Pulse outputs

● **Example: Four-axis Control in Electronic Component Manufacturing Equipment**

Capacitor removal

Processing depth

Processing positioning

Rotation (final positioning)

Servo Drivers

Servomotors

A Full Range of Functions

■ Origin Search Function (ORG Instruction)

Origin searches are possible with a single ORG instruction.

■ Positioning with Trapezoidal Acceleration and Deceleration (PLS2 Instruction)

Easily achieved with special positioning instruction (PLS2).

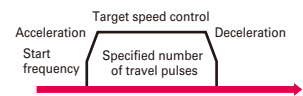

S-curve acceleration/ deceleration can be used to reduce vibration in high-speed positioning.



■ Interrupt Feeding (ACC and PLS2 Instructions)

Feed Control for Packing Material

Speed control (ACC instruction) Stop after output of set number of pulses

PLS2 executed

The packing material is fed and stopped at a fixed position after the seal mark is detected.

Applicable CPU Units and Functions

CP1H-Y CPU Unit



1 MHz for 2 axes and 100 kHz for 2 axes, for a total of 4 axes

CP1H-X CPU Unit



100 kHz for 4 axes

CP1L CPU Unit



100 kHz for 2 axes



Programming Is Made Easy Using OMRON Function Blocks

Note: For a list of function blocks in the OMRON Function Block Library, refer to page 62.

■ Just use the CX-Programmer to paste function blocks into the ladder program.

1 Start the CX-Programmer and right-click "Function Block" in the tree to select the required library file.

2 Use a function block call to select the desired OMRON Function Block.

3 An instance of the function block will be created in the ladder program.

■ Just insert set values into the OMRON Function Block.

● Example: Using Positioning OMRON Function Block

Start trigger Bit B Bit D Bit A

Always ON (P-On)

Axis No. 80

Pulse output 0: 80

Position command 200,000 pulses: +200,000.0

Speed command 50,000 Hz: +50,000.0

Acceleration rate 100 Hz/4 ms: +100.0

Deceleration rate 100 Hz/4 ms: +100.0

Pulse output method CW/CCW: 80

OutPulseSelect

EN (BOOL)

ENO (BOOL)

Axis (BOOL)

Done (BOOL)

Bit B (BOOL)

Execute (BOOL)

Busy (BOOL)

Error Flag (BOOL)

Position (REAL)

Velocity (REAL)

Acceleration (REAL)

Deceleration (REAL)

Interrupt (INT)

Error (WORD)

ErrorID (ErrorID)

End positioning

Bit B

Busy Flag

Bit C

Error Flag

Bit D

Error code

ErrorID (Can be omitted.)

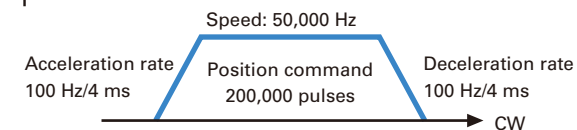

● Using Interrupt Feeding OMRON Function Block

Start trigger Bit B Bit D Bit A

Always ON (P-On)

Axis No. 80

Pulse output 0: 80

Interrupt input selection 0.00

Interrupt feeding amount 200,000 pulses: +200,000.0

Speed command .1 5,000 Hz: +5,000.0

Speed command - 2 1,000 Hz: +1,000.0

Acceleration rate 100 Hz/4 ms: +100.0

Deceleration rate 100 Hz/4 ms: +100.0

Pulse output method CW/CCW method: 80

EN (BOOL)

ENO (BOOL)

Axis (INT)

Done (BOOL)

Bit A (BOOL)

Execute (BOOL)

Status (BOOL)

Busy (BOOL)

InterruptSelect (DINT)

InterruptPosition (DINT)

Error (WORD)

ErrorID (ErrorID)

End positioning

Bit B

Operating status

D10 Processing Flag

Bit C

Busy

Error Flag

Contact D

Error Flag

ErrorID (Can be omitted.)

Interrupt Task 140

Interrupt input 0 (0.00)

Always ON (P-On)

PRV(881)

#0000

#0000

DO

Reads High-speed Counter PV.

Port designation

Control data

Rightmost word of output destination

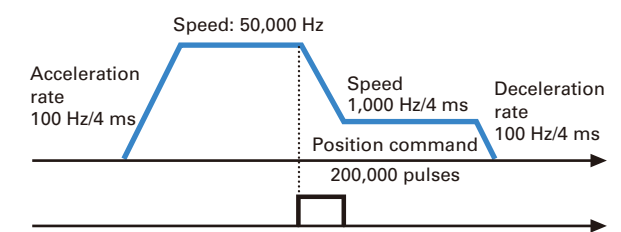

Interrupt input signal 00 (Input word 0, bit 00)

CP1H/CP1L

Servo Driver

Pulse output CW/CCW

SMARTSTEP 2, R7D Series, Etc.

A positioning OMRON Function Block for the CP1H is used in the above application example. The positioning OMRON Function Blocks for the CP1L are the same as the positioning OMRON Function Blocks for the CJ1M-CPU21/22/23.



High-speed Counters

Differential Phases for Up to Four Axes Are Standard. Easily Handles Multi-axis Control with a Single Unit.

Main-axis Control for Equipment Such as Textile Machinery or Spinning Machinery

Positioning Conveyance for Equipment Such as Building Material Manufacturing Machinery and Stone-cutting Machinery

● Four-axis Counter Function (Single-phase or Differential Phases)

Multi-axis counter inputs enable calculations for inverter positioning, spindle speed control in textile manufacturing, and much more.

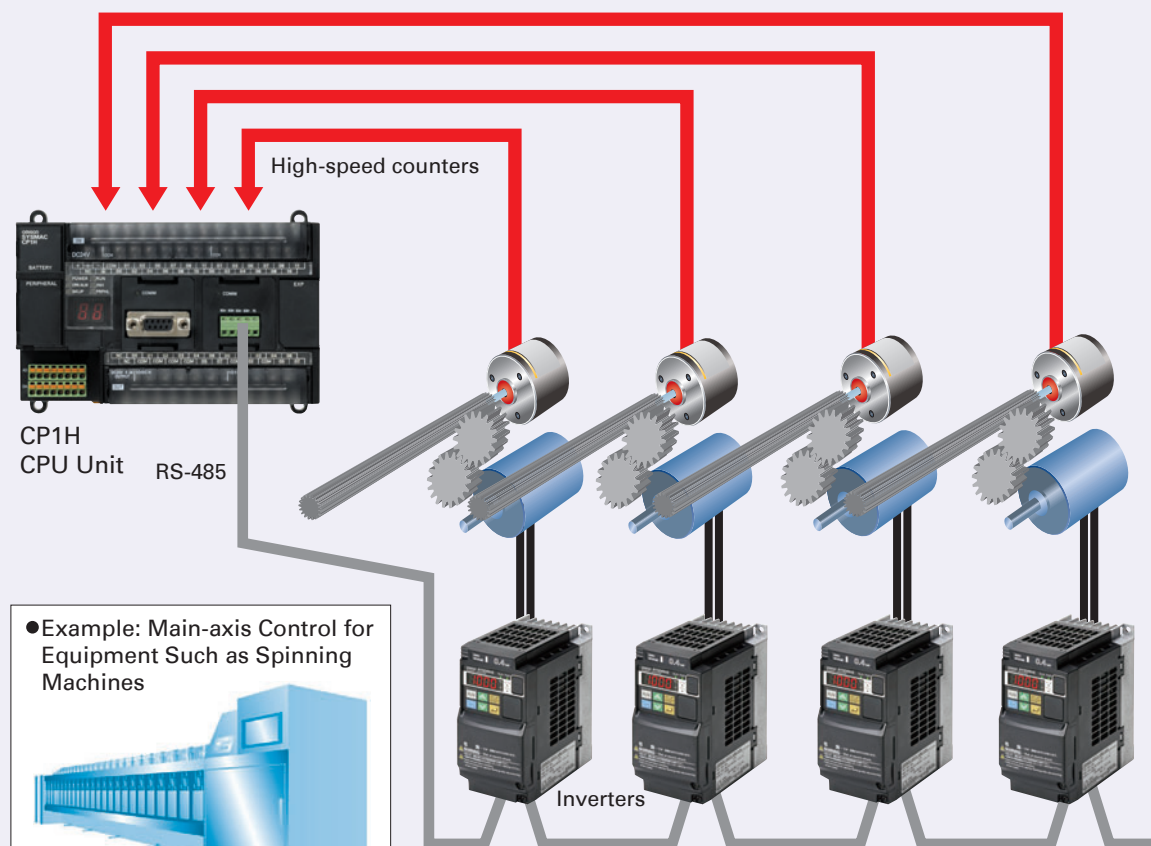

Applicable CPU Units and Functions

CP1H-Y CPU Unit

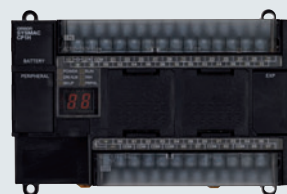

1 MHz (single-phase), 500 kHz (differential phases) for two axes, 100 kHz (single-phase), 50 kHz (differential phases) for two axes (four axes total)

CP1H-X□ CPU Unit

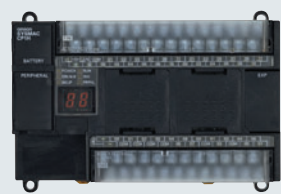

100 kHz (single-phase), 50 kHz (differential phases) for four axes

CP1L CPU Unit



100 kHz (single-phase) for four axes, or 50 kHz (differential phases) for two axes



Inverter Positioning

High-speed Positioning Operations Using Inverters Is Made Easy.

High-speed Counters

Inverter Positioning

Machinery Such As Ceramics Conveyor Equipment

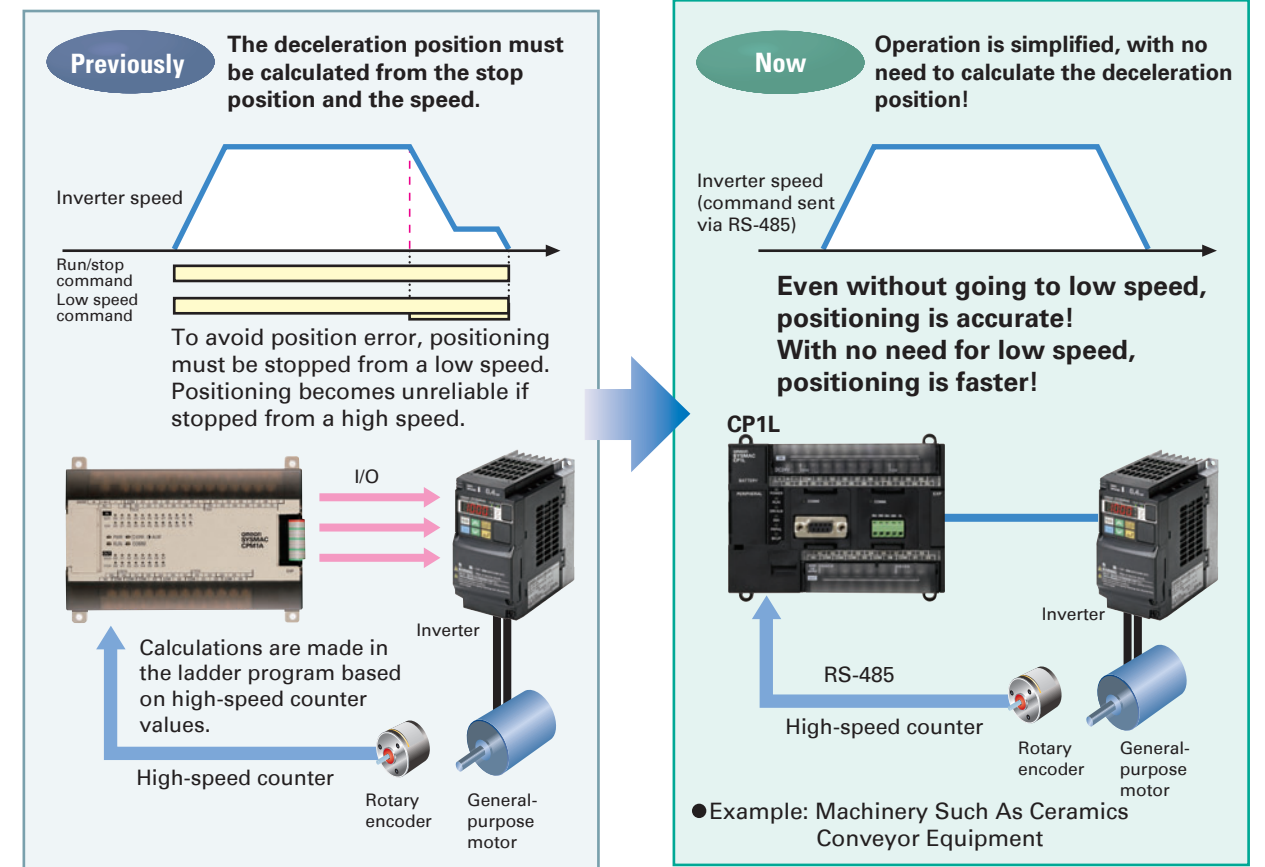

■ Overview of Inverter Positioning

The CP1L's built-in error counter function enables the following operation.

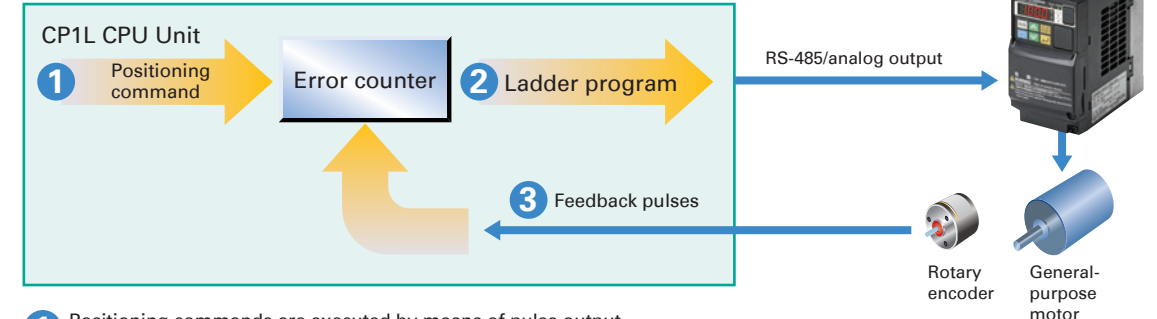

- 1 Positioning commands are executed by means of pulse output instructions. Pulse output instructions normally output pulses from the PLC, but pulses can be output to the error counter according to the operand setting in the instruction (such as PLS2).
- 2 The amount of pulses input to the error counter is converted to a speed command and output to the inverter. A command to the inverter is created in the ladder program using this speed command (proportional to the pulses remaining in the error counter). When RS-485 communications are executed, ladder programming for communicating with the inverter is created. When analog outputs are executed, ladder programming for analog outputs is created.
- 3 When a run/stop command is executed for the inverter, the motor is rotated and feedback pulses (for the amount of movement) are output from the encoder to the CP1L. The error counter value is decremented by these feedback pulses. The CP1L continues sending commands to the inverter until positioning is completed. This enables accurate positioning to the position output by the first position command.

Applicable CPU Units and Functions

CP1L CPU Unit



Inverter positioning function for two axes



A Standard USB Port and Two Serial Ports Enable Connections and Communications with a Wide Range of Components.

Up to two Option Boards can be mounted for RS-232C or RS-422A/485 communications. A peripheral USB port has been added to connect to a personal computer for a total of three communications ports, making it easy to simultaneously connect to a PT, various components (such as Inverters, Temperature Controllers, and Smart Sensors), Serial PLC Link for linking to other PLCs, and a personal computer.

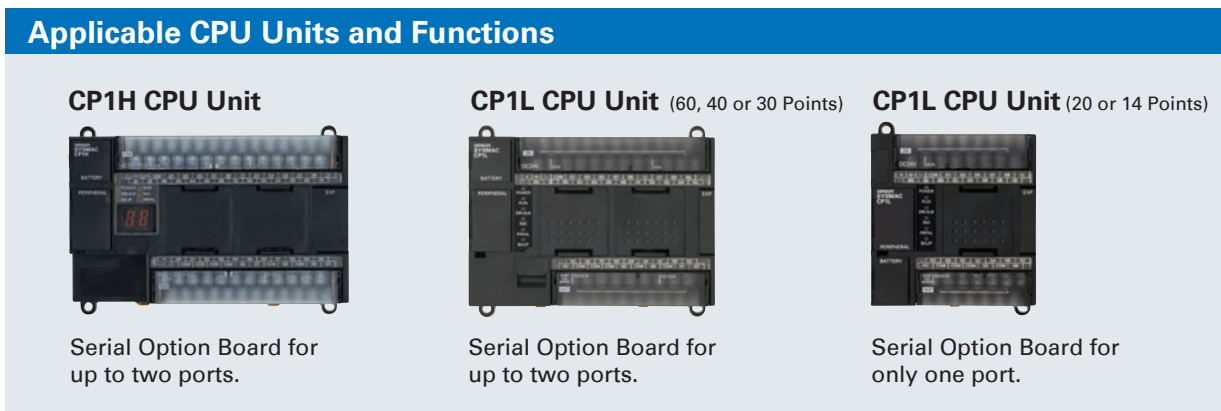
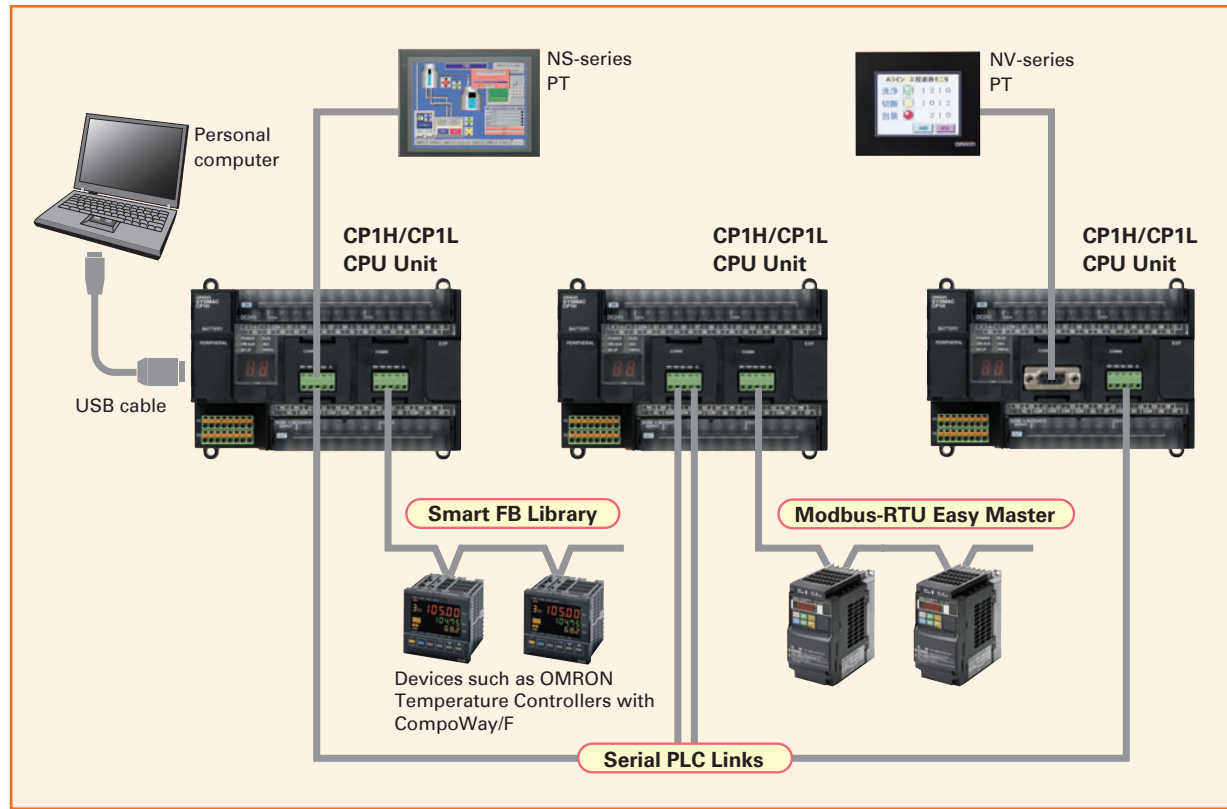

Serial PLC Links

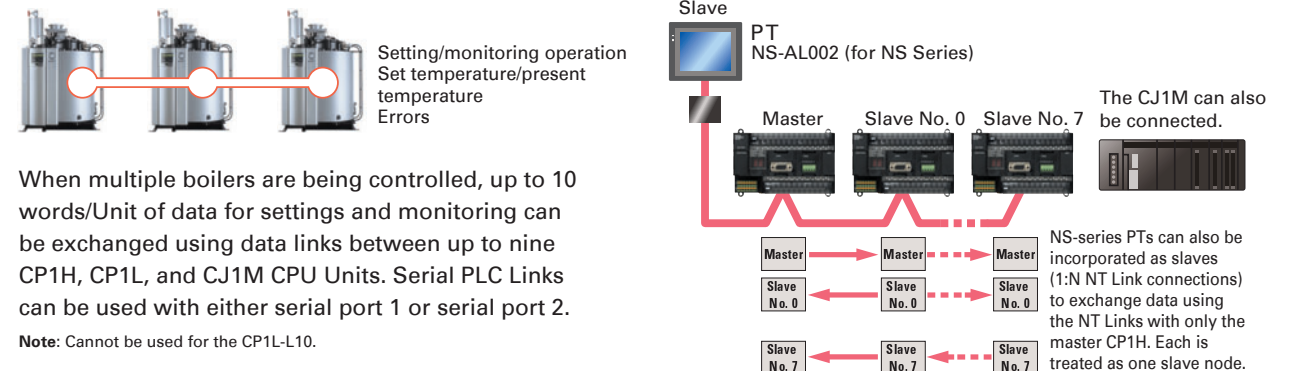

Modbus-RTU Easy Master

Connecting inverter speed control is made simple using the Modbus-RTU Easy Master. When the address, function, and data for a slave device are preset in a fixed memory area (DM Area), a message can be sent or received simply by turning ON an AR Area bit (A640.00 for port 1 or A641.00 for port 2) in the PLC.

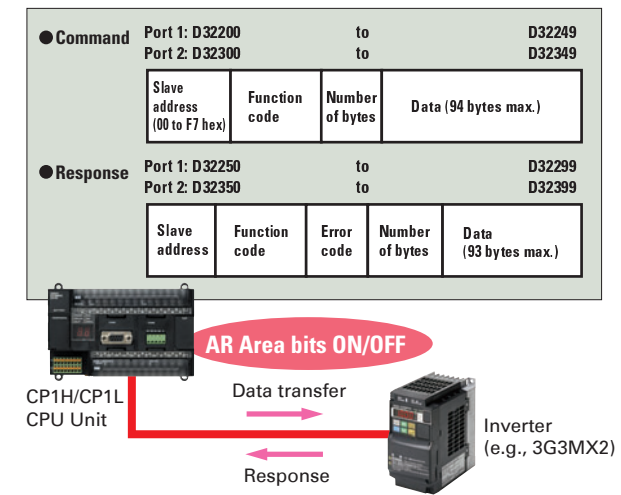

Easy Communications Programming Using OMRON Function Blocks

The OMRON Function Blocks provide function blocks for communicating with Temperature Controllers.

OMRON Function Blocks are provided for operations such as for setting SPs and reading PVs for Temperature Controllers by communications.

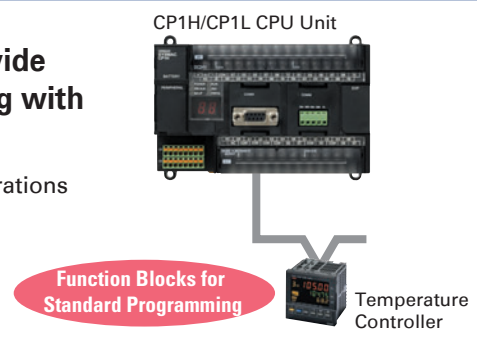



Ethernet Communications

Two ports can be used as an Ethernet port to perform Ethernet communications between the CP1H/CP1L and a host computer.

Connect to a general-purpose LAN simply by mounting a CP1W-CIF41 Ethernet Option Board to an option board slot on any of the CPU Units in the CP1H/CP1L except a CP1L-L10. Perform monitoring and programming with the CX-Programmer, or communicate between a host computer and the CP1H/CP1L using Ethernet by connecting with the FINS/TCP or FINS/UDP protocols, which are supported by all OMRON PLCs.

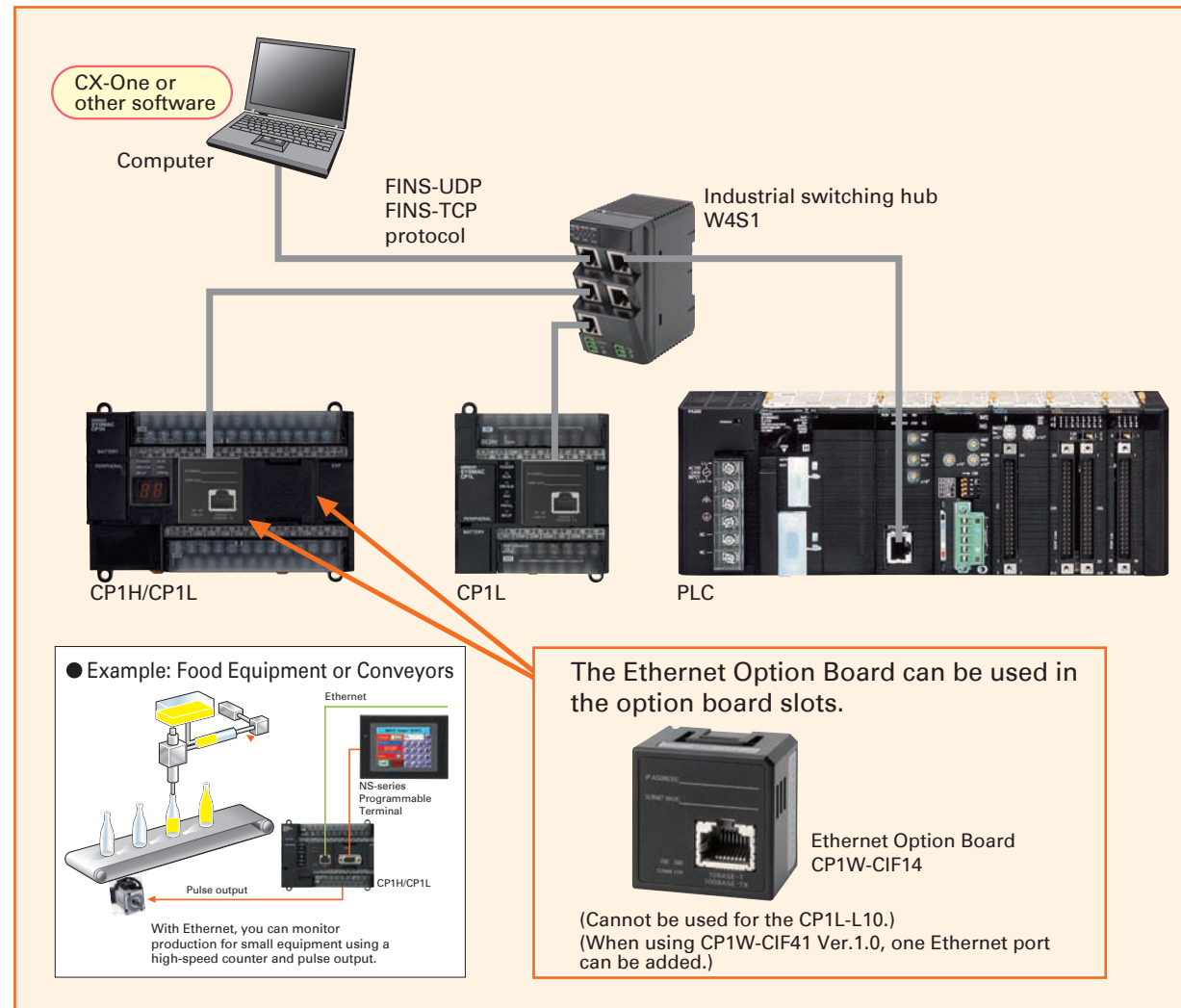

Applicable CPU Units and Functions

CP1H CPU Unit

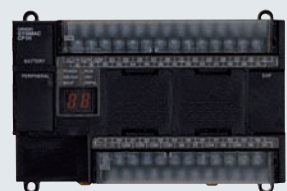

The Ethernet Option Board provides two ports.

CP1L CPU Unit (60, 40, or 30 Points)



The Ethernet Option Board provides two ports.

CP1L CPU Unit (20 or 14 Points)



The Ethernet Option Board provides only one port.



Analog I/O

Four Input Words and Two Output Words for XA CPU Units. Analog Control and Monitoring with Only a Single CPU Unit

Surface Inspections Using Inspection Devices

Mechanisms to Prevent Careless Mistakes in Cell Production (Such as Forgetting to Tighten Screws)

Oil Pressure Control in Forming Machines

Ethernet Communications

Analog I/O

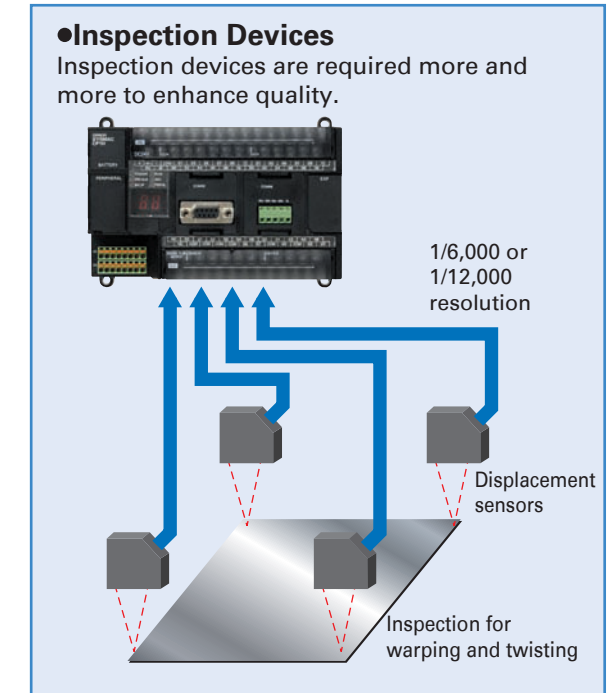
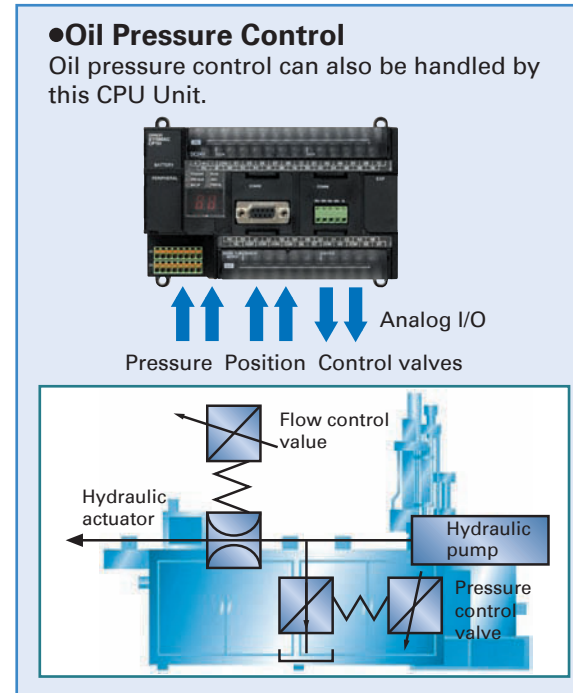
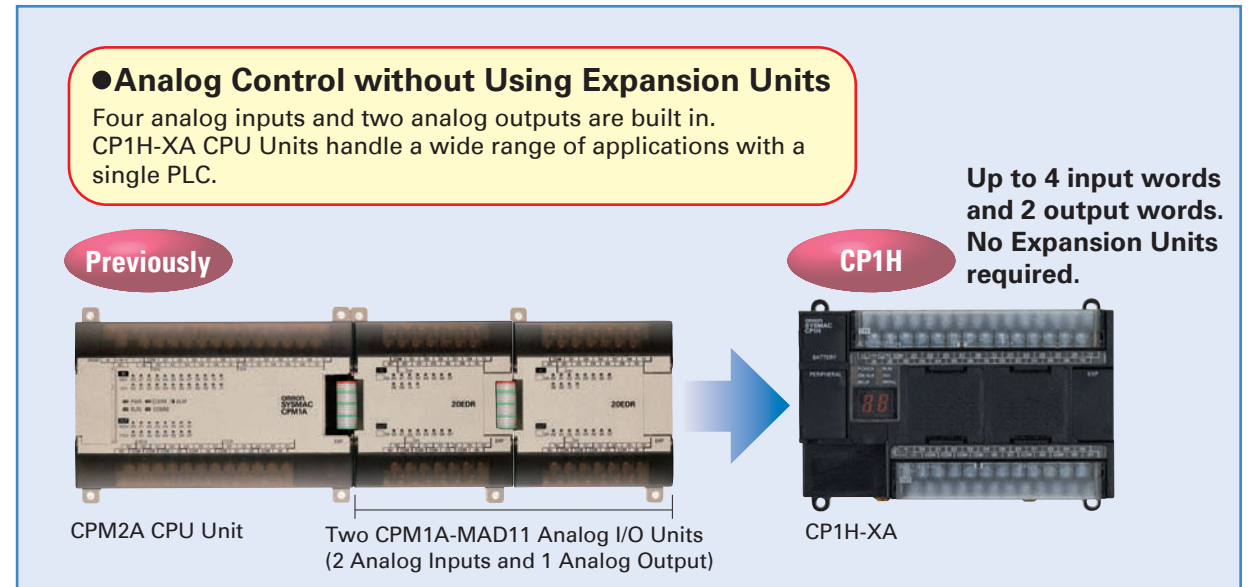

Applicable CPU Units and Functions

CP1H-XA CPU Unit

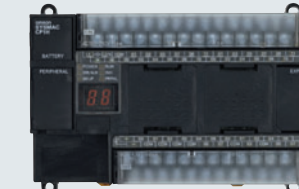

Four analog input words Two analog output words

●Complete with CP1W/CPM1A Analog Units.



- Unit with 4 Analog Inputs
- Units with 4 Analog Outputs
- Unit with 2 Analog Outputs
- Units with 2 Analog Inputs and 1 Analog Output



USB Peripheral Port

All CP-series CPU Units Provide a USB Port as a Standard Feature.

FA Integrated Tool Package

CX-One

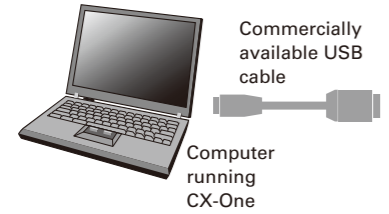

The built-in USB port lets you connect to a personal computer using a general-purpose cable.



Commercially available USB cable (A-type male connector to B-type female connector) can be used, helping to keep costs down.

(The CP1H/CP1L USB port is used only for connecting to a Programming Device.)

Note: Programming Consoles (CQM1H-PRO01, C200H-PRO027, etc.) cannot be used with CP1H and CP1L CPU Units.

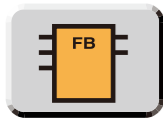

The Structured Text (ST) Language Makes Math Operations Even Easier.

In addition to ladder programming, function block logic can be written in ST language, which conforms to IEC 61131-3. Arithmetic processing is also possible with ST, including processing of absolute values, square roots, logarithms, and trigonometric functions (SIN, COS, and TAN). Processing that is difficult to write in ladder programming becomes easy using structured text.

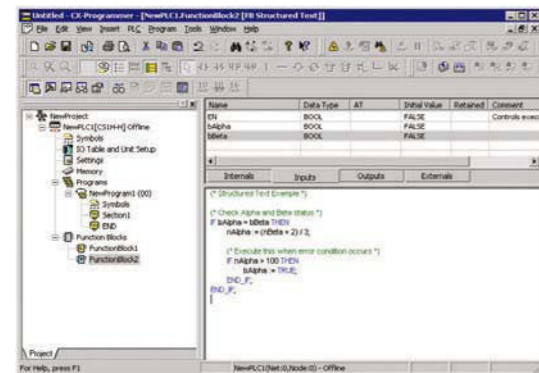

- **Structured Text Commands (Keywords)**
TRUE, FALSE.
IF, THEN, ELSE, ELSEIF, END_IF
DO, WHILE, END_WHILE.
REPEAT, UNTIL, END_REPEAT.
FOR, TO, BY, DO, END_FOR.
CASE, OF, END_CASE.
EXIT, RETURN.
- **Operators**
Addition (+), Subtraction (-), Multiplication (*), Division (/)
Parenthesis (brackets), Array Indexing (square brackets [])
Assignment Operator (=), Less Than Comparison Operator (<),
Less Than or Equal To Comparison Operator (<=),
Greater Than Comparison Operator (>),
Greater Than or Equal To Comparison Operator (>=),
Equals Comparison Operator (=),
Is Not Equal To Comparison Operator (<>),
Bitwise AND (AND or &), Bitwise OR (OR), Exclusive OR (XOR),
NOT (NOT), Exponentiation (**)
- **Numerical Functions**
ABS, SQRT, SQRT, LN, LOG, EXP, SIN, COS, TAN, ASIN, ACOS,
ATAN, EXPT
- **Arithmetic Functions**
Exponentiation (EXPT)

Note: The CP1H/CP1L CPU Units support the same function blocks and ST language as CS/CJ-series CPU Units with unit version 3.0.



High-speed Processing

Up to Eight Interrupt Inputs Can Be Used.

Eight interrupt inputs are built in. Quick-response inputs for pulse widths of 50 μs. The interrupt inputs can also be used as counters. (Response frequency: 5 kHz total for 8 interrupt inputs)

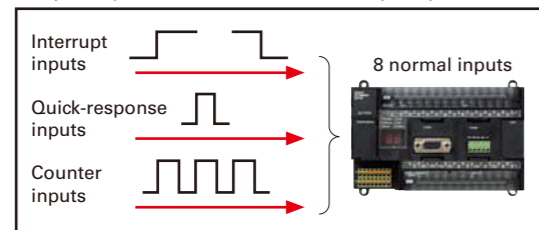

The normal inputs can be set in the PLC Setup as interrupt, quick-response, or counter inputs. (There are 8 normal inputs for the CP1H-X/XA, 6 for the CP1H-Y, 6 for the CP1L with 20, 30, or 40 points, and 4 for the CP1L with 14 points.)

Compared with the CPM2A, Basic Instructions Are at Least Six Times Faster and MOV Instructions Are 26 Times Faster.

Processing speed has been increased not only for basic instructions but also for special instructions as well. Faster processing of approximately 500 instructions speeds up the entire system.

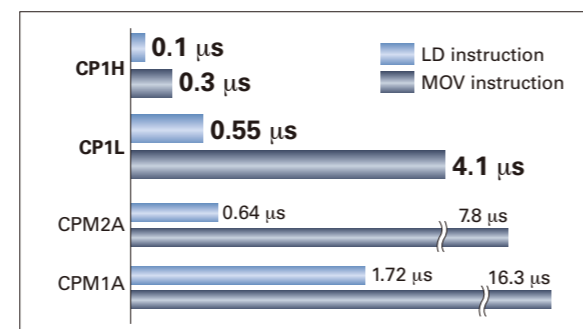

LCD Displays and Settings

Compact Display and Setting Device

Available to Mount on CPU Unit for Easy Maintenance and Startup Adjustments

USB Peripheral Port

LCD Displays and Settings

Data values in the PLC can be easily monitored or changed by adding the new LCD Option Board. This enables visually checking the operation status, such as error occurrence and error details. Register in advance functions that you use often to quickly perform settings and confirm operation. Functionality can also be expanded to items not included in the CPU Unit, such as calendars and timers.



CP1H/CP1L (except CP1L-L10)

An LCD Option Board interface can be used in option board slot 1.



CP1W-DAM01 LCD Option Board

Monitoring and Changing Data Values

I/O Monitoring

All memory area values can be monitored and changed. Switch between decimal and hexadecimal or monitor 2-word hexadecimal data, such as high-speed counter values, in decimal.



Simply press the up and down keys to quickly display up to 16 registered monitor screens.

User Monitor Settings and Messages

Up to seven fixed characters and the present value of word data can be displayed. Simply press the up and down keys from the initial screen to perform monitoring. Of course, you can also change the settings. Plus, up to 48 characters can be set in advance and then displayed when a specified bit turns ON. This makes onsite setting and confirming faster.



Visual Checking of Status with Display of PLC Error Details

I/O Monitoring

The backlight on the LCD screen will turn red when an error occurs to notify you of the error status. You can monitor the displayed error details and the error log.



Expanded Functionality with Calendar Timers, and Other Items Not Included in the CPU Units

Variety of Additional Functions

You can use calendar timers, weekly timers, and daily timers. Sixteen of each timer type can be set.

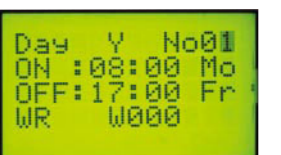

Applicable CPU Units and Functions

CP1H



Can be mounted to option board slot 1.

CP1L

CPU Units with 30, 40, or 60 I/O points



Can be mounted to option board slot 1.

CP1L

CPU Units with 14 points or 20 I/O points



Can be mounted to option board slot 1.

Shortened System Design and Startup. Increased Program Reusability.

Integrated OMRON PLCs and Component Support Software

FA Integrated Tool Package



The CX-One is an FA Integrated Tool Package for connecting, setting, and programming OMRON components, including PLCs. CP1H/CP1L programming and settings can be done with just the CX-Programmer, but the CX-One provides Support Software for setting and programming PTs, Temperature Controllers, and many other components. Using the CX-One makes programming and setup easy, shortening the total lead time required for starting up machines and equipment.

CX-One Configuration

- 1 **Network Software**
 - CX-Integrator CX-FLnet CX-Protocol
 - CX-ConfiguratorFDT Network Configurator
- 2 **PLC Software**
 - CX-Programmer
 - CX-Simulator
 - SwitchBox Utility
- 3 **HMI Software**
 - CX-Designer
 - Ladder Monitor software included. (See note 1.)
 - NV-Designer (See note 2.)
- 4 **Motion Controller Software**
 - CX-Drive
 - CX-Motion-NCF CX-Motion-MCH
 - CX-Position
 - CX-Motion
- 5 **PLC Software**
 - CX-Process Tool
 - NS-series Face Plate Auto-Builder
- 6 **Component Software**
 - CX-Thermo

Note: 1. The Ladder Monitor is required to monitor ladder programs running on CS/CJ-series PLCs from an NS-series PT.
2. Include with CX-One Lite version 4.0 and in CX-One version 3.2 or later.

Easy-to-use Programming Software. Programming with Function Blocks (Ladder Diagrams/ST Language) Is Also Standard.

CX-Programmer

CP1L except for CPU Units with 60 points: Version 7.2 (CX-One version 2.1) or later
CP1L CPU Units with 10 or 60 points: Version 7.3 (CX-One version 2.13) or later
CP1H: Version 6.2 (CX-One version 1.1) or later

Easy Operation Simplifies Programming and Debugging.

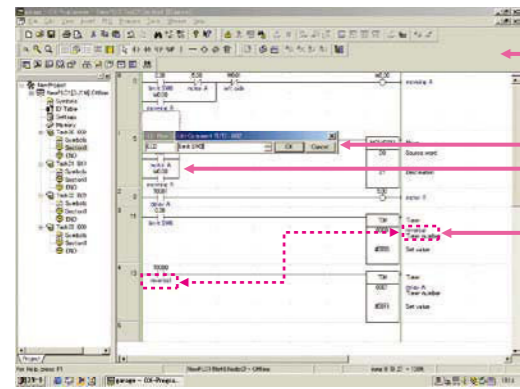

- Shortcut keys can be easily checked using the ladder key guide. Programming is simplified by key inputs, such as the **C** Key for an NC input (contact), the **O** Key for an OUT instruction, and the **I** Key for special instructions.
 - C** Key, address, **;** Key, comment, **;** Key. The CX-Programmer automatically goes into character input mode when it is time to enter a comment. Special instructions can be input as follows:
-
- Simple key inputs are also available to connect lines. **Ctrl** + **←** **↑** **→** **↓**
 - Comments can be added for timer and counter instructions through timer and counter input bits.

The Password Function Enables Protecting Important Programs.

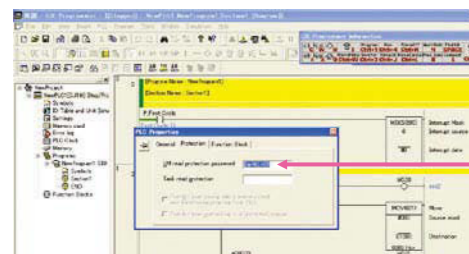

Eight-character Password Protection
Important programs can be protected by setting a password from the CX-Programmer (with the PLC online).

Password setting: Up to 8 alphanumeric characters (A-Z, a-z, 0-9)

Improved Functional Connectivity with HMI Design Software and Integration of Component Software

Configured with an NS-series PT

CX-Designer

The CX-Designer can be started from the CX-Integrator's NT Link Window. It can be used to design HMI screens. In addition, the Smart Active Parts (SAP) Library is provided with the CX-Designer to enable easily creating setting screens for devices such as Temperature Controllers.

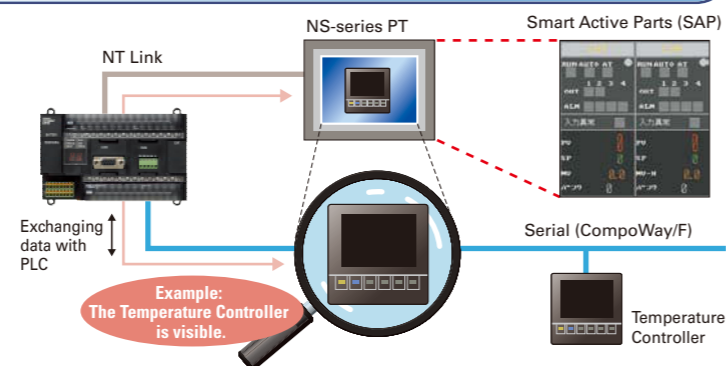

MEMO.

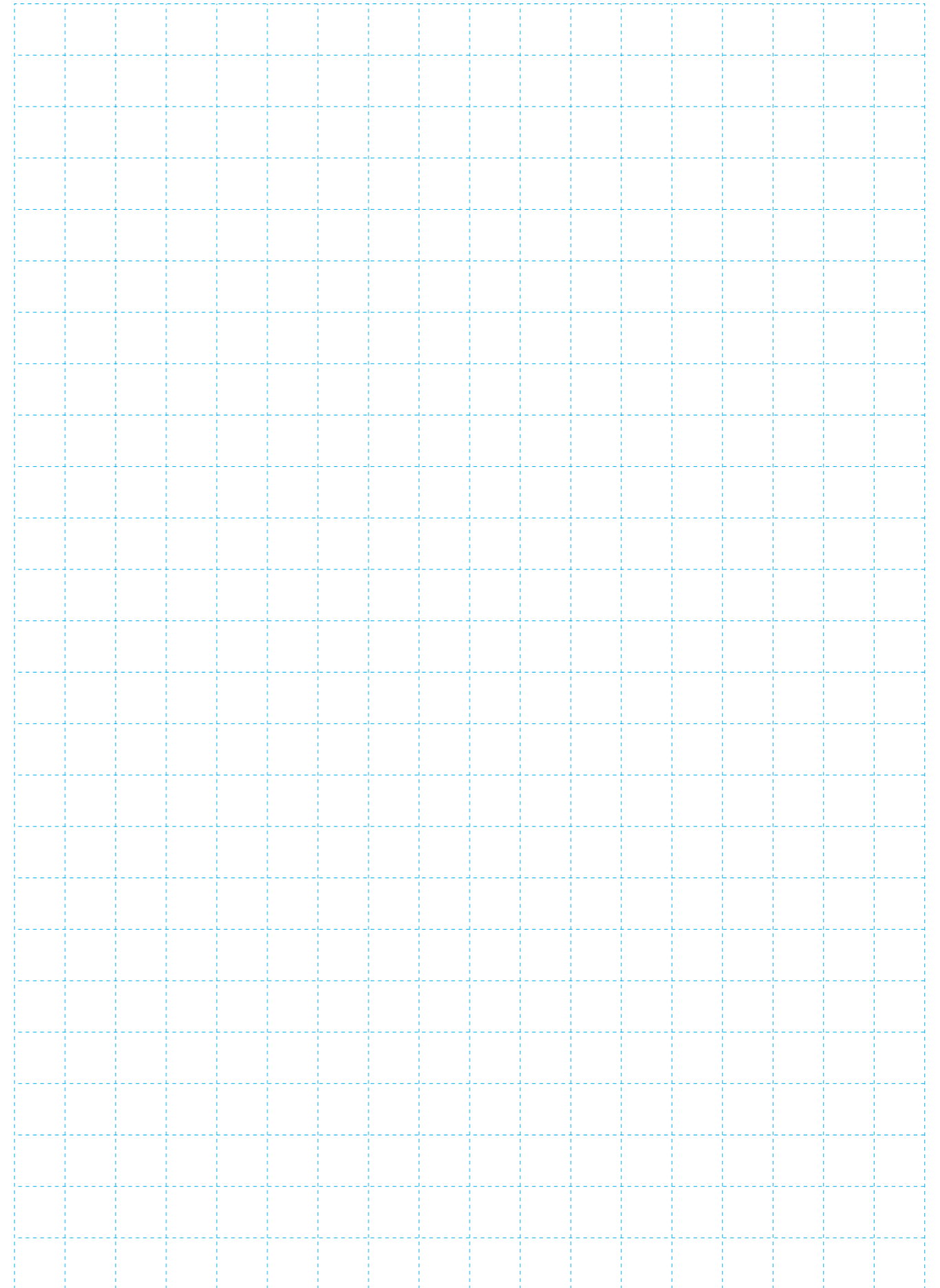

Memory Cassette

- Data, such as programs and initial memory values, can be stored on a Memory Cassette (optional) and copied to other systems.
- The Memory Cassette can also be used when installing new versions of application programs.

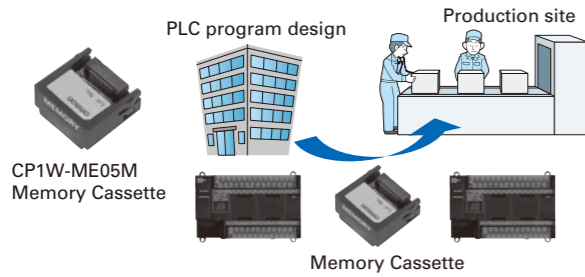

Status Displayed on 7-segment Display (CP1H only)

- The 7-segment display provides two display digits.
- In addition to displaying error codes for errors detected by the PLC, codes can be displayed on the display from the ladder program.
- The 7-segment display is useful for maintenance as well, allowing problems that arise during system operation to be grasped without using any Support Software.

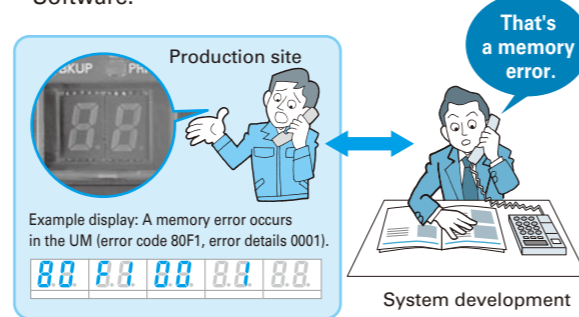

Clock Function

- All CP1H/CP1L CPU Units have a built-in clock.
- Shopping Mall Fountain Control
- Controlling a Fountain for a Period of Time

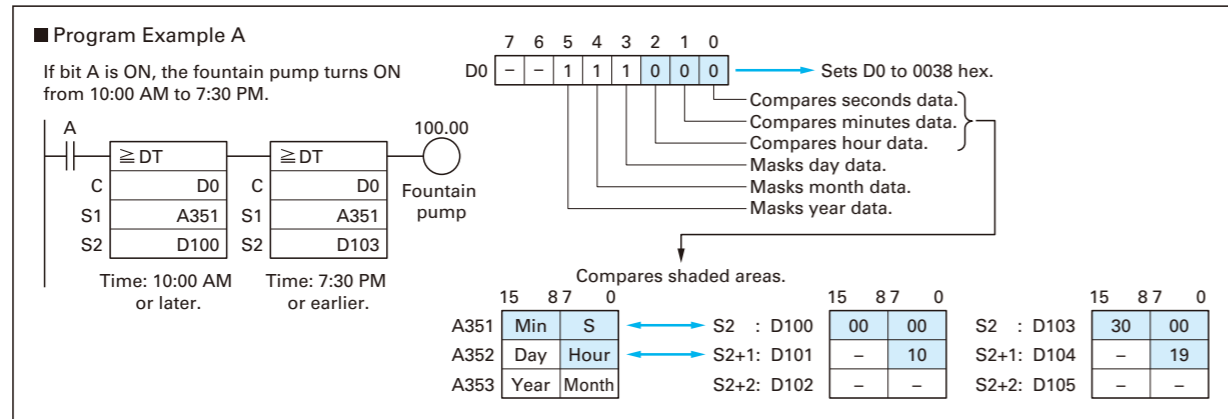

Analog Inputs Are Made Simple.

An analog adjustment and an external analog setting input connector are provided.

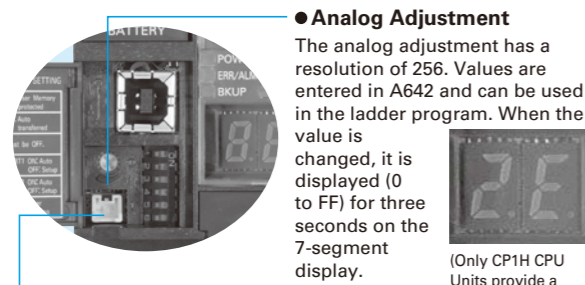

External Analog Setting Input Connector

This connector is used for an 0 to 10-V analog input with a 256 resolution. Each CP1H/CP1L CPU Unit has one of these connectors built in. A device, such as a potentiometer, can be connected to enable direct manual operation and control from a control panel. The maximum cable length is 3 meters. A connecting cable (1 m) is included with the CPU Unit.

Battery-free Operation

- The values in the DM Area (32K words) are saved in the CPU Unit's built-in flash memory as initial values, and can be read at startup.
- Battery-free operation can be used to enable saving production data and machine parameters in the DM Area, turning OFF the power, and then using then same data again for the next production run. (This is ideal for machinery that is only used seasonally.)

Note:

- A battery is required for the clock function and to retain the status of HR Area bits and counter values.
- A battery is provided as a standard feature with the CPU Unit.
- The user program (ladder program) is stored in built-in flash memory, so no battery is required to back it up.

CP1H CPU Unit Nomenclature

● Front

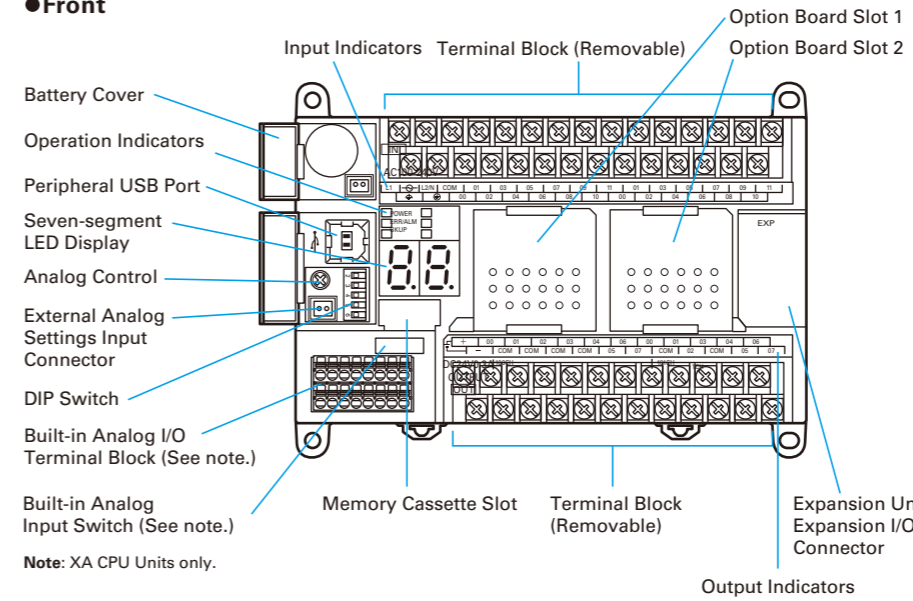

● Back

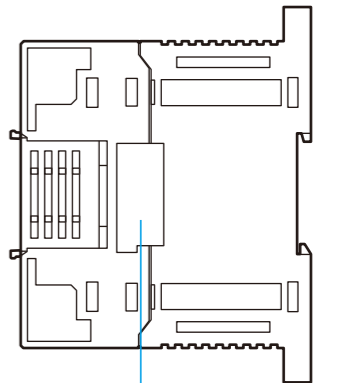

CP1L CPU Unit Nomenclature

● CP1L CPU Units (M Type) with 40 Points

● Front

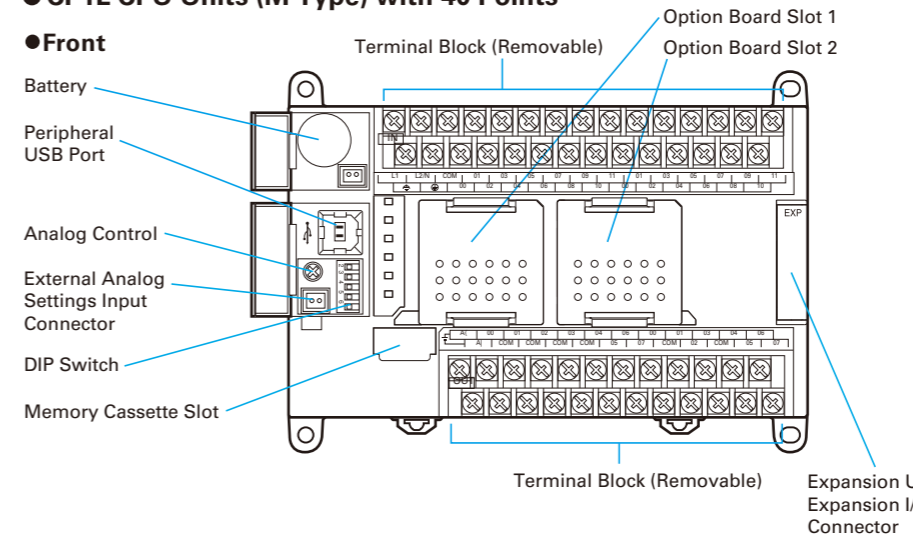

● Back

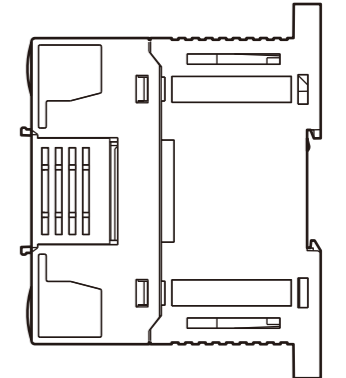

● CP1L CPU Units (L Type) with 20 or 14 Points

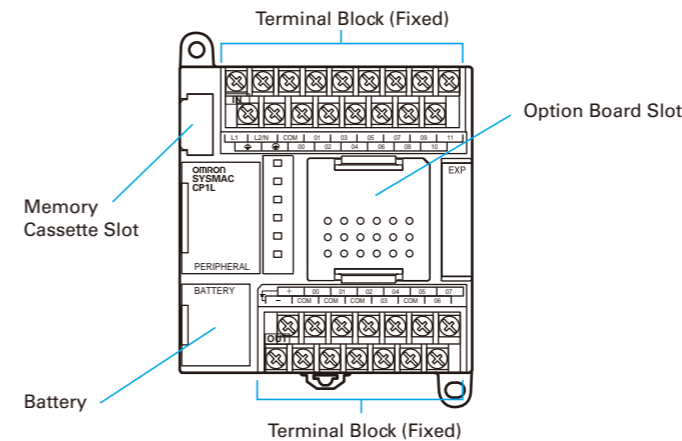

● CP1L CPU Units (L Type) with 10 Points

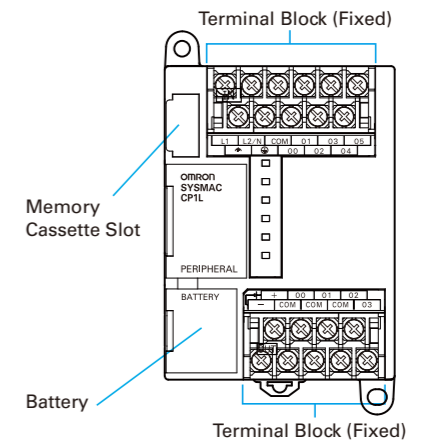

Maximum Number of CP1W/CPM1A Expansion Unit and Expansion I/O Units

● CP1H CPU Unit

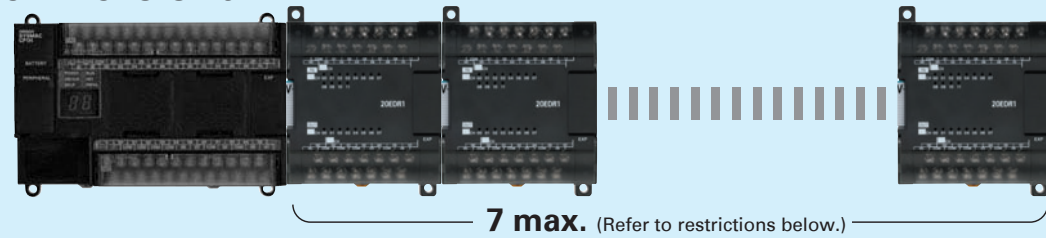

● CP1L (M) CPU Units with 60, 40, or 30 Points

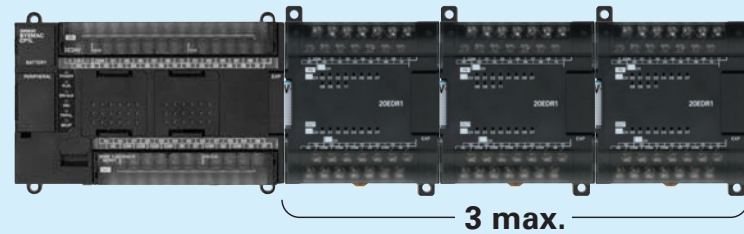

● CP1L (L) CPU Units with 20 or 14 Points

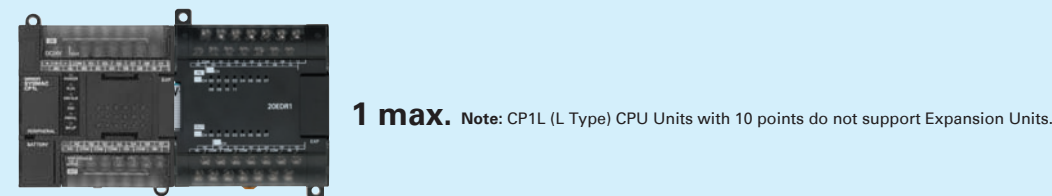

Restrictions on the Number of CP1H Expansion Unit and I/O Unit Connections

Up to seven Expansion Units and Expansion I/O Units can be connected when a CP1H CPU Unit is used, but the following restrictions apply. Observe these restrictions when using the models in the shaded areas in the following tables. A maximum total of 15 input words is allocated for Expansion Units and a maximum total of 15 output words is allocated for Expansion Units and Expansion I/O Units.

■ Words Allocated to CP1W Expansion Units and Expansion I/O Units

Unit type	Model	No. of words		
		Input	Output	
Expansion I/O Units	40 I/O points	CP1W-40EDR	2	2
		CP1W-40EDT	2	2
		CP1W-40EDT1	2	2
	32 outputs	CP1W-32ER	—	4
		CP1W-32ET	—	4
		CP1W-32ET1	—	4
	20 I/O points	CP1W-20EDR1	1	1
		CP1W-20EDT	1	1
		CP1W-20EDT1	1	1
	16 outputs	CP1W-16ER	—	2
CP1W-16ET		—	2	
CP1W-16ET1		—	2	
8 inputs	CP1W-8ED	1	—	
	CP1W-8ER	—	1	
	CP1W-8ET	—	1	
8 outputs	CP1W-8ET1	—	1	
	CP1W-8ED	1	—	
	CP1W-8ER	—	1	
Analog Units	2 analog inputs, 1 analog output	CP1W-MAD11	2	1
	4 analog inputs	CP1W-AD041	4	2
	4 analog outputs	CP1W-DA041	—	4
Temperature Sensor Units	2 analog outputs	CP1W-DA021	—	2
	2 thermocouple inputs	CP1W-TS001	2	—
	4 thermocouple inputs	CP1W-TS002	4	—
	2 platinum resistance thermometer inputs	CP1W-TS101	2	—
	4 platinum resistance thermometer inputs	CP1W-TS102	4	—
CompoBus/S I/O Link Unit	8 inputs and 8 outputs	CP1W-SRT21	1	1

For example, the CP1W-TS002 Temperature Sensor Unit is allocated four words per Unit, so no more than three Units can be connected (4 words x 3 Units = 12 words). It would then be possible to mount a combination of other Units to use the remaining three input and 15 output words.

Examples of Possible Combinations

Number of Units	Input	Output
CP1H-X40DR-A	—	—
CP1W-TS002 x 3	4 words x 3 Units = 12 words	0 words
CP1W-TS001 x 1	2 words x 1 Unit = 2 words	0 words
CP1W-20EDR1 x 1	1 word x 1 Unit = 1 word	1 word x 1 Unit = 1 word
CP1W-DA041 x 2	0 words	4 words x 2 Units = 8 words
Total: 7 Units	Total: 15 words	Total: 9 words
≤ 7 Units	≤ 15 words	≤ 15 words

Using CP1W-CN811 I/O Connecting Cable

- I/O Connecting Cable can be connected to any Unit from the CP1H/CP1L CPU Unit to the third Expansion Unit or Expansion I/O Unit (i.e., the fourth Unit).
- Only one I/O Connecting Cable can be used in each CP1H or CP1L PLC.
- Even when I/O Connecting Cable is used, the above restrictions on the number of connectable CP1W/CPM1A Expansion Units and Expansion I/O Units still apply.

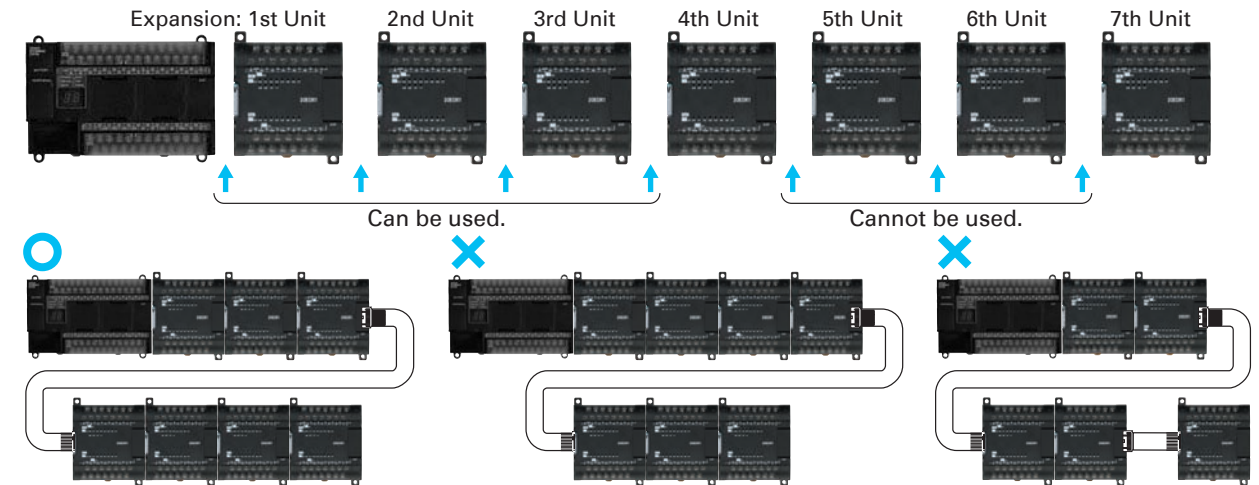

Using CJ-series Special I/O Units or CPU Bus Units with a CP1H CPU Unit

Up to two CJ-series Special I/O Units or CPU Bus Units can be connected by using a CP1W-EXT01 CJ Unit Adapter. The number of Units that can be used is as described below.

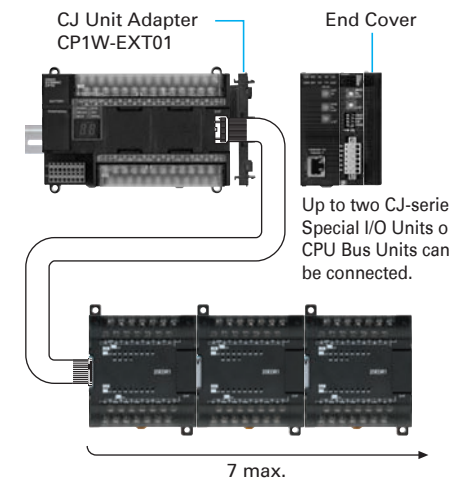

■ CJ-series Special I/O Units and CPU Bus Units (For details, refer to the CJ1 Catalog (Cat. No. P052)).

Unit name	Model	5 V Current consumption (A)		
Analog Input Units	CJ1W-AD042	0.52 A		
	CJ1W-AD081-V1	0.42 A		
	CJ1W-AD041-V1	0.32 A		
Analog Output Units	CJ1W-DA042V	0.40 A		
	CJ1W-DA08V	0.14 A		
	CJ1W-DA08C	0.14 A		
	CJ1W-DA041	0.12 A		
	CJ1W-DA021	0.12 A		
Analog I/O Unit	CJ1W-MAD42	0.58 A		
	CJ1W-PH41U	0.30 A		
Process Input Units	CJ1W-AD04U	0.32 A		
	CJ1W-PTS51	0.25 A		
	CJ1W-PTS52	0.25 A		
	CJ1W-PTS15	0.18 A		
	CJ1W-PTS16	0.18 A		
	CJ1W-PDC15	0.18 A		
	CJ1W-PDC16	0.18 A		
Temperature Control Units	CJ1W-TC001	0.25 A		
	CJ1W-TC002			
	CJ1W-TC003			
	CJ1W-TC004			
	CJ1W-TC101			
	CJ1W-TC102			
	CJ1W-TC103			
	CJ1W-TC104			
	CompoBus/S Master Unit		CJ1W-SRM21	0.15 A
	CompoNet Master Unit		CJ1W-CRM21	0.40 A
Position Control Units	CJ1W-NC113	0.25 A		
	CJ1W-NC213			
	CJ1W-NC413	0.36 A		
	CJ1W-NC133	0.25 A		
	CJ1W-NC233	0.25 A		
	CJ1W-NC433	0.36 A		
High-speed Counter Unit	CJ1W-CT021	0.25 A		
ID Sensor Units	CJ1W-V680C11	0.26 A (24 VDC 0.13 A)		
	CJ1W-V680C12	0.32 A (24 VDC 0.26 A)		
	CJ1W-V600C11	0.26 A (24 VDC 0.12 A)		
	CJ1W-V600C12	0.32 A (24 VDC 0.24 A)		
Serial Communications Units	CJ1W-SCU42	0.36 A*		
	CJ1W-SCU22	0.28 A*		
	CJ1W-SCU32	0.40 A		
	CJ1W-SCU41-V1	0.38 A*		
	CJ1W-SCU21-V1	0.28 A*		
	CJ1W-SCU31-V1	0.38 A		
Ethernet Unit	CJ1W-ETN21	0.37 A		
EtherNet/IP Unit	CJ1W-EIP21	0.41 A		
DeviceNet Unit	CJ1W-DRM21	0.33 A		
Controller Link Unit	CJ1W-CLK23	0.35 A		
MECHATROLINK-II Position Control Unit	CJ1W-NC271	0.36 A		
	CJ1W-NC471			
	CJ1W-NC71			
MECHATROLINK-II Motion Control Unit	CJ1W-MCH71	0.6 A		
FL-net Unit	CJ1W-FLN22	0.37 A		
Storage/Processing Unit	CJ1W-SPU01-V2	0.56 A		

●Based on the current consumption when CJ-series Special I/O Units or CPU Bus Units are used with a CP1H CPU Unit, the maximum number of Units that can be used is two CJ-series Units and seven CP1W/CPM1A Expansion Units and Expansion I/O Units. The current consumption for the CP1H must be no more than 2 A for 5 V and 1 A for 24 V, and the total current consumption must be no more than 30 W. Check the total current consumption to be sure these limits are not exceeded referring to page 29 for the CP1H CPU Unit and CP1W Expansion Unit and Expansion I/O Unit current consumptions and to the above table for CJ-series Unit current consumptions.

* The current consumption increases by 0.15 A/Adapter when NT-AL001 Link Adapters are used.

CPU Unit Specifications

■ I/O Bits and I/O Allocations

With CP1H and CP1L CPU Units, the beginning input and output words (CIO 0 and CIO 100) are allocated by the CPU Unit one or two words at a time. I/O bits are allocated in word units in order of connection to Expansion Units and Expansion I/O Units connected to a CPU Unit.

CPU Unit	Allocated words	
	Inputs	Outputs
CP1H CPU Unit with 40 I/O points	CIO 0 and CIO 1	CIO 100 and CIO 101
CP1L CPU Unit with 10, 14, or 20 I/O points	CIO 0	CIO 100
CP1L CPU Unit with 30 or 40 I/O points	CIO 0 and CIO 1	CIO 100 and CIO 101
CP1L CPU Unit with 60 I/O points	CIO 0, CIO 1, and CIO 2	CIO 100, CIO 101, and CIO 102

Note: For details on the number of words allocated to Expansion Units and Expansion I/O Units, refer to *Words Allocated to CP1W Expansion Units and Expansion I/O Units* on page 26.

● Example: I/O Bit Allocations When Expansion Units Are Connected

CPU Unit with 40 I/O Points + Temperature Sensor Unit + Analog Output Unit + Expansion I/O Unit with 40 I/O Points

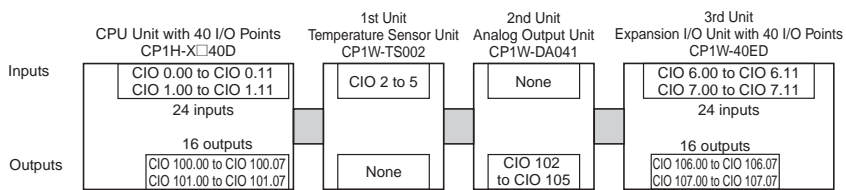

■ General Specifications

Item	Type	AC power supply models	DC power supply models
	Model	CP1H-□□□-A CP1L-□□□-A	CP1H-□□□-D CP1L-□□□-D
Power supply		100 to 240 VAC 50/60 Hz	24 VDC
Operating voltage range		85 264 VAC	20.4 to 26.4 VDC
Power consumption		100 VA max. (CP1H-□□□-A) 50 VA max. (CP1L-M60/-M40/-M30□□-A) (See next page.) 30 VA max. (CP1L-L20/-L14/-L10□□-A)	50 W max. (CP1H-□□□-D) 20 W max. (CP1L-M60/-M40/-M30□□-D) (See next page.) 13 W max. (CP1L-L20/-L14/-L10□□-D)
Inrush current (See note.)		100 to 120 VAC inputs: 20 A max. (for cold start at room temperature) 8 ms max. 200 to 240 VAC inputs: 40 A max. (for cold start at room temperature), 8 ms max.	30 A max. (for cold start at room temperature) 20 ms max.
External power supply		300 mA at 24 VDC (CP1H, CP1L-M60/-M40/-M30□□-A) 200 mA at 24 VDC (CP1L-L20/-L14/-L10□□-A)	None
Insulation resistance		20 MΩ min. (at 500 VDC) between the external AC terminals and GR terminals	No insulation between primary and secondary for DC power supply
Dielectric strength		2,300 VAC at 50/60 Hz for 1 min between the external AC and GR terminals, leakage current: 5 mA max.	No insulation between primary and secondary for DC power supply
Noise immunity		Conforms to IEC 61000-4-4. 2 kV (power supply line)	
Vibration resistance		Conforms to JIS C0040. 10 to 57 Hz, 0.075-mm amplitude, 57 to 150 Hz, acceleration: 9.8 m/s ² in X, Y, and Z directions for 80 minutes each. Sweep time: 8 minutes × 10 sweeps = total time of 80 minutes)	
Shock resistance		Conforms to JIS C0041. 147 m/s ² three times each in X, Y, and Z directions	
Ambient operating temperature		0 to 55°C	
Ambient humidity		10% to 90% (with no condensation)	
Ambient operating environment		No corrosive gas	
Ambient storage temperature		-20 to 75°C (Excluding battery.)	
Power holding time		10 ms min.	2 ms min.

Note: The above values are for a cold start at room temperature for an AC power supply, and for a cold start for a DC power supply.

- A thermistor (with low-temperature current suppression characteristics) is used in the inrush current control circuitry for the AC power supply. The thermistor will not be sufficiently cooled if the ambient temperature is high or if a hot start is performed when the power supply has been OFF for only a short time. In those cases the inrush current values may be higher (as much as two times higher) than those shown above. Always allow for this when selecting fuses and breakers for external circuits.
- A capacitor charge-type delay circuit is used in the inrush current control circuitry for the DC power supply. The capacitor will not be charged if a hot start is performed when the power supply has been OFF for only a short time, so in those cases the inrush current values may be higher (as much as two times higher) than those shown above.

CPU Unit Specifications

■ Current Consumption

The power consumption shown on page 28 is the maximum power consumption. To obtain the correct power consumption for the system configuration, calculate the power consumption for the external power supply from the current consumption given below for the CPU Unit, Expansion Units, and Expansion I/O Units. (When using CJ-series Units with the CP1H, add the current consumption for the CJ-series Units shown on page 27.)

● CPU Units

Model	Current consumption		External power supply
	5 VDC	24 VDC	24 VDC (See note 5.)
CP1H-X40DR-A	0.42 A	0.07 A	0.3 A max. (0.9 A max.)
CP1H-X40DT-D	0.50 A	0.01 A	---
CP1H-X40DT1-D	0.50 A	0.02 A	---
CP1H-XA40DR-A	0.43 A	0.18 A	0.3 A max. (0.8 A max.)
CP1H-XA40DT-D	0.51 A	0.12 A	---
CP1H-XA40DT1-D	0.51 A	0.15 A	---
CP1H-Y20DT-D	0.55 A	---	---
CP1L-M60DR-A	0.25 A	0.14 A	0.3 A max. (0.5 A max.)
CP1L-M60DT-A	0.39 A	0.03 A	0.3 A max. (0.6 A max.)
CP1L-M60DR-D	0.25 A	0.14 A	---
CP1L-M60DT-D	0.39 A	0.03 A	---
CP1L-M60DT1-D	0.39 A	0.03 A	---
CP1L-M40DR-A	0.22 A	0.08 A	0.3 A max. (0.6 A max.)
CP1L-M40DT-A	0.31 A	0.03 A	0.3 A max. (0.6 A max.)
CP1L-M40DR-D	0.22 A	0.08 A	---
CP1L-M40DT-D	0.31 A	0.03 A	---
CP1L-M40DT1-D	0.31 A	0.03 A	---
CP1L-M30DR-A	0.21 A	0.07 A	0.3 A max. (0.6 A max.)
CP1L-M30DT-A	0.28 A	0.03 A	0.3 A max. (0.6 A max.)
CP1L-M30DR-D	0.21 A	0.07 A	---
CP1L-M30DT-D	0.28A	0.03 A	---
CP1L-M30DT1-D	0.28 A	0.03 A	---
CP1L-L20DR-A	0.20 A	0.05 A	0.2 A max.
CP1L-L20DT-A	0.24 A	0.03 A	0.2 A max.
CP1L-L20DR-D	0.20A	0.05 A	---
CP1L-L20DT-D	0.24 A	0.03 A	---
CP1L-L20DT1-D	0.24 A	0.03 A	---
CP1L-L14DR-A	0.18 A	0.04 A	0.2 A max.
CP1L-L14DT-A	0.21 A	0.03 A	0.2 A max.
CP1L-L14DR-D	0.18 A	0.04 A	---
CP1L-L14DT-D	0.21 A	0.03 A	---
CP1L-L14DT1-D	0.21 A	0.03A	---
CP1L-L10DR-A	0.16 A	0.03 A	0.2 A max.
CP1L-L10DT-A	0.18 A	0.03 A	0.2 A max.
CP1L-L10DR-D	0.16 A	0.03A	---
CP1L-L10DT-D	0.18 A	0.03 A	---
CP1L-L10DT1-D	0.18 A	0.03 A	---

Note: 1. The current consumption of the CP1W-ME05M Memory Cassette and the CP1W-CIF01/CIF11 Option Boards are included in the current consumption of the CPU Unit.

2. CPU Units with DC power do not provide an external power supply.

3. The current consumptions given in the following table must be added to the current consumption of the CPU Unit if an Expansion Unit or Expansion I/O Unit is connected.

4. The external power supply cannot be used if an Expansion Unit or Expansion I/O Unit is connected to a CPU Unit with 14 or 20 I/O points.

5. Values in parentheses are the maximum external power supply for a CPU Unit to which an Expansion I/O Unit is not connected. Refer to the *CP1L CPU Unit Operation Manual* (Cat. No. W462) or *CP1H CPU Unit Operation Manual* (Cat. No. W450) for details.

CPU Unit Specifications

● Expansion Units and Expansion I/O Units

Unit name		Model	Current consumption	
			5 VDC	24 VDC
Expansion I/O Units	40 I/O points 24 inputs 16 outputs	CP1W-40EDR	0.080 A	0.090 A
		CP1W-40EDT	0.160 A	---
		CP1W-40EDT1		
	32 outputs	CP1W-32ER	0.049 A	0.131 A
		CP1W-32ET	0.113 A	---
		CP1W-32ET1		
	20 I/O points 12 inputs 8 outputs	CP1W-20EDR1	0.103 A	0.044 A
		CP1W-20EDT	0.130 A	---
		CP1W-20EDT1		
	16 outputs	CP1W-16ER	0.042 A	0.090 A
		CP1W-16ET	0.076 A	---
		CP1W-16ET1		
	8 inputs	CP1W-8ED	0.018 A	---
	8 outputs	CP1W-8ER	0.026 A	0.044 A
CP1W-8ET		0.075 A	---	
CP1W-8ET1				
Analog Input Unit	4 inputs	CP1W-AD041	0.100 A	0.090 A
Analog Output Unit	4 outputs	CP1W-DA041	0.080 A	0.124 A
	2 outputs	CP1W-DA021	0.095 A	0.040 A
Analog I/O Unit	2 inputs and 1 output	CP1W-MAD11	0.083 A	0.110 A
Temperature Sensor Units	K or J thermocouple inputs	CP1W-TS001	0.040 A	0.059 A
		CP1W-TS002		
	Pt or JPt platinum resistance thermometer inputs	CP1W-TS101	0.054 A	0.073 A
		CP1W-TS102		
CompoBus/S I/O Link Unit	8 inputs and 8 outputs	CP1W-SRT21	0.029 A	---

CPU Unit Specifications

■ Characteristics

● CP1H

Item	Type Models	CP1H-XA CPU Units	CP1H-X CPU Units	CP1H-Y CPU Units
		CP1H-XA□□□□-□	CP1H-X□□□□-□	CP1H-Y□□□□-□
Control method		Stored program method		
I/O control method		Cyclic scan with immediate refreshing		
Program language		Ladder diagram		
Function blocks		Maximum number of function block definitions: 128 Maximum number of instances: 256 Languages usable in function block definitions: Ladder diagrams, structured text (ST)		
Instruction length		1 to 7 steps per instruction		
Instructions		Approx. 500 (function codes: 3 digits)		
Instruction execution time		Basic instructions: 0.10 μs min. Special instructions: 0.15 μs min.		
Common processing time		0.7 ms		
Program capacity		20K steps		
Number of tasks		288 (32 cyclic tasks and 256 interrupt tasks)		
	Scheduled interrupt tasks	1 (interrupt task No. 2, fixed)		
	Input interrupt tasks	8 (interrupt task No. 140 to 147, fixed)	6 (interrupt task No. 140 to 145, fixed)	
		(Interrupt tasks can also be specified and executed for high-speed counter interrupts.)		
Maximum subroutine number		256		
Maximum jump number		256		
I/O areas (See note.)	Input bits	1,600 bits (100 words): CIO 0.00 to CIO 99.15 (The 24 built-in inputs are allocated in CIO 0.00 to CIO 0.11 and CIO 1.00 to CIO 1.11.)		
	Output bits	1,600 bits (100 words): CIO 100.00 to CIO 199.15 (The 16 built-in outputs are allocated in CIO 100.00 to CIO 100.07 and CIO 101.00 to CIO 101.07.)		
	Built-in Analog Inputs	CIO 200 to CIO 203	---	
	Built-in Analog Outputs	CIO 210 to CIO 211	---	
	Serial PLC Link Area	1,440 bits (90 words): CIO 3100.00 to CIO 3189.15 (CIO 3100 to CIO 3189)		
Work bits		8,192 bits (512 words): W0.00 to W511.15 (W0 to W511) CIO Area: 37,504 bits (2,344 words): CIO 3800.00 to CIO 6143.15 (CIO 3800 to CIO 6143)		
TR Area		16 bits: TR0 to TR15		
Holding Area		8,192 bits (512 words): H0.00 to H511.15 (H0 to H511)		
AR Area		Read-only (Write-prohibited): 7168 bits (448 words): A0.00 to A447.15 (A0 to A447) Read/Write: 8192 bits (512 words): A448.00 to A959.15 (A448 to A959)		
Timers		4,096 bits: T0 to T4095		
Counters		4,096 bits: C0 to C4095		
DM Area		32 Kwords: D0 to D32767		
Data Register Area		16 registers (16 bits): DR0 to DR15		
Index Register Area		16 registers (32 bits): IR0 to IR15		
Task Flag Area		32 flags (32 bits): TK0000 to TK0031		
Trace Memory		4,000 words (500 samples for the trace data maximum of 31 bits and 6 words.)		
Memory Cassette		A special Memory Cassette (CP1W-ME05M) can be mounted. Note: Can be used for program backups and auto-booting.		
Clock function		Supported. Accuracy (monthly deviation): -4.5 min to -0.5 min (ambient temperature: 55°C), -2.0 min to +2.0 min (ambient temperature: 25°C), -2.5 min to +1.5 min (ambient temperature: 0°C)		
Communications functions		One built-in peripheral port (USB 1.1): For connecting Support Software only.		
		A maximum of two Serial Communications Option Boards can be mounted.		
		A maximum of two Ethernet Option Boards can be mounted. When using CP1W-CIF41 Ver.1.0, one Ethernet Option Board can be mounted.		
Memory backup		Flash memory: User programs, parameters (such as the PLC Setup), comment data, and the entire DM Area can be saved to flash memory as initial values. Battery backup: The Holding Area, DM Area, and counter values (flags, PV) are backed up by a battery.		
Battery service life		5 years at 25°C. (Use the replacement battery within two years of manufacture.)		
Built-in input terminals		40 (24 inputs, 16 outputs)	20 (12 inputs, 8 outputs) Line-driver inputs: Two axes for phases A, B, and Z Line-driver outputs: Two axes for CW and CCW	
Number of connectable Expansion (I/O) Units		CP Expansion I/O Units: 7 max.; CJ-series Special I/O Units or CPU Bus Units: 2 max.		
Max. number of I/O points		320 (40 built in + 40 per Expansion (I/O) Unit × 7 Units)	300 (20 built in + 40 per Expansion (I/O) Unit × 7 Units)	
Interrupt inputs		8 inputs (Shared by the external interrupt inputs (counter mode) and the quick-response inputs.)		6 inputs (Shared by the external interrupt inputs (counter mode) and the quick-response inputs.)
Interrupt input counter mode		8 inputs (Response frequency: 5 kHz max. for all interrupt inputs), 16 bits Up or down counters		6 inputs (Response frequency: 5 kHz max. for all interrupt inputs), 16 bits Up or down counters
Quick-response inputs		8 points (Min. input pulse width: 50 μs max.)		6 points (Min. input pulse width: 50 μs max.)
Scheduled interrupts		1		

CPU Unit Specifications

Type		CP1H-XA CPU Units	CP1H-X CPU Units	CP1H-Y CPU Units
Item	Models	CP1H-XA□□□-□	CP1H-X□□□-□	CP1H-Y□□□-□
High-speed counters		4 inputs: Differential phases (4x), 50 kHz or Single-phase (pulse plus direction, up/down, increment), 100 kHz Value range: 32 bits, Linear mode or ring mode Interrupts: Target value comparison or range comparison		2 inputs: Differential phases (4x), 500 kHz or Single-phase, 1 MHz and 2 inputs: Differential phases (4x), 50 kHz or Single-phase (pulse plus direction, up/down, increment), 100 kHz Value range: 32 bits, Linear mode or ring mode Interrupts: Target value comparison or range comparison
Pulse outputs (models with transistor outputs only)	Pulse outputs	Trapezoidal or S-curve acceleration and deceleration (Duty ratio: 50% fixed) 4 outputs, 1 Hz to 100 kHz (CCW/CW or pulse plus direction)		Trapezoidal or S-curve acceleration and deceleration (Duty ratio: 50% fixed) 2 outputs, 1 Hz to 1 MHz (CCW/CW or pulse plus direction) 2 outputs, 1 Hz to 100 kHz (CCW/CW or pulse plus direction)
	PWM outputs	Duty ratio: 0.0% to 100.0% (Unit: 0.1%) 2 outputs, 0.1 to 6553.5 Hz (Accuracy: ±5% at 1 kHz)		
Built-in analog I/O terminals		4 analog inputs and 2 analog outputs	None	
Analog control		1 (Setting range: 0 to 255)		
External analog input		1 input (Resolution: 1/256, Input range: 0 to 10 V), not isolated		

Note: The memory areas for CJ-series Special I/O Units and CPU Bus Units are allocated at the same as for the CJ-series. For details, refer to the CJ Series catalog (Cat. No. P052).

● CP1L

Type		CP1L-M60 (60 points)	CP1L-M40 (40 points)	CP1L-M30 (30 points)	CP1L-L20 (20 points)	CP1L-L14 (14 points)	CP1L-L10 (10 points)
Item	Models	CP1L-M60□□□-□	CP1L-M40□□□-□	CP1L-M30□□□-□	CP1L-L20□□□-□	CP1L-L14□□□-□	CP1L-L10□□□-□
Control method		Stored program method					
I/O control method		Cyclic scan with immediate refreshing					
Program language		Ladder diagram					
Function blocks		Maximum number of function block definitions: 128 Maximum number of instances: 256 Languages usable in function block definitions: Ladder diagrams, structured text (ST)					
Instruction length		1 to 7 steps per instruction					
Instructions		Approx. 500 (function codes: 3 digits)					
Instruction execution time		Basic instructions: 0.55 μs min. Special instructions: 4.1 μs min.					
Common processing time		0.4 ms					
Program capacity		10K steps			5K steps		
Number of tasks		288 (32 cyclic tasks and 256 interrupt tasks)					
	Scheduled interrupt tasks	1 (interrupt task No. 2, fixed)					
	Input interrupt tasks	6 (interrupt task No. 140 to 145, fixed)				4 (interrupt task No. 140 to 143, fixed)	2 (interrupt task No. 140 to 141, fixed)
		(Interrupt tasks can also be specified and executed for high-speed counter interrupts and executed.)					
Maximum subroutine number		256					
Maximum jump number		256					
I/O areas	Input bits	36: CIO 0.00 to CIO 0.11, CIO 1.00 to CIO 1.11, and CIO 2.00 to CIO 2.11	24: CIO 0.00 to CIO 0.11 and CIO 1.00 to CIO 1.11	18: CIO 0.00 to CIO 0.11 and CIO 1.00 to CIO 1.05	12: CIO 0.00 to CIO 0.11	8: CIO 0.00 to CIO 0.07	6: CIO 0.00 to CIO 0.05
	Output bits	24: CIO 100.00 to CIO 100.07, CIO 101.00 to CIO 101.07, and CIO 102.00 to CIO 102.07	24: CIO 0.00 to CIO 0.11 and CIO 1.00 to CIO 1.11	12: CIO 100.00 to CIO 100.07 and CIO 101.00 to CIO 101.03	8: CIO 100.00 to CIO 100.07	6: CIO 100.00 to CIO 100.05	4: CIO 100.00 to CIO 100.03
	1:1 Link Area	1,024 bits (64 words): CIO 3000.00 to CIO 3063.15 (CIO 3000 to CIO 3063)					
	Serial PLC Link Area	1,440 bits (90 words): CIO 3100.00 to CIO 3189.15 (CIO 3100 to CIO 3189)					
Work bits		8,192 bits (512 words): W000.00 to W511.15 (W0 to W511) CIO Area: 37,504 bits (2,344 words): CIO 3800.00 to CIO 6143.15 (CIO 3800 to CIO 6143)					
TR Area		16 bits: TR0 to TR15					
Holding Area		8,192 bits (512 words): H0.00 to H511.15 (H0 to H511)					
AR Area		Read-only (Write-prohibited): 7168 bits (448 words): A0.00 to A447.15 (A0 to A447) Read/Write: 8192 bits (512 words): A448.00 to A959.15 (A448 to A959)					
Timers		4,096 bits: T0 to T4095					
Counters		4,096 bits: C0 to C4095					
DM Area		32 Kwords: D0 to D32767			10 Kwords: D0 to D9999, D32000 to D32767		
Data Register Area		16 registers (16 bits): DR0 to DR15					
Index Register Area		16 registers (32 bits): IR0 to IR15					
Task Flag Area		32 flags (32 bits): TK0000 to TK0031					
Trace Memory		4,000 words (500 samples for the trace data maximum of 31 bits and 6 words.)					
Memory Cassette		A special Memory Cassette (CP1W-ME05M) can be mounted. Note: Can be used for program backups and auto-booting.					

CPU Unit Specifications

Type	CP1L-M60 (60 points)	CP1L-M40 (40 points)	CP1L-M30 (30 points)	CP1L-L20 (20 points)	CP1L-L14 (14 points)	CP1L-L10 (10 points)	
Item	Models	CP1L-M60□□-□	CP1L-M40□□-□	CP1L-M30□□-□	CP1L-L20□□-□	CP1L-L14□□-□	CP1L-L10□□-□
Clock function	Supported. Accuracy (monthly deviation): -4.5 min to -0.5 min (ambient temperature: 55°C), -2.0 min to +2.0 min (ambient temperature: 25°C), -2.5 min to +1.5 min (ambient temperature: 0°C)						
Communications functions	One built-in peripheral port (USB 1.1): For connecting Support Software only.						
	A maximum of two Serial Communications Option Boards can be mounted.			A maximum of one Serial Communications Option Board can be mounted.		Not supported.	
Memory backup	Flash memory: User programs, parameters (such as the PLC Setup), comment data, and the entire DM Area can be saved to flash memory as initial values.						
	Battery backup: The Holding Area, DM Area, and counter values (flags, PV) are backed up by a battery.						
Battery service life	5 years at 25°C. (Use the replacement battery within two years of manufacture.)						
Built-in input terminals	60 (36 inputs, 24 outputs)	40 (24 inputs, 16 outputs)	30 (184 inputs, 12 outputs)	20 (12 inputs, 8 outputs)	14 (8 inputs, 6 outputs)	10 (6 inputs, 4 outputs)	
Number of connectable Expansion Units and Expansion I/O Units	CP-series Expansion Unit and Expansion I/O Units: 3 max.			CP-series Expansion Units and Expansion I/O Units: 1 max.		Not supported.	
Max. number of I/O points	180 (60 built in + 40 per Expansion (I/O) Unit × 3 Units)	160 (40 built in + 40 per Expansion (I/O) Unit × 3 Units)	150 (30 built in + 40 per Expansion (I/O) Unit × 3 Units)	60 (20 built in + 40 per Expansion (I/O) Unit × 1 Unit)	54 (14 built in + 40 per Expansion (I/O) Unit × 1 Unit)	10 (10 built in)	
Interrupt inputs	6 inputs (Response time: 0.3 ms)				4 inputs (Response time: 0.3 ms)	2 inputs (Response time: 0.3 ms)	
Interrupt inputs counter mode	6 inputs (Response frequency: 5 kHz max. for all interrupt inputs), 16 bits Up or down counters				4 inputs (Response frequency: 5 kHz max. for all interrupt inputs), 16 bits Up or down counters	2 inputs (Response frequency: 5 kHz max. for all interrupt inputs), 16 bits Up or down counters	
Quick-response inputs	6 points (Min. input pulse width: 50 μs max.)				4 points (Min. input pulse width: 50 μs max.)	2 points (Min. input pulse width: 50 μs max.)	
Scheduled interrupts	1						
High-speed counters	4 counters, 2 axes (24-VDC input) 4 inputs: Differential phases (4x), 50 kHz Single-phase (pulse plus direction, up/down, increment), 100 kHz Value range: 32 bits, Linear mode or ring mode Interrupts: Target value comparison or range comparison						
Pulse outputs (models with transistor outputs only)	Pulse outputs	Trapezoidal or S-curve acceleration and deceleration (Duty ratio: 50% fixed) 2 outputs, 1 Hz to 100 kHz (CCW/CW or pulse plus direction)					
	PWM outputs	Duty ratio: 0.0% to 100.0% (specified in increments of 0.1% or 1%) 2 outputs, 0.1 to 6553.5 Hz or 1 to 32,800 Hz (Accuracy: +1%/0% at 0.1 Hz to 10,000 Hz and +5%/0% at 10,000 Hz to 32,800 Hz)					
Analog control	1 (Setting range: 0 to 255)						
External analog input	1 input (Resolution: 1/256, Input range: 0 to 10 V). Not isolated.						

CPU Unit Specifications

Terminal Block Arrangement

● CP1H-XA and X CPU Units with AC Power Supply

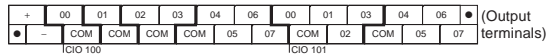

● CP1H-XA and X CPU Units with DC Power supply

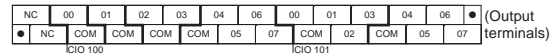

Built-in Input Area

● CP1H-XA and X CPU Units

PLC Setup	Input operation			High-speed counter operation	Pulse output origin search function set to be used.	
	Normal inputs	Interrupt inputs	Quick-response inputs	High-speed counters	Origin search	
CIO 0	00	Normal input 0	Interrupt input 0	Quick-response input 0	Pulse 0: Origin input signal	
	01	Normal input 1	Interrupt input 1	Quick-response input 1	High-speed counter 2 (phase-Z/reset)	Pulse 0: Origin proximity input signal
	02	Normal input 2	Interrupt input 2	Quick-response input 2	High-speed counter 1 (phase-Z/reset)	Pulse output 1: Origin input signal
	03	Normal input 3	Interrupt input 3	Quick-response input 3	High-speed counter 0 (phase-Z/reset)	Pulse output 1: Origin proximity input signal
	04	Normal input 4			High-speed counter 2 (phase-A, increment, or count input)	
	05	Normal input 5			High-speed counter 2 (phase-B, decrement, or direction input)	
	06	Normal input 6			High-speed counter 1 (phase-A, increment, or count input)	
	07	Normal input 7			High-speed counter 1 (phase-B, decrement, or direction input)	
	08	Normal input 8			High-speed counter 0 (phase-A, increment, or count input)	
	09	Normal input 9			High-speed counter 0 (phase-B, decrement, or direction input)	
	10	Normal input 10			High-speed counter 3 (phase-A, increment, or count input)	
11	Normal input 11			High-speed counter 3 (phase-B, decrement, or direction input)		
CIO 1	00	Normal input 12	Interrupt input 4	Quick-response input 4	High-speed counter 3 (phase-Z/reset)	Pulse output 2: Origin input signal
	01	Normal input 13	Interrupt input 5	Quick-response input 5		Pulse output 2: Origin proximity input signal
	02	Normal input 14	Interrupt input 6	Quick-response input 6		Pulse output 3: Origin input signal
	03	Normal input 15	Interrupt input 7	Quick-response input 7		Pulse output 3: Origin proximity input signal
	04	Normal input 16				
	05	Normal input 17				
	06	Normal input 18				
	07	Normal input 19				
	08	Normal input 20				
	09	Normal input 21				
	10	Normal input 22				
11	Normal input 23					

Built-in Output Area

● CP1H-XA and CP1H-X CPU Units

Instructions	When the instructions to the right are not executed	When a pulse output instruction (SPED, ACC, PLS2, or ORG) is executed		When the origin search function is set to be used in the PLC Setup, and an origin search is executed by the ORG instruction	When the PWM instruction is executed
		Fixed duty ratio pulse outputs			When the origin search function is used
PLC Setup	Normal outputs	CW/CCW	Pulse plus direction		PWM output
CIO 100	00	Normal output 0	Pulse output 0 (CW)	Pulse output 0 (pulse)	
	01	Normal output 1	Pulse output 0 (CCW)	Pulse output 1 (pulse)	
	02	Normal output 2	Pulse output 1 (CW)	Pulse output 0 (direction)	
	03	Normal output 3	Pulse output 1 (CCW)	Pulse output 1 (direction)	
	04	Normal output 4	Pulse output 2 (CW)	Pulse output 2 (pulse)	
	05	Normal output 5	Pulse output 2 (CCW)	Pulse output 2 (direction)	
	06	Normal output 6	Pulse output 3 (CW)	Pulse output 3 (pulse)	
07	Normal output 7	Pulse output 3 (CCW)	Pulse output 3 (direction)		
CIO 101	00	Normal output 8			PWM output 0
	01	Normal output 9			PWM output 1
	02	Normal output 10			Origin search 0 (Error counter reset output)
	03	Normal output 11			Origin search 1 (Error counter reset output)
	04	Normal output 12			Origin search 2 (Error counter reset output)
CIO 101	05	Normal output 13			Origin search 3 (Error counter reset output)
	06	Normal output 14			
	07	Normal output 15			

CPU Unit Specifications

Terminal Block Arrangement

CP1H-Y CPU Units

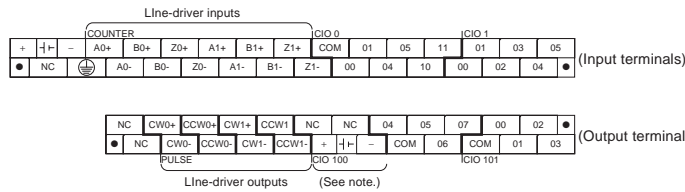

Note: Supply 24 VDC to the bottom 24 VDC input terminals when using bits 04 to 07 of output word CIO 100.

Built-in Input Area

CP1H-Y CPU Units

PLC Setup	Input operation setting			High-speed counter operation setting	Pulse output origin search function set to be used.	
	Normal inputs	Interrupt inputs	Quick-response inputs	High-speed counters	Origin search	
A0				High-speed counter 0 (phase-A, increment, or count input) fixed		
B0				High-speed counter 0 (phase-B, decrement, or direction input) fixed		
Z0				High-speed counter 0 (phase-Z/reset) fixed	Pulse 0: Origin input signal (line driver)	
A1				High-speed counter 1 (phase-A, increment, or count input) fixed		
B1				High-speed counter 1 (phase-B, decrement, or direction input) fixed		
Z1				High-speed counter 1 (phase-Z/reset) fixed	Pulse 1: Origin input signal (line driver)	
CIO 0	Bit 00	Normal input 0	Interrupt 0	Quick-response input 0	Pulse 2: Origin proximity input signal	
	Bit 01	Normal input 1	Interrupt 1	Quick-response input 1	High-speed counter 2 (phase-Z/reset)	
	Bit 04	Normal input 2			High-speed counter 2 (phase-A, increment, or count input)	
	Bit 05	Normal input 3			High-speed counter 2 (phase-B, decrement, or direction input)	
	Bit 10	Normal input 4			High-speed counter 3 (phase-A, increment, or count input)	
	Bit 11	Normal input 5			High-speed counter 2 (phase-B, decrement, or direction input)	Pulse 3: Origin proximity input signal
CIO 1	Bit 00	Normal input 6	Interrupt 2	Quick-response input 2	High-speed counter 2 (phase-Z/reset)	Pulse 3: Origin input signal
	Bit 01	Normal input 7	Interrupt 3	Quick-response input 3		Pulse 2: Origin input signal
	Bit 02	Normal input 8	Interrupt 4	Quick-response input 4		Pulse 1: Origin input signal (open collector)
	Bit 03	Normal input 9	Interrupt 5	Quick-response input 5		Pulse 0: Origin input signal (open collector)
	Bit 04	Normal input 10				Pulse 1: Origin proximity input signal
	Bit 05	Normal input 11				Pulse 0: Origin proximity input signal

These areas are for line-driver inputs, so they can be used only for high-speed counters (1 MHz) and not for other purposes, such as normal inputs.

Built-in Output Area

CP1H-Y CPU Units

Instructions	When the instructions to the right are not executed	When a pulse output instruction (SPED, ACC, PLS2, or ORG) is executed		When the origin search function is set to be used in the PLC Setup, and an origin search is executed by the ORG instruction	When the PWM instruction is executed
		Normal output	Fixed duty ratio pulse output		Variable duty ratio pulse output
PLC Setup		CW/CCW	Pulse plus direction	When the origin search function is used	PWM output
CW0	Not supported.	Pulse output 0 (CW) fixed	Pulse output 0 (pulse) fixed		
CCW0	Not supported.	Pulse output 0 (CCW) fixed	Pulse output 1 (pulse) fixed		
CW1	Not supported.	Pulse output 1 (CW) fixed	Pulse output 0 (direction) fixed		
CCW1	Not supported.	Pulse output 1 (CCW) fixed	Pulse output 1 (direction) fixed		
CIO 100	Bit 04	100.04	Pulse output 2 (CW)	Pulse output 2 (pulse)	
	Bit 05	100.05	Pulse output 2 (CCW)	Pulse output 2 (direction)	
	Bit 06	100.06	Pulse output 3 (CW)	Pulse output 3 (pulse)	
	Bit 07	100.07	Pulse output 3 (CCW)	Pulse output 3 (direction)	
CIO 101	Bit 00	101.00		Origin search 2 (Error counter reset output)	PWM output 0
	Bit 01	101.01		Origin search 3 (Error counter reset output)	PWM output 1
	Bit 02	101.02		Origin search 0 (Error counter reset output)	
	Bit 03	101.03		Origin search 1 (Error counter reset output)	

These areas are for line-driver inputs, so they can be used only for high-speed counters (1 MHz) and not for other purposes, such as normal inputs.

CPU Unit Specifications

Input Terminal Block Arrangement (Top Block)

● CP1L (60 Inputs)

- AC Power Supply Models

L1	L2/N	COM	01	03	05	07	09	11	01	03	05	07	09	11	01	03	05	07	09	11
			00	02	04	06	08	10	00	02	04	06	08	10	00	02	04	06	08	10

Inputs (CIO 0) Inputs (CIO 1) Inputs (CIO 2)

- DC Power Supply Models

+	-	COM	01	03	05	07	09	11	01	03	05	07	09	11	01	03	05	07	09	11
NC			00	02	04	06	08	10	00	02	04	06	08	10	00	02	04	06	08	10

Inputs (CIO 0) Inputs (CIO 1) Inputs (CIO 2)

● CP1L (40 Inputs)

- AC Power Supply Models

L1	L2/N	COM	01	03	05	07	09	11	01	03	05	07	09	11
			00	02	04	06	08	10	00	02	04	06	08	10

Inputs (CIO 0) Inputs (CIO 1)

- DC Power Supply Models

+	-	COM	01	03	05	07	09	11	01	03	05	07	09	11
NC			00	02	04	06	08	10	00	02	04	06	08	10

Inputs (CIO 0) Inputs (CIO 1)

● CP1L (30 inputs)

- AC Power Supply Models

L1	L2/N	COM	01	03	05	07	09	11	01	03	05	
			00	02	04	06	08	10	00	02	04	NC

Inputs (CIO 0) Inputs (CIO 1)

- DC Power Supply Models

+	-	COM	01	03	05	07	09	11	01	03	05	
NC			00	02	04	06	08	10	00	02	04	NC

Inputs (CIO 0) Inputs (CIO 1)

● CP1L (20 Inputs)

- AC Power Supply Models

L1	L2/N	COM	01	03	05	07	09	11
			00	02	04	06	08	10

Inputs (CIO 0)

- DC Power Supply Models

+	-	COM	01	03	05	07	09	11
NC			00	02	04	06	08	10

Inputs (CIO 0)

● CP1L (14 Inputs)

- AC Power Supply Models

L1	L2/N	COM	01	03	05	07	NC	NC
			00	02	04	06	NC	NC

Inputs (CIO 0)

- DC Power Supply Models

+	-	COM	01	03	05	07	NC	NC
NC			00	02	04	06	NC	NC

Inputs (CIO 0)

● CP1L (10 Inputs)

- AC Power Supply Models

L1	L2/N	COM	01	03	05
			00	02	04

Inputs (CIO 0)

- DC Power Supply Models

+	-	COM	01	03	05
NC			00	02	04

Inputs (CIO 0)

CPU Unit Specifications

■ Built-in Input Area

● CP1L

Number of inputs	Input terminal block		Input operation			High-speed counter operation		Origin search			
	Word	Bit	Normal inputs	Interrupt inputs	Quick-response inputs	Operation settings • High-speed counters enabled • Phase-Z signal reset		Origin searches enabled for pulse outputs 0 and 1			
						Single-phase (increment pulse input)	Two-phase (differential phase x4, up/down, or pulse plus direction)	CPU Units with 20 to 60 points	CPU Units with 14 points	CPU Units with 10 points	
10	CIO 0	00	Normal input 0	---	---	High-speed counter 0 (increment)	High-speed counter 0 (phase-A, increment, or count input)	---	---	---	
		01	Normal input 1	---	---	High-speed counter 1 (increment)	High-speed counter 0 (phase-B, decrement, or count input)	---	---	---	
		02	Normal input 2	---	---	---	High-speed counter 1 (phase-A, increment, or count input)	---	Pulse output 0: Origin proximity input signal	---	
		03	Normal input 3	---	---	---	High-speed counter 1 (phase-B, decrement, or count input)	---	Pulse output 1: Origin proximity input signal	Pulse output 0: Origin proximity input signal	
		04	Normal input 4	Interrupt input 0	---	Quick-response input 0	Counter 0, phase-Z/reset input	High-speed counter 0 (phase-Z/reset)	---	---	---
		05	Normal input 5	Interrupt input 1	---	Quick-response input 1	Counter 1, phase-Z/reset input	High-speed counter 1 (phase-Z/reset)	---	---	Pulse output 0: Origin input signal-
		06	Normal input 6	Interrupt input 2	---	Quick-response input 2	Counter 2, phase-Z/reset input	---	---	Pulse output 0: Origin input signal	---
		07	Normal input 7	Interrupt input 3	---	Quick-response input 3	Counter 3, phase-Z/reset input	---	---	Pulse output 1: Origin input signal	---
		08	Normal input 8	Interrupt input 4	---	Quick-response input 4	---	---	---	---	---
		09	Normal input 9	Interrupt input 5	---	Quick-response input 5	---	---	---	---	---
		10	Normal input 10	---	---	---	---	---	---	Pulse output 0: Origin proximity input signal	---
20	CIO 0	11	Normal input 11	---	---	---	---	---	Pulse output 1: Origin proximity input signal	---	
		to	to	to	to	to	to	to	to	to	
30	CIO 1	00	Normal input 12	---	---	---	---	---	---	---	
		05	Normal input 17	---	---	---	---	---	---	---	
40	CIO 1	06	Normal input 18	---	---	---	---	---	---	---	
		11	Normal input 23	---	---	---	---	---	---	---	
60	CIO 2	00	Normal input 24	---	---	---	---	---	---	---	
		to	to	to	to	to	to	to	to	to	
		11	Normal input 35	---	---	---	---	---	---	---	---

CPU Unit Specifications

Output Terminal Block Arrangement (Bottom Block)

● CP1L (60 Outputs)

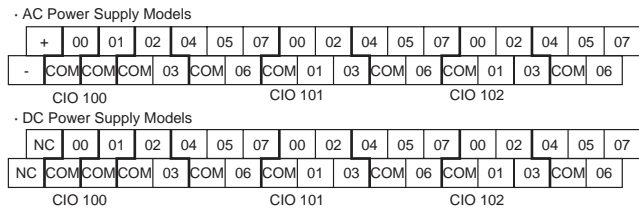

● CP1L (40 Outputs)

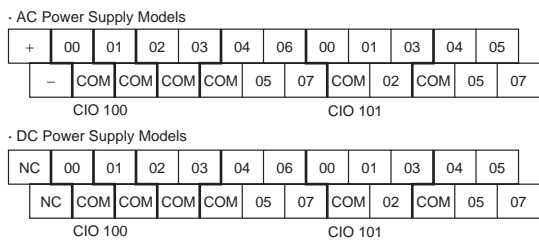

● CP1L (30 Outputs)

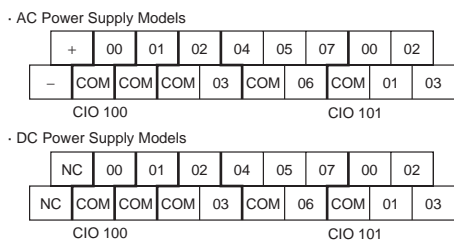

● CP1L (20 Outputs)

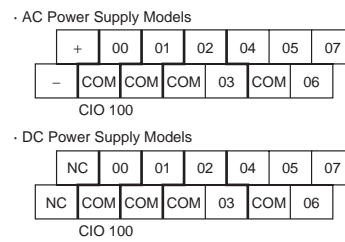

● CP1L (14 Outputs)

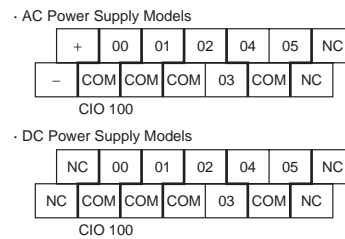

● CP1L (10 Outputs)

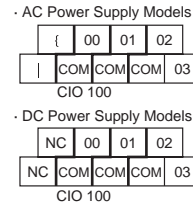

Built-in Output Area

● CP1L

Number of outputs	Output Terminal Block		When the instructions to the right are not executed	When a pulse output instruction (SPED, ACC, PLS2, or ORG) is executed	When the origin search function is set to be used in the PLC Setup, and an origin search is executed by the ORG instruction	When the PWM instruction is executed			
	Word	Bit	Normal output	Fixed duty ratio pulse output			Variable duty ratio pulse output		
				CW/CCW	Pulse plus direction	When the origin search function is used		PWM output	
				CPU Units with 14 to 60 points	CPU Units with 10 point				
10	CIO 100	00	Normal output 0	Pulse output 0 (CW)	Pulse output 0 (pulse)	---	---	---	
		01	Normal output 1	Pulse output 0 (CCW)	Pulse output 0 (direction)	---	---	PWM output 0	
		02	Normal output 2	Pulse output 1 (CW)	Pulse output 1 (pulse)	---	---	---	
		03	Normal output 3	Pulse output 1 (CCW)	Pulse output 1 (direction)	---	Origin search 0 (Error counter reset output)	---	PWM output 1
		04	Normal output 4	---	---	Origin search 0 (Error counter reset output)	---	---	
		05	Normal output 5	---	---	Origin search 1 (Error counter reset output)	---	---	
		06	Normal output 6	---	---	---	---	---	
30	CIO 101	07	Normal output 7	---	---	---	---	---	
		00	Normal output 8	---	---	---	---	---	
		to	to	to	to	to	to	to	
		03	Normal output 11	---	---	---	---	---	
40	CIO 101	04	Normal output 12	---	---	---	---	---	
		to	to	to	to	to	to	to	
		07	Normal output 15	---	---	---	---	---	
		01	Normal output 16	---	---	---	---	---	
60	CIO 102	to	to	to	to	to	to	to	
		07	Normal output 23	---	---	---	---	---	

CPU Unit Specifications

Input Specifications

ITEM	Specifications		
	High-speed counter inputs (phases A and B)	Interrupt inputs and quick-response inputs	Normal inputs
CP1L	CIO 0.00 to CIO 0.03	CIO 0.04 to CIO 0.09	CIO 0.10, CIO 0.11, CIO 1.00 to CIO 1.11, and CIO 2.00 to 2.11
CP1H-XA/X CPU Units	CIO 0.04 to CIO 0.11	CIO 0.00 to CIO 0.03 and CIO 1.00 to CIO 1.03	CIO 1.04 to CIO 1.11
CP1H-Y CPU Units	CIO 0.04, CIO 0.05, CIO 0.10, CIO 0.11	CIO 0.00, CIO 0.01 and CIO 1.00 to CIO 1.03	CIO 1.04, CIO 1.05
Input voltage	24 VDC +10%/-15%		
Applicable sensors	2-wire sensors or 3-wire sensors		
Input impedance	3.0 kΩ		4.7 kΩ
Input current	7.5 mA typical		5 mA typical
ON voltage	17.0 VDC min.		14.4 VDC min.
OFF voltage/current	1 mA max. at 5.0 VDC		
ON delay	2.5 μs max.	50 μs max.	1 ms max.
OFF delay	2.5 μs max.	50 μs max.	1 ms max.
Circuit configuration			

High-speed Counter Function Input Specifications

CP1L CPU Units (Input bits: CIO 0.00 to CIO 0.03)

CP1H-XA/X CPU Units (Input bits: CIO 0.04 to CIO 0.11)

CP1H-Y CPU Units (Input bits: CIO 0.04, CIO 0.05, CIO 0.10, CIO 0.11)

Item	Specifications
ON/OFF delay	<ul style="list-style-type: none"> Pulse plus direction input mode Increment mode Up/down input mode Differential phase input mode

Interrupt Input Counter Mode

CP1L CPU Units (Input bits: CIO 0.04 to CIO 0.09)

CP1H-XA/X CPU Units (Input bits: CIO 0.00 to CIO 0.03, CIO 1.00 to CIO 1.03)

CP1H-Y CPU Units (Input bits: CIO 0.00, CIO 0.11, CIO 1.00 to CIO 1.03)

Item	Specifications
ON/OFF delay	

High-speed Counter Inputs (Line-driver Inputs)

CP1H-Y CPU Units

Item	Specifications	
High-speed counter inputs	Phases A and B	Phase Z
Input voltage	RS-422A line-driver, AM26LS31 or equivalent Note: The power supply voltage on the line-driver must be 5 V±5% max.	
Input type	Line-driver input	
Input current	10 mA typical	13 mA typical
Circuit configuration		

CPU Unit Specifications

Item	Specifications
ON/OFF delay	<ul style="list-style-type: none"> Pulse plus direction input mode Increment mode Up/down input mode
	<ul style="list-style-type: none"> Differential phase input mode

Output Specifications

● CPU Units with Relay Outputs

Item	Specifications
Max. switching capacity	2 A, 250 VAC ($\cos\phi = 1$), 2 A, 24 VDC 4 A/common
Min. switching capacity	5 VDC, 10 mA
Service life of relay	Resistive load
	Inductive load
	Mechanical
ON delay	15 ms max.
OFF delay	15 ms max.
Circuit configuration	

Note: Under the worst conditions, the service life of output contacts is as shown on the left.

The service life of relays is as shown in the following diagram as a guideline.

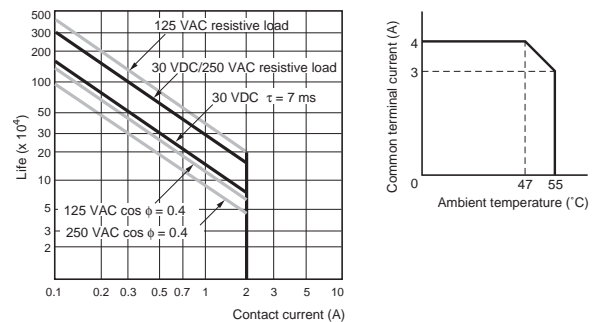

● CPU Units with Transistor Outputs (Sinking/Sourcing)

Item	Specifications		
CP1L CPU Units	CIO 100.00 to CIO 100.03	---	CIO 100.04 to CIO 101.07 CIO 102.00 to CIO 102.11
CP1H-XA/X CPU Units	CIO 100.00 to CIO 100.07	CIO 101.00, CIO 101.01	CIO 101.02 to CIO 101.07
CP1H-Y CPU Units	CIO 100.04 to CIO 100.07	CIO 101.00, CIO 101.01	CIO 101.02, CIO 101.03
Max. switching capacity	4.5 to 30 VDC: 300 mA/point, 0.9 A/common, 3.6 A/Unit (See notes 3 and 4.)		
Min. switching capacity	4.5 to 30 VDC, 1 mA		
Leakage current	0.1 mA max.		
Residual voltage	0.6 V max.	1.5 V max.	
ON delay	0.1 ms max.		
OFF delay	0.1 ms max.	1 ms max.	
Fuse	1/common (See note 2.)		
Circuit configuration	<p>Sinking Outputs</p> <p>Sourcing Outputs</p>	<p>Sinking Outputs</p> <p>Sourcing Outputs</p>	

Note: 1. Do not apply a voltage or connect a load to an output terminal exceeding the maximum switching capacity.

2. Fuses cannot be replaced by the user.

3. Also do not exceed 0.9 A for the total for CIO 100.00 to CIO 100.03. (CIO 100.00 to CIO 100.03 is different common.)

4. A maximum of 0.9 A per common can be switched at an ambient temperature of 50°C.

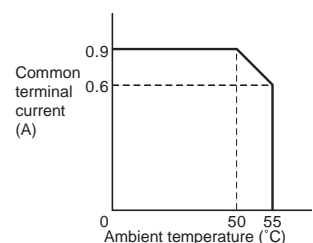

CPU Unit Specifications

● Pulse outputs

CP1L CPU Units: Output bits CIO 100.00 to CIO 100.03
 CP1H-XA/X CPU Units: Output bits CIO 100.00 to CIO 100.07
 CP1H-Y CPU Units: Output bits CIO100.04 to CIO 100.07

Item	Specifications
Max. switching capacity	30 mA at 4.75 to 26.4 VDC
Min. switching capacity	7 mA at 4.75 to 26.4 VDC
Max. output frequency	100 kHz
Output waveform	

- Note: 1.** The above values assume a resistive load and do not consider the impedance of the cable connecting the load.
2. The pulse widths during actual use may be smaller than the ones shown above due to pulse distortion caused by connecting cable impedance.
3. The OFF and ON refer to the output transistor. The output transistor is ON at level "L".

● Pulse Outputs (Line-driver Outputs)

CP1H-Y CPU Units

Item	Specifications
Pulse outputs	Line-driver outputs, Am26LS31 or equivalent
Max. output current	20 mA
Max. output frequency	1 MHz
Circuit configuration	

Note: Connect a load of 20 mA or less to the output. The Unit may be damaged if a current of more than 20 mA is output.

● Pulse outputs

CP1L CPU Units: Output bits CIO100.01, CIO 100.03
 CP1H-XA/X/Y CPU Units: Output bits CIO101.00, CIO 101.01

Item	Specifications
Max. switching capacity	30 mA at 4.75 to 26.4 VDC
Max. output frequency	CP1H: 1 kHz, CP1L: 32.8 kHz
PWM output precision	ON duty +5%, -0% at output frequency of 1 kHz
Output waveform	

- Note: 1.** The above values assume a resistive load and do not consider the impedance of the cable connecting the load.
2. The pulse widths during actual use may be smaller than the ones shown above due to pulse distortion caused by connecting cable impedance.
3. The OFF and ON refer to the output transistor. The output transistor is ON at level "L".

■ Analog I/O Specifications (CP1H-XA CPU Units Only)

Item		Voltage I/O	Current I/O
Analog Input Section	Number of analog inputs	4	
	Input signal range	0 to 5 V, 1 to 5 V, 0 to 10 V, or -10 to 10 V	0 to 20 mA or 4 to 20 mA
	Max. rated input	±15 V	±30 mA
	External input impedance	1 MΩ min.	Approx. 250 Ω
	Resolution	1/6,000 or 1/12,000 (full scale)	
	Overall accuracy	25°C: ±0.3% full scale/0 to 55°C: ±0.6% full scale	25°C: ±0.4% full scale/0 to 55°C: ±0.8% full scale
	A/D conversion data	Full scale for -10 to 10 V: F448 (E890) to 0BB8 (1770) hex Full scale for other ranges: 0000 to 1770 (2EE0) hex	
	Averaging	Supported (Set for individual inputs in the PLC Setup.)	
Analog Output Section	Open-circuit detection	Supported (Value when disconnected: 8000 Hex)	
	Number of outputs	2	
	Output signal range	0 to 5 V, 1 to 5 V, 0 to 10 V, -10 to 10 V	0 to 20 mA or 4 to 20 mA
	Allowable external output load resistance	1 kΩ min.	600 Ω max.
	External output impedance	0.5 Ω max.	---
	Resolution	1/6000 or 1/12000 (full scale)	
	Overall accuracy	25°C±0.4% of full scale, 0 to 55°C±0.8% of full scale	
D/A conversion data	Full scale for -10 to 10 V: F448 (E890) to 0BB8 (1770) hex Full scale for other ranges: 0000 to 1770 (2EE0) hex		
Conversion time	1 ms/point		
Isolation method	Photocoupler isolation between analog I/O terminals and internal circuits. No isolation between analog I/O signals.		

Built-in Analog Input Switch (Factory Settings)



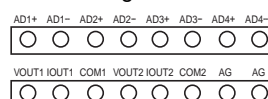

Built-in Analog I/O Terminal Block Arrangement



CPU Unit Specifications

Serial Communications Specifications (CP1W-CIF01/-CIF11)

Item	Applicable CPU Units				Function	Interface
	CP1H	CP1L-M Type	CP1L-L14/L20	CP1L-L10		
Peripheral USB port	Yes	Yes	Yes	Yes	For connecting Peripheral Device.	Conforms to USB 1.1, B-type connector
Serial port 1 (Option board slot 1)	Yes	Yes	Yes	---	Host Link, No-protocol, NT Link (1: N), Serial PLC Link (See note 1.), Serial Gateway (CompoWay/ F master, Modbus-RTU master), Modbus-RTU easy master function NT Link (1: 1) (See note 2.) 1: 1 Link (See note 2.)	The following can be used for either port. CP1W-CIF01 RS-232C Option Board 
Serial port 2 (Option board slot 2)	Yes	Yes	---	---		CP1W-CIF11 RS-422A/485 Option Board (Maximum transmission distance 50m) CP1W-CIF12 RS-422A/485(Isolated-type) Option Board (Maximum transmission distance 500m)  Can be used with either port.

Note: 1. Serial PLC Link can be used with either serial port 1 or serial port 2.
2. CP1L CPU Units only.

Ethernet Communications Specifications (CP1W-CIF41)

Item	Specifications		
Applicable PLCs	CP1H/CP1L CPU Units Note: The Ethernet Option Board cannot be used for the CP1L-L10.		
Number of Units that can be mounted	2 sets. (The CP1W-CIF41 Ver.1.0 and Ver.2.0 can be combined and used with one CPU Unit. When using CP1W-CIF41 Ver.1.0, only one unit can be mounted in an option board slot.)		
Transfer	Media access method	CSMA/CD	
	Modulation method	Baseband	
	Transmission paths	Star form	
	Baud rate	100 Mbit/s (100Base-TX), 10 Mbit/s (10Base-T)	
	Transmission media	100 Mbit/s	<ul style="list-style-type: none"> Unshielded twisted-pair (UDP) cable Categories: 5, 5e Shielded twisted-pair (STP) cable Categories: 100 Ω at 5, 5e
		10 Mbit/s	<ul style="list-style-type: none"> Unshielded twisted-pair (UDP) cable Categories: 3, 4, 5, 5e Shielded twisted-pair (STP) cable Categories: 100 Ω at 3, 4, 5, 5e
Transmission Distance	100 m (distance between hub and node)		

Item	FINS Communications Service Specifications	
Number of nodes	254	
Message length	1016 bytes max.	
Size of buffer	8k	
Communications Function	FINS Communications Service (UDP/IP, TCP/IP)	
FINS/UDP method	Protocol used	UDP/IP
	Port number	9600 (default) Can be changed.
	Protection	No
FINS/TCP method	Protocol used	TCP/IP
	Number of connections	Up to 2 simultaneous connections and only one connection can be set to client
	Port number	9600 (default) Can be changed.
	Protection	Yes (Specification of client IP addresses when unit is used as a server)

Note: 1. CX-Programmer version 8.1 or higher (CX-One version 3.1 or higher) is required.
2. Use CX-Integrator version 2.33 or higher (CX-One version 3.1 or higher) when the system needs to be set the routing tables. However, CX-Integrator does not support the other functions, using CP1W-CIF41, such as transferring the parameters and network structure.
3. To connect the CP1H/CP1L CPUs with the NS-series Programmable Terminals via Ethernet using CP1W-CIF41, make sure that the system version of NS Series is 8.2 or higher.

Option Unit Specifications

■ LDC Option Board (CP1W-DAM01)

● Specifications

Item	Function
Mounting port	CP1H/CP1L: Option board slot 1 Note: The LCD Option Board cannot be used for the CP1L-L10.
Communications protocol	Peripheral bus (Turn ON DIP switch pin 4.)
Weight	30 g max.
Number of display characters	4 rows × 12 characters: 48 characters max.
Display characters	5 × 7 dots (alphanumeric, Japanese kana, and symbols). Display switchable between Japanese katakana and English.
Backlight	Electroluminescence (EL): Normal: Lit green; Error: Flashing red

● LCD Functions

Operation	Description
Changing operating modes	Change the PLC operating mode without using the CX-Programmer.
I/O memory	Read and change the present values in the memory areas and force-set or force-reset bits.
PLC Setup operations	Read and change the PLC Setup.
Analog I/O monitor	Monitor the analog adjustment and present value for the external analog setting input.
Error log display	Read the log of errors that have occurred.
Memory cassette operation	Transfer and verify user programs between the PLC and memory cassette.
User monitor settings	Read the status of up to 16 words and bits with comments. You can use this setting to read data on the startup display.
Message display function settings	Display a user-set message of up to 48 characters on the LCD Option Board when a specified bit turns ON. A maximum of 16 screens can be registered for display.
Timers	<p>Day timer</p> <p>Use this timer for ON/OFF switching at a specified times every day from the starting day of the week to the ending day of the week. Sixteen timers can be set from timer 01 to timer 16.</p> <p>Operation:</p>
	<p>Weekly timer</p> <p>Use this timer for ON/OFF operation in intervals of one week that starts one day and ends another day. Sixteen timers can be set from timer No. 01 to timer No. 16.</p> <p>Operation:</p>
	<p>Calendar timer</p> <p>Use the calendar timers for ON or OFF operation in intervals of one year from the starting day to the ending day. Sixteen timers can be set from timer 01 to timer 16.</p> <p>Operation:</p>
Saving setting	Save the various settings that you set with the LCD Option Board to the DM Area of the PLC. You can also write the settings saved in the PLC to the LCD Option Board.
Language	Changing the display language (Japanese/English)
Other functions	<ul style="list-style-type: none"> • Setting the time of the PLC's built-in clock • Reading system data (e.g., unit version and lot number) • Setting the backlight lighting time • Adjusting LCD contrast • Reading cycle time (e.g., average, maximum, and minimum) • Clearing data for the LCD Option Board

Expansion I/O Unit Specifications

■ CP1W-40EDR/40EDT/40EDT1/32ER/32ET/32ET1/20EDR1/20EDT/20EDT1/16ER/16ET/16ET1/8ED/8ER/8ET/8ET1 Expansion I/O Units

Expansion I/O Units can be connected to the CPU Unit to configure the required number of I/O points.

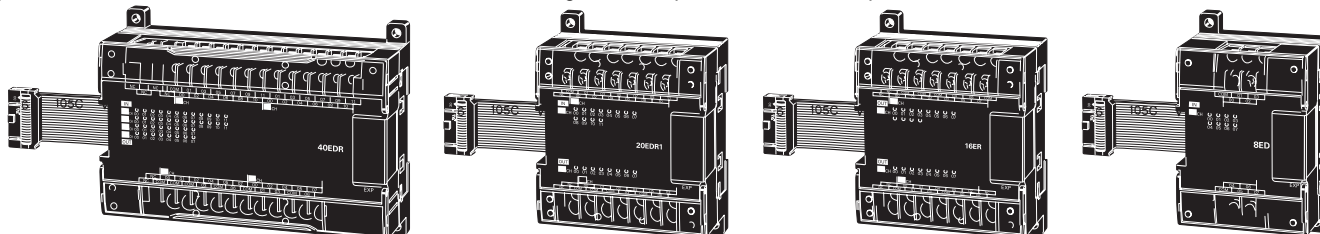

● DC Inputs (CP1W-40EDR/40EDT/40EDT1/20EDR1/20EDT/20EDT1/8ED)

Item	Specifications
Input voltage	24 VDC +10%/-15%
Input impedance	4.7 kΩ
Input current	5 mA typical
ON voltage	14.4 VDC min.
OFF voltage	5.0 VDC max.
ON delay	0 to 32 ms max. (Default: 8 ms) (See note 1.)
OFF delay	0 to 32 ms max. (Default: 8 ms) (See note 1.)
Circuit configuration	

Note: 1. Do not apply a voltage exceeding the rated voltage to an input terminal.
2. Can be set in the PLC Setup to 0, 0.5, 1, 2, 4, 8, 16 or 32 ms. The CP1W-40EDR/EDT/EDT1 are fixed at 16 ms.

● Relay Outputs (CP1W-40EDR/32ER/20EDR1/16ER/8ER)

Item	Specifications	
Max. switching capacity	2 A, 250 VAC (cosφ = 1), 24 VDC 4 A/common	
Min. switching capacity	5 VDC, 10 mA	
Service life of relay	Resistive load	150,000 operations (24 VDC)
	Inductive load	100,000 operations (24 VAC cos φ = 0.4)
	Mechanical	20,000,000 operations
ON delay	15 ms max.	
OFF delay	15 ms max.	
Circuit configuration		

Note: Under the worst conditions, the service life of output contacts is as shown on the left. The service life of relays is as shown in the following diagram as a guideline.

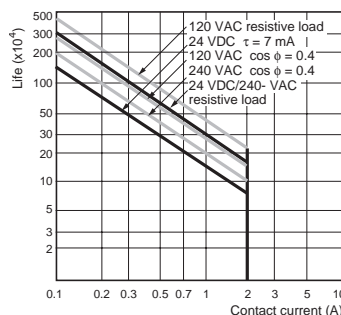

Switching frequency: 1,800 operations/h

Relationship between Output Load Current and Ambient Temperature (CP1W-16ER/32ER)

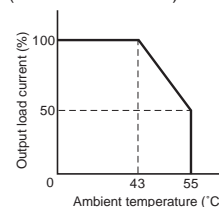

When using the CP1W-32ER, do not allow more than 24 outputs to be ON simultaneously regardless of the ambient temperature.

Expansion I/O Unit Specifications

● Transistor Outputs (Sinking/Sourcing) (CP1W-40EDT/-40EDT1/-32ET/-32ET1/-20EDT/-20EDT1/-16ET/-16ET1/-8ET/-8ET1)

Item	Specifications				
	CP1W-40EDT CP1W-40EDT1	CP1W-32E CP1W-32ET1	CP1W-20EDT CP1W-20EDT1	CP1W-16ET CP1W-16ET1	CP1W-8ET CP1W-8ET1
Max. switching capacity (See note 3.)	4.5 to 30 VDC: 0.3 A/point		24 VAC +10%/ -5%: 0.3 A/point	4.5 to 30 VDC: 0.3 A/point	
	0.9 A/common 3.6 A/common		0.9 A/common 1.8 A/common	0.9 A/common 3.6 A/common	0.9 A/common 1.8 A/common
Leakage current	0.1 mA max.				
Residual voltage	1.5 V max.				
ON delay	0.1 ms max.				
OFF delay	1 ms max. at 24 VDC +10%/-5%, 5 to 300 mA				
Fuse (See note 2.)	1/common				
Circuit configuration	Sinking Outputs		Sourcing Outputs		

- Note:**
1. Do not apply a voltage or connect a load to an output terminal exceeding the maximum switching capacity.
 2. The fuses cannot be replaced by the user.
 3. A maximum of 0.9 A per common can be switched at an ambient temperature of 50°C.

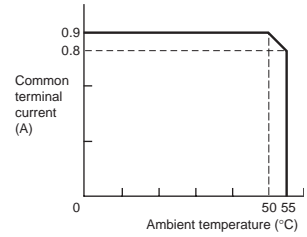

Expansion Unit Specifications

■ CP1W-AD041/DA041/DA021/MAD11 Analog Units

Analog values that are input are converted to binary data and stored in the input area, or binary data is output as analog values.

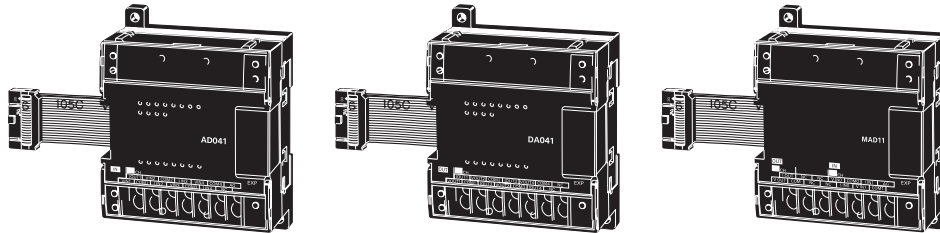

■ Analog Input Unit: CP1W-AD041

Model		CP1W-AD041	
Item		Input voltage	Input current
Number of inputs		4	
Input signal range		0 to 5 V, 1 to 5 V, 0 to 10 V, -10 to 10 V	0 to 20 mA 4 to 20 mA
Max. rated input		±15 V	±30 mA
External input impedance		1 MΩ min.	Approx. 250 Ω
Resolution		6000	
Overall accuracy	25°C	±0.3% of full scale	±0.4% of full scale
	0 to 55°C	±0.6% of full scale	±0.8% of full scale
Conversion time		2.0 ms/point	
A/D conversion data		Binary data with resolution of 6,000 Full scale for -10 to 10 V: F448 to 0BB8 hex Full scale for other ranges: 0000 to 1770 hex	
Averaging		Supported.	
Open-circuit detection		Supported.	
Insulation resistance		20 MΩ min. (at 250 VDC, between isolated circuits)	
Dielectric strength		500 VAC for 1 min (between isolated circuits)	
Isolation method		Photocoupler isolation (between analog inputs and secondary internal circuits). No isolation between input signals.	

■ Analog Output Unit: CP1W-DA041/DA021

Model		CP1W-DA041/DA021	
Item		Input voltage	Input current
Number of outputs		DA041: 4, DA021: 2	
Output signal range		0 to 5 V, 0 to 10 V, or -10 to 10 V	0 to 20 mA or 4 to 20 mA
Allowable external output load resistance		2 kΩ min.	350 Ω max.
External output impedance		0.5 Ω max.	---
Resolution		6000	
Overall accuracy	25°C	±0.4% of full scale	
	0 to 55°C	±0.8% of full scale	
Conversion time		2.0 ms/point	
D/A conversion data		Binary data with resolution of 6,000 Full scale for -10 to 10 V: F448 to 0BB8 hex Full scale for other ranges: 0000 to 1770 hex	
Insulation resistance		20 MΩ min. (at 250 VDC between isolated circuits)	
Dielectric strength		500 VAC for 1 min between isolated circuits	
Isolation method		Photocoupler isolation between analog inputs and secondary internal circuits. No isolation between analog input signals.	

■ Analog I/O Unit: CP1W-MAD11

Model		CP1W-MAD11		
Item		Voltage I/O	Current I/O	
Analog Input Section	Number of inputs	2 inputs		
	Input signal range	0 to 5 V, 1 to 5V, 0 to 10 V, or -10 to 10V		
	Max. rated input	±15 V		
	External input impedance	1 MΩ min.		
	Resolution	1/6000 (full scale)		
	Overall accuracy	25°C	±0.3% of full scale	
		0 to 55°C	±0.6% of full scale	
A/D conversion data		Binary data (hexadecimal, 4 digits) -10 to 10 V: F448 to 0BB8 hex Full scale for other ranges: 0000 to 1770 hex		
Analog Output Section (See note 1.)	Averaging	Supported (Set for each input using a DIP switch.)		
	Disconnection detection	Supported		
	Number of outputs	1 output		
	Output signal range	1 to 5 V, 0 to 10 V, -10 to 10 V	0 to 20 mA, 4 to 20 mA	
	External output max. current	---		
	Allowable external output load resistance	1 kΩ min.	600 Ω max.	
	External input impedance	0.5 Ω max.		
	Resolution	1/6000 (full scale)		
	Overall accuracy	25°C	±0.4% of full scale	
		0 to 55°C	±0.8% of full scale	
Data setting		---		
D/A conversion data		Binary data (hexadecimal, 4 digits) -10 to 10 V: F448 to 0BB8 hex Full scale for other ranges: 0000 to 1770 hex		
Conversion time (See note 2.)		2 ms/point (6 ms for all points)		
Isolation method		Photocoupler isolation between analog I/O and internal circuits (There is no isolation between the analog I/O signals.)		

Note: 1. The voltage output and current output can be used at the same time for analog outputs, but the total output current must not exceed 21 mA.

Note: 2. The conversion time is the total time for 2 analog inputs and 1 analog output.

Expansion Unit Specifications

Temperature Sensor Units: CP1W-TS001/TS002/TS101/TS102

By mounting a Temperature Sensor Unit to the PLC, inputs can be obtained from thermocouples or platinum resistance thermometers, and temperature measurements can be converted to binary data (4-digit hexadecimal) and stored in the input area of the CPU Unit.

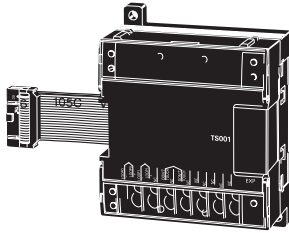

Specifications

Item	Model	CP1W-TS001/002	CP1W-TS101/102
Number of inputs		2 (TS001), 4 (TS002)	2 (TS101), 4 (TS102)
Input types		K, J switchable (Note: Same for all inputs.)	Pt100, JPt100 switchable (Note: Same for all inputs.)
Indication accuracy		(The larger of the indicated value: $\pm 0.5\%$ and $\pm 2^\circ\text{C}$ (See note.)) ± 1 digit max.	(The larger of the indicated value: $\pm 0.5\%$ and $\pm 1^\circ\text{C}$) ± 1 digit max.
Conversion time		250 ms/2 points (TS001, TS101); 250 ms/4 points (TS002, TS102)	
Converted temperature data		Binary (4-digit hexadecimal)	
Isolation method		Photocoupler isolation between the temperature input signals.	

Note: The indication accuracy when using a K-type thermocouple for temperature less than -100°C is $\pm 4^\circ\text{C} \pm 1$ digit max.

Input Temperature Ranges for CP1W-TS001/002 (The rotary switch can be used to make the following range and input type settings.)

Input type	Range ($^\circ\text{C}$)	Range ($^\circ\text{F}$)
K	-200 to 1300	-300 to 2300
	0.0 to 500.0	0.0 to 900.0
J	-100 to 850	-100 to 1500
	0.0 to 400.0	0.0 to 750.0

Input Temperature Ranges for CP1W-TS101/102 (The rotary switch can be used to make the following range and input type settings.)

Input type	Range ($^\circ\text{C}$)	Range ($^\circ\text{F}$)
Pt100	-200.0 to 650.0	-300 to 1200.0
JPt100	-200.0 to 650.0	-300 to 1200.0

CP1W-SRT21 CompoBus/S I/O Link Unit

The CompoBus/S I/O Link Unit functions as a slave for a CompoBus/S Master Unit (or an SRM1 CompoBus/S Master Control Unit) to form an I/O Link with 8 inputs and 8 outputs between the CompoBus/S I/O Link Unit and the Master Unit.

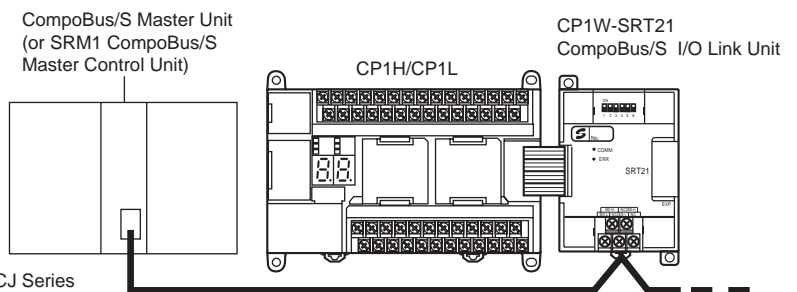
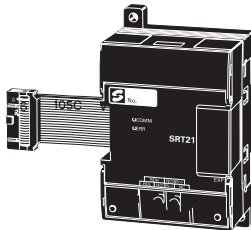

CS/CJ Series
C200H□ Series
CQM1(H) Series
SRM1 Series
CPM2C-S Series

Special flat cable or VCTF cable

A maximum of 16 Units can be connected
(or 8 Units for CQM1-SRM21-V1).

Specifications

Item	Model	CP1W-SRT21
Master/Slave		CompoBus/S Slave
Number of I/O bits		8 input bits, 8 output bits
Number of words occupied in CP1H/CP1L I/O memory		1 input word, 1 output word (Allocated in the same way as for other Expansion Units)
Node number setting		Set using the DIP switch (before the CPU Unit is turned ON.)

Dimensions

Dimensions

(Unit: mm)

■ CPU Units

CP1H CPU Units (X/XA/Y Types)

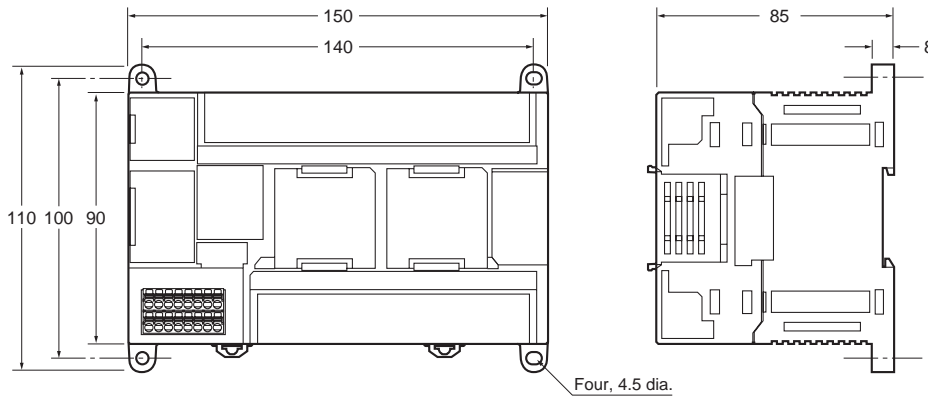

Weight:
 CP1H-□□□-A (AC power supply):
 740 g max.
 CP1H-□□□-D DC power supply):
 590 g max.

CP1L CPU Units with 60 I/O Points

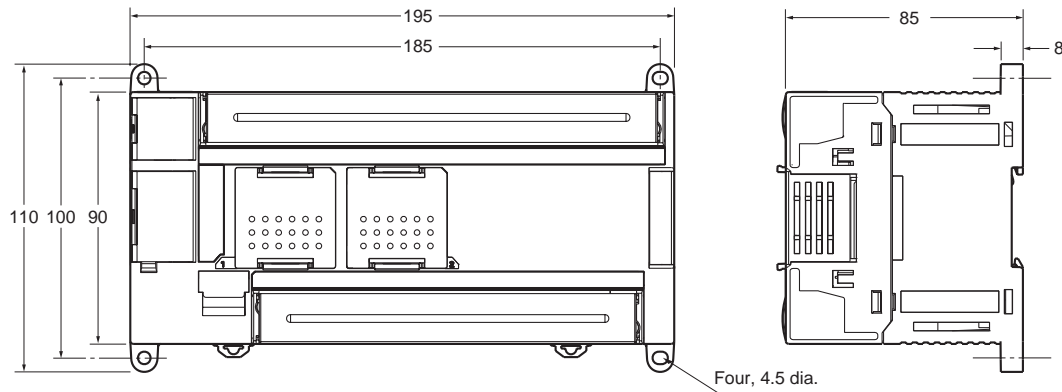

Weight:
 820 g max.

CP1L CPU Units with 40 I/O Points

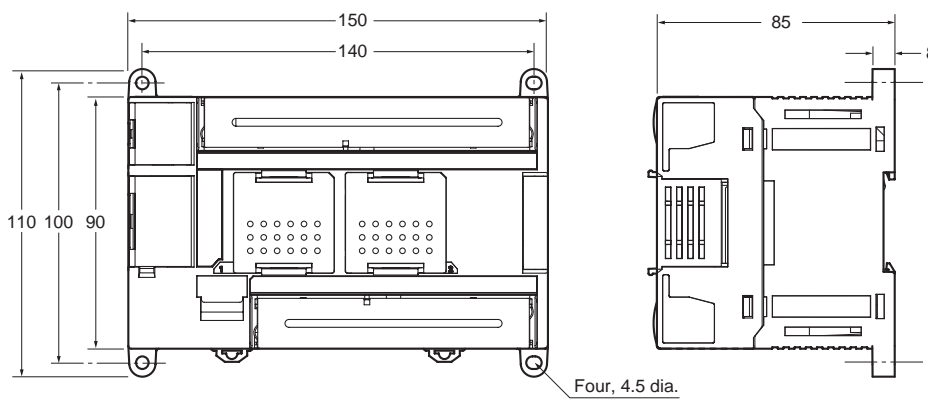

Weight:
 675 g max.

CP1L CPU Units with 30 I/O Points

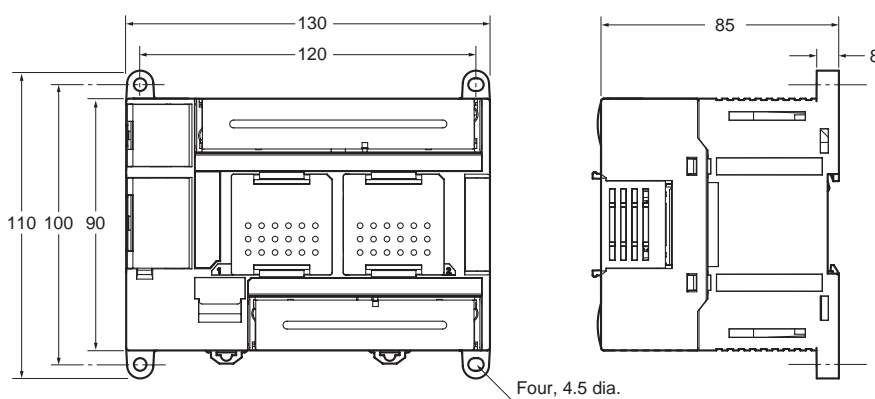

Weight:
 610 g max.

Dimensions

CP1L CPU Units with 14 or 20 I/O Points

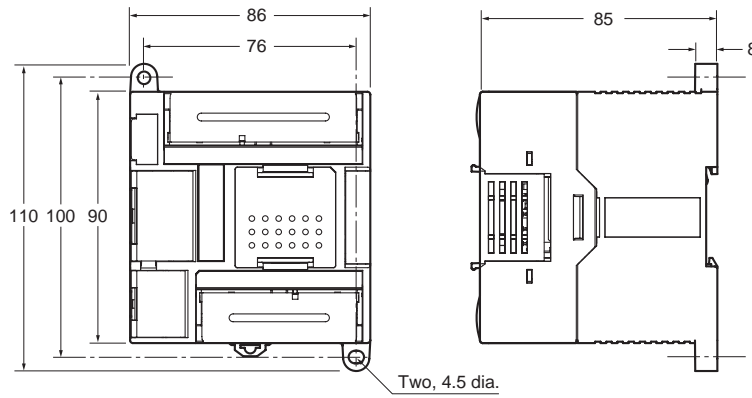

Weight:
380 g max.

CP1L CPU Units with 10 I/O Points

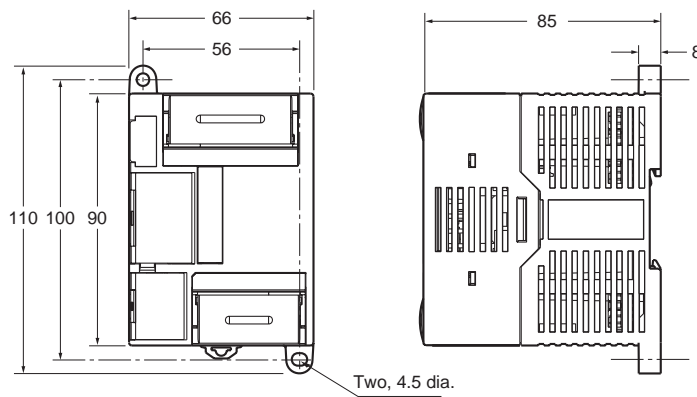

Weight:
300 g max.

Dimensions

Expansion Units and Expansion I/O Units

CP1W-20ED□
 CP1W-16E□□
 CP1W-AD041/CP1W-DA041/CP1W-DA021
 CP1W-MAD11/CP1W-TS□□□

CP1W-8E□□
 CP1W-SRT21

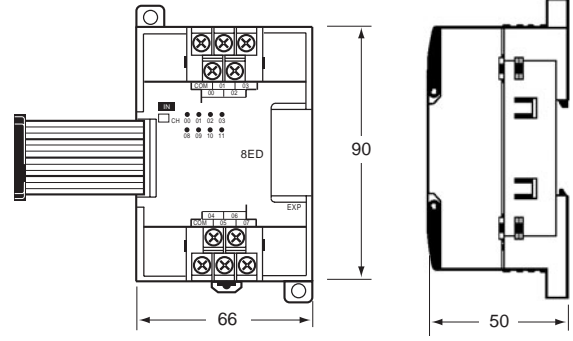
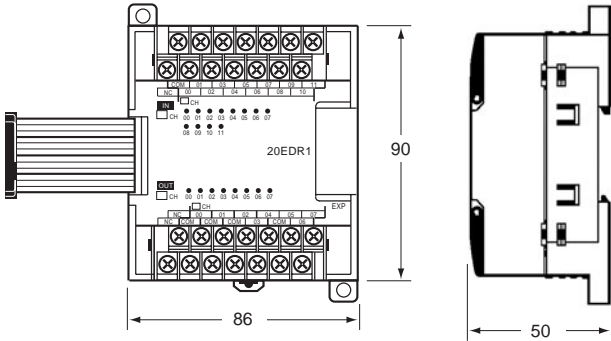

CP1W-40ED□
 CP1W-32E□□

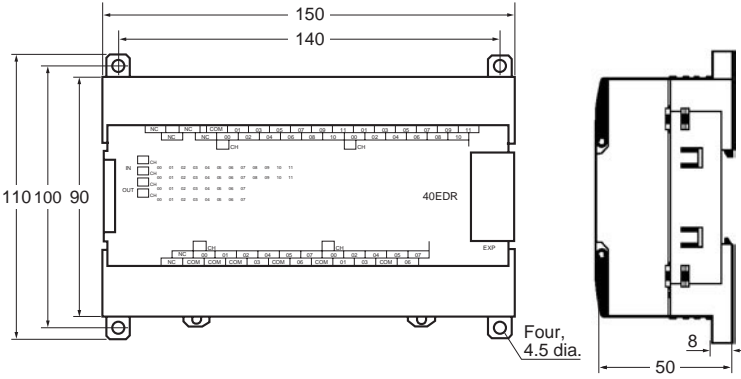

Unit name	Model number	Weight
Expansion I/O Units	CP1W-40ER	380 g
	CP1W-40EDT/-40EDT1	320 g
	CP1W-32ER	465 g
	CP1W-32ET/-32ET1	325 g
	CP1W-20EDR1/-20EDT/-20EDT1	300 g
	CP1W-16ER	280 g
	CP1W-16ET/-16ET1	225 g
	CP1W-8ED	200 g
Analog Units	CP1W-AD041/-DA041/-DA021	200 g
	CP1W-MAD11	150 g
Temperature Sensor Units	CP1W-TS001/-TS002/-TS101/-TS102	250 g
CompoBus/S I/O Link Unit	CP1W-SRT21	200 g

CJ-series Special I/O Units and CPU Bus Units

CJ Unit Adaptor

CP1W-EXT01

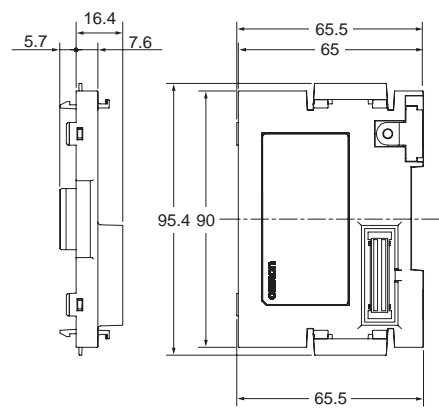
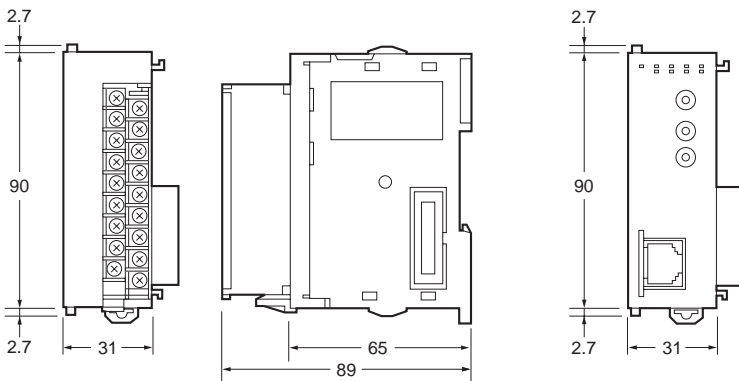

CP1H

Example: Two CJ-series Units (31-mm widths) Connected Using a CJ Unit Adaptor

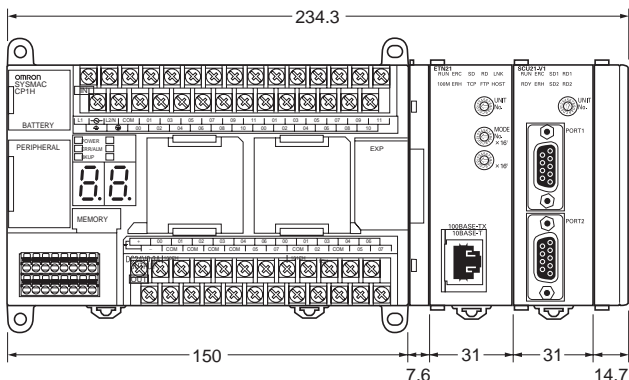

A Wealth of Instructions

Floating-point Decimal Instructions, Trigonometric Instruction, and More

Just like the CS/CJ-series PLCs, the CP1H and CP1L have approximately 500 instructions for ladder programming.

Example: PID Instructions with Autotuning

Autotuning of PID constants is enabled using the PID CONTROL instruction. The limit cycle method is used for tuning, so tuning is completed in a short time.

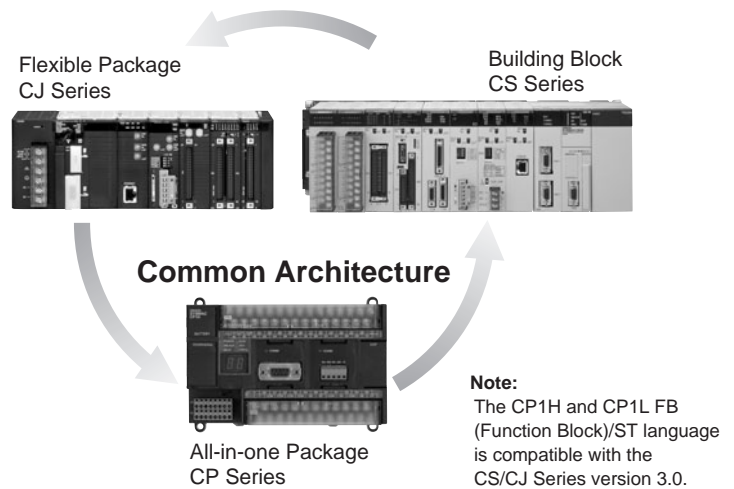

● Sequence Input Instructions

Instruction	Mnemonic	Function code
LOAD	LD	---
LOAD NOT	LD NOT	---
AND	AND	---
AND NOT	AND NOT	---
OR	OR	---
OR NOT	OR NOT	---
AND LOAD	AND LD	---
OR LOAD	OR LD	---
NOT	NOT	520
CONDITION ON	UP	521
CONDITION OFF	DOWN	522
LOAD BIT TEST	LD TST	350
LOAD BIT TEST NOT	LD TSTN	351
AND BIT TEST	AND TST	350
AND BIT TEST NOT	AND TSTN	351
OR BIT TEST	OR TST	350
OR BIT TEST NOT	OR TSTN	351

● Sequence Output Instructions

Instruction	Mnemonic	Function code
OUTPUT	OUT	---
OUTPUT NOT	OUT NOT	---
KEEP	KEEP	011
DIFFERENTIATE UP	DIFU	013
DIFFERENTIATE DOWN	DIFD	014
SET	SET	---
RESET	RSET	---
MULTIPLE BIT SET	SETA	530
MULTIPLE BIT RESET	RSTA	531
SINGLE BIT SET	SETB	532
SINGLE BIT RESET	RSTB	533
SINGLE BIT OUTPUT	OUTB	534

● Sequence Control Instructions

Instruction	Mnemonic	Function code
END	END	001
NO OPERATION	NOP	000
INTERLOCK	IL	002
INTERLOCK CLEAR	ILC	003
MULTI-INTERLOCK DIFFERENTIATION HOLD	MILH	517
MULTI-INTERLOCK DIFFERENTIATION RELEASE	MILR	518
MULTI-INTERLOCK CLEAR	MILC	519
JUMP	JMP	004
JUMP END	JME	005
CONDITIONAL JUMP	CJP	510
CONDITIONAL JUMP NOT	CJPN	511
MULTIPLE JUMP	JMP0	515
MULTIPLE JUMP END	JME0	516
FOR LOOP	FOR	512
BREAK LOOP	BREAK	514
NEXT LOOPS	NEXT	513

● Timer and Counter Instructions

Instruction	Mnemonic	Function code
TIMER	BCD TIM	---
	BIN TIMX	550
COUNTER	BCD CNT	---
	BIN CNTX	546
HIGH-SPEED TIMER	BCD TIMH	015
	BIN TIMHX	551
ONE-MS TIMER	BCD TMHH	540
	BIN TMHHX	552
ACCUMULATIVE TIMER	BCD TTIM	087
	BIN TTIMX	555
LONG TIMER	BCD TIML	542
	BIN TIMLX	553
MULTI-OUTPUT TIMER	BCD MTIM	543
	BIN MTIMX	554
REVERSIBLE COUNTER	BCD CNTR	012
	BIN CNTRX	548
RESET TIMER/COUNTER	BCD CNR	545
	BIN CNRX	547

● Data Comparison Instructions

Instruction	Mnemonic	Function code
Symbol Comparison (Unsigned)	LD, AND, OR + =, <	300 (=)
	>, <, < =, >, > =	305 (< >)
		310 (<)
		315 (< =)
		320 (>)
Symbol Comparison (Double-word, unsigned)	LD, AND, OR + =, <	301 (=)
	>, <, < =, >, > = + L	306 (< >)
		311 (<)
		316 (< =)
		321 (>)
Symbol Comparison (Signed)	LD, AND, OR + =, <	302 (=)
	>, <, < =, >, > = + S	307 (< >)
		312 (<)
		317 (< =)
		322 (>)
Symbol Comparison (Double-word, signed)	LD, AND, OR + =, <	303 (=)
	>, <, < =, >, > = + SL	308 (< >)
		313 (<)
		318 (< =)
		323 (>)
Time Comparison	LD, AND, OR + =	341 (= DT)
	DT, < > DT, < DT, < = DT, > DT, > = DT	342 (< > DT)
		343 (< DT)
		344 (< = DT)
		345 (> DT)
		346 (> = DT)
COMPARE	CMP	020
DOUBLE COMPARE	CMPL	060
SIGNED BINARY COMPARE	CPS	114
DOUBLE SIGNED BINARY COMPARE	CPSL	115
TABLE COMPARE	TCMP	085
MULTIPLE COMPARE	MCMP	019
UNSIGNED BLOCK COMPARE	BCMP	068
EXPANDED BLOCK COMPARE	BCMP2	502
AREA RANGE COMPARE	ZCP	088
DOUBLE AREA RANGE COMPARE	ZCPL	116

Instructions

● Data Movement Instructions

Instruction	Mnemonic	Function code
MOVE	MOV	021
DOUBLE MOVE	MOVL	498
MOVE NOT	MVN	022
DOUBLE MOVE NOT	MVNL	499
MOVE BIT	MOVB	082
MOVE DIGIT	MOVD	083
MULTIPLE BIT TRANSFER	XFRB	062
BLOCK TRANSFER	XFER	070
BLOCK SET	BSET	071
DATA EXCHANGE	XCHG	073
DOUBLE DATA EXCHANGE	XCGL	562
SINGLE WORD DISTRIBUTE	DIST	080
DATA COLLECT	COLL	081
MOVE TO REGISTER	MOVR	560
MOVE TIMER/COUNTER PV TO REGISTER	MOVRW	561

● Data Shift Instructions

Instruction	Mnemonic	Function code
SHIFT REGISTER	SFT	010
REVERSIBLE SHIFT REGISTER	SFTR	084
ASYNCHRONOUS SHIFT REGISTER	ASFT	017
WORD SHIFT	WSFT	016
ARITHMETIC SHIFT LEFT	ASL	025
DOUBLE SHIFT LEFT	ASLL	570
ARITHMETIC SHIFT RIGHT	ASR	026
DOUBLE SHIFT RIGHT	ASRL	571
ROTATE LEFT	ROL	027
DOUBLE ROTATE LEFT	ROLL	572
ROTATE LEFT WITHOUT CARRY	RLNC	574
DOUBLE ROTATE LEFT WITHOUT CARRY	RLNL	576
ROTATE RIGHT	ROR	028
DOUBLE ROTATE RIGHT	RORL	573
ROTATE RIGHT WITHOUT CARRY	RRNC	575
DOUBLE ROTATE RIGHT WITHOUT CARRY	RRNL	577
ONE DIGIT SHIFT LEFT	SLD	074
ONE DIGIT SHIFT RIGHT	SRD	075
SHIFT N-BIT DATA LEFT	NSFL	578
SHIFT N-BIT DATA RIGHT	NSFR	579
SHIFT N-BITS LEFT	NASL	580
DOUBLE SHIFT N-BITS LEFT	NSLL	582
SHIFT N-BITS RIGHT	NASR	581
DOUBLE SHIFT N-BITS RIGHT	NSRL	583

● Increment/Decrement Instructions

Instruction	Mnemonic	Function code
INCREMENT BINARY	++	590
DOUBLE INCREMENT BINARY	++L	591
DECREMENT BINARY	--	592
DOUBLE DECREMENT BINARY	--L	593
INCREMENT BCD	++B	594
DOUBLE INCREMENT BCD	++BL	595
DECREMENT BCD	--B	596
DOUBLE DECREMENT BCD	--BL	597

● Symbol Math Instructions

Instruction	Mnemonic	Function code
SIGNED BINARY ADD WITHOUT CARRY	+	400
DOUBLE SIGNED BINARY ADD WITHOUT CARRY	+L	401
SIGNED BINARY ADD WITH CARRY	+C	402
DOUBLE SIGNED BINARY ADD WITH CARRY	+CL	403
BCD ADD WITHOUT CARRY	+B	404
DOUBLE BCD ADD WITHOUT CARRY	+BL	405
BCD ADD WITH CARRY	+BC	406
DOUBLE BCD ADD WITH CARRY	+BCL	407
SIGNED BINARY SUBTRACT WITHOUT CARRY	-	410
DOUBLE SIGNED BINARY SUBTRACT WITHOUT CARRY	-L	411
SIGNED BINARY SUBTRACT WITH CARRY	-C	412
DOUBLE SIGNED BINARY SUBTRACT WITH CARRY	-CL	413
BCD SUBTRACT WITHOUT CARRY	-B	414
DOUBLE BCD SUBTRACT WITHOUT CARRY	-BL	415
BCD SUBTRACT WITH CARRY	-BC	416
DOUBLE BCD SUBTRACT WITH CARRY	-BCL	417
SIGNED BINARY MULTIPLY	*	420
DOUBLE SIGNED BINARY MULTIPLY	* L	421
UNSIGNED BINARY MULTIPLY	* U	422
DOUBLE UNSIGNED BINARY MULTIPLY	* UL	423
BCD MULTIPLY	* B	424
DOUBLE BCD MULTIPLY	* BL	425
SIGNED BINARY DIVIDE	/	430

Instruction	Mnemonic	Function code
DOUBLE SIGNED BINARY DIVIDE	/L	431
UNSIGNED BINARY DIVIDE	/U	432
DOUBLE UNSIGNED BINARY DIVIDE	/UL	433
BCD DIVIDE	/B	434
DOUBLE BCD DIVIDE	/BL	435

● Data Conversion Instructions

Instruction	Mnemonic	Function code
BCD-TO-BINARY	BIN	023
DOUBLE BCD-TO-DOUBLE BINARY	BINL	058
BINARY-TO-BCD	BCD	024
DOUBLE BINARY-TO-DOUBLE BCD	BCDL	059
2'S COMPLEMENT	NEG	160
DOUBLE 2'S COMPLEMENT	NEGL	161
16-BIT TO 32-BIT SIGNED BINARY	SIGN	600
DATA DECODER	MLPX	076
DATA ENCODER	DMPX	077
ASCII CONVERT	ASC	086
ASCII TO HEX	HEX	162
COLUMN TO LINE	LINE	063
LINE TO COLUMN	COLM	064
SIGNED BCD-TO-BINARY	BINS	470
DOUBLE SIGNED BCD-TO-BINARY	BISL	472
SIGNED BINARY-TO-BCD	BCDS	471
DOUBLE SIGNED BINARY-TO-BCD	BDSL	473
GRAY CODE CONVERSION	GRY	474

● Special Math Instructions

Instruction	Mnemonic	Function code
BINARY ROOT	ROTB	620
BCD SQUARE ROOT	ROOT	072
ARITHMETIC PROCESS	APR	069
FLOATING POINT DIVIDE	FDIV	079
BIT COUNTER	BCNT	067

● Logic Instructions

Instruction	Mnemonic	Function code
LOGICAL AND	ANDW	034
DOUBLE LOGICAL AND	ANDL	610
LOGICAL OR	ORW	035
DOUBLE LOGICAL OR	ORWL	611
EXCLUSIVE OR	XORW	036
DOUBLE EXCLUSIVE OR	XORL	612
EXCLUSIVE NOR	XNRW	037
DOUBLE EXCLUSIVE NOR	XNRL	613
COMPLEMENT	COM	029
DOUBLE COMPLEMENT	COML	614

Instructions

● Floating-point Math Instructions

Instruction	Mnemonic	Function code
FLOATING TO 16-BIT	FIX	450
FLOATING TO 32-BIT	FIXL	451
16-BIT TO FLOATING	FLT	452
32-BIT TO FLOATING	FLTL	453
FLOATING-POINT ADD	+F	454
FLOATING-POINT SUBTRACT	-F	455
FLOATING- POINT MULTIPLY	*F	456
FLOATING- POINT DIVIDE	/F	457
DEGREES TO RADIANS	RAD	458
RADIANS TO DEGREES	DEG	459
SINE	SIN	460
COSINE	COS	461
TANGENT	TAN	462
ARC SINE	ASIN	463
ARC COSINE	ACOS	464
ARC TANGENT	ATAN	465
SQUARE ROOT	SQRT	466
EXPONENT	EXP	467
LOGARITHM	LOG	468
EXPONENTIAL POWER	PWR	840
Floating Symbol Comparison	LD, AND, OR + = F, < > F, < F, < = F, > F, > = F	329 (= F) 330 (< > F) 331 (< F) 332 (< = F) 333 (> F) 334 (> = F)
FLOATING- POINT TO ASCII	FSTR	448
ASCII TO FLOATING-POINT	FVAL	449

● Double-precision Floating-point Instructions

Instruction	Mnemonic	Function code
DOUBLE FLOATING TO 16-BIT BINARY	FIXD	841
DOUBLE FLOATING TO 32-BIT BINARY	FIXLD	842
16-BIT BINARY TO DOUBLE FLOATING	DBL	843
32-BIT BINARY TO DOUBLE FLOATING	DBLL	844
DOUBLE FLOATINGPOINT ADD	+D	845
DOUBLE FLOATING-POINT SUBTRACT	-D	846
DOUBLE FLOATING-POINT MULTIPLY	*D	847
DOUBLE FLOATING-POINT DIVIDE	/D	848
DOUBLE DEGREES TO RADIANS	RADD	849
DOUBLE RADIANS TO DEGREES	DEGD	850
DOUBLE SINE	SIND	851
DOUBLE COSINE	COSD	852
DOUBLE TANGENT	TAND	853
DOUBLE ARC SINE	ASIND	854
DOUBLE ARC COSINE	ACOSD	855

Instruction	Mnemonic	Function code
DOUBLE ARC TANGENT	ATAND	856
DOUBLE SQUARE ROOT	SQRTD	857
DOUBLE EXPONENT	EXPD	858
DOUBLE LOGARITHM	LOGD	859
DOUBLE EXPONENTIAL POWER	PWRD	860
DOUBLE SYMBOL COMPARISON	LD, AND, OR + = D, < > D, < D, < = D, > D, > = D	335 (= D) 336 (< > D) 337 (< D) 338 (< = D) 339 (> D) 340 (> = D)

● Table Data Processing Instructions

Instruction	Mnemonic	Function code
SET STACK	SSET	630
PUSH ONTO STACK	PUSH	632
FIRST IN FIRST OUT	FIFO	633
LAST IN FIRST OUT	LIFO	634
DIMENSION RECORD TABLE	DIM	631
SET RECORD LOCATION	SETR	635
GET RECORD NUMBER	GETR	636
DATA SEARCH	SRCH	181
SWAP BYTES	SWAP	637
FIND MAXIMUM	MAX	182
FIND MINIMUM	MIN	183
SUM	SUM	184
FRAME CHECKSUM	FCS	180
STACK SIZE READ	SNUM	638
STACK DATA READ	SREAD	639
STACK DATA OVERWRITE	SWRIT	640
STACK DATA INSERT	SINS	641
STACK DATA DELETE	SDEL	642

● Data Control Instructions

Instruction	Mnemonic	Function code
PID CONTROL	PID	190
PID CONTROL WITH AUTO TUNING	PIDAT	191
LIMIT CONTROL	LMT	680
DEAD BAND CONTROL	BAND	681
DEAD ZONE CONTROL	ZONE	682
TIME-PROPORTIONAL OUTPUT	TPO	685
SCALING	SCL	194
SCALING 2	SCL2	486
SCALING 3	SCL3	487
AVERAGE	AVG	195

● Subroutine Instructions

Instruction	Mnemonic	Function code
SUBROUTINE CALL	SBS	091
SUBROUTINE ENTRY	SBN	092
SUBROUTINE RETURN	RET	093
MACRO	MCRO	099

Instruction	Mnemonic	Function code
GLOBAL SUBROUTINE CALL	GSBN	751
GLOBAL SUBROUTINE ENTRY	GRET	752
GLOBAL SUBROUTINE RETURN	GSBS	750

● Interrupt Control Instructions

Instruction	Mnemonic	Function code
SET INTERRUPT MASK	MSKS	690
READ INTERRUPT MASK	MSKR	692
CLEAR INTERRUPT	CLI	691
DISABLE INTERRUPTS	DI	693
ENABLE INTERRUPTS	EI	694

● High-speed Counter and Pulse Output Instructions

Instruction	Mnemonic	Function code
MODE CONTROL	INI	880
HIGH-SPEED COUNTER PV READ	PRV	881
COUNTER FREQUENCY CONVERT	PRV2	883
COMPARISON TABLE LOAD	CTBL	882
SPEED OUTPUT	SPED	885
SET PULSES	PULS	886
PULSE OUTPUT	PLS2	887
ACCELERATION CONTROL	ACC	888
ORIGIN SEARCH	ORG	889
PULSE WITH VARIABLE DUTY FACTOR	PWM	891

● Step Instructions

Instruction	Mnemonic	Function code
STEP DEFINE	STEP	008
STEP START	SNXT	009

● Basic I/O Unit Instructions

Instruction	Mnemonic	Function code
I/O REFRESH	IORF	097
7-SEGMENT DECODER	SDEC	078
DIGITAL SWITCH INPUT	DSW	210
TEN KEY INPUT	TKY	211
HEXADECIMAL KEY INPUT	HKY	212
MATRIX INPUT	MTR	213
7-SEGMENT DISPLAY OUTPUT	7SEG	214
INTELLIGENT I/O READ	IORD	222
INTELLIGENT I/O WRITE	IOWR	223
CPU BUS I/O REFRESH	DLNK	226

Instructions

● Serial Communications Instructions

Instruction	Mnemonic	Function code
PROTOCOL MACRO	PMCR	260
TRANSMIT	TXD	236
RECEIVE	RXD	235
TRANSMIT VIA SERIAL COMMUNICATIONS UNIT	TXDU	256
RECEIVE VIA SERIAL COMMUNICATIONS UNIT	RXDU	255
CHANGE SERIAL PORT SETUP	STUP	237

● Network Instructions

Instruction	Mnemonic	Function code
NETWORK SEND	SEND	090
NETWORK RECEIVE	RECV	098
DELIVER COMMAND	CMND	490
EXPLICIT MESSAGE SEND	EXPLT	720
EXPLICIT GET ATTRIBUTE	EGATR	721
EXPLICIT SET ATTRIBUTE	ESATR	722
EXPLICIT WORD READ	ECHRD	723
EXPLICIT WORD WRITE	ECHWR	724

● Display Instructions

Instruction	Mnemonic	Function code
DISPLAY MESSAGE	MSG	046
7-SEGMENT LED WORD DATA DISPLAY	SCH	047
7-SEGMENT LED CONTROL	SCTRL	048

● Clock Instructions

Instruction	Mnemonic	Function code
CALENDAR ADD	CADD	730
CALENDAR SUBTRACT	CSUB	731
HOURS TO SECONDS	SEC	065
SECONDS TO HOURS	HMS	066
CLOCK ADJUSTMENT	DATE	735

● Debugging Instructions

Instruction	Mnemonic	Function code
TRACE MEMORY SAMPLING	TRSM	045

● Failure Diagnosis Instructions

Instruction	Mnemonic	Function code
FAILURE ALARM	FAL	006
SEVERE FAILURE ALARM	FALS	007
FAILURE POINT DETECTION	FPD	269

● Other Instructions

Instruction	Mnemonic	Function code
SET CARRY	STC	040
CLEAR CARRY	CLC	041
EXTEND MAXIMUM CYCLE TIME	WDT	094
SAVE CONDITION FLAGS	CCS	282
LOAD CONDITION FLAGS	CCL	283
CONVERT ADDRESS FROM CS	FRMCV	284
CONVERT ADDRESS TO CV	TOCV	285

● Block Programming Instructions

Instruction	Mnemonic	Function code	
BLOCK PROGRAM BEGIN	BPRG	096	
BLOCK PROGRAM END	BEND	801	
BLOCK PROGRAM PAUSE	BPPS	811	
BLOCK PROGRAM RESTART	BPRS	812	
CONDITIONAL BLOCK EXIT	CCS	282	
CONDITIONAL BLOCK EXIT	CONDITON EXIT	806	
CONDITIONAL BLOCK EXIT	EXIT Bit operand	806	
CONDITIONAL BLOCK EXIT (NOT)	EXIT NOT Bit operand	806	
CONDITIONAL BLOCK BRANCHING	CONDITON IF	802	
CONDITIONAL BLOCK BRANCHING	IF Bit operand	802	
CONDITIONAL BLOCK BRANCHING (NOT)	IF NOT Bit operand	802	
CONDITIONAL BLOCK BRANCHING (ELSE)	ELSE	803	
CONDITIONAL BLOCK BRANCHING END	IEND	804	
ONE CYCLE AND WAIT	CONDITON WAIT	805	
ONE CYCLE AND WAIT	WAIT Bit operand	805	
ONE CYCLE AND WAIT (NOT)	WAIT NOT Bit operand	805	
TIMER WAIT	BCD	TIMW	813
	BIN	TIMWX	816
COUNTER WAIT	BCD	CNTW	814
	BIN	CNTWX	817
HIGH-SPEED TIMER WAIT	BCD	TMHW	815
	BIN	TMHWX	818
LOOP	LOOP	809	

● Block Programming Instructions

Instruction	Mnemonic	Function code
LEND	CONDITON LEND	810
LEND	LEND Bit operand	810
LEND NOT	LEND NOT Bit operand	810

● Text String Processing Instructions

Instruction	Mnemonic	Function code
MOV STRING	MOV\$	664
CONCATENATE STRING	+\$	656
GET STRING LEFT	LEFT\$	652
GET STRING RIGHT	RGHT\$	653
GET STRING MIDDLE	MID\$	654
FIND IN STRING	FIND\$	660
STRING LENGTH	LEN\$	650
REPLACE IN STRING	RPLC\$	661
DELETE STRING	DEL\$	658
EXCHANGE STRING	XCHG\$	665
CLEAR STRING	CLR\$	666
INSERT INTO STRING	INS\$	657
String Comparison	LD, AND, OR + = \$, < > \$, < > \$, < = \$, > \$, > = \$	670 (= \$) 671 (< > \$) 672 (< \$) 673 (< = \$) 674 (> \$) 675 (> = \$)

● Task Control Instructions

Instruction	Mnemonic	Function code
TASK ON	TKON	820
TASK OFF	TKOF	821

● Model Conversion Instructions

Instruction	Mnemonic	Function code
BLOCK TRANSFER	XFERC	565
SINGLE WORD DISTRIBUTE	DISTC	566
DATA COLLECT	COLLC	567
MOVE BIT	MOVBC	568
BIT COUNTER	BCNTC	621

● Special Instructions for Function Blocks

Instruction	Mnemonic	Function code
GET VARIABLE ID	GETID	286

Ordering Information

■ CPU Units	56
■ Options for CPU Units	57
■ Programming Devices	58
■ Expansion Units	59
■ I/O Connecting Cable	59
■ Optional Products, Maintenance Products and DIN Track Accessories	59
■ CJ-series Special I/O Units and CPU Bus Units	60

Standards and Directives

● International Standards

- The standards are abbreviated as follows: U: UL, U1: UL (Class 1 Division 2 Products for Hazardous Locations), C: CSA, UC: cULus, UC1: cULus (Class 1 Division 2 Products for Hazardous Locations), CU: cUL, N: NK, L: Lloyd, and CE: EC Directives.
- Contact your OMRON representative for further details and applicable conditions for these standards.

● EC Directives

The EC Directives applicable to PLCs include the EMC Directives and the Low Voltage Directive. OMRON complies with these directives as described below.

● EMC Directives

Applicable Standards

EMI: EN61000-6-4

EMS: EN61131-2 and EN61000-6-2 (See note.)

PLCs are electrical devices that are incorporated in machines and manufacturing installations. OMRON PLCs conform to the related EMC standards so that the devices and machines into which they are built can more easily conform to EMC standards. The actual PLCs have been checked to ensure conformity to EMC standards. Whether these standards are satisfied for the actual system, however, must be checked by the customer.

EMC-related performance will vary depending on the configuration, wiring, and other conditions of the equipment or control panel in which the PLC is installed. The customer must, therefore, perform final checks to confirm that the overall machine or device conforms to EMC standards.

Note: The applicable EMS standards depend on the product.

● Low Voltage Directive

Applicable Standard: EN61131-2

Devices that operate at voltages from 50 to 1,000 VAC or 75 to 150 VDC must satisfy the appropriate safety requirements. With PLCs, this applies to Power Supply Units and I/O Units that operate in these voltage ranges.

These Units have been designed to conform to EN61131-2, which is the applicable standard for PLCs.

Ordering Information

■ CPU Units

● CP1H CPU Units

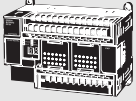
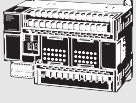
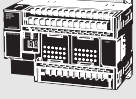
CPU Unit	Specifications					Model	Standards
	CPU type	Power supply	Output method	Inputs	Outputs		
CP1H-X CPU Units 	Memory capacity: 20K steps High-speed counters: 100 kHz, 4 axes Pulse outputs: 100 kHz, 4 axes (Models with transistor outputs only)	AC power supply	Relay output	24	16	CP1H-X40DR-A CP1H-X40DT-D CP1H-X40DT1-D	UC1, N, L, CE
		DC power supply	Transistor output (sinking)				
			Transistor output (sourcing)				
CP1H-XA CPU Units 	Memory capacity: 20K steps High-speed counters: 100 kHz, 4 axes Pulse outputs: 100 kHz, 4 axes (Models with transistor outputs only) Analog inputs: 4 Analog outputs: 2	AC power supply	Relay output	24	16	CP1H-XA40DR-A CP1H-XA40DT-D CP1H-XA40DT1-D	UC1, N, L, CE
		DC power supply	Transistor output (sinking)				
			Transistor output (sourcing)				
CP1H-Y CPU Units 	Memory capacity: 20K steps High-speed counters: 1 MHz, 2 axes 100 kHz, 2 axes Pulse outputs: 1 MHz, 2 axes 100 kHz, 2 axes	DC power supply	Transistor output (sinking)	12 + line-driver input, 2 axes	8 + line-driver output, 2 axes	CP1H-Y20DT-D	



Note: 1. CP1H PLCs are supported by CX-Programmer version 6.2 or higher.

2. Purchase a separately sold Option Unit if you will use RS-232C, RS-422A/485, Ethernet, or LCD.

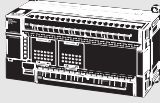
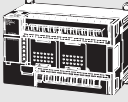
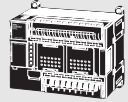
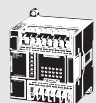
● CP1L CPU Units







CPU Unit	Specifications					Model	Standards
	CPU type	Power supply	Output method	Inputs	Outputs		
CP1L-M CPU Units with 60 Points 	Memory capacity: 10K steps High-speed counters: 100 kHz, 4 axes Pulse outputs: 100 kHz, 2 axes (Models with transistor outputs only)	AC power supply	Relay output	36	24	CP1L-M60DR-A CP1L-M60DT-A CP1L-M60DR-D CP1L-M60DT-D CP1L-M60DT1-D	UC1, N, L, CE
			Transistor output (sinking)				
		DC power supply	Relay output				
			Transistor output (sinking)				
			Transistor output (sourcing)				
CP1L-M CPU Units with 40 Points 	Memory capacity: 10K steps High-speed counters: 100 kHz, 4 axes Pulse outputs: 100 kHz, 2 axes (Models with transistor outputs only)	AC power supply	Relay output	24	16	CP1L-M40DR-A CP1L-M40DT-A CP1L-M40DR-D CP1L-M40DT-D CP1L-M40DT1-D	UC1, N, L, CE
			Transistor output (sinking)				
		DC power supply	Relay output				
			Transistor output (sinking)				
			Transistor output (sourcing)				
CP1L-M CPU Units with 30 Points 	Memory capacity: 10K steps High-speed counters: 100 kHz, 4 axes Pulse outputs: 100 kHz, 2 axes (Models with transistor outputs only)	AC power supply	Relay output	18	12	CP1L-M30DR-A CP1L-M30DT-A CP1L-M30DR-D CP1L-M30DT-D CP1L-M30DT1-D	UC1, N, L, CE
			Transistor output (sinking)				
		DC power supply	Relay output				
			Transistor output (sinking)				
			Transistor output (sourcing)				
CP1L-L CPU Units with 20 Points 	Memory capacity: 5K steps High-speed counters: 100 kHz, 4 axes Pulse outputs: 100 kHz, 2 axes (Models with transistor outputs only)	AC power supply	Relay output	12	8	CP1L-L20DR-A CP1L-L20DT-A CP1L-L20DR-D CP1L-L20DT-D CP1L-L20DT1-D	UC1, N, L, CE
			Transistor output (sinking)				
		DC power supply	Relay output				
			Transistor output (sinking)				
			Transistor output (sourcing)				

Ordering Information

CPU Unit	Specifications					Model	Standards
	CPU type	Power supply	Output method	Inputs	Outputs		
CP1L-L CPU Units with 14 Points 	Memory capacity: 5K steps High-speed counters: 100 kHz, 4 axes Pulse outputs: 100 kHz, 2 axes (Models with transistor outputs only)	AC power supply	Relay output	8	6	CP1L-L14DR-A	UC1, N, L, CE
			Transistor output (sinking)			CP1L-L14DT-A	
		DC power supply	Relay output			CP1L-L14DR-D	
			Transistor output (sinking)			CP1L-L14DT-D	
			Transistor output (sourcing)			CP1L-L14DT1-D	
CP1L-L CPU Units with 10 Point 	Memory capacity: 5K steps High-speed counters: 100 kHz, 4 axes Pulse outputs: 100 kHz, 2 axes (Models with transistor outputs only)	AC power supply	Relay output	6	4	CP1L-L10DR-A	UC1, N, L, CE
			Transistor output (sinking)			CP1L-L10DT-A	
		DC power supply	Relay output			CP1L-L10DR-D	
			Transistor output (sinking)			CP1L-L10DT-D	
			Transistor output (sourcing)			CP1L-L10DT1-D	

- Note: 1.** CP1L PLCs are supported by CX-Programmer version 7.2 or higher, except for 10-point and 60-point CPU Units. The 10-point and 60-point CPU Units are supported by CX-Programmer version 7.3 or higher. Update The CX-Programmer version automatically from the website using CX-Programmer version 7.0 (included with CX-One version 2.0).
- 2.** Purchase an Option Unit (sold separately) if you will use RS-232C, RS-422A/485, Ethernet, or LCD.

Options for CPU Units

Name	Specifications	Model	Standards
RS-232C Option Board 	Can be mounted in either CPU Unit Option Board slot 1 or 2. Note: Cannot be used for the CP1L-L10.	CP1W-CIF01	UC1, N, L, CE
RS-422A/485 Option Board 		CP1W-CIF11	
RS-422A/485 (Isolated-type) Option Board 		CP1W-CIF12	UC1, N, L, CE
Ethernet Option Board 	Can be mounted in either CPU Unit Option Board slot 1 or 2. Note: 1. Cannot be used for the CP1L-L10. 2. When using CP1W-CIF41 Ver.1.0, one Ethernet port can be added.	CP1W-CIF41	UC1, N, L, CE
LCD Option Board 	Can be mounted only in the CPU Unit Option Board slot 1. Note: Cannot be used for the CP1L-L10.	CP1W-DAM01	UC1, L, N, CE
Memory Cassette 	Can be used for backing up programs or auto-booting.	CP1W-ME05M	UC1, N, L, CE

Ordering Information

■ Programming Devices

Name	Specifications		Model	Standards	
	Number of licenses	Media			
FA Integrated Tool Package CX-One Lite Version 4.□	CX-One Lite is a subset of the complete CX-One package that provides only the Support Software required for micro PLC applications. CX-One Lite runs on the following OS. OS: Windows XP (Service Pack 3 or higher), Vista or 7 Note: Except for Windows XP 64-bit version. CX-One Lite Ver. 4.□ includes Micro PLC Edition CX-Programmer Ver. 9.□.	1 license	CD	CXONE-LT01C-V4	---
FA Integrated Tool Package CX-One Ver. 4.□	CX-One is a package that integrates the Support Software for OMRON PLCs and components. CX-One runs on the following OS. OS: Windows XP (Service Pack 3 or higher), Vista or 7 Note: Except for Windows XP 64-bit version. CX-One Ver. 4.□ includes CX-Programmer Ver. 9.□.	1 license (See note 3.)	DVD (See note 4.)	CXONE-AL01D-V4	---
Programming Device Connecting Cable for CP1W-CIF01 RS-232C Option Board (See note 5.)	Connects DOS computers, D-Sub 9-pin (Length: 2.0 m)	For anti-static connectors	XW2Z-200S-CV	---	
	Connects DOS computers, D-Sub 9-pin (Length: 5.0 m)		XW2Z-500S-CV		
	Connects DOS computers, D-Sub 9-pin (Length: 2.0 m)		XW2Z-200S-V		
	Connects DOS computers, D-Sub 9-pin (Length: 5.0 m)		XW2Z-500S-V		
USB-Serial Conversion Cable (See note 5.)	USB-RS-232C Conversion Cable (Length: 0.5 m) and PC driver (on a CD-ROM disc) are included. Complies with USB Specification 1.1 On personal computer side: USB (A plug connector, male) On PLC side: RS-232C (D-sub 9-pin, male) Driver: Supported by Windows 98, Me, 2000, and XP			CS1W-CIF31	N

- Note: 1.** CP1H PLCs are supported by CX-Programmer version 6.2 or higher.
CP1L PLCs are supported by CX-Programmer version 7.2 or higher, except for 10-point and 60-point CPU Units.
The 10-point and 60-point CPU Units are supported by CX-Programmer version 7.3 or higher.
Update The CX-Programmer version automatically from the website using CX-Programmer version 7.0 (included with CX-One version 2.0).
- 2.** The CX-One and CX-One Lite cannot be simultaneously installed on the same computer.
- 3.** Multi licenses are available for the CX-One (3, 10, 30 or 50 licenses).
- 4.** The CX-One is also available on CD (CXONE-AL□□C-V4).
- 5.** Cannot be used with a peripheral USB port.
To connect to a personal computer via a peripheral USB port, use commercially-available USB cable (A or B type, male).







The following tables lists the Support Software that can be installed from CX-One

Support Software in CX-One		CX-One Lite Ver.4.□	CX-One Ver.4.□	Support Software in CX-One		CX-One Lite Ver.4.□	CX-One Ver.4.□
Micro PLC Edition CX-Programmer	Ver.9.□	Yes	No	CX-Drive	Ver.2.□	Yes	Yes
CX-Programmer	Ver.9.□	No	Yes	CX-Process Tool	Ver.5.□	No	Yes
CX-Integrator	Ver.2.□	Yes	Yes	Faceplate Auto-Builder for NS	Ver.3.□	No	Yes
Switch Box Utility	Ver.1.□	Yes	Yes	CX-Designer	Ver.3.□	Yes	Yes
CX-Protocol	Ver.1.□	No	Yes	NV-Designer	Ver.1.□	Yes	Yes
CX-Simulator	Ver.1.□	Yes	Yes	CX-Thermo	Ver.4.□	Yes	Yes
CX-Position	Ver.2.□	No	Yes	CX-ConfiguratorFDT	Ver.1.□	Yes	Yes
CX-Motion-NCF	Ver.1.□	No	Yes	CX-FLnet	Ver.1.□	No	Yes
CX-Motion-MCH	Ver.2.□	No	Yes	Network Configurator	Ver.3.□	Yes	Yes
CX-Motion	Ver.2.□	No	Yes	CX-Server	Ver.4.□	Yes	Yes

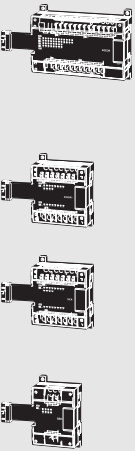
Note: For details, refer to the CX-One Catalog (Cat. No: R134).

Ordering Information

■ Expansion Units

Name	Output method	Inputs	Outputs	Model	Standards
Expansion I/O Units 	Relay	24	16	CP1W-40EDR	N, L, CE
	Transistor (sinking)			CP1W-40EDT	
	Transistor (sourcing)			CP1W-40EDT1	
	Relay	---	32	CP1W-32ER	N, L, CE
	Transistor (sinking)			CP1W-32ET	
	Transistor (sourcing)			CP1W-32ET1	
	Relay	12	8	CP1W-20EDR1	U, C, N, L, CE
	Transistor (sinking)			CP1W-20EDT	
	Transistor (sourcing)			CP1W-20EDT1	
	Relay	---	16	CP1W-16ER	N, L, CE
	Transistor (sinking)			CP1W-16ET	
	Transistor (sourcing)			CP1W-16ET1	
	---	8	---	CP1W-8ED	U, C, N, L, CE
	Relay	---	8	CP1W-8ER	
	Transistor (sinking)		8	CP1W-8ET	
Transistor (sourcing)	8		CP1W-8ET1		
Analog Input Unit 	Analog (resolution: 1/6000)	4	---	CP1W-AD041	UC1, N, L, CE
Analog Output Unit 	Analog (resolution: 1/6000)	---	4	CP1W-DA041	
			2	NEW CP1W-DA021	UC1, CE
Analog I/O Unit 	Analog (resolution: 1/6000)	2	1	CP1W-MAD11	U, C, N, L, CE
CompoBus/S I/O Link Unit 	---	8 (I/O link input bits)	8 (I/O link input bits)	CP1W-SRT21	U, C, N, L, CE
Temperature Sensor Unit 	2 thermocouple inputs		CP1W-TS001		
	4 thermocouple inputs		CP1W-TS002		
	2 platinum resistance thermometer inputs		CP1W-TS101		
	4 platinum resistance thermometer inputs		CP1W-TS102		

CP1L (L Type) CPU Units with 10 points do not support Expansion Units.

■ I/O Connecting Cable

Name	Specifications	Model	Standards
I/O Connecting Cable	80 cm (for CP1W/CPM1A Expansion Units)	CP1W-CN811	UC1, N, L, CE

Note: An I/O Connecting Cable (approx. 6 cm) for horizontal connection is provided with CP1W/CPM1A Expansion Units.

■ Optional Products, Maintenance Products and DIN Track Accessories

Name	Specifications	Model	Standards
Battery Set	For CP1H CPU Units (Use batteries within two years of manufacture.)	CJ1W-BAT01	---
DIN Track	Length: 0.5 m; Height: 7.3 mm	PFP-50N	
	Length: 1 m; Height: 7.3 mm	PFP-100N	
	Length: 1 m; Height: 16 mm	PFP-100N2	
End Plate	There are 2 stoppers provided with CPU Units and I/O Interface Units as standard accessories to secure the Units on the DIN Track.	PFP-M	

Ordering Information

■ CJ-series Special I/O Units and CPU Bus Units

Category	Name	Specifications	Model	Standards
CP1H CPU Unit options	CJ Unit Adapter	Adapter for connecting CJ-series Special I/O Units and CPU Bus Units (includes CJ-series End Cover)	CP1W-EXT01	UC1, N, L, CE
CJ1 Special I/O Units	Analog Input Units	4 inputs (1 to 5 V (1/10,000), 0 to 10 V (1/20,000), -5 to 5 V (1/20,000), -10 to 10 V (1/40,000), and 4 to 20 mA (1/10,000)) Conversion Period: 20 μs/1 point, 25 μs/2 points, 30 μs/3 points, 35 μs/4 points	CJ1W-AD042	UC1, CE
		8 inputs (1 to 5 V, 0 to 5 V, 0 to 10 V, -10 to 10 V, 4 to 20 mA) Resolution: 1/8,000, Conversion speed: 250 μs/input max. (Can be set to 1/4,000 resolution and 1 ms/input.)	CJ1W-AD081-V1	UC1, N, L, CE
		4 inputs (1 to 5 V, 0 to 5 V, 0 to 10 V, -10 to 10 V, 4 to 20 mA) Resolution: 1/8,000, Conversion speed: 250 μs/input max. (Can be set to 1/4,000 resolution and 1 ms/input.)	CJ1W-AD041-V1	
	Analog Output Units	4 outputs (1 to 5 V (1/10,000), 0 to 10 V (1/20,000), and -10 to 10 V (1/40,000)) Conversion Period: 20 μs/1 point, 25 μs/2 points, 30 μs/3 points, 35 μs/4 points	CJ1W-DA042V	UC1, CE
		8 outputs (1 to 5 V, 0 to 5 V, 0 to 10 V, -10 to 10 V) Resolution: 1/4,000; Conversion speed: 1 ms/output max. (Can be set to 1/8000, 250 μs/output.)	CJ1W-DA08V	UC1, N, L, CE
		8 outputs (4 to 20 mA) Resolution: 1/4,000; Conversion speed: 1 ms/output max. (Can be set to 1/8,000, 250 μs/output.)	CJ1W-DA08C	UC1, N, CE
		4 outputs (1 to 5 V, 0 to 5 V, 0 to 10 V, -10 to 10 V, 4 to 20 mA) Resolution: 1/4,000, Conversion speed: 1ms/point max.	CJ1W-DA041	UC1, N, L, CE
		2 outputs (1 to 5 V, 0 to 5 V, 0 to 10 V, -10 to 10 V, 4 to 20 mA) Resolution: 1/4,000, Conversion speed: 1ms/point max.	CJ1W-DA021	
	Analog I/O Unit	4 inputs, 2 outputs (1 to 5 V, 0 to 5 V, 0 to 10 V, -10 to 10 V, 4 to 20 mA) Resolution: 1/4000; Conversion speed: 1 ms/point max. (Can be set to 1/8,000, 500 μs/point.)	CJ1W-MAD42	
	Process Input Units	4 fully universal inputs: Pt100 (3-wire), JPt100 (3-wire), Pt1000 (3-wire), Pt100 (4 wire), K, J, T, E, L, U, N, R, S, B, WRe5-26, PLII, 4 to 20 mA, 0 to 20 mA, 1 to 5 V, 0 to 1.25 V, 0 to 5 V, 0 to 10 V, ±100-mV selectable range, -1.25 to 1.25 V, -5 to 5 V, -10 to 10 V, ±10-V selectable range Potentiometer resolution/conversion speed: 1/256,000 (conversion cycle: 60 ms/4 points), 1/64,000 (conversion cycle: 10 ms/4 points), 1/16,000 (conversion cycle: 5 ms/4 points)	CJ1W-PH41U (See note 1.)	UC1, CE
		4 fully universal inputs: Pt100, JPt100, Pt1000, K, J, T, L, R, S, B, 4 to 20 mA, 0 to 20 mA, 1 to 5 V, 0 to 5 V, 0 to 10 V Conversion speed: 250 ms/4 points	CJ1W-AD04U	UC1, L, CE
		4 inputs, B, J, K, L, R, S, T; Conversion speed: 250 ms/4 inputs	CJ1W-PTS51	UC1, CE
		4 inputs, Pt100 Ω (JIS, IEC), JPt100 Ω, Conversion speed: 250 ms/4 inputs	CJ1W-PTS52	
		2 inputs, B, E, J, K, L, N, R, S, T, U, W, Re5-26, PL ±100 mV, Resolution: 1/64,000; Conversion speed: 10 ms/2 inputs	CJ1W-PTS15	
		2 inputs, Pt100, JPt100, Pt50, Ni508.4; Resolution: 1/64,000; Conversion speed: 10 ms/2 inputs	CJ1W-PTS16	
	Temperature Control Units	2 inputs, 0 to 1.25 V, -1.25 to 1.25 V, 0 to 5 V, 1 to 5 V, -5 to 5 V, 0 to 10 V, -10 to 10 V, ±10-V selectable range, 0 to 20 mA, 4 to 20 mA	CJ1W-PDC15	
		4 loops, thermocouple input, NPN output	CJ1W-TC001	UC1, N, L, CE
		4 loops, thermocouple input, PNP output	CJ1W-TC002	
		2 loops, thermocouple input, NPN output, heater burnout detection function	CJ1W-TC003	
		2 loops, thermocouple input, PNP output, heater burnout detection function	CJ1W-TC004	
		4 loops, platinum resistance thermometer input, NPN output	CJ1W-TC101	
		4 loops, platinum resistance thermometer input, PNP output	CJ1W-TC102	
	2 loops, platinum resistance thermometer input, NPN output, heater burnout detection function	CJ1W-TC103		
	2 loops, platinum resistance thermometer input, PNP output, heater burnout detection function	CJ1W-TC104		
	High-speed Counter Unit	2 inputs, max. input frequency: 500 kpps	CJ1W-CT021	UC1, N, L, CE
	Position Control Units	Pulse train, open collector output, 1 axis	CJ1W-NC113	UC1, CE
		Pulse train, open collector output, 2 axes	CJ1W-NC213	
Pulse train, open collector output, 4 axes		CJ1W-NC413		
Pulse train, line driver output, 1 axis		CJ1W-NC133		
Pulse train, line driver output, 2 axes		CJ1W-NC233		
Pulse train, line driver output, 4 axes		CJ1W-NC433		
Space Unit	---	CJ1W-SP001		
ID Sensor Units	For V680 Series, 1 R/W Head	CJ1W-V680C11	UC, CE	
	For V680 Series, 2 R/W Heads	CJ1W-V680C12		
	For V600 Series, 1 R/W Head	CJ1W-V600C11		
	For V600 Series, 2 R/W Heads	CJ1W-V600C12		
CompoNet Master Unit	Word slaves: 2,048 points, Bit slaves: 512 points	CJ1W-CRM21	U, U1, N, L, CE	
CompoBus/S Master Unit	CompoBus/S remote I/O, 256 points max.	CJ1W-SRM21	UC1, N, L, CE	



Note: 1. If a CJ1W-PH41U is used, do not use a CP1H CPU Unit with relay contact outputs or Expansion Units with relay contact outputs.
2. Refer to the *CJ1 catalog* (Cat. No. P052) for information on the CJ1 Special I/O Units.

Ordering Information

Category	Name	Specifications	Model	Standards	
CJ1 CPU Bus Units	Controller Link Units	Wired (shielded twisted-pair cable)	CJ1W-CLK23	UC1, N, L, CE	
	Serial Communications Units	1 RS-232C port and 1 RS-422A/485 port	CJ1W-SCU42	UC1, N, CE	
		2 RS-232C ports	CJ1W-SCU22		
		2 RS-422A/485 ports	CJ1W-SCU32		
		1 RS-232C port and 1 RS-422A/485 port	CJ1W-SCU41-V1	UC1, N, L, CE	
		2 RS-232C ports	CJ1W-SCU21-V1		
		2 RS-422A/485 ports	CJ1W-SCU31-V1		
	EtherNet/IP Unit	Shielded twisted-pair cable (STP), category 5 or 5e or higher Tag data links and message communications supported	CJ1W-EIP21	UC1, N, L, CE	
	Ethernet Unit	100Base-TX	CJ1W-ETN21		
	DeviceNet Unit	Functions as master and/or slave; allows control of 32,000 points max. per master	CJ1W-DRM21		
	MECHATROLINK-II Position Control Unit	Control commands sent using MECHATROLINK-II synchronized communications 16 axes max., direct operation from ladder diagram, control modes: position/ speed/torque	2 axes	CJ1W-NC271	UC1, CE
			4 axes	CJ1W-NC471	
			16 axes	CJ1W-NCF71	
16 axes			CJ1W-NCF71-MA		
MECHATROLINK-II Motion Control Unit	Position, speed, and torque commands sent via MECHATROLINK-II Special motion control language	32 axes max. (Real axes: 20, Virtual axes: 2)	CJ1W-MCH71		
FI-net Unit	100Base-TX	CJ1W-FLN22	UC1, CE		
SYSMAC SPU	High-speed data collection unit	CJ1W-SPU01-V2			

Note: Refer to the *CJ1 catalog* (Cat. No. P052) for information on the CJ1 CPU Bus Units.

Industrial Switching Hubs

Product name	Appearance	Specifications			Accessories	Current consumption (A)	Model	Standards
		Functions	No. of ports	Failure detection				
Industrial Switching Hubs		Quality of Service (QoS): EtherNet/IP control data priority Failure detection: Broadcast storm and LSI error detection 10/100BASE-TX, Auto-Negotiation	3	No	• Power supply connector	0.22	W4S1-03B	UC, CE
	5		No	0.22		W4S1-05B		
			5	Yes	• Power supply connector • Connector for informing error	0.22	W4S1-05C	CE

OMRON Function Block Library

■ OMRON Function Block Library for Positioning with Position Controllers

When using the CP1H, use the CP1H OMRON Function Block for positioning.

When using the CP1L, use the CP1M-CPU21/22/23 OMRON Function Block for positioning.



FB name (using CP1H)	FB name (using CP1L)	Function name	Description
_NCCP1H011_MoveAbsolute_DINT	_NCCPU011_MoveAbsolute_DINT	Absolute move with DINT	Positions using absolute movement.
_NCCP1H020_MoveRelative_REAL	_NCCPU020_MoveRelative_REAL	Relative move with REAL	Positions using relative movement.
_NCCP1H021_MoveRelative_DINT	_NCCPU021_MoveRelative_DINT	Relative move with DINT	Positions using relative movement.
_NCCP1H030_MoveVelocity_REAL	_NCCPU030_MoveVelocity_REAL	Velocity control with REAL	Controls velocity.
_NCCP1H031_MoveVelocity_DINT	_NCCPU031_MoveVelocity_DINT	Velocity control with DINT	Controls velocity.
_NCCP1H050_Home_REAL	_NCCPU050_Home_REAL	Origin search with REAL	Executes an origin search to establish the origin.
_NCCP1H051_Home_DINT	_NCCPU051_Home_DINT	Origin search with DINT	Executes an origin search to establish the origin.
_NCCP1H061_Stop_REAL	_NCCPU061_Stop_REAL	Deceleration stop with REAL	Decelerates operating axis to a stop.
_NCCP1H062_Stop_DINT	_NCCPU062_Stop_DINT	Deceleration stop with DINT	Decelerates operating axis to a stop.
_NCCP1H110_MoveInterrupt_REAL	_NCCPU110_MoveInterrupt_REAL	Interrupt feeding with REAL	Performs interrupt feeding.
_NCCP1H111_MoveInterrupt_DINT	_NCCPU111_MoveInterrupt_DINT	Interrupt feeding with DINT	Performs interrupt feeding.
_NCCP1H120_MoveSequence	_NCCPU120_MoveSequence	Continuous move	Positions continuously.
_NCCP1H130_MoveTimeAbsolute_REAL	_NCCPU130_MoveTimeAbsolute_REAL	Timed absolute move with REAL	Positions using absolute movement for a specified period of time.
_NCCP1H131_MoveTimeAbsolute_DINT	_NCCPU131_MoveTimeAbsolute_DINT	Timed absolute move with DINT	Positions using absolute movement for a specified period of time.
_NCCP1H140_MoveTimeRelative_REAL	_NCCPU140_MoveTimeRelative_REAL	Timed relative move with REAL	Positions using relative movement for a specified period of time.
_NCCP1H141_MoveTimeRelative_DINT	_NCCPU141_MoveTimeRelative_DINT	Timed relative move with DINT	Positions using relative movement for a specified period of time.
_NCCP1H200_ReadStatus	_NCCPU200_ReadStatus	Read status	Reads the status of the axis.
_NCCP1H204_ReadActualPosition_REAL	_NCCPU204_ReadActualPosition_REAL	Read present position with REAL	Reads the present position of the axis.
_NCCP1H205_ReadActualPosition_DINT	_NCCPU205_ReadActualPosition_DINT	Read present position with DINT	Reads the present position of the axis.
_NCCP1H610_SetPosition_REAL	_NCCPU610_SetPosition_REAL	Shift present position with REAL	Changes the present position.
_NCCP1H611_SetPosition_DINT	_NCCPU611_SetPosition_DINT	Shift present position with DINT	Changes the present position.

OMRON Function Block Library

■ OMRON Function Block Library for E5CN and E5CN-U-series Temperature Controller Serial Communications



FB name	Function name	Description
E5xx003_Stop	Stop	Stops operation for Temperature Controller channel.
E5xN004_ExecuteAT	Execute AT	Starts AT for Temperature Controller channel.
E5xN005_CancelAT	Cancel AT	Cancels AT for Temperature Controller channel.
E5xx200_ReadVariable	Read variable	Reads one item from specified variable area.
E5xx201_ReadStatus	Read status	Reads status of specified Temperature Controller channel.
E5xx202_ReadPV	Read PV	Reads PV of specified Temperature Controller channel.
E5xx203_ReadSP	Read SP	Reads SP of specified Temperature Controller channel.
E5xx204_ReadCoolingMV	Read cooling MV	Reads cooling MV of specified Temperature Controller channel.
E5xx205_ReadHeatingMV	Read heating MV	Reads heating MV of specified Temperature Controller channel.
E5xx400_WriteVariable	Write variable	Writes one data item to specified variable area.
E5xx403_WriteSP	Write SP	Sets SP for specified Temperature Controller channel.
E5xx600_SetComm	Set communications	Sets PLC serial port to default communications settings of Temperature Controller.

Note: These OMRON Function Block can be used for only serial port 2 (the port on the right) for CP1H and CP1L-M30/-M40/-M60 CPU Units. They can be used for serial port 1 only on CP1L-L14/-L20 CPU Units (which have only one serial port). Cannot be used for the CP1L-L10.

■ OMRON Function Block Library for E5AR and E5ER-series Temperature Controller Serial Communications



FB name	Function name	Description
E5xx003_Stop	Stop	Stops operation for Temperature Controller channels.
E5xN004_ExecuteAT	Execute AT	Starts AT for Temperature Controller channels.
E5xN005_CancelAT	Cancel AT	Cancels AT for Temperature Controller channels.
E5xx200_ReadVariable	Read variable	Reads one item in specified variable area.
E5xx201_ReadStatus	Read status	Reads status of specified Temperature Controller channel.
E5xx202_ReadPV	Read PV	Reads PV of specified Temperature Controller channel.
E5xx203_ReadSP	Read SP	Reads SP of specified Temperature Controller channel.
E5xx204_ReadCoolingMV	Read cooling MV	Reads cooling MV of specified Temperature Controller channel.
E5xx205_ReadHeatingMV	Read heating MV	Reads heating MV of specified Temperature Controller channel.
E5xxR206_ReadValveOpening	Read valve opening	Reads valve opening monitor value of specified Temperature Controller channel.
E5xx400_WriteVariable	Write variable	Writes one data item to specified variable area.
E5xx403_WriteSP	Write SP	Sets SP for specified Temperature Controller channel.
E5xx600_SetComm	Set communications	Sets PLC serial port to initial communications settings of Temperature Controller.

Note: These OMRON Function Block can be used for only serial port 2 (the port on the right) for CP1H and CP1L-M30/-M40/-M60 CPU Units. They can be used for serial port 1 only on CP1L-L14/-L20 CPU Units (which have only one serial port). Cannot be used for the CP1L-L10.

■ OMRON Function Block Library for E5ZN-series Temperature Controller Serial Communications



FB name	Function name	Description
E5xx001_ExeOperation	Execute command	Executes specified command.
E5xx002_Run	Run	Starts operation for specified Temperature Controller channel.
E5xx003_Stop	Stop	Stops operation for specified Temperature Controller channel.
E5xN004_ExecuteAT	Execute AT	Starts AT for Temperature Controller channels.
E5xN005_CancelAT	Cancel AT	Cancels AT for Temperature Controller channels.
E5xx200_ReadVariable	Read variable	Reads one item in specified variable area.
E5xx201_ReadStatus	Read status	Reads status of specified Temperature Controller channel.
E5xx202_ReadPV	Read PV	Reads PV of specified Temperature Controller channel.
E5xx203_ReadSP	Read SP	Reads SP of specified Temperature Controller channel.
E5xx204_ReadCoolingMV	Read cooling MV	Reads cooling MV of specified Temperature Controller channel.
E5xx205_ReadHeatingMV	Read heating MV	Reads heating MV of specified Temperature Controller channel.
E5xx400_WriteVariable	Write variable	Writes one data item to specified variable area.
E5xx403_WriteSP	Write SP	Sets SP for specified Temperature Controller channel.
E5xx600_SetComm	Set communications	Sets PLC serial port to default communications settings of Temperature Controller.

Note: These OMRON Function Block can be used for only serial port 2 (the port on the right) for CP1H and CP1L-M30/-M40/-M60 CPU Units. They can be used for serial port 1 only on CP1L-L14/-L20 CPU Units (which have only one serial port). Cannot be used for the CP1L-L10.

SMARTSTEP 2 AC Servo Drivers with Pulse String Inputs

R88M-G/R7D-BP

Advanced Functionality and Performance Packed into a Super-compact Body

- Compact AC Servo Drives

Compared to the SMARTSTEP A Series, the SMARTSTEP 2 Series can reduce the installation space by 48% and the installation size by 39% in terms of volume.

- Suppressing Vibration of Low-rigidity Mechanisms during Acceleration/Deceleration

The damping control function can suppress vibration of low-rigidity mechanisms or devices whose ends tend to vibrate.

- Easy Adjustment

The realtime autotuning function automatically estimates the load inertia of the machine in realtime and sets the optimal gain.

The adaptive filter automatically suppresses vibration caused by resonance.

- Compatible with Command Pulse of 90° Phase Difference Inputs

In addition to conventional CW/CCW inputs (2 pulse inputs) and SIGN/PULS inputs (1 pulse input), the SMARTSTEP 2 supports 90° phase difference inputs. This makes it possible to input encoder output signals directly into the Servo Drive for simplified synchronization control.

- A Wide Range of Pulse Setting Functions

A wide range of pulse setting functions, such as the command pulse multiplying, electronic gear, and encoder dividing, enable you to perform pulse settings suitable for your device or system.

- Simplified Speed Control with Internal Speed Settings

Four internal speed settings allow the speed to be easily switched by using external signals.

- Encoder Dividing Output Function

The number of motor encoder pulses output by the Servo Drive can be freely set in the range of 1 to 2,500 pulses per rotation. A parameter can also be set to change the phase.



Servo Drive-Servomotor Combinations

- Combinations of Cylinder-type 3,000-r/min Servomotors and Servo Drivers

Voltage	Servo Driver	Rated output	Servomotor	
	Pulse-string input		Without brake	With brake
Single-phase 100-V	R7D-BPA5L	50 W	R88M-G05030H	R88M-G05030H-B
	R7D-BP01L	100 W	R88M-G10030L	R88M-G10030L-B
	R7D-BP02L	200 W	R88M-G20030L	R88M-G20030L-B
Single-phase 200-V	R7D-BP01H	50 W	R88M-G05030H	R88M-G05030H-B
		100 W	R88M-G10030H	R88M-G10030H-B
	R7D-BP02HH	200 W	R88M-G20030H	R88M-G20030H-B
Three-phase 200-V	R7D-BP01H	400 W	R88M-G40030H	R88M-G40030H-B
		50 W	R88M-G05030H	R88M-G05030H-B
	R7D-BP02H	200 W	R88M-G20030H	R88M-G20030H-B
R7D-BP04H	400 W	R88M-G40030H	R88M-G40030H-B	

- Combinations of Flat-type 3,000-r/min Servomotors and Servo Drivers

Voltage	Servo Driver	Rated output	Servomotor	
	Pulse-string input		Without brake	With brake
Single-phase 100-V	R7D-BP01L	100 W	R88M-G10030L	R88M-G10030L-B
	R7D-BP02L	200 W	R88M-G20030L	R88M-G20030L-B
Single-phase 200-V	R7D-BP01H	100 W	R88M-G10030H	R88M-G10030H-B
	R7D-BP02HH	200 W	R88M-G20030H	R88M-G20030H-B
	R7D-BP-04H	400 W	R88M-G40030H	R88M-G40030H-B
Three-phase 200-V	R7D-BP01H	100 W	R88M-G10030H	R88M-G10030H-B
	R7D-BP02H	200 W	R88M-G20030H	R88M-G20030H-B
	R7D-BP04H	400 W	R88M-G40030H	R88M-G40030H-B

Note: For information on SMARTSTEP 2, refer to the SMARTSTEP 2 Catalog (Cat. No. I813).

Read and Understand this Catalog

Please read and understand this catalog before purchasing the product. Please consult your OMRON representative if you have any questions or comments.

Warranty and Limitations of Liability

WARRANTY

OMRON's exclusive warranty is that the products are free from defects in materials and workmanship for a period of one year (or other period if specified) from date of sale by OMRON.

OMRON MAKES NO WARRANTY OR REPRESENTATION, EXPRESS OR IMPLIED, REGARDING NON-INFRINGEMENT, MERCHANTABILITY, OR FITNESS FOR PARTICULAR PURPOSE OF THE PRODUCTS. ANY BUYER OR USER ACKNOWLEDGES THAT THE BUYER OR USER ALONE HAS DETERMINED THAT THE PRODUCTS WILL SUITABLY MEET THE REQUIREMENTS OF THEIR INTENDED USE. OMRON DISCLAIMS ALL OTHER WARRANTIES, EXPRESS OR IMPLIED.

LIMITATIONS OF LIABILITY

OMRON SHALL NOT BE RESPONSIBLE FOR SPECIAL, INDIRECT, OR CONSEQUENTIAL DAMAGES, LOSS OF PROFITS OR COMMERCIAL LOSS IN ANY WAY CONNECTED WITH THE PRODUCTS, WHETHER SUCH CLAIM IS BASED ON CONTRACT, WARRANTY, NEGLIGENCE, OR STRICT LIABILITY.

In no event shall the responsibility of OMRON for any act exceed the individual price of the product on which liability is asserted.

IN NO EVENT SHALL OMRON BE RESPONSIBLE FOR WARRANTY, REPAIR, OR OTHER CLAIMS REGARDING THE PRODUCTS UNLESS OMRON'S ANALYSIS CONFIRMS THAT THE PRODUCTS WERE PROPERLY HANDLED, STORED, INSTALLED, AND MAINTAINED AND NOT SUBJECT TO CONTAMINATION, ABUSE, MISUSE, OR INAPPROPRIATE MODIFICATION OR REPAIR.

Application Considerations

SUITABILITY FOR USE

OMRON shall not be responsible for conformity with any standards, codes, or regulations that apply to the combination of the product in the customer's application or use of the product.

Take all necessary steps to determine the suitability of the product for the systems, machines, and equipment with which it will be used.

Know and observe all prohibitions of use applicable to this product.

NEVER USE THE PRODUCT FOR AN APPLICATION INVOLVING SERIOUS RISK TO LIFE OR PROPERTY WITHOUT ENSURING THAT THE SYSTEM AS A WHOLE HAS BEEN DESIGNED TO ADDRESS THE RISKS, AND THAT THE OMRON PRODUCT IS PROPERLY RATED AND INSTALLED FOR THE INTENDED USE WITHIN THE OVERALL EQUIPMENT OR SYSTEM.

PROGRAMMABLE PRODUCTS

OMRON shall not be responsible for the user's programming of a programmable product, or any consequence thereof.

Disclaimers

CHANGE IN SPECIFICATIONS

Product specifications and accessories may be changed at any time based on improvements and other reasons. Consult with your OMRON representative at any time to confirm actual specifications of purchased product.

DIMENSIONS AND WEIGHTS

Dimensions and weights are nominal and are not to be used for manufacturing purposes, even when tolerances are shown.

PERFORMANCE DATA

Performance data given in this catalog is provided as a guide for the user in determining suitability and does not constitute a warranty. It may represent the result of OMRON's test conditions, and the users must correlate it to actual application requirements. Actual performance is subject to the OMRON Warranty and Limitations of Liability.

Note: Do not use this document to operate the Unit.

OMRON Corporation Industrial Automation Company
Tokyo, JAPAN

Contact: www.ia.omron.com

Regional Headquarters

OMRON EUROPE B.V.

Wegalaan 67-69-2132 JD Hoofddorp
The Netherlands
Tel: (31) 2356-81-300/Fax: (31) 2356-81-388

OMRON ELECTRONICS LLC

One Commerce Drive Schaumburg,
IL 60173-5302 U.S.A.
Tel: (1) 847-843-7900/Fax: (1) 847-843-7787

OMRON ASIA PACIFIC PTE. LTD.

No. 438A Alexandra Road # 05-05/08 (Lobby 2),
Alexandra Technopark,
Singapore 119967
Tel: (65) 6835-3011/Fax: (65) 6835-2711

OMRON (CHINA) CO., LTD.

Room 2211, Bank of China Tower,
200 Yin Cheng Zhong Road,
PuDong New Area, Shanghai, 200120, China
Tel: (86) 21-5037-2222/Fax: (86) 21-5037-2200

Authorized Distributor:

© OMRON Corporation 2009 All Rights Reserved.
In the interest of product improvement,
specifications are subject to change without notice.

CSM_6_1_0711
Cat. No. P057-E1-08

Printed in Japan
0910 (0507)

Mouser Electronics

Authorized Distributor

Click to View Pricing, Inventory, Delivery & Lifecycle Information:

Omron:

[CP1LL20DRA](#) [CP1LM40DRA](#) [CP1HXA40DTD](#) [CP1LL14DRA](#) [CP1L-L14DR-A](#) [CP1L-L20DR-A](#) [CP1L-M40DR-A](#)
[CP1L-M30DR-A](#)

Компания «Океан Электроники» предлагает заключение долгосрочных отношений при поставках импортных электронных компонентов на взаимовыгодных условиях!

Наши преимущества:

- Поставка оригинальных импортных электронных компонентов напрямую с производств Америки, Европы и Азии, а так же с крупнейших складов мира;
- Широкая линейка поставок активных и пассивных импортных электронных компонентов (более 30 млн. наименований);
- Поставка сложных, дефицитных, либо снятых с производства позиций;
- Оперативные сроки поставки под заказ (от 5 рабочих дней);
- Экспресс доставка в любую точку России;
- Помощь Конструкторского Отдела и консультации квалифицированных инженеров;
- Техническая поддержка проекта, помощь в подборе аналогов, поставка прототипов;
- Поставка электронных компонентов под контролем ВП;
- Система менеджмента качества сертифицирована по Международному стандарту ISO 9001;
- При необходимости вся продукция военного и аэрокосмического назначения проходит испытания и сертификацию в лаборатории (по согласованию с заказчиком);
- Поставка специализированных компонентов военного и аэрокосмического уровня качества (Xilinx, Altera, Analog Devices, Intersil, Interpoint, Microsemi, Actel, Aeroflex, Peregrine, VPT, Syfer, Eurofarad, Texas Instruments, MS Kennedy, Miteq, Cobham, E2V, MA-COM, Hittite, Mini-Circuits, General Dynamics и др.);

Компания «Океан Электроники» является официальным дистрибьютором и эксклюзивным представителем в России одного из крупнейших производителей разъемов военного и аэрокосмического назначения «**JONHON**», а так же официальным дистрибьютором и эксклюзивным представителем в России производителя высокотехнологичных и надежных решений для передачи СВЧ сигналов «**FORSTAR**».



JONHON

«**JONHON**» (основан в 1970 г.)

Разъемы специального, военного и аэрокосмического назначения:

(Применяются в военной, авиационной, аэрокосмической, морской, железнодорожной, горно- и нефтедобывающей отраслях промышленности)

«**FORSTAR**» (основан в 1998 г.)

ВЧ соединители, коаксиальные кабели, кабельные сборки и микроволновые компоненты:

(Применяются в телекоммуникациях гражданского и специального назначения, в средствах связи, РЛС, а так же военной, авиационной и аэрокосмической отраслях промышленности).



Телефон: 8 (812) 309-75-97 (многоканальный)

Факс: 8 (812) 320-03-32

Электронная почта: ocean@oceanchips.ru

Web: <http://oceanchips.ru/>

Адрес: 198099, г. Санкт-Петербург, ул. Калинина, д. 2, корп. 4, лит. А