

DATA SHEET

Part No.	AN44070A
Package Code No.	HSOP034-P-0300A

Contents

■ Overview	3
■ Features	3
■ Applications	3
■ Package	3
■ Type	3
■ Application Circuit Example	4
■ Pin Descriptions	5
■ Absolute Maximum Ratings	6
■ Operating Supply Voltage Range	6
■ Allowed Voltage and Current Ranges	7
■ Electrical Characteristics	8
■ Electrical Characteristics (Reference values for design)	10
■ Technical Data	11
• Circuit diagrams of the input/output part and pin function descriptions	11
• Control mode (truth table)	15
• P_D — T_a diagram	16
■ Usage Notes	17

AN44070A

Driver IC for DC Motor

■ Overview

AN44070A is a two channels H-bridge driver IC. 2-ch. DC motor can be controlled by a single driver IC.

■ Features

- Built-in thermal protection and low voltage detection circuit
- Built-in Over Current Protection (when external resistance is added to Pin8 and Pin10.)
- Built-in 5 V power supply

■ Applications

- IC for DC motor drives

■ Package

- 34 pin Plastic Small Outline Package with Back Heat Sink (SOP Type)

■ Type

- Bi-CDMOS IC

■ Application Circuit Example

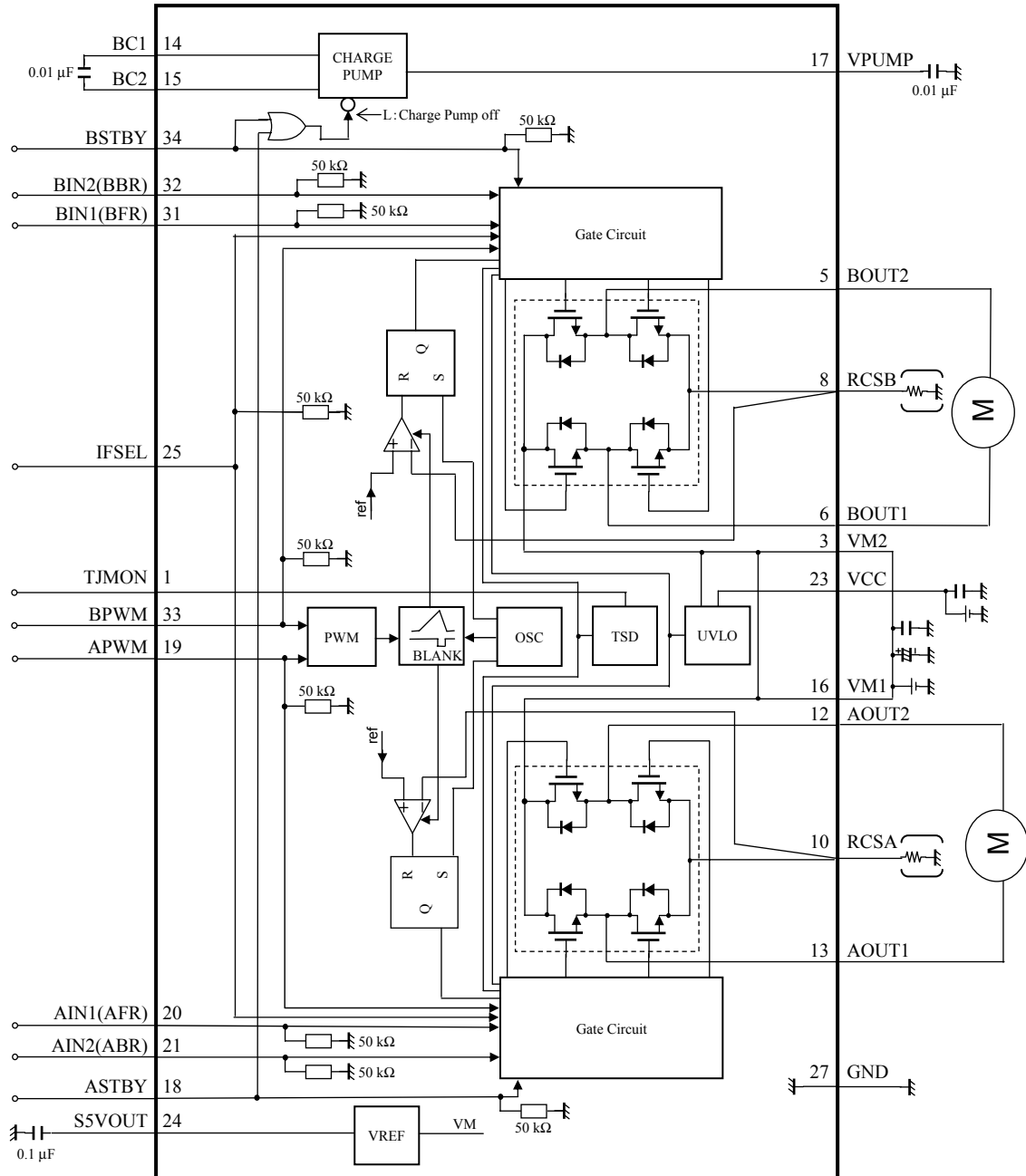

■ Pin Descriptions

Pin No.	Pin name	Type	Description
1	TJMON	Output	VBE monitor use
2	N.C.	—	—
3	VM2	Power supply	Motor power supply 2
4	N.C.	—	—
5	BOUT2	Output	Ch. B motor drive output 2
6	BOUT1	Output	Ch. B motor drive output 1
7	N.C.	—	—
8	RCSB	Input / Output	Ch. B current detection
9	GND	Ground	Die pad ground
10	RCSA	Input / Output	Ch. A current detection
11	N.C.	—	—
12	AOUT2	Output	Ch. A motor drive output 2
13	AOUT1	Output	Ch. A motor drive output 1
14	BC1	Output	Charge Pump capacitor connection 1
15	BC2	Output	Charge Pump capacitor connection 2
16	VM1	Power supply	Motor power supply 1
17	VPUMP	Output	Charge Pump circuit output
18	ASTBY	Input	Ch. A Standby input
19	APWM	Input	Ch. A PWM input
20	AIN1	Input	Ch. A Forward – Reverse input1 (IFSEL = Low or OPEN)
21	AIN2	Input	Ch. A Forward – Reverse input2 (IFSEL = Low or OPEN) / Ch. A Brake Mode input (IFSEL = High)
22	N.C.	—	—
23	VCC	Power supply	Signal power supply
24	S5VOUT	Output	Internal reference voltage (5 V output)
25	IFSEL	Input	Input Mode select
26	GND	Ground	Die pad ground
27	GND	Ground	Signal ground
28	N.C.	—	—
29	N.C.	—	—
30	N.C.	—	—
31	BIN1	Input	Ch. B Forward – Reverse input1 (IFSEL = Low or OPEN)
32	BIN2	Input	Ch. B Forward – Reverse input2 (IFSEL = Low or OPEN) / Ch. B Brake Mode input (IFSEL = High)
33	BPWM	Input	Ch. B PWM input
34	BSTBY	Input	Ch. B Standby input

■ Absolute Maximum Ratings

A No.	Parameter	Symbol	Rating	Unit	Note
1	Supply voltage1 (Pin3, Pin16)	V_M	37	V	*1
2	Supply voltage2 (Pin23)	V_{CC}	- 0.3 to +6	V	*1
3	Power dissipation	P_D	0.466	W	*2
4	Operating ambient temperature	T_{stg}	-20 to +70	°C	*3
5	Storage temperature	T_{opr}	-55 to +150	°C	*3
6	Output pin voltage (Pin5, 6, 12, 13)	V_{OUT}	37	V	*4
7	Motor drive current (Pin5, 6, 12, 13)	I_{OUT}	± 2.5	A	*4, *5
8	Flywheel diode current (Pin5, 6, 12, 13)	I_n	2.5	A	*4, *5

Notes) *1 : The values under the condition not exceeding the above absolute maximum ratings and the power dissipation.

*2 : The power dissipation shown is the value at $T_a = 70^\circ\text{C}$ for the independent (unmounted) IC package without a heat sink.

When using this IC, refer to the P_D - T_a diagram in the ■ Technical Data standard and use under the condition not exceeding the allowable value.

*3 : Except for the power dissipation, operating ambient temperature, and storage temperature, all ratings are for $T_a = 25^\circ\text{C}$.

*4 : Do not apply current or voltage from outside to any pin not listed above.

In the circuit current, (+) means the current flowing into IC and (-) means the current flowing out of IC.

*5 : Four-layer PCB with 1 500 mm² of copper ground area on second-layer and third-layer connected with thermal vias and to device exposed pad.

If exposed thermal pad is not connected copper ground area, current rating is 1.5 A.

■ Operating Supply Voltage Range

Parameter	Symbol	Range	Unit	Note
Operating supply voltage range1	V_M	10.0 to 34.0	V	*
Operating supply voltage range2	V_{CC}	3.0 to 5.5	V	*

Note) * : The values under the condition not exceeding the above absolute maximum ratings and the power dissipation.

■ Allowed Voltage and Current Ranges

Notes) • Rating Voltage is voltage of pin on GND

- Do not apply current or voltage from outside to any pin not listed above.

Pin No.	Pin name	Rating	Unit	Note
8	RCSB	+ 2.5	V	—
10	RCSA	+ 2.5	V	—
14	BC1	$V_M + 0.3$	V	—
15	BC2	$(V_M - 1)$ to 43	V	—
17	VPUMP	$(V_M - 2)$ to 43	V	—
18	ASTBY	- 0.3 to 6	V	—
19	APWM	- 0.3 to 6	V	—
20	AIN1	- 0.3 to 6	V	—
21	AIN2	- 0.3 to 6	V	—
24	S5VOUT	-7 to 0	mA	—
25	IFSEL	- 0.3 to 6	V	—
31	BIN1	- 0.3 to 6	V	—
32	BIN2	- 0.3 to 6	V	—
33	BPWM	- 0.3 to 6	V	—
34	BSTBY	- 0.3 to 6	V	—

■ Electrical Characteristics at $V_M = 24\text{ V}$, $V_{CC} = 5\text{ V}$

Note) $T_a = 25^\circ\text{C} \pm 2^\circ\text{C}$ unless otherwise specified.

B No.	Parameter	Symbol	Conditions	Limits			Unit	Note
				Min	Typ	Max		
Output Drivers								
1	High-level output saturation voltage	V_{OH}	$I = -1.2\text{ A}$	V_M -0.63	V_M -0.42	—	V	—
2	Low-level output saturation voltage	V_{OL}	$I = 1.2\text{ A}$	—	0.55	0.825	V	—
3	Flywheel diode forward voltage	V_{DI}	$I = 1.2\text{ A}$	0.5	1.0	1.5	V	—
4	Output leakage current 1	I_{LEAK1}	$V_M = V_{OUT} = 37\text{ V}$, $V_{RCS} = 0\text{ V}$	—	10	50	μA	—
Power Supply								
5	Supply current1 (with two circuits turned off)	I_{M1}	$ASTBY = BSTBY = 0\text{ V}$	—	3	4.5	mA	—
6	Supply current2 (with two circuits turned on)	I_{M2}	$ASTBY = BSTBY = 5\text{ V}$	—	5.3	7.9	mA	—
7	Supply current3 (with two circuits turned on)	I_{CC}	$ASTBY = BSTBY = 5\text{ V}$	—	1.4	2.2	mA	—
8	Reference voltage	V_{SSVOUT}	$I_{SSVOUT} = -2.5\text{ mA}$	4.5	5.0	5.5	V	—
9	Output impedance	Z_{SSVOUT}	$I_{SSVOUT} = -5\text{ mA}$	—	18	27	Ω	—
IN input								
10	High-level IN input voltage	V_{INH}	—	2.2	—	V_{CC}	V	—
11	Low-level IN input voltage	V_{INL}	—	0	—	0.6	V	—
12	High-level IN input current	I_{INH}	$A_{IN1} = A_{IN2} = B_{IN1} = B_{IN2} = 5\text{ V}$	70	—	130	μA	—
13	Low-level IN input current	I_{INL}	$A_{IN1} = A_{IN2} = B_{IN1} = B_{IN2} = 0\text{ V}$	-10	—	10	μA	—
Standby input								
14	High-level STBY input voltage	V_{STBYH}	—	2.2	—	V_{CC}	V	—
15	Low-level STBY input voltage	V_{STBYL}	—	0	—	0.6	V	—
16	High-level STBY input current	I_{STBYH}	$ASTBY = BSTBY = 5\text{ V}$	70	—	130	μA	—
17	Low-level STBY input current	I_{STBYL}	$ASTBY = BSTBY = 0\text{ V}$	-10	—	10	μA	—
IFSEL input								
18	High-level IFSEL input voltage	V_{IFSELH}	—	2.2	—	V_{CC}	V	—
19	Low-level IFSEL input voltage	V_{IFSELL}	—	0	—	0.6	V	—
20	High-level IFSEL input current	I_{IFSELH}	IFSEL = 5 V	70	—	130	μA	—
21	Low-level IFSEL input current	I_{IFSELL}	IFSEL = 0 V	-10	—	10	μA	—

■ Electrical Characteristics (continued) at $V_M = 24\text{ V}$, $V_{CC} = 5\text{ V}$

Note) $T_a = 25^\circ\text{C} \pm 2^\circ\text{C}$ unless otherwise specified.

B No.	Parameter	Symbol	Conditions	Limits			Unit	Note
				Min	Typ	Max		
PWM input								
22	High-level PWM input voltage	V_{PWHH}	—	2.2	—	V_{CC}	V	—
23	Low-level PWM input voltage	V_{PWL}	—	0	—	0.6	V	—
24	High-level PWM input current	I_{PWHH}	APWM = BPWM = 5 V	70	—	130	μA	—
25	Low-level PWM input current	I_{PWL}	APWM = BPWM = 0 V	-10	—	10	μA	—
26	PWM Input Max frequency	f_{PWM}	—	—	—	100	kHz	—
27	Input Min pulse width	t_w	—	5	—	—	μs	—

■ Electrical Characteristics (Reference values for design) at $V_M = 24\text{ V}$, $V_{CC} = 5\text{ V}$

Notes) $T_a = 25^\circ\text{C} \pm 2^\circ\text{C}$ unless otherwise specified.

The characteristics listed below are reference values derived from the design of the IC and are not guaranteed by inspection.

If a problem does occur related to these characteristics, we will respond in good faith to user concerns.

B No.	Parameter	Symbol	Conditions	Reference			Unit	Note
				Min	Typ	Max		
Output Drivers								
28	Output slew rate 1	V_{T_r}	Rising edge	—	150	—	V/ μs	—
29	Output slew rate 2	V_{T_f}	Falling edge	—	190	—	V/ μs	—
30	Dead time	T_D	—	—	1.1	—	μs	—
Thermal Protection								
31	Thermal protection operating temperature	$T_{SD_{on}}$	—	—	150	—	$^\circ\text{C}$	—
32	Thermal protection hysteresis width	ΔT_{SD}	—	—	40	—	$^\circ\text{C}$	—

■ Technical Data

- Circuit diagrams of the input/output part and pin function descriptions

Note) The characteristics listed below are reference values based on the IC design and are not guaranteed.

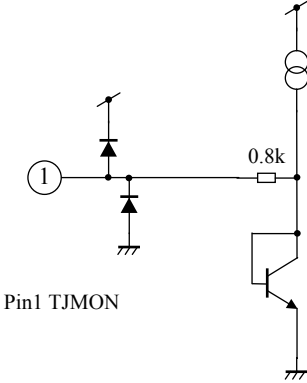
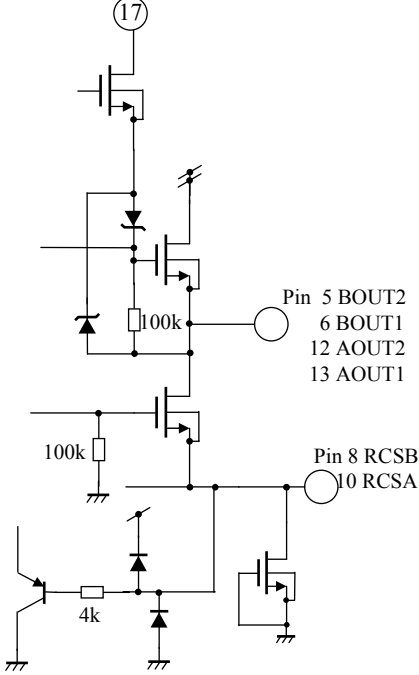
Pin No.	Waveform and voltage	Inner circuit	Impedance	Description
1	—	 <p>Pin1 TJMON</p>	—	Pin1 : VBE monitor use
5 6 8 10 12 13	—	 <p>Pin 5 BOUT2 6 BOUT1 12 AOUT2 13 AOUT1</p> <p>Pin 8 RCSB 10 RCSA</p>	—	Pin 5 : Ch. B motor drive output 2 6 : Ch. B motor drive output 1 8 : Ch. B current detection 12 : Ch. A motor drive output 2 13 : Ch. A motor drive output 1 10 : Ch. A current detection

■ Technical Data (continued)

- Circuit diagrams of the input/output part and pin function descriptions (continued)

Note) The characteristics listed below are reference values based on the IC design and are not guaranteed.

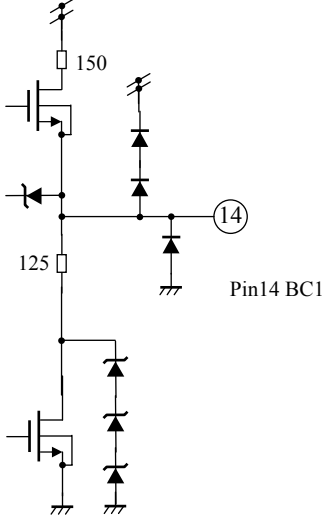
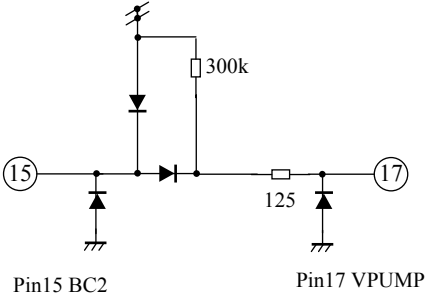
Pin No.	Waveform and voltage	Inner circuit	Impedance	Description
14	—		—	Pin14 : Charge Pump capacitor connection 1
15 17	—		—	Pin15 : Charge Pump capacitor connection 2 17 : Charge Pump circuit output

■ Technical Data (continued)

- Circuit diagrams of the input/output part and pin function descriptions (continued)



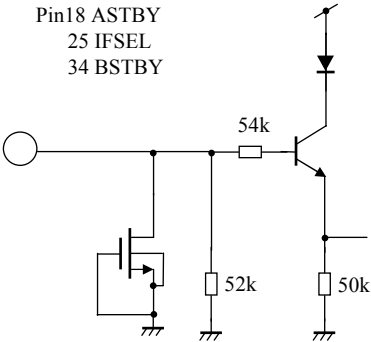
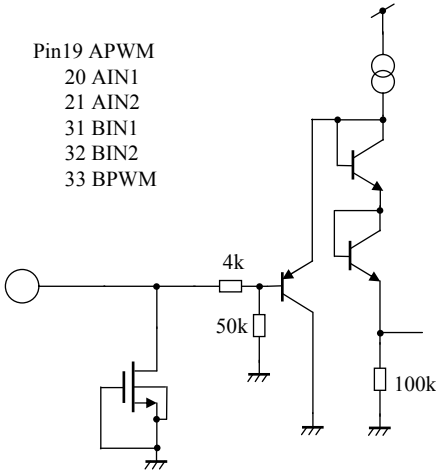



Note) The characteristics listed below are reference values based on the IC design and are not guaranteed.

Pin No.	Waveform and voltage	Inner circuit	Impedance	Description
18 25 34	—	<p>Pin18 ASTBY 25 IFSEL 34 BSTBY</p> 	52 kΩ	<p>Pin 18 : Ch. A Standby / Active CTL 25 : Input mode selection input 34 : Ch. B Standby / Active CTL</p>
19 20 21 31 32 33	—	<p>Pin19 APWM 20 AIN1 21 AIN2 31 BIN1 32 BIN2 33 BPWM</p> 	54 kΩ	<p>Pin19 : Ch. A PWM input 20 : Ch. A Forward / Reverse input 1 21 : Ch. A Forward / Reverse input 2 31 : Ch. B Forward / Reverse input 1 32 : Ch. B Forward / Reverse input 2 33 : Ch. B PWM input</p>

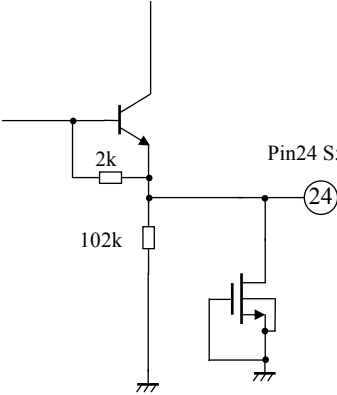
■ Technical Data (continued)

- Circuit diagrams of the input/output part and pin function descriptions (continued)

Note) The characteristics listed below are reference values based on the IC design and are not guaranteed.

Pin No.	Waveform and voltage	Inner circuit	Impedance	Description
24	—		—	Pin24 : Internal reference voltage (5 V output)
Sym bols	—	<p>  VCC (Pin23)  VM (Pin3, Pin16)  Diode  Zener diode  Ground </p>	—	—

■ Technical Data (continued)

- Control mode (truth table)

INPUT					OUTPUT		
IFSEL	STBY	IN1	IN2	PWM	AOUT1 /BOUT1	AOUT2 /BOUT2	Mode
"L"	"H"	"H"	"H"	—	"H"	"H"	Short Brake
		"L"	"H"	"H"	"L"	"H"	Forward
				"L"	"H"	"H"	Short Brake
		"H"	"L"	"H"	"H"	"L"	Reverse
				"L"	"H"	"H"	Short Brake
	"L"	"L"	—	OFF	OFF	Stop	
	"L"	—	—	—	OFF	OFF	Standby

INPUT					OUTPUT		
IFSEL	STBY	IN1	IN2	PWM	AOUT1 /BOUT1	AOUT2 /BOUT2	Mode
"H"	"H"	—	"H"	"L"	"H"	"H"	Short Brake
		"L"	—	"H"	"L"	"H"	Forward
		"H"	—	"H"	"H"	"L"	Reverse
		—	"L"	"L"	OFF	OFF	Stop
	"L"	—	—	—	OFF	OFF	Standby

INPUT		OUTPUT
ASTBY	BSTBY	Charge Pump
"H"	"H"	ON
"H"	"L"	
"L"	"H"	
"L"	"L"	OFF *1

Note) *1 : Before the motor begins to rotate, install the wait time of 200μs after releasing Standby.

■ Technical Data (continued)

- $P_D - T_a$ diagram

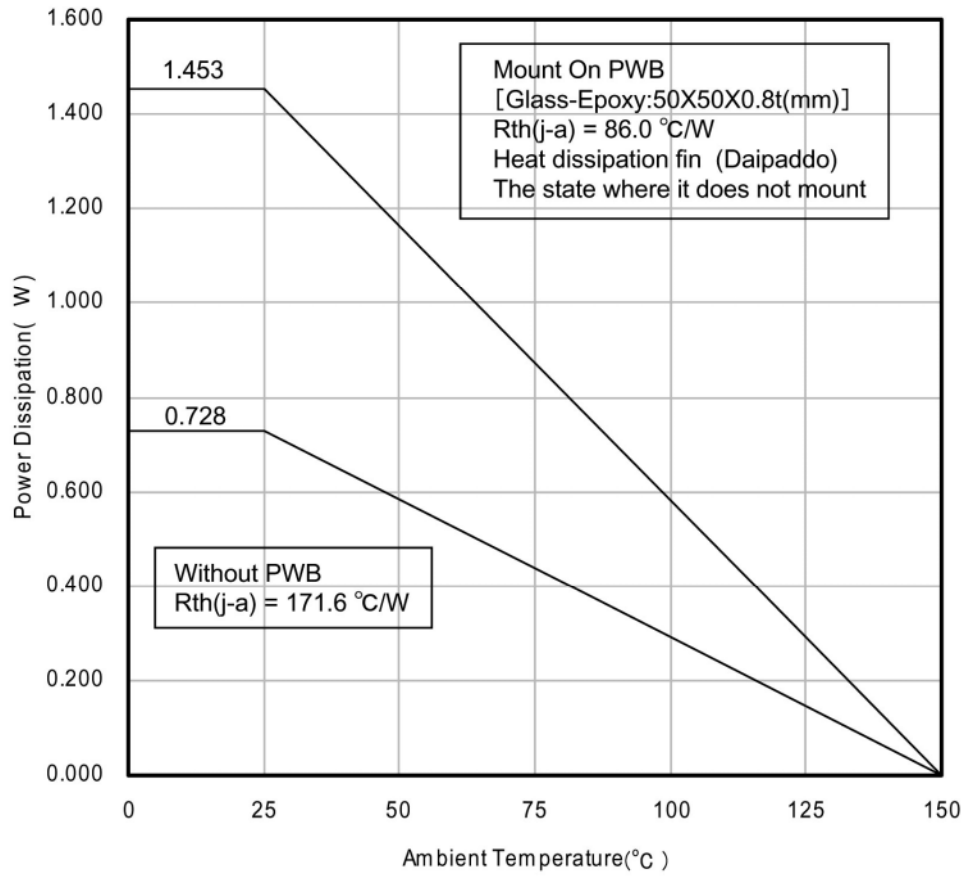

■ Usage Notes

1. Perform thermal design work with consideration of a sufficient margin to keep the power dissipation based on supply voltage, load, and ambient temperature conditions.
(The IC is recommended that junctions are designed below 70 ~ 80% of Absolute Maximum Rating.)
2. The protection circuit is incorporated for the purpose of securing safety if the IC malfunctions.
Therefore, design the protection circuit so that the protection circuit will not operate under normal operating conditions. The temperature protection circuit, in particular, may be destructed before the temperature protection circuit operates if the area of safety operation of the device or the maximum rating is exceeded instantaneously due to the short-circuiting between the output pin and VM pin or a ground fault caused by the output pin and ground pin.
3. Pay utmost attention to the pattern layout in order to prevent the IC from destruction resulting from the short-circuiting of pins.
See page 6 *Pin Descriptions* for allocations of the pins of the IC.
4. When driving a motor coil or transformer (L) load, the device may be destructed as a result of a negative or excessive voltage generated at the time of turning the load on and off. Unless otherwise provided in the specifications, do not apply any negative or excessive voltage.
5. Do not make mistakes in the PCB mounting direction. If power is supplied with the pins mounted in the wrong direction, the IC may be destructed.
6. The IC may be destructed by the solder bridge between the pins of semiconductor devices. Fully make a visual check on the PCB before supplying power.
Furthermore, the IC may be destructed if conductive foreign matters like solder chips are stuck to the IC during transportation after PCB mounting. Therefore, conduct full technical verification of the mounting quality of the IC.
7. The IC is destructed under an abnormal condition, such as the short-circuiting between the output and VM pins, output and ground pins, or output pins (i.e., load short-circuiting), in which case smoke may be generated. Pay utmost attention to the use of the IC.

Pay special attention to the following pins so that they are not short-circuited with the VM pin, ground pin, other output pin, or current detection pin.

- (1) AOUT1 (Pin13), AOUT2 (Pin12), BOUT1 (Pin6), BOUT2 (Pin5)
- (2) BC2 (Pin15), VPUMP (Pin17)
- (3) VM1 (Pin16), VM2 (Pin3), VCC(Pin23), S5VOUT(Pin24)
- (4) RCSA (Pin10), RCSB (Pin8)

The higher the current capacity of power supply is, the higher the possibility of the above destruction or smoke generation. Therefore, it is recommended to take safety countermeasures, such as the use of a fuse.

8. When using the IC for model expansion or new sets, be sure to make full safety checks including a long-term reliability check on each set.
9. Set the value of the capacitor between the VPUMP and GND pins so that the voltage on the VPUMP pin (Pin17) will not exceed 43 V in any case regardless of whether it is a transient phenomenon or not while the motor standing by is started.
10. This IC employs a PWM drive method that switches the high-current output of the output transistor. Therefore, the IC is apt to generate noise that may cause the IC to malfunction or have fatal damage. To prevent these problems, the power supply must be stable enough. Therefore, the capacitance between the S5VOUT and GND pins must be a minimum of 0.1 μF and the one between the VM and GND pins must be a minimum of 47 μF and as close as possible to the IC so that PWM noise will not cause the IC to malfunction or have fatal damage.

■ Usage Notes (continued)

11. A high current flows into the IC. Therefore, the common impedance of the PCB pattern cannot be ignored. Take the following points into consideration and design the PCB pattern of the motor.

A high current flows into the line between the VM1 (Pin16) and VM2 (Pin3) pins. Therefore, noise is generated with ease at the time of switching due to the inductance (L) of the line, which may result in the malfunctioning or destruction of the IC (see the circuit diagram on the left-hand side). As shown in the circuit diagram on the right-hand side, the escape way of the noise is secured by connecting a capacitor to the connector close to the VM pin of the IC. This makes it possible to suppress the direct VM pin voltage of the IC. Make the settings as shown in the circuit diagram on the right-hand side as much as possible.

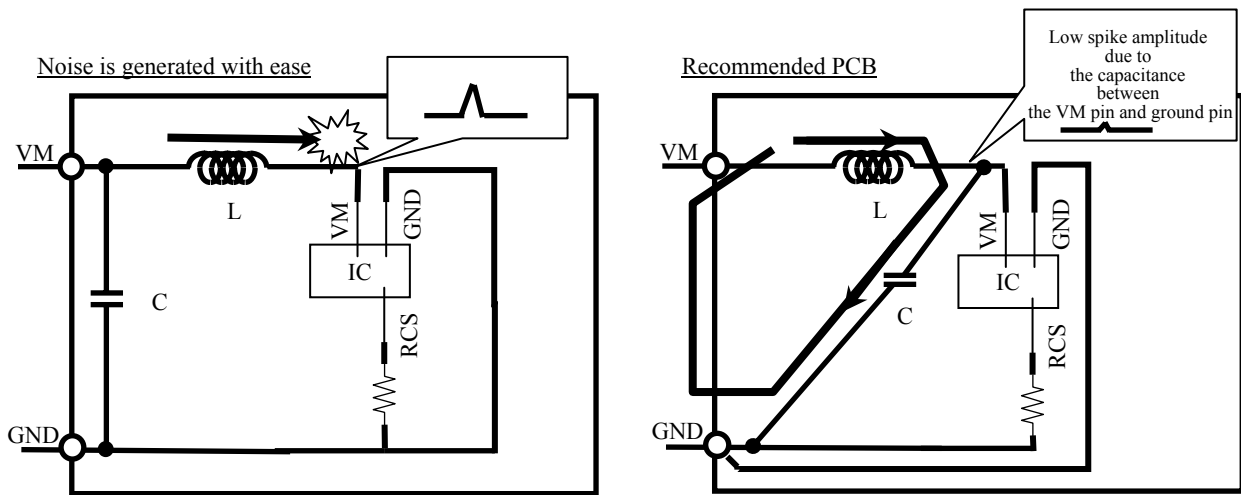

12. In the case of measuring the chip temperature of the IC, measure the voltage of TJMON(Pin1) and presume chip temperature from following data. Use the following data as reference data. Before applying the IC to a product, conduct a sufficient reliability test of the IC along with the evaluation of the product with the IC incorporated.

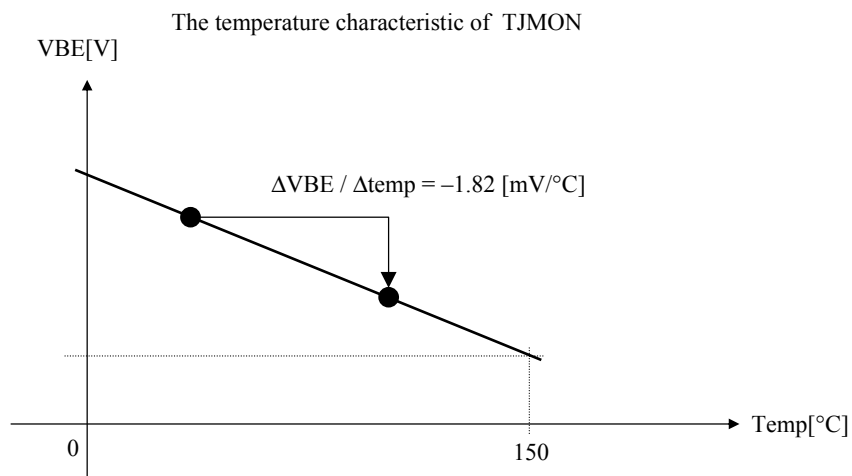

■ Usage Notes (continued)

13. Power Supply Sequence

- If two types of power supply are used
 Rise : This IC is recommended rise of 5 V power supply before rise of 24 V power supply.
 Fall : Although there is no particular rule, check that VM fall-time is about 1 s.

When recommended sequence is difficult, take the diagram below indicates into consideration and design.

Also, rise slew rate design

VM : below $0.1\text{V}/\mu\text{s}$, VCC : below $0.1\text{V}/\mu\text{s}$

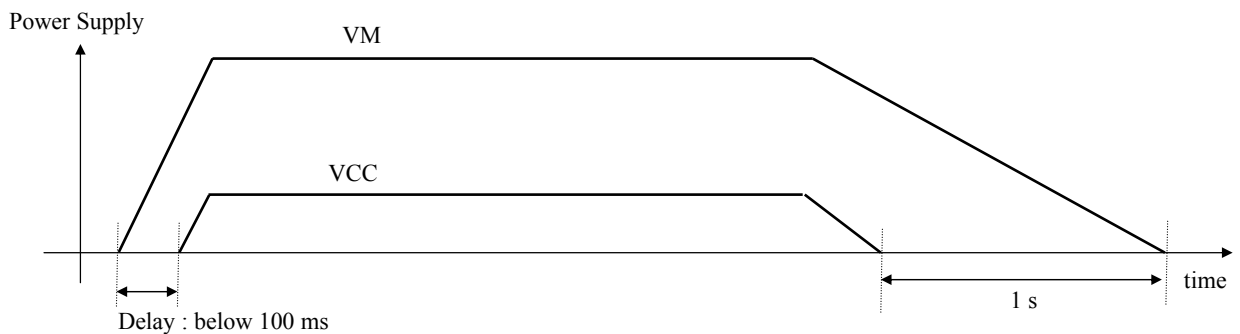

- If one type of power supply is used
 Rise/Fall slew rate design, VM : below $0.1\text{V}/\mu\text{s}$
 Please check that it is less than 1.0 sec between VCC falling down to 0 volt and VM falling down to 0 volt.

14. Charge pump circuit

- The charge pump circuit has stopped when the Low signal is input to ASTBY(Pin18) and BSTBY(Pin34).
 The start time is necessary until the charge pump circuit begins operating. Please take the weight time of $200\ \mu\text{s}$ until the motor starts rotating after making IC active.

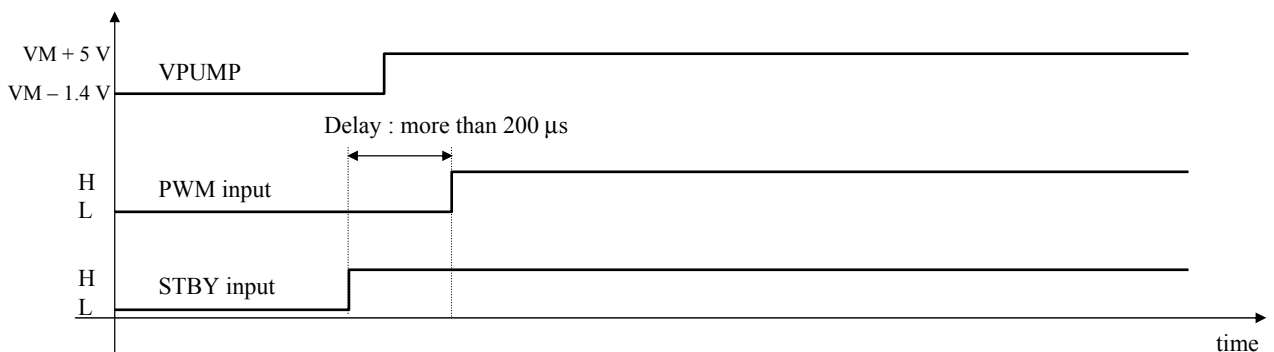

15. PWM operation

- The PWM operation of this IC assumes the control by the input switching of APWM (Pin19) or BPWM (Pin33).
 When AN44070A is operated PWM by using other terminals, the duty of the output is extremely different from the duty of the input. Please use APWM or BPWM when AN44070A is operated PWM.
- When Free Run Mode and Forward/Reverse Mode is repeated in PWM operation, the backflow current flows from GND toward VM. Please add external capacity so as not to exceed the absolute maximum rating of VM.

16. IFSEL terminal

- Do not switch the terminal IFSEL(Pin25) while IC is active Mode.
 Please switch IFSEL after the power supply is turned off once or the Low signal is input to ASTBY and BSTBY.

17. Check the risk that is caused by the failure of external components.

Request for your special attention and precautions in using the technical information and semiconductors described in this book

- (1) If any of the products or technical information described in this book is to be exported or provided to non-residents, the laws and regulations of the exporting country, especially, those with regard to security export control, must be observed.
- (2) The technical information described in this book is intended only to show the main characteristics and application circuit examples of the products. No license is granted in and to any intellectual property right or other right owned by Panasonic Corporation or any other company. Therefore, no responsibility is assumed by our company as to the infringement upon any such right owned by any other company which may arise as a result of the use of technical information described in this book.
- (3) The products described in this book are intended to be used for general applications (such as office equipment, communications equipment, measuring instruments and household appliances), or for specific applications as expressly stated in this book.
Consult our sales staff in advance for information on the following applications:
 - Special applications (such as for airplanes, aerospace, automotive equipment, traffic signaling equipment, combustion equipment, life support systems and safety devices) in which exceptional quality and reliability are required, or if the failure or malfunction of the products may directly jeopardize life or harm the human body.It is to be understood that our company shall not be held responsible for any damage incurred as a result of or in connection with your using the products described in this book for any special application, unless our company agrees to your using the products in this book for any special application.
- (4) The products and product specifications described in this book are subject to change without notice for modification and/or improvement. At the final stage of your design, purchasing, or use of the products, therefore, ask for the most up-to-date Product Standards in advance to make sure that the latest specifications satisfy your requirements.
- (5) When designing your equipment, comply with the range of absolute maximum rating and the guaranteed operating conditions (operating power supply voltage and operating environment etc.). Especially, please be careful not to exceed the range of absolute maximum rating on the transient state, such as power-on, power-off and mode-switching. Otherwise, we will not be liable for any defect which may arise later in your equipment.
Even when the products are used within the guaranteed values, take into the consideration of incidence of break down and failure mode, possible to occur to semiconductor products. Measures on the systems such as redundant design, arresting the spread of fire or preventing glitch are recommended in order to prevent physical injury, fire, social damages, for example, by using the products.
- (6) Comply with the instructions for use in order to prevent breakdown and characteristics change due to external factors (ESD, EOS, thermal stress and mechanical stress) at the time of handling, mounting or at customer's process. When using products for which damp-proof packing is required, satisfy the conditions, such as shelf life and the elapsed time since first opening the packages.
- (7) This book may be not reprinted or reproduced whether wholly or partially, without the prior written permission of our company.

Компания «Океан Электроники» предлагает заключение долгосрочных отношений при поставках импортных электронных компонентов на взаимовыгодных условиях!

Наши преимущества:

- Поставка оригинальных импортных электронных компонентов напрямую с производств Америки, Европы и Азии, а так же с крупнейших складов мира;
- Широкая линейка поставок активных и пассивных импортных электронных компонентов (более 30 млн. наименований);
- Поставка сложных, дефицитных, либо снятых с производства позиций;
- Оперативные сроки поставки под заказ (от 5 рабочих дней);
- Экспресс доставка в любую точку России;
- Помощь Конструкторского Отдела и консультации квалифицированных инженеров;
- Техническая поддержка проекта, помощь в подборе аналогов, поставка прототипов;
- Поставка электронных компонентов под контролем ВП;
- Система менеджмента качества сертифицирована по Международному стандарту ISO 9001;
- При необходимости вся продукция военного и аэрокосмического назначения проходит испытания и сертификацию в лаборатории (по согласованию с заказчиком);
- Поставка специализированных компонентов военного и аэрокосмического уровня качества (Xilinx, Altera, Analog Devices, Intersil, Interpoint, Microsemi, Actel, Aeroflex, Peregrine, VPT, Syfer, Eurofarad, Texas Instruments, MS Kennedy, Miteq, Cobham, E2V, MA-COM, Hittite, Mini-Circuits, General Dynamics и др.);

Компания «Океан Электроники» является официальным дистрибьютором и эксклюзивным представителем в России одного из крупнейших производителей разъемов военного и аэрокосмического назначения «JONHON», а так же официальным дистрибьютором и эксклюзивным представителем в России производителя высокотехнологичных и надежных решений для передачи СВЧ сигналов «FORSTAR».



JONHON

«JONHON» (основан в 1970 г.)

Разъемы специального, военного и аэрокосмического назначения:

(Применяются в военной, авиационной, аэрокосмической, морской, железнодорожной, горно- и нефтедобывающей отраслях промышленности)

«FORSTAR» (основан в 1998 г.)

ВЧ соединители, коаксиальные кабели, кабельные сборки и микроволновые компоненты:

(Применяются в телекоммуникациях гражданского и специального назначения, в средствах связи, РЛС, а так же военной, авиационной и аэрокосмической отраслях промышленности).



Телефон: 8 (812) 309-75-97 (многоканальный)

Факс: 8 (812) 320-03-32

Электронная почта: ocean@oceanchips.ru

Web: <http://oceanchips.ru/>

Адрес: 198099, г. Санкт-Петербург, ул. Калинина, д. 2, корп. 4, лит. А