

DUAL VIDEO 6dB AMPLIFIER WITH 75Ω DRIVER

■ GENERAL DESCRIPTION

NJM2268 is a dual video 6dB amplifier with 75Ω drivers for S-VHS VCRs, HI-BAND VCRs, etc..One channel has clamp function that fixes DC level of video signal and another one is bias type. Furthermore it has 75Ω drivers to be connected to TV monitors directly and sag corrective circuits that prevent the generation of sag with smaller capacitance than ever.

Its operating supply voltage is 4.85 to 9V and bandwidth is 7MHz.

■ FEATURES

- Wide Operating Voltage (4.85 to 9.0V)
- Dual Channel (Clamp Type, Bias Type)
- Internal Driver Circuit For 75Ω Load
- SAG Corrective Function
- Wide Frequency Range 7MHz
- Low Operating Current 14.0mA (Dual)
- Package Outline DIP8, DMP8, SSOP8
- Bipolar Technology

■ RECOMMENDED OPERATING CONDITION

- Operating Voltage V^+ 4.85 to 9.0V

■ APPLICATIONS

- VCR, Video Camera, TV, Video Disc Player

■ BLOCK DIAGRAM

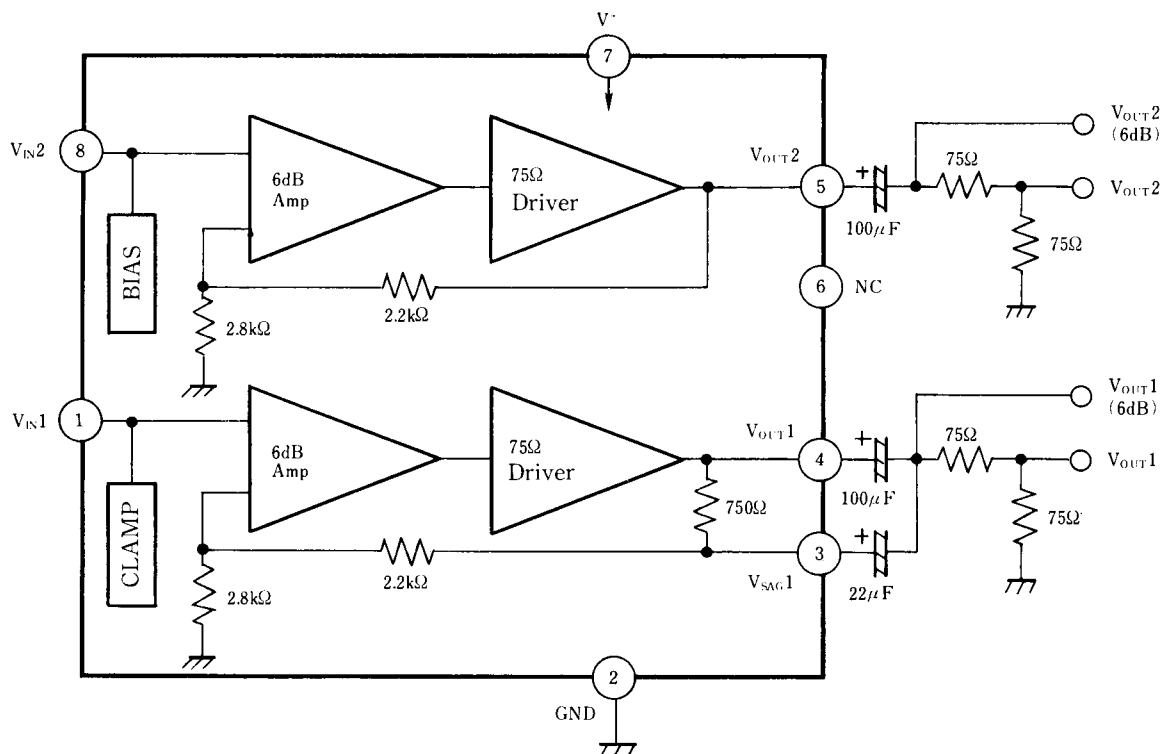

■ PACKAGE OUTLINE

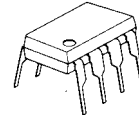

NJM2268D

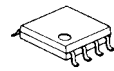

NJM2268M



NJM2268V

NJM2268

■ ABSOLUTE MAXIMUM RATINGS

(Ta=25°C)

PARAMETER	SYMBOL	RATINGS	UNIT
Supply Voltage	V ⁺	10	V
Power Dissipation	P _D	(DIP8) 500 (DMP8) 300 (SSOP8) 250	mW mW mW
Operating Temperature Range	T _{opr}	-40 to +85	°C
Storage Temperature Range	T _{stg}	-40 to +125	°C

■ ELECTRICAL CHARACTERISTICS

(V⁺=5V, Ta=25°C)

PARAMETER	SYMBOL	TEST CONDITION	MIN.	TYP.	MAX.	UNIT
Operating Current	I _{CC}	No Signal	-	14.0	18.2	mA
Voltage Gain	G _V	V _{IN} =1MHz, 1V _{P-P} Sinewave	5.7	6.2	6.7	dB
Frequency Characteristic	G _f	V _{IN} =1V _{P-P} , Sinewave, 7MHz / 1MHz	-	-	±1.0	dB
Differential Gain*	DG	V _{IN} =1V _{P-P} , Staircase	-	1.0	3.0	%
Differential Phase*	DP	V _{IN} =1V _{P-P} , Staircase	-	1.0	3.0	deg
Crosstalk	CT	V _{IN} =4.43MHz, 1V _{P-P} , Sinewave	-	-70	-	dB
Gain Offset	G _{CH}	V _{IN} =1MHz, 1V _{P-P} , G _{CH} =V _{OUT1} -V _{OUT2}	-	-	±0.5	dB
Input Clamp Voltage	V _{CL}		1.79	1.91	2.03	V
Input Bias Voltage	V _{BI}		2.56	2.84	3.12	V
SAG Terminal Gain	G _{SAG}		35	45	-	dB

NOTE: "*" is applied to clamp type input side only /

■ APPLICATION

Oscillation Prevention

It is much effective to insert LPF (Cutoff Frequency 70MHz) under light loading conditions (R_L » 1kΩ).

This IC requires 1MΩ resistance between INPUT and GND pin for clamp type input since the minute current causes an unstable pin voltage.

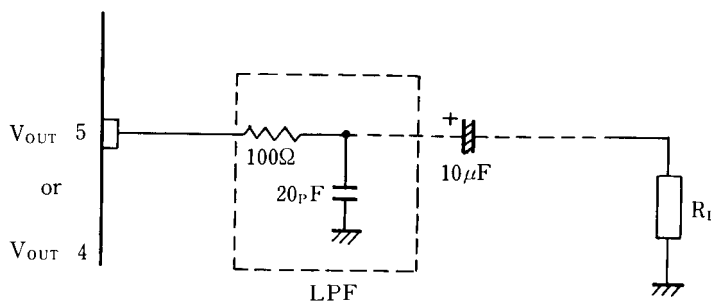

■ TEST CIRCUIT

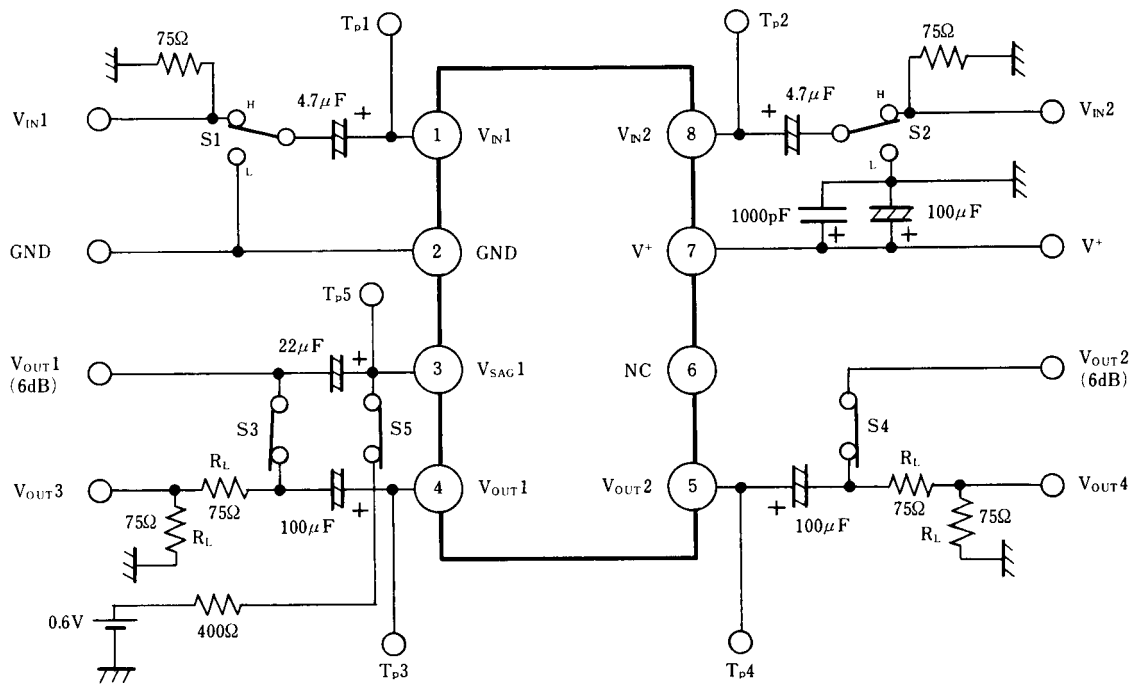

■ TEST METHODES

PARAMETER	SYMBOL	SWITCH CONDITIONS						CONDITIONS
		S1	S2	S3	S4	S5	S6	
Supply Current	I_{CC}	H	H					7PIN Sink Current
Voltage Gain	G_V	H	H	ON	ON			V_{OUT1} / V_{IN1} , V_{OUT2} / V_{IN2} at $V_{IN1}(V_{IN2})=1\text{MHz}$, $1V_{P-P}$, Sinewave
Frequency Characteristic	G_f	H	H	ON	ON			G_{V1M} ; Voltage Gain at V_{IN1} (V_{IN2})= 1MHz , $1V_{P-P}$ G_{V10M} ; Voltage Gain at V_{IN1} (V_{IN2})= 10MHz , $1V_{P-P}$ $G_f = G_{V10M} - G_{V1M}$
Differential Gain	DG	H	H	ON	ON			Measuring V_{OUT3} at V_{IN1} =Staircase Signal
Differential Phase	DP	H	H	ON	ON			Measuring V_{OUT3} at V_{IN1} =Staircase Signal
Crosstalk	CT	H	L	ON	ON			V_{OUT2} / V_{OUT1} at $V_{IN1}=4.43\text{MHz}$, $1V_{P-P}$, Sinewave V_{OUT1} / V_{IN2} at $V_{IN2}=4.43\text{MHz}$, $1V_{P-P}$, Sinewave
Gain Offset	G_{CH}	H	H	ON	ON			$G_{V1} = V_{OUT1} / V_{IN1}$, $G_{V2} = V_{OUT2} / V_{IN2}$ $G_{CH} = G_{V1} - G_{V2}$
Input Clamp Voltage	V_{CL}	H	H					Measuring at TP1
Input Bias Voltage	V_{Bt}	H	H					Measuring at TP2
SAG Terminal Gain	G_{SAG}	H	H			ON	ON	TP3 Voltage; V_{O1A} , TP5 Voltage; V_{SO1A} TP3 Voltage; V_{O1B} , TP5 Voltage; V_{SO1B} $G_{SAG} = 20 \log \{ (V_{O1B} - V_{O1A}) / (V_{SO1A} - V_{SO1B}) \}$

NJM2268

■ TERMINAL FUNCTION

($V^+ = 5.0V$, $T_a = 25^\circ C$)

PIN No.	PIN NAME	SYMBOL	EQUIVALENT CIRCUIT	FUNCTIONS
1	Input Clamp Terminal	V_{IN1}		Input terminal of $1V_{P-P}$ composite Signal or Y signal. Clamp level is 1.9V
2	GND	GND		Ground
3	SAG correction	V_{SAG1}		SAG caused by a coupling capacitor of the output can be prevented by connecting this terminal with the output terminal through an external capacitor.(see block diagram) When SAG correcting function is not necessary, this terminal must be connected with pin "4" directly.
4	Video Output1	V_{OUT1}		Output terminal (clamp side) that can drive 75Ω line.
5	Video Output2	V_{OUT2}		Output terminal (bias side) that can drive 75Ω line.
6	No Connection	NC		
7	V^+	V^+		Supply Voltage
8	Input Clamp Terminal	V_{IN2}		Input terminal of $1V_{P-P}$ coler signal. Bias level is 2.8V.

■ TYPICAL CHARACTERISTICS

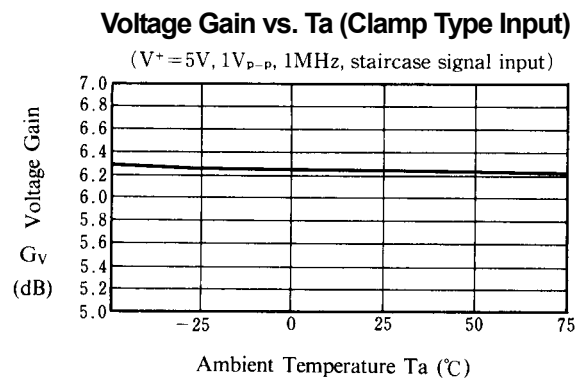
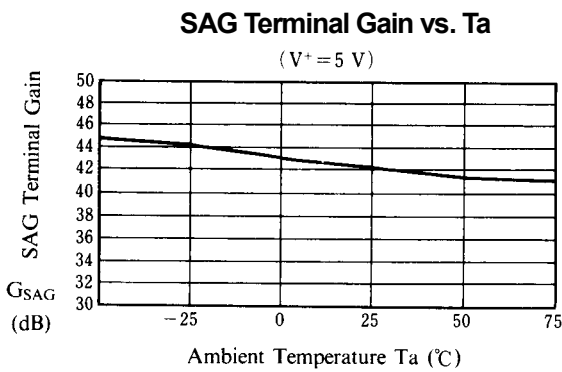
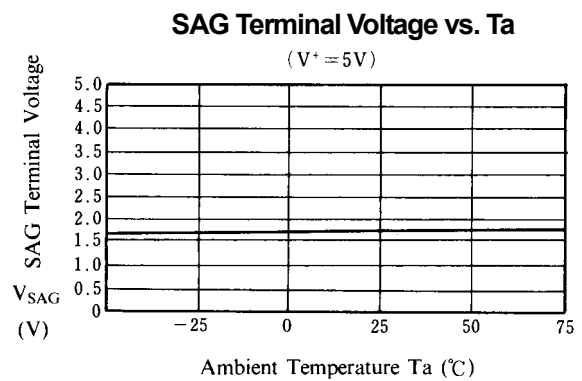
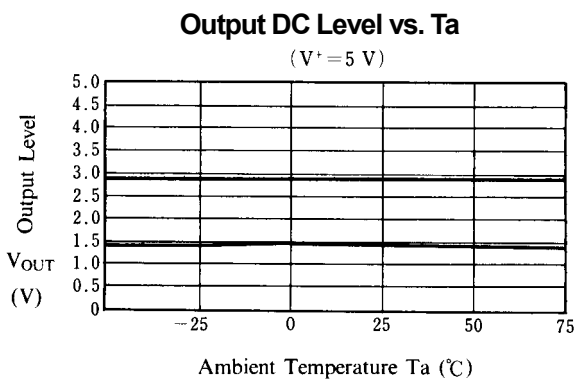
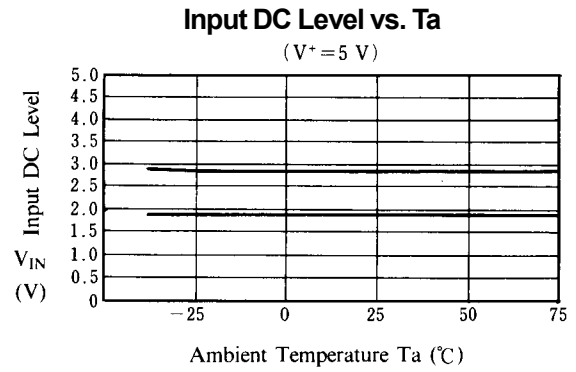
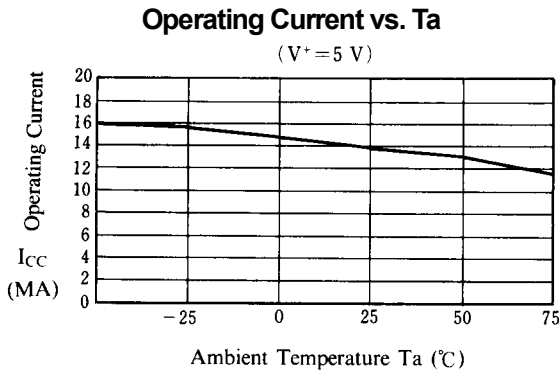

■ TYPICAL CHARACTERISTICS

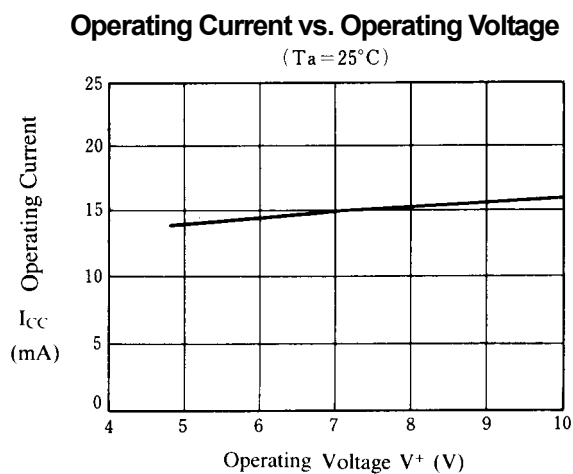
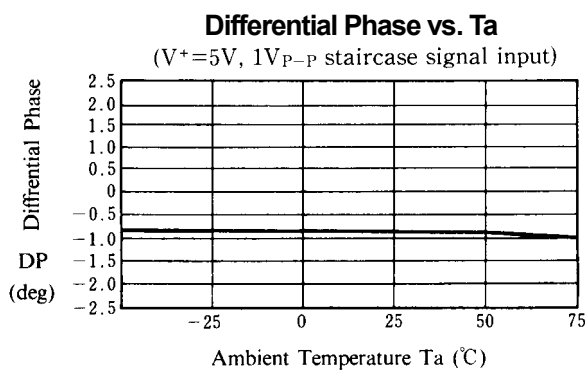
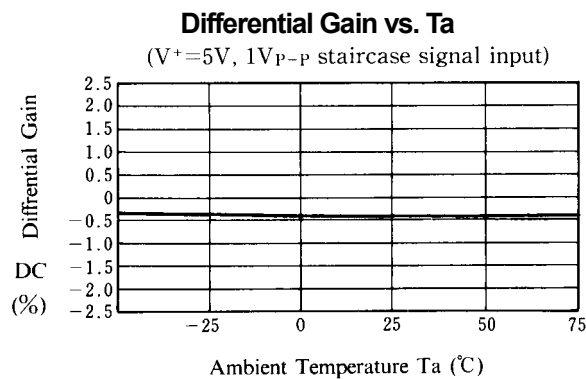
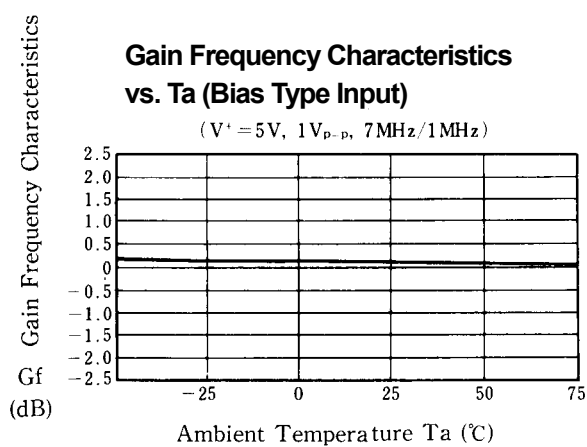
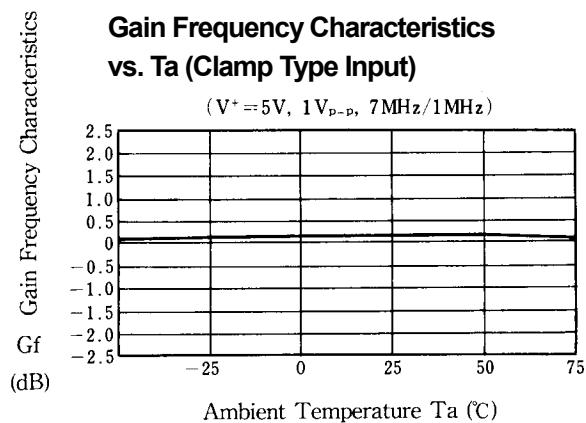
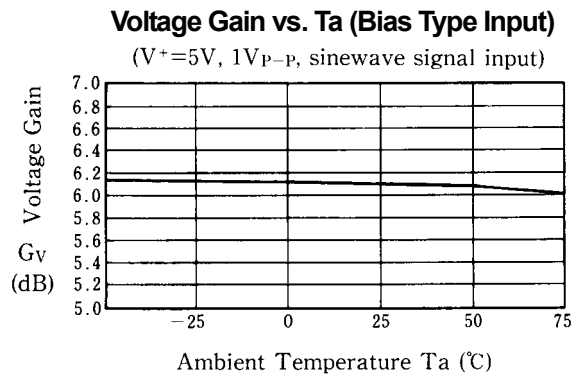

■ TYPICAL CHARACTERISTICS

Input DC Level vs. Operating Voltage

($T_a = 25^\circ\text{C}$)

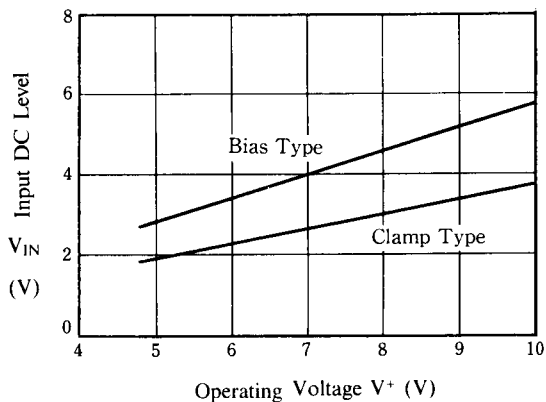

Output DC Level vs. Operating Voltage

($T_a = 25^\circ\text{C}$)

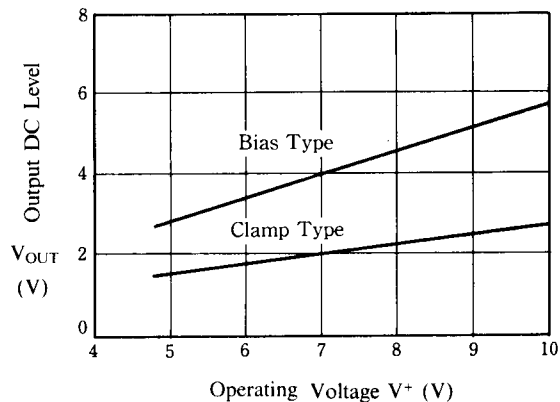

SAG Terminal Voltage vs. Operating Voltage

($T_a = 25^\circ\text{C}$)

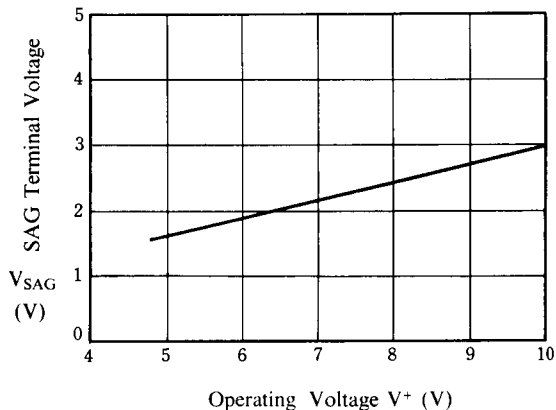

SAG Terminal Gain vs. Operating Voltage

($T_a = 25^\circ\text{C}$)

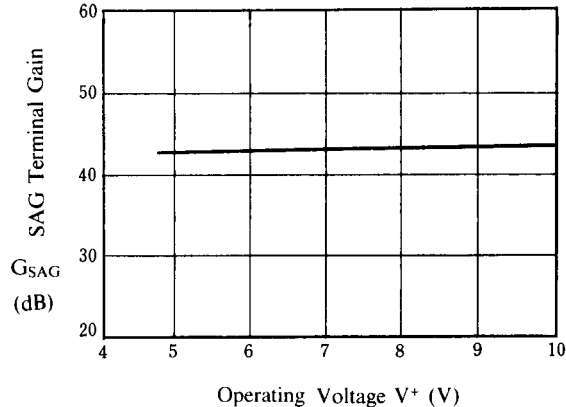

Voltage Gain vs. Operating Voltage (Clamp Type Input)

($T_a = 25^\circ\text{C}$, $1V_{P-P}$, 1MHz sinewave signal input)

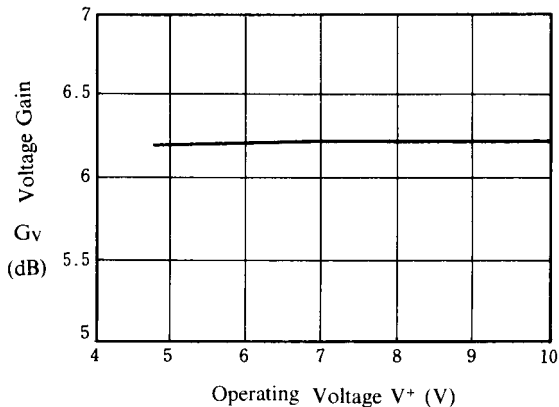

Voltage Gain vs. Operating Voltage (Bias Type Input)

($T_a = 25^\circ\text{C}$, $1V_{P-P}$, 1MHz sinewave signal input)

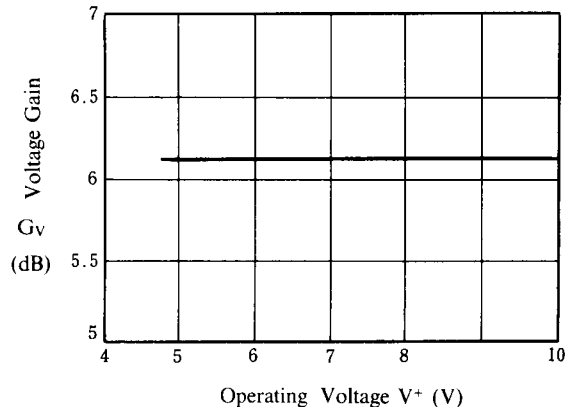

■ TYPICAL CHARACTERISTICS

Gain Frequency Characteristics vs. Operating Voltage (Clamp Type Input)
($T_a = 25^\circ\text{C}$, $1V_{p-p}$, 7MHz/1MHz)

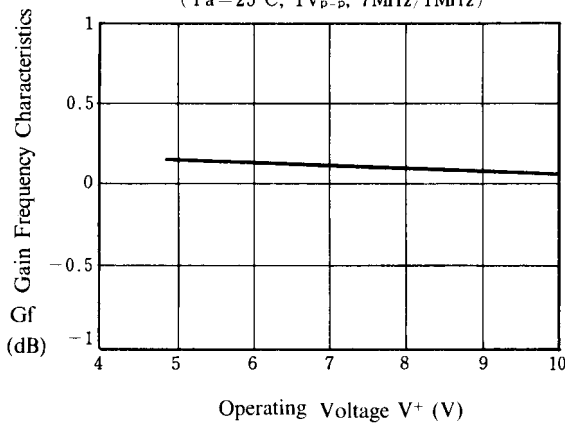

Gain Frequency Characteristics vs. Operating Voltage (Bias Type Input)
($T_a = 25^\circ\text{C}$, $1V_{p-p}$, 7MHz/1MHz)

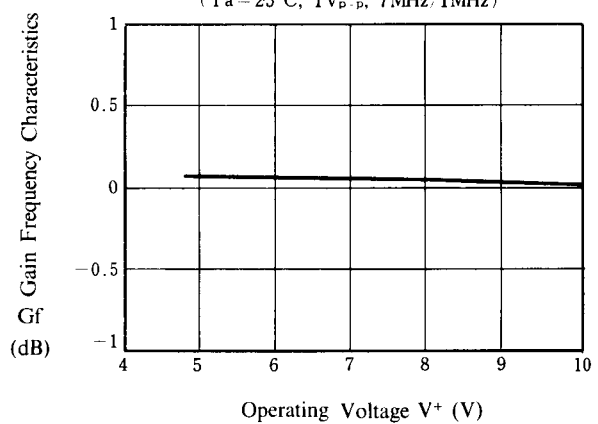

Differential Gain vs. Operating Voltage
($T_a = 25^\circ\text{C}$, $1V_{p-p}$, staircase signal input)

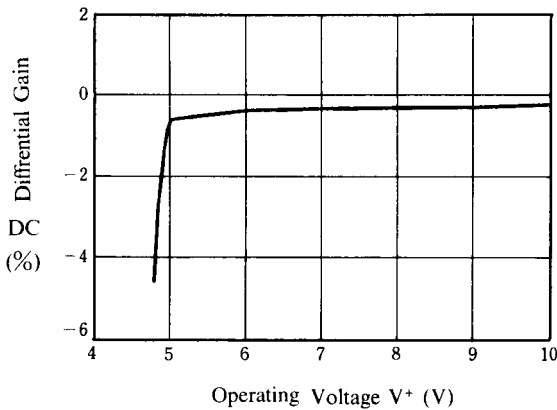

Differential Phase vs. Operating Voltage
($T_a = 25^\circ\text{C}$, $1V_{p-p}$, staircase signal input)

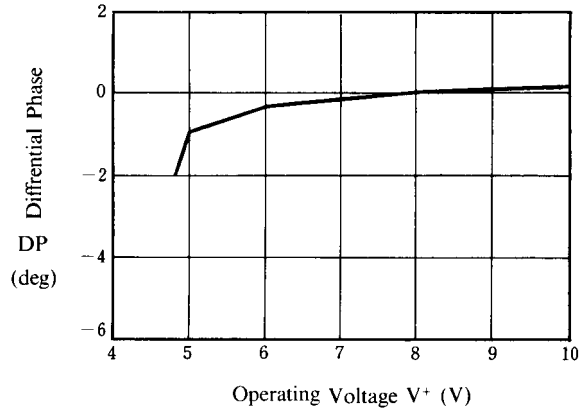

Voltage Gain vs. Frequency (Clamp Type Input)
($T_a = 25^\circ\text{C}$, $V^+ = 5V$, $1V_{p-p}$ sinewave signal input)

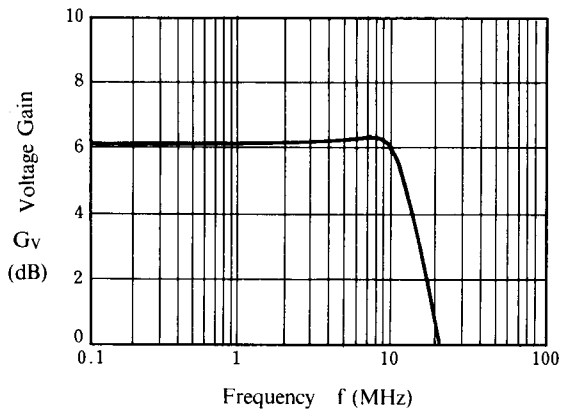

Voltage Gain vs. Frequency (Bias Type Input)
($T_a = 25^\circ\text{C}$, $V^+ = 5V$, $1V_{p-p}$ sinewave signal input)

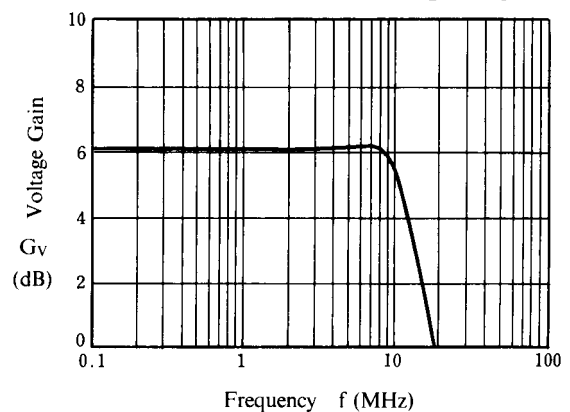

■ TYPICAL CHARACTERISTICS

Small Signal Voltage Gain vs. Frequency (Clamp Type Input)

($T_a=25^\circ\text{C}$, $V^+=5V_{P-P}$, $25mV_{P-P}$ sinewave signal input)

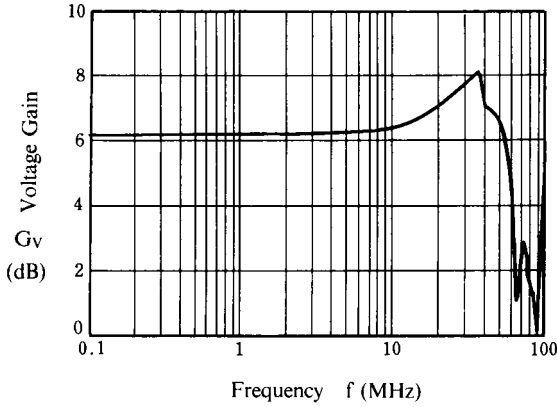

Small Signal Voltage Gain vs. Frequency (Bias Type Input)

($T_a=25^\circ\text{C}$, $V^+=5V$, $25mV_{P-P}$ sinewave signal input)

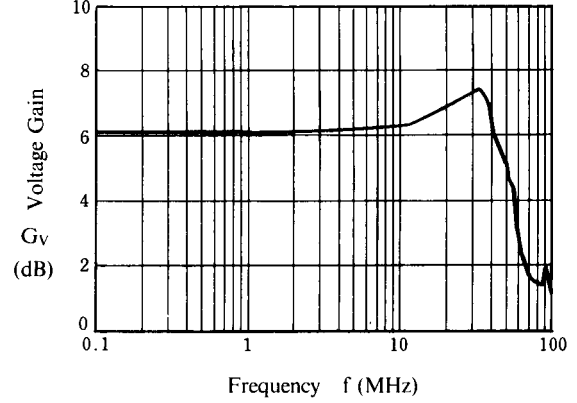

Cross Talk vs. Frequency

($T_a=25^\circ\text{C}$, $V^+=5V$, $1V_{P-P}$ sinewave signal input)

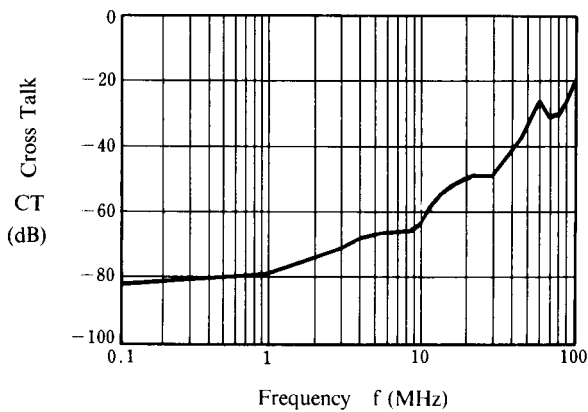

Voltage Gain vs. R_L (Clamp Type Input)

($T_a=25^\circ\text{C}$, $V^+=5V$, $1V_{P-P}$, 1MHz, sinewave signal input)

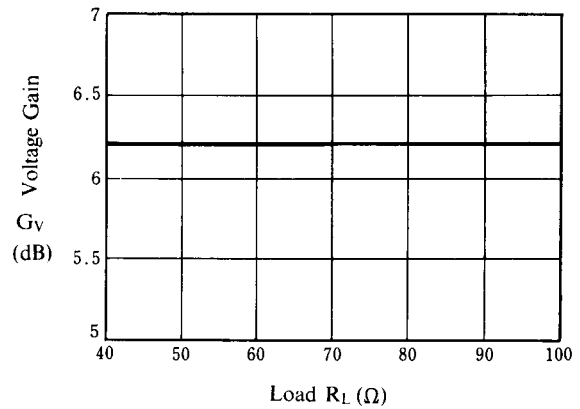

Voltage Gain vs. R_L (Bias Type Input)

($T_a=25^\circ\text{C}$, $V^+=5V$, $1V_{P-P}$, 1MHz sinewave signal input)

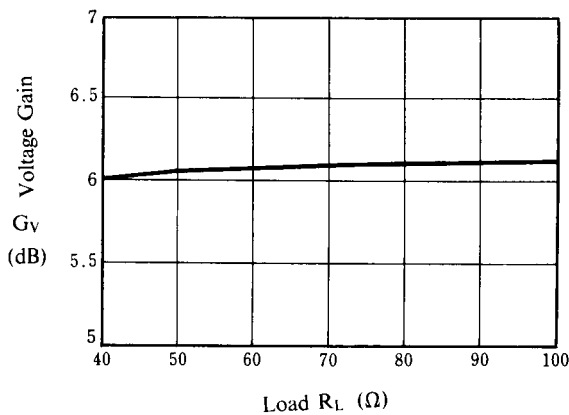

Gain Frequency Characteristics vs. R_L (Clamp Type Input)

($T_a=25^\circ\text{C}$, $V^+=5V$, $1V_{P-P}$, 7MHz/1MHz)

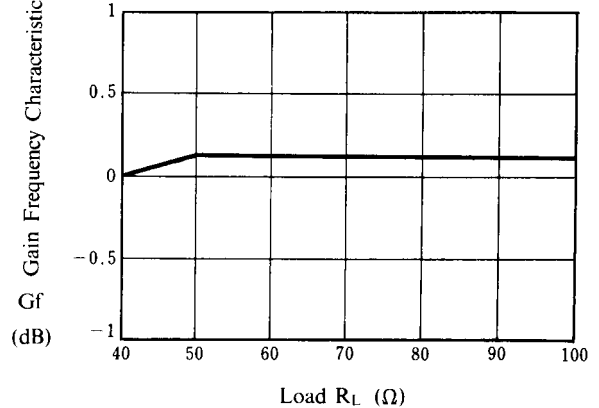

■ TYPICAL CHARACTERISTICS

Gain Frequency Characteristics vs. R_L (Bias Type Input)

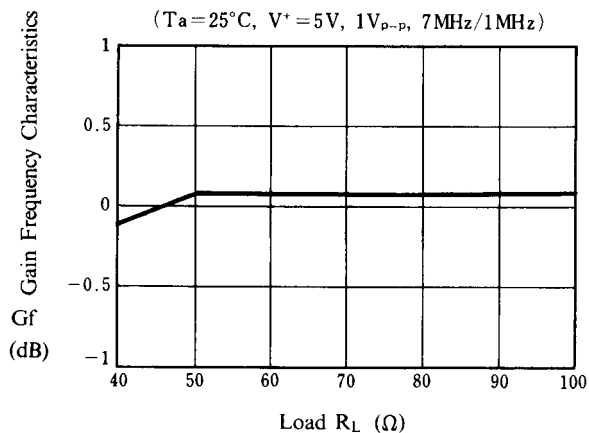

Differential Gain vs. R_L

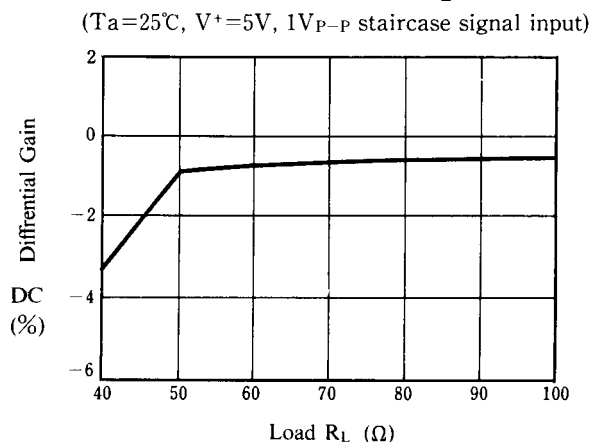

Differential Phase vs. R_L

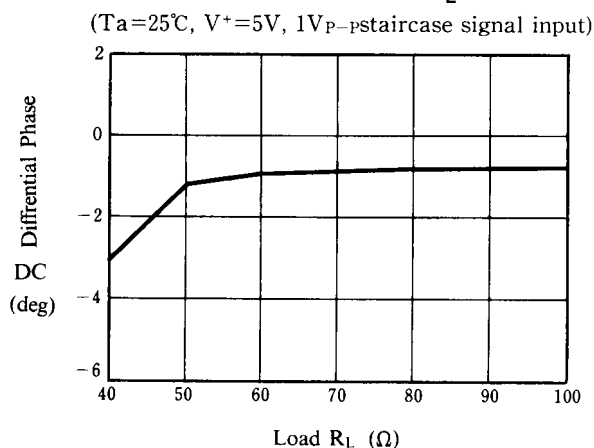

Differential Gain vs. APL

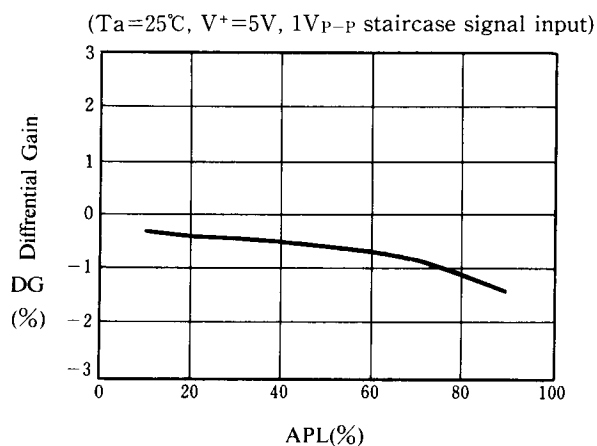

Differential Phase vs. APL

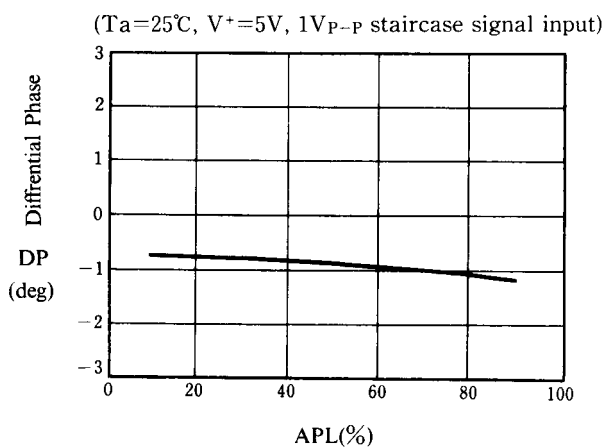

■ APPLICATION

This IC requires 1MΩ resistance between INPUT and GND pin for clamp type input since the minute current causes an unstable pin voltage.

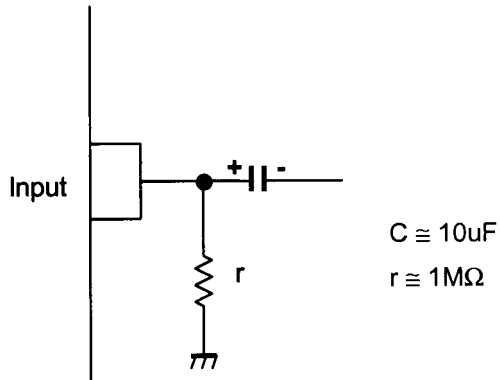

[CAUTION]

The specifications on this databook are only given for information, without any guarantee as regards either mistakes or omissions. The application circuits in this databook are described only to show representative usages of the product and not intended for the guarantee or permission of any right including the industrial rights.

Mouser Electronics

Authorized Distributor

Click to View Pricing, Inventory, Delivery & Lifecycle Information:

[NJR:](#)

[NJM2268M](#) [NJM2268D](#) [NJM2268M-T1](#) [NJM2268V](#)

Компания «Океан Электроники» предлагает заключение долгосрочных отношений при поставках импортных электронных компонентов на взаимовыгодных условиях!

Наши преимущества:

- Поставка оригинальных импортных электронных компонентов напрямую с производств Америки, Европы и Азии, а так же с крупнейших складов мира;
- Широкая линейка поставок активных и пассивных импортных электронных компонентов (более 30 млн. наименований);
- Поставка сложных, дефицитных, либо снятых с производства позиций;
- Оперативные сроки поставки под заказ (от 5 рабочих дней);
- Экспресс доставка в любую точку России;
- Помощь Конструкторского Отдела и консультации квалифицированных инженеров;
- Техническая поддержка проекта, помощь в подборе аналогов, поставка прототипов;
- Поставка электронных компонентов под контролем ВП;
- Система менеджмента качества сертифицирована по Международному стандарту ISO 9001;
- При необходимости вся продукция военного и аэрокосмического назначения проходит испытания и сертификацию в лаборатории (по согласованию с заказчиком);
- Поставка специализированных компонентов военного и аэрокосмического уровня качества (Xilinx, Altera, Analog Devices, Intersil, Interpoint, Microsemi, Actel, Aeroflex, Peregrine, VPT, Syfer, Eurofarad, Texas Instruments, MS Kennedy, Miteq, Cobham, E2V, MA-COM, Hittite, Mini-Circuits, General Dynamics и др.);

Компания «Океан Электроники» является официальным дистрибьютором и эксклюзивным представителем в России одного из крупнейших производителей разъемов военного и аэрокосмического назначения «**JONHON**», а так же официальным дистрибьютором и эксклюзивным представителем в России производителя высокотехнологичных и надежных решений для передачи СВЧ сигналов «**FORSTAR**».



JONHON

«**JONHON**» (основан в 1970 г.)

Разъемы специального, военного и аэрокосмического назначения:

(Применяются в военной, авиационной, аэрокосмической, морской, железнодорожной, горно- и нефтедобывающей отраслях промышленности)

«**FORSTAR**» (основан в 1998 г.)

ВЧ соединители, коаксиальные кабели,
кабельные сборки и микроволновые компоненты:

(Применяются в телекоммуникациях гражданского и специального назначения, в средствах связи, РЛС, а так же военной, авиационной и аэрокосмической отраслях промышленности).



Телефон: 8 (812) 309-75-97 (многоканальный)

Факс: 8 (812) 320-03-32

Электронная почта: ocean@oceanchips.ru

Web: <http://oceanchips.ru/>

Адрес: 198099, г. Санкт-Петербург, ул. Калинина, д. 2, корп. 4, лит. А