



FEATURES

- Lowest cost
- Lowest power, 2mW
- Subminiature size:
1.38" x 0.88" x 0.43"
35mm x 22mm x 11mm
- Large (0.37"/9.4mm), enhanced-contrast LCD display
- Epoxy-encapsulated, 12-pin DIP
- Panel or pc-board mountable
- 4 differential input voltage ranges
- High accuracy, ± 1 count ($\pm 0.05\%$)
- Single +5V supply or 9V battery
- Low-battery annunciator
- User-selectable decimal point placement
- 0 to +60°C temperature range

DMS-20LCD Series, 3½ Digit, LCD Display, Digital Voltmeters represent the ultimate combination of low price, low power, small size and high performance in digital meters. Epoxy encapsulated in a subminiature (1.38" x 0.88" x 0.43"), 12-pin DIP package, these completely self-contained, fully operational meters offer a combination of ruggedness, long-term reliability and component-like ease-of-use simply not available in any other meters.

Incorporating a precision reference and a factory-calibrated, autozeroing A/D converter, DMS-20LCD meters are extremely accurate (± 1 count) and are only slightly larger than their 0.37"/9.4mm, enhanced-contrast, LCD displays. All models incorporate a built-in bezel and are easily mounted in either panels or pc boards. Both backlit and non-backlit versions are available.

DMS-20LCD meters have 4 differential input voltage ranges ($\pm 200\text{mV}$, $\pm 2\text{V}$, $\pm 20\text{V}$ and $\pm 200\text{V}$) and a user-friendly input structure. Input impedance is a minimum $800\text{k}\Omega$. CMRR is typically 86dB with a CMV of $\pm 2\text{V}$. Non-inverting inputs are overvoltage protected to $\pm 100\text{V}$ ($\pm 250\text{V}$ for the $\pm 200\text{V}$ input model).

All DMS-20LCD meters operate from a single +5V supply (drawing $400\mu\text{A}$) or a single +9V supply/battery (drawing $230\mu\text{A}$). All models have a low-battery ("B") annunciator and feature autopolarity changeover and overrange indication.

Also available is an application/evaluation board (DMS-EB2) that plugs directly onto the back of any DMS-20LCD allowing direct inputs for common applications such as 4-20mA inputs, zero/gain adjust, decimal point location, and input voltage dividing.

SIMPLIFIED SCHEMATIC DIAGRAM

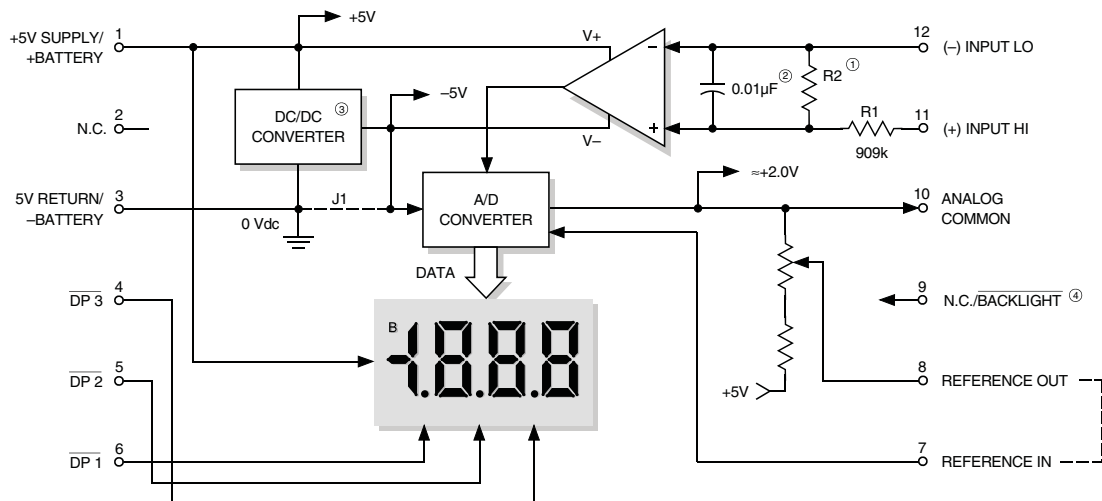

- ① R2 is not used on $\pm 200\text{mV}$ (-0) models or $\pm 2\text{V}$ (-1) models.
R2 = 100k on $\pm 20\text{V}$ (-2) models and 9.1k on $\pm 200\text{V}$ (-3) models.
② Only used on $\pm 200\text{mV}$ (-0) and $\pm 2\text{V}$ (-1) models.

- ③ DC/DC converter is not used on 9V-powered models, J1 is connected.
④ Used on backlit models only.
N.C. for non-backlit models.



For full details go to
www.murata-ps.com/rohs

Performance/Functional Specifications

Typical at T_A = +25°C and supply voltage = +5V (using the single-ended input circuit) or +9V (using the differential input circuit), unless otherwise noted.

Analog Inputs	Min.	Typ.	Max.	Units
Full Scale Input Range:				
DMS-20LCD-0	–	±200	–	mV
DMS-20LCD-1	–	±2	–	Volts
DMS-20LCD-2	–	±20	–	Volts
DMS-20LCD-3	–	±200	–	Volts
Input Impedence:				
DMS-20LCD-0, -1	100	1000	–	MΩ
DMS-20LCD-2, -3	0.8	1	–	MΩ
Overvoltage Protection ①				
DMS-20LCD-0, -1, -2	–	–	±100	Volts
DMS-20LCD-3	–	–	±250	Volts
Common Mode Voltage Range				
	–	–	±2	Volts
CMRR (dc to 60Hz)				
	–	86	–	dB
Control Inputs ②				
Decimal Pt. Placement (Pins 4-6)	Tie to pin 3 to activate			
Functionality	Tie to pin 3 to activate			
Logic Compatibility	TTL (on 5V-powered models)			
Backlight (Pin 9)	Tie to pin 3 to turn on backlight			
Performance				
Sampling Rate	2.5 reading per second			
Accuracy (1 minute warm-up):				
DMS-20PC-0 (Vin = +0.19V)	–	±1	±2	Counts
DMS-20PC-1 (Vin = +1.9V)	–	±1	±2	Counts
DMS-20PC-2 (Vin = +19V)	–	±2	±3	Counts
DMS-20PC-3 (Vin = +190V)	–	±2	±3	Counts
Zero Reading (Vin = 0 Volts)	"–001"	"000"	"001"	
Temperature Drift (0 = +60°C)	–	±0.2	±0.4	Cnts/°C
Power Supply Requirements (5V Models)				
Supply Voltage	+4.75	+5.00	+5.25	Volts
Supply Current:				
Standard Models	–	+400	+650	μA
Backlit Models	–	+35	+50	mA
Power Supply Requirements (9V Models)				
Supply Voltage	+7.5	+9.0	+14.0	Volts
Supply Current:				
Standard Models	–	+230	+350	μA
Backlit Models	–	+35	+50	mA
Display				
Display Type and Size	3½ digit, 0.37"/9.4mm high LCD			
Polarity Indication	Autopolarity ("–" for negative Vin)			
Overrange Indication	"–1_ _" for negative Vin "1_ _" for positive Vin			

Physical/Environmental				
Operating Temperature	0	–	+60	°C
Storage Temperature	–20	–	+75	°C
Humidity (non-condensing)	0	–	95	%
Case Material	Polycarbonate			
Weight	0.4 ounces (11 grams)			

- ① Applies for transient or continuous overvoltages applied to (+) INPUT HI (pin 11) with (–) INPUT LO (pin 12) properly connected. Pin 12 is not overvoltage protected (see Figure 1). Voltages applied to pin 12 should not exceed the supply voltage.
- ② Listed spec applies to 5V-powered models only. For 9V-powered models, both (–) INPUT LO (pin 12) and (+) INPUT HIGH (pin 11) must always be at least 1.5V above –BATTERY (pin 3) and at least 1.5V below +BATTERY (pin 1).
- ③ See Technical Notes.

Ordering Information

DMS-20LCD - 1 - 5 - C

Input Range:
 0 = ±200mV
 1 = ±2V
 2 = ±20V
 3 = ±200V

Power Source:
 5 = +5V
 9 = +9V

Accessories:

- DMS-20-CP** Panel cutout punch
- DMS-BZL3-C** DMS-20 bezel assembly
- DMS-BZL4-C** DMS-20 bezel assembly with sealing gasket
- DMS-EB2-C** Application/evaluation board with standard MOLEX connector, decimal point solder pads and attenuation resistor pads.

– C Add -C for RoHS
 Leave blank for standard models.
 Add **B** for backlit models.



A panel-mount retaining clip is supplied with each model.

TECHNICAL NOTES

- 1. REFERENCE OUTPUT (Pin 8) and INPUT (Pin 7):** Pin 8 is a precision reference actively trimmed at the factory. In normal operation, pin 8 must be tied to pin 7 to achieve all listed accuracy and drift specifications.
- 2. ANALOG COMMON (Pin 10):** This pin is connected to an internal, low-noise, "relative" ground. It is used in certain differential and "floating" measurements as described in the Applications section of this data sheet and Ap Note 3 of the DATEL Panel Meter Catalog. **Pin 10 should not be connected to pin 3 (5V RETURN/–BATTERY) or to your system's analog ground.**
- 3. Decimal Point Placement:** The location of the decimal point is user-selectable, and the decimal point control pins (DP1-DP3) are active low functions. Select the appropriate decimal point by tying the appropriate pin (pin 4, 5 or 6) to pin 3 (5V RETURN/–BATTERY). Unused decimal

point location pins should be left open. For 5V-powered models, the decimal location pins are TTL compatible and may be hard wired as described above or driven with 5V TTL logic gates.

4. BACKLIGHT (Pin 9) Function: Grounding pin 9 (i.e. connecting it to pin 3) turns on the backlighting LED's. For non-backlit models, pin 9 has no internal connection. All backlit models include internal current-limiting resistors. With nominal +5V or 9V supplies, backlit devices typically draw 35mA of supply current. The current drawn by the backlight (and therefore the current drawn by the meter) can be reduced by installing a 1/4 Watt resistor between pins 3 and 9. The brightness of the meter will be reduced proportionately.

9V-powered backlit models function with supply voltages up to +14V, however, activating the backlight with voltages greater than 9.2V can damage the meter. Therefore, a 1/4 Watt series resistor must be installed between pins 3 and 9 in these situations. The value of the series resistor is determined using the following formula:

$$R_{Series} = \frac{+BATTERY - 9.2V}{0.035} \text{ Ohms}$$

Example: If +BATTERY (pin 1 with respect to pin 3) is +12.6V,

$$R_{Series} = \frac{+12.6 - 9.2V}{0.035} \text{ Ohms}$$

$$R_{Series} = 97 \text{ Ohms}$$

5. Low Battery Annunciator: The "B" annunciator in the upper left-hand corner of the display turns on when the supply voltage for 5V-powered models falls below approximately +3.7V, or when the supply voltage for 9V-powered models falls below approximately 7.2V. However, the low-battery annunciator's turn-on threshold can vary significantly from unit-to-unit: as low as 2.7V for 5V-powered meters, and as low as 5.4V for 9V-powered models. Applications that use the LOW BAT annunciator must be fully tested by the user, using a combination of low supply voltages and the input signal's minimum and maximum levels, to ensure that all display readings are valid as long as the LOW BAT annunciator remains off.

6. Gain Adjust: There is a gain-adjust potentiometer on the back of each meter. It has approximately ±50 counts (±2.5%) range of adjustment. Since these devices essentially have no zero/offset errors, a gain adjustment is effectively an overall accuracy adjustment. Though they may be performed at any point (except zero), accuracy adjustments are most effective when performed with higher level input signals. The circuit shown in Figure 9 provides ±10% range of adjustment.

7. Soldering Methods: All models in the DMS-20LCD Series easily withstand most common wave soldering operations. We recommend, however, that you evaluate the effects your particular soldering techniques may have on the meter's plastic case and high-precision electrical performance. We recommend the use of no-clean solders.

8. Suggested Mating Connectors:

Panel mounted:

Connector housing	DATEL P/N 4320-01069-0
Terminal type	DATEL P/N 4400-01032-0
Crimping tool	DATEL P/N 39-2099000
Wire size	22 to 26 AWG
Insulation diameter	0.062" (1.57mm) maximum
Stripping length	0.100 to 0.125" (2.54 to 3.17mm)

Board mounted:

Socket	DATEL P/N 4320-01074-0
---------------	------------------------

APPLICATIONS

DMS-20LCD meters are available in either 5V-powered or 9V-powered models. 9V devices operate directly from 7.5V to 14V supplies (usually batteries) without the need for external voltage regulators. 9V devices, however, can not be used to measure voltages referenced to the negative battery terminal (pin 3) because the minus input to the meter (pin 12, (-) INPUT LO) must always be at least 1.5V above pin 3. 9V-powered meters can only be used to make differential and not single-ended measurements.

5V-powered devices operate from any well-regulated +5V supply and will accurately measure voltages both above and below pin 3 (5V RETURN) in either single-ended or differential configurations.

1. Single-Ended Input Configurations: True single-ended measurements can only be made with 5V-powered meters. The circuit of Figure 2 avoids problems normally associated with ground-loop currents. Separate ground runs should be used for 5V RETURN (pin 3) and (-) INPUT LO (pin 12).

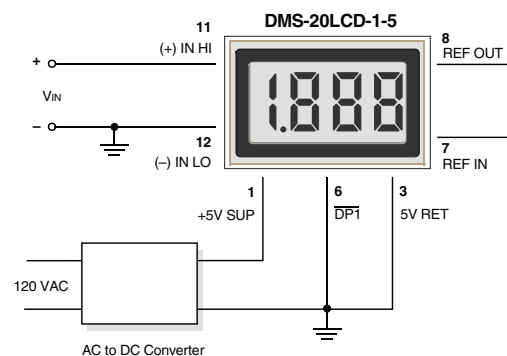

Figure 2. Single-Ended Input Configuration (5V-Powered Models)

APPLICATIONS

2. Differential Input Configurations: Differential measurements can be made with either 5V-powered or 9V-powered meters. Figure 3, though not a practical real-world application, uses a voltage divider to demonstrate the concept of a differential input signal. Be careful not to exceed the ±2V common mode voltage limitation for 5V powered meters.

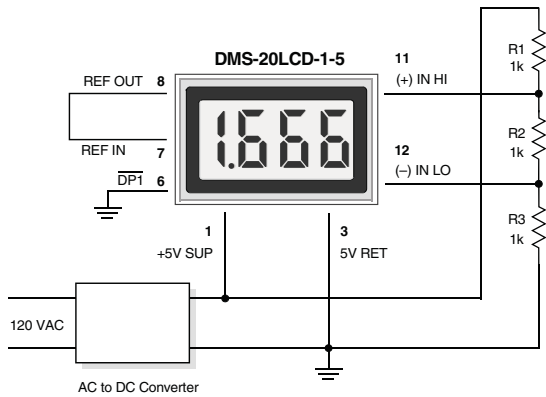

Figure 3. Differential Input Configuration (5V-Powered Models)

3. Engineering Scaling: For measuring voltages greater than the full scale input range of a given meter, the input signal must be attenuated. A simple voltage divider (similar to that shown in Figure 4) will scale the input to within the range of the selected meter. R1 and R2 should be precision, ±1%, metal-film resistors with absolute TCR's less than 50ppm/°C. See Ap Note 4 for more information on engineering scaling.

$$50k\Omega < R1 + R2 < 10M\Omega$$

$$\frac{R2}{R1 + R2} \times V_{IN} = \text{Reading}$$

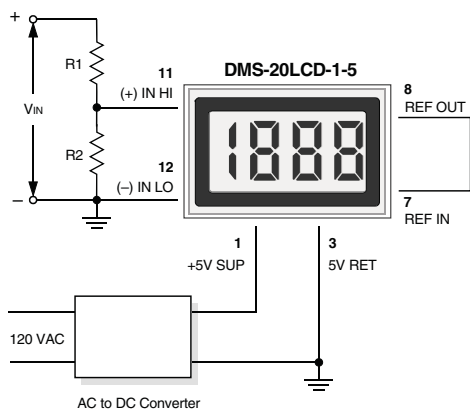

Figure 4. Input Attenuation Circuit

4. Floating Signal Source Measurements: Floating signals can be measured using the circuits shown in Figures 5 and 6. Figure 5 uses a 5V-powered meter. Figure 6 uses a 9V-powered meter. Connecting pin 10 (ANALOG COMMON) to (-) INPUT LO (pin 12) provides the reference point for the meter's input.

A “floating” input is a signal that has no galvanic connection to the meter’s power supply. In the figures below, the 1.5V battery illustrates a true floating input.

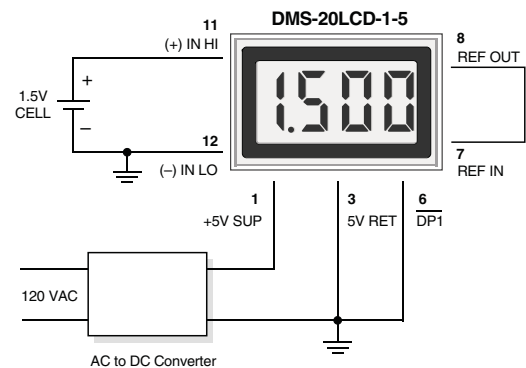

Figure 5. Floating Input Measurements (5V-Powered Models)

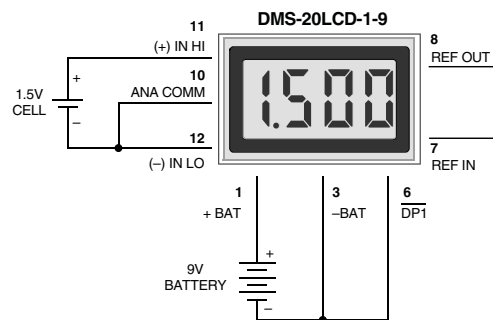

Figure 6. Floating Input Measurements (9V-Powered Models)

5. Process Control (4-to-20mA) Measurements: In many common process-control applications, a 4-to-20mA current loop is used to transmit information. Because DMS-20LCD meters have such high input impedance, a simple shunt resistor across the meter’s input can be used to convert the loop current to a voltage. See Figure 7. The value of the shunt resistor is a function of the scaling requirements of the particular application and can be calculated using the following equation:

APPLICATIONS

$$R_{Shunt} = R1 = V_{Fsr} / I_{Fsr}$$

Where: V_{Fsr} = Full scale reading (in Volts)

I_{Fsr} = Relative full scale current (in Amps)

Example: For a meter with a 2V full scale input (1.999 full scale reading) and a desired full scale display reading of 1000 (with an input of 20mA), $V_{Fsr} = 1.000$ Volts

$$R_{Shunt} = 1.000V / (0.020 - 0.004)A$$

$$R_{Shunt} = 1.000V / 0.016A = 62.5 \text{ Ohms}$$

To calibrate the circuit of Figure 7, perform the following:

1. With 4mA applied, adjust the 50kΩ potentiometer (R2) to display a reading of "000" (assuming that is the desired reading).
2. With 20mA applied, adjust the gain-adjust potentiometer on the back of the meter to display a reading of "1999". For different full scale readings, alter the value of R_{Shunt} accordingly.

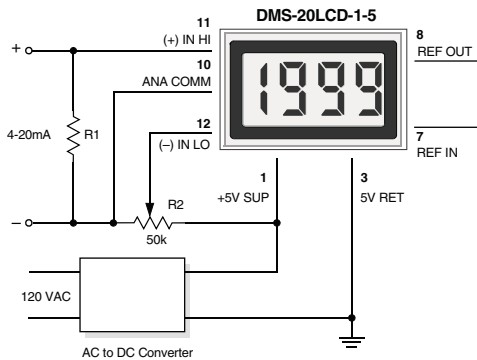

Figure 7. 4-to-20mA Current Loop Operation (5V-Powered Models)

6. Power Supply Monitoring: A popular application for DATEL's low-power LCD meters is monitoring the supply voltage in battery-operated portable equipment. Figure 8 demonstrates how a 9V-powered DMS-20LCD can be used to monitor its own supply. The meter used is the DMS-20LCD-1-9. A three-resistor voltage divider is used to attenuate the battery voltage and also to satisfy the requirement that the input voltages applied to pins 12 and 11 be at least 1.5 Volts above and below the battery voltage applied to pins 1 (+BATTERY) and 3 (-BATTERY). The divider should be designed so that 1/10th the battery voltage falls across the inputs to the meter:

$$\frac{R2}{(R1 + R2 + R3)} = 0.1$$

Therefore, the 9V battery voltage appears to the meter inputs as 0.9V. With the decimal point moved to its DP2 position (pin 5 tied to pin 3), the meter reads 9.00 Volts.

The circuit can be calibrated by first measuring the actual battery voltage with another meter and then adjusting the gain-adjust potentiometer on the back of the DMS-20LCD until a similar reading is obtained. If possible, the resistors in the divider should be ±1% metal-film types with TCR's less than 50ppm/°C.

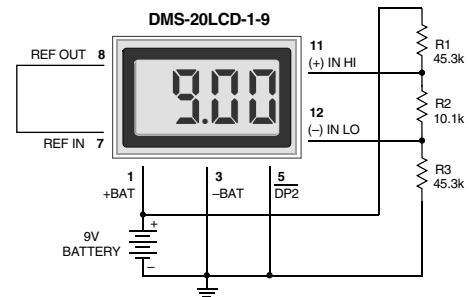

Figure 8. Power Supply Monitor (9V-Powered Models)

7. External Gain Adjustment: Connect REFERENCE OUT (pin 8) to REFERENCE IN (pin 7) for normal, factory calibrated, operation. Use the circuit shown in Figure 9 for applications needing external gain adjustment. Calibration is performed with a precise, near-full-scale, input voltage.

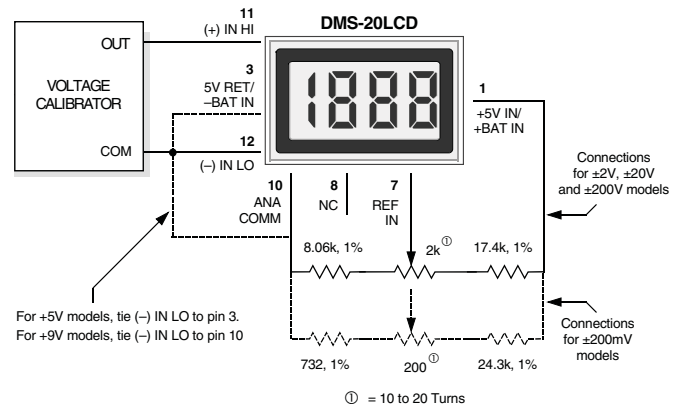
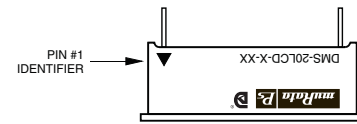
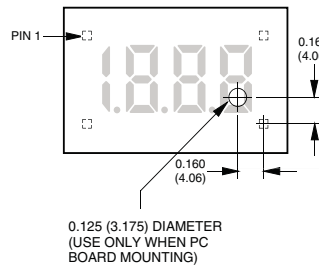

Figure 9. External Gain Adjustment

MECHANICAL SPECIFICATIONS

MECHANICAL DIMENSIONS: Inches (mm)
 TOLERANCES: 2 PL DEC ±0.02 (±0.51)
 3 PL DEC ±0.010 (±0.254)
 LEAD DIMENSIONS: 0.025 (0.635) x 0.025 (0.635) NOMINAL
 RECOMMENDED PC BOARD FINISHED HOLE DIAMETER:
 0.042 ±0.003 (1.067 ±0.076)

CALIBRATION POTENTIOMETER HOLE LOCATION



FRONT VIEW

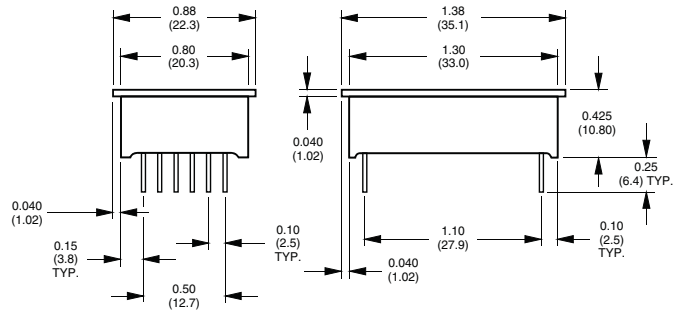
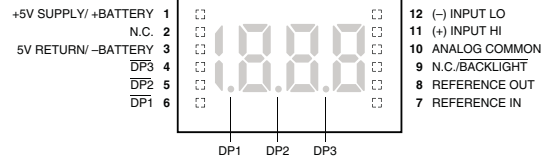

BEZEL INSTALLATION AND RECOMMENDED DRILL AND PANEL CUTOUT

OPTIONAL BEZEL (UWS-BZL3 AND UWS-BZL4)

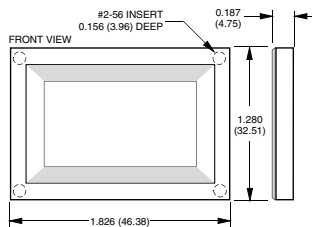

RECOMMENDED DRILL AND PANEL CUTOUT DIMENSIONS

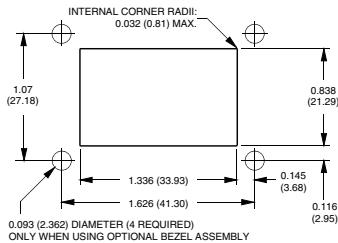

BEZEL INSTALLATION

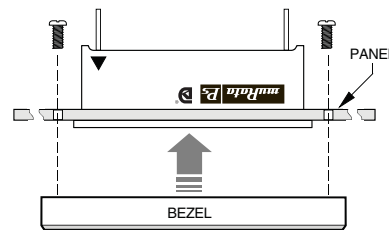

RETAINING CLIP INSTALLATION

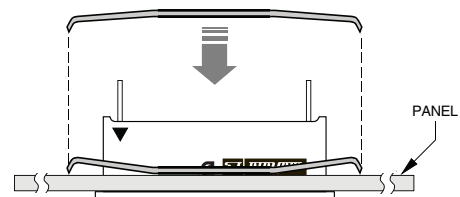

Murata Power Solutions, Inc.
 11 Cabot Boulevard, Mansfield, MA 02048-1151 U.S.A.
 ISO 9001 and 14001 REGISTERED

Murata Power Solutions, Inc. makes no representation that the use of its products in the circuits described herein, or the use of other technical information contained herein, will not infringe upon existing or future patent rights. The descriptions contained herein do not imply the granting of licenses to make, use, or sell equipment constructed in accordance therewith. Specifications are subject to change without notice.
 © 2011 Murata Power Solutions, Inc.

Компания «Океан Электроники» предлагает заключение долгосрочных отношений при поставках импортных электронных компонентов на взаимовыгодных условиях!

Наши преимущества:

- Поставка оригинальных импортных электронных компонентов напрямую с производств Америки, Европы и Азии, а так же с крупнейших складов мира;
- Широкая линейка поставок активных и пассивных импортных электронных компонентов (более 30 млн. наименований);
- Поставка сложных, дефицитных, либо снятых с производства позиций;
- Оперативные сроки поставки под заказ (от 5 рабочих дней);
- Экспресс доставка в любую точку России;
- Помощь Конструкторского Отдела и консультации квалифицированных инженеров;
- Техническая поддержка проекта, помощь в подборе аналогов, поставка прототипов;
- Поставка электронных компонентов под контролем ВП;
- Система менеджмента качества сертифицирована по Международному стандарту ISO 9001;
- При необходимости вся продукция военного и аэрокосмического назначения проходит испытания и сертификацию в лаборатории (по согласованию с заказчиком);
- Поставка специализированных компонентов военного и аэрокосмического уровня качества (Xilinx, Altera, Analog Devices, Intersil, Interpoint, Microsemi, Actel, Aeroflex, Peregrine, VPT, Syfer, Eurofarad, Texas Instruments, MS Kennedy, Miteq, Cobham, E2V, MA-COM, Hittite, Mini-Circuits, General Dynamics и др.);

Компания «Океан Электроники» является официальным дистрибьютором и эксклюзивным представителем в России одного из крупнейших производителей разъемов военного и аэрокосмического назначения «JONHON», а так же официальным дистрибьютором и эксклюзивным представителем в России производителя высокотехнологичных и надежных решений для передачи СВЧ сигналов «FORSTAR».



JONHON

«JONHON» (основан в 1970 г.)

Разъемы специального, военного и аэрокосмического назначения:

(Применяются в военной, авиационной, аэрокосмической, морской, железнодорожной, горно- и нефтедобывающей отраслях промышленности)

«FORSTAR» (основан в 1998 г.)

ВЧ соединители, коаксиальные кабели, кабельные сборки и микроволновые компоненты:

(Применяются в телекоммуникациях гражданского и специального назначения, в средствах связи, РЛС, а так же военной, авиационной и аэрокосмической отраслях промышленности).



Телефон: 8 (812) 309-75-97 (многоканальный)

Факс: 8 (812) 320-03-32

Электронная почта: ocean@oceanchips.ru

Web: <http://oceanchips.ru/>

Адрес: 198099, г. Санкт-Петербург, ул. Калинина, д. 2, корп. 4, лит. А