



TAOGLAS®



Datasheet

Torpedo

Part No:
AQHA.11.A.101111

Description:

Torpedo Permanent Mount GNSS L1 Antenna with 1m of RG-174 cable and SMA(M) connector

Features:

Permanent (Screw) Mount Antenna
Quad-Helix – Optimized Radiation Pattern
GPS/QZSS (L1), Galileo (E1) , GLONASS (G1), BeiDou (B1)
Wide Input Voltage Range
Dual-Stage LNA
IP67 Rated, Robust ASA Enclosure
Diameter 92.5mm, Height 120mm
Cable: 1m RG-174
Connector: SMA (M)
RoHS & Reach Compliant

1. Introduction	3
2. Specifications	4
3. Antenna Characteristics	7
4. Radiation Patterns	10
5. LNA Characteristics	14
6. Field Test Results	16
6. Mechanical Drawing	17
7. Packaging	18
8. Application Note	19
<hr/>	
Changelog	24

Taoglas makes no warranties based on the accuracy or completeness of the contents of this document and reserves the right to make changes to specifications and product descriptions at any time without notice. Taoglas reserves all rights to this document and the information contained herein. Reproduction, use or disclosure to third parties without express permission is strictly prohibited.



1. Introduction

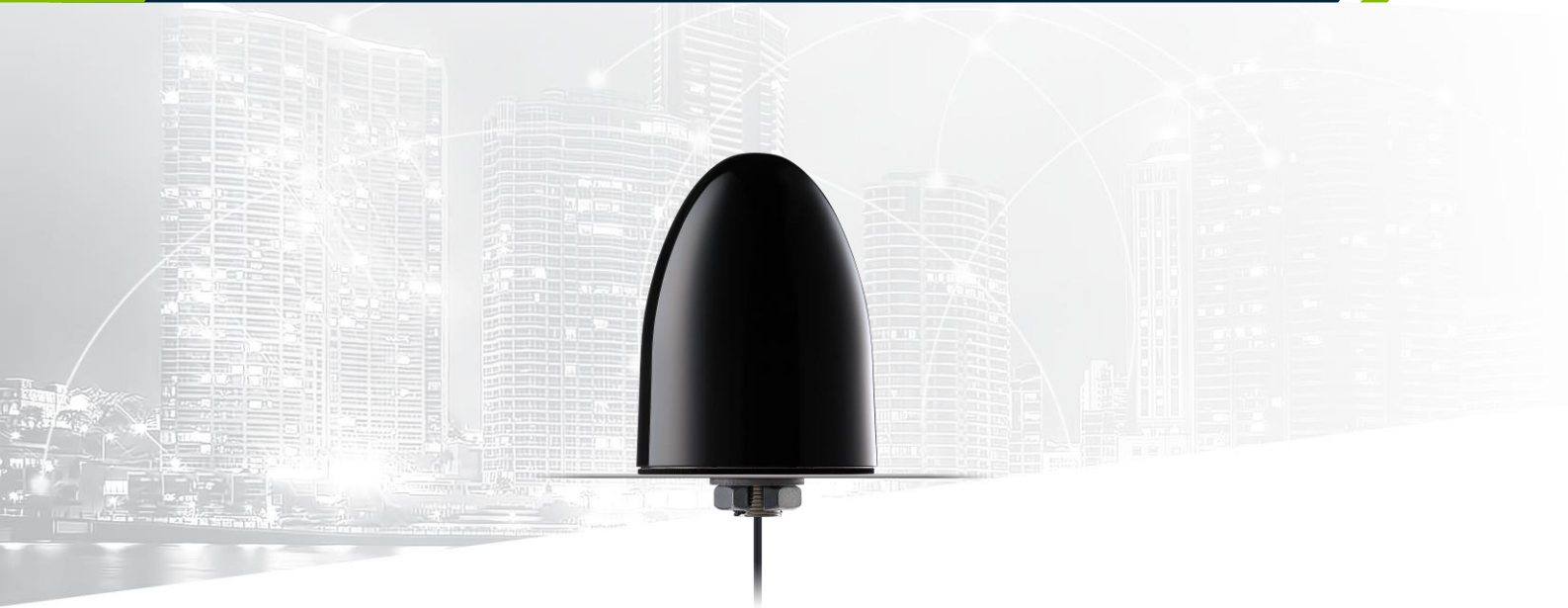

The Torpedo AQHA.11 GNSS quadrifilar helix antenna is a high-performance GNSS antenna for demanding GPS/GLONASS/BeiDou/GALILEO applications. The wide bandwidth allows maximum coverage of the main global satellite constellations. The wide axial ratio beamwidth of the quad-helix provides excellent reception and signal fidelity across the sky, reducing multipath effects while seeing more low elevation satellites, in comparison to patch antenna designs.

Typical Applications Include:

- Timing
- Precision Positioning for Robotics / Automotive
- Telematics
- Autonomous Routing

The AQHA.11 is provided with a dual-stage LNA combined front-end, which provides high rejection, low noise figure, and excellent gain. The amplifiers accept a wide input voltage range of 2 – 24V and requires low current (10mA typical).

The AQHA.11 is ready for outdoor industrial and commercial usage with full -40 to +85°C temperature rating and IP67 ingress protection rating of its ASA enclosure.

In RTK applications, when used on both the base and the rover, the AQHA.11 can achieve genuine centimeter-level accuracy. Please refer to the App Note on the AQHA.11 product page for more information.

Cable and connector are customizable, contact your regional Taoglas customer support team for further information.

2. Specifications

GNSS Frequency Bands Covered						
GPS	L1	L2	L5			
	■	□	□			
GLONASS	G1	G2	G3			
	■	□	□			
Galileo	E1	E5a	E5b	E6		
	■	□	□	□		
BeiDou	B1	B2a	B2b	B3		
	■	□	□	□		
QZSS (Regional)	L1	L2C	L5	L6		
	■	□	□	□		
IRNSS (Regional)	L5					
	□					
SBAS	L1/E1/B1	L5/B2a/E5a	G1	G2	G3	
	■	□	■	□	□	

*SBAS systems: WASS(L1/L5), EGNOS(E1/E5a), SDCM(G1/G2/G3), SNAS(B1,B2a), GAGAN(L1/L5), QZSS(L1/L5), KAZZ(L1/L5).

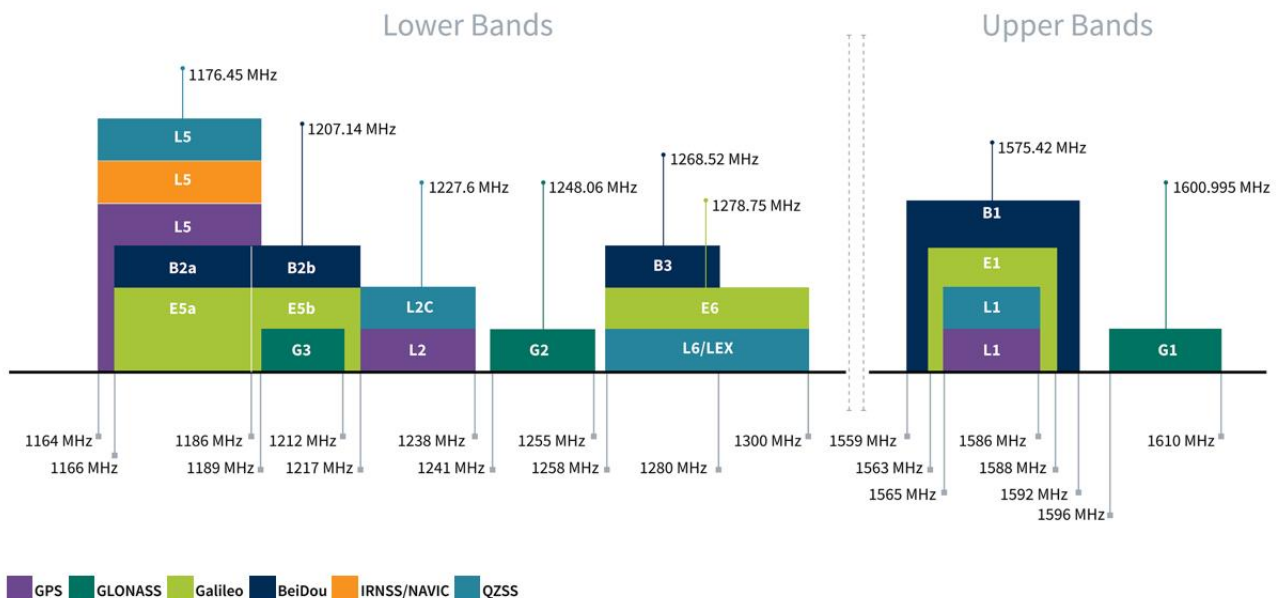

GNSS Bands and Constellations

Electrical			
Frequency	BeiDou 1561 MHz	GPS 1575.42 MHz	GLONASS 1601.6 MHz
Efficiency (%)	70%	70%	70%
Peak Gain (dBi)	+0.7	+1.0	+1.0
Group Delay	0.3	0.4	0.4
PCO (cm)	1.2	1.2	1.2
PCV (cm)	0.6	0.6	0.6
Axial Ratio	Zenith to 90° elevation: < 3dB		
Impedance	50 Ω		
Polarization	RHCP		

Mechanical	
Total Dimension	120*93Ø mm
Casing	ASA
Base and thread	Nickel Plated Zinc Alloy
Ingress Protection Rating	IP67
Maximum Assembly Torque	39.2 N·m
Weight	325 g
Cable/Connector	RG174 coaxial cable, length 1000mm, SMA(M)

LNA Gain, Power Consumption and Noise Figure			
Frequency	BeiDou 1561 MHz	GPS 1575.42 MHz	GLONASS 1601.6 MHz
Input Voltage 2 – 24V	LNA Gain	28 dB	28 dB
	Noise Figure	< 2.5 dB	< 2.0 dB
	In-band IP1dB	> -20 dBm	> -20 dBm
	Group Delay Variation	< 10 ns	< 10 ns
	Current	< 15mA	

Environmental	
Operation Temperature	-40°C to 85°C
Storage Temperature	-40°C to 85°C
Humidity	Non-condensing 65°C 95% RH
RoHS Compliant	Yes
REACH Compliant	Yes

3. Antenna Characteristics

3.1 Return Loss

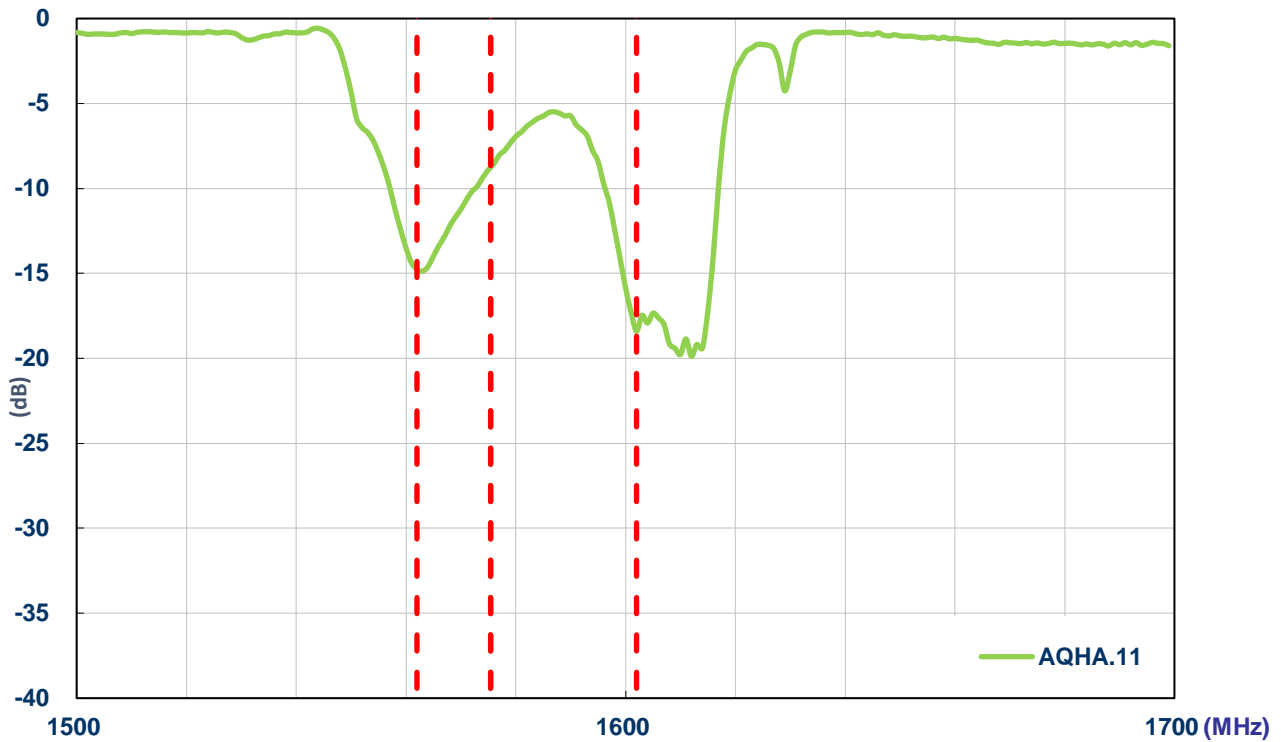

3.2 Efficiency

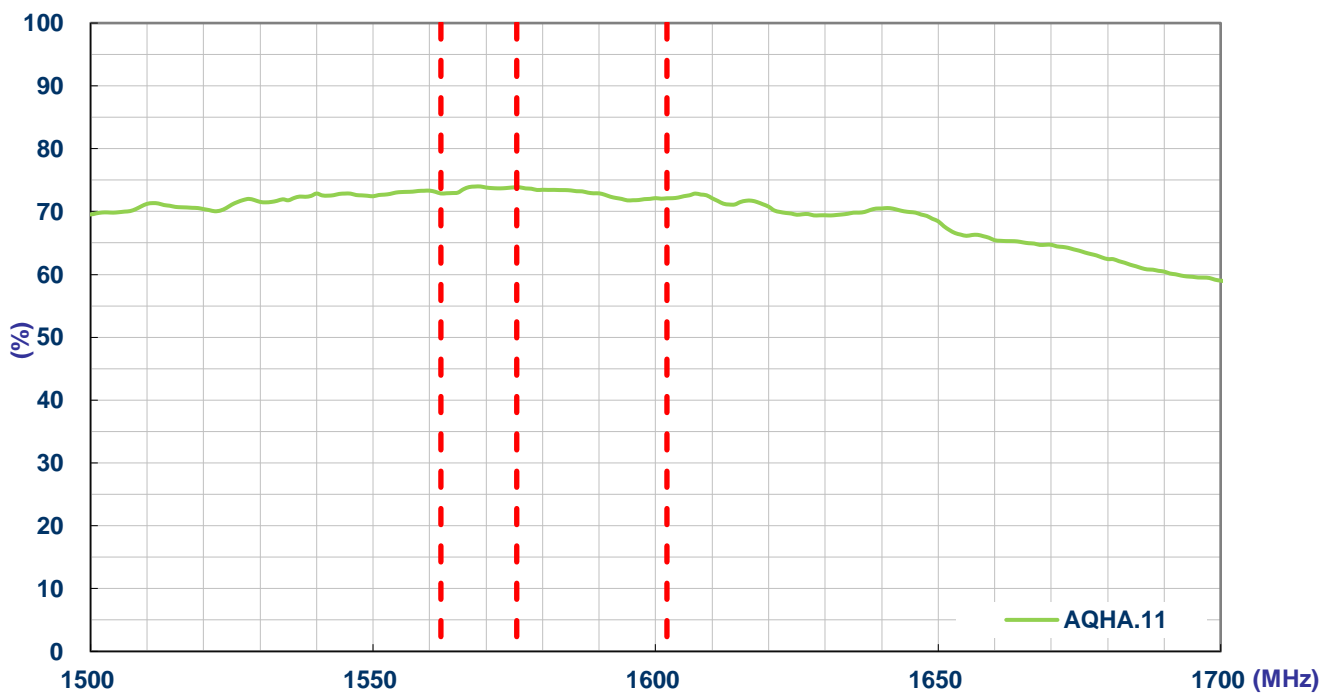

3.3 Average Gain

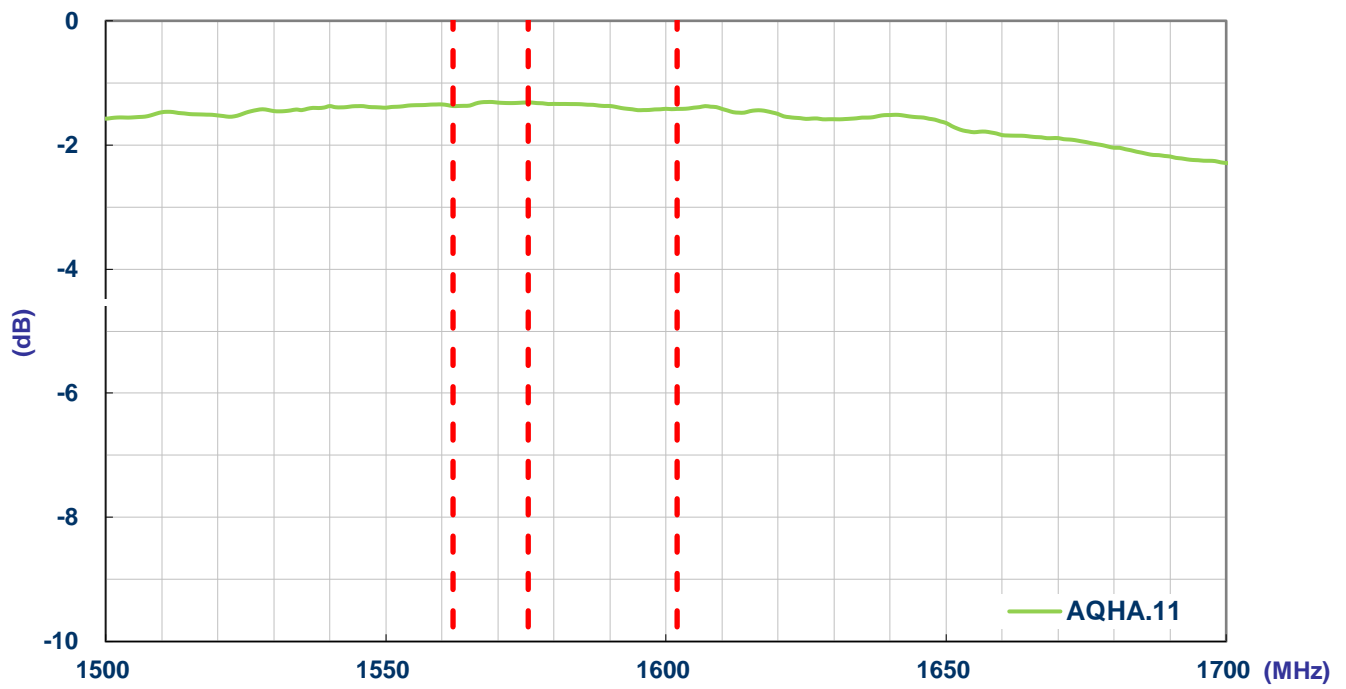

3.4 Peak Gain

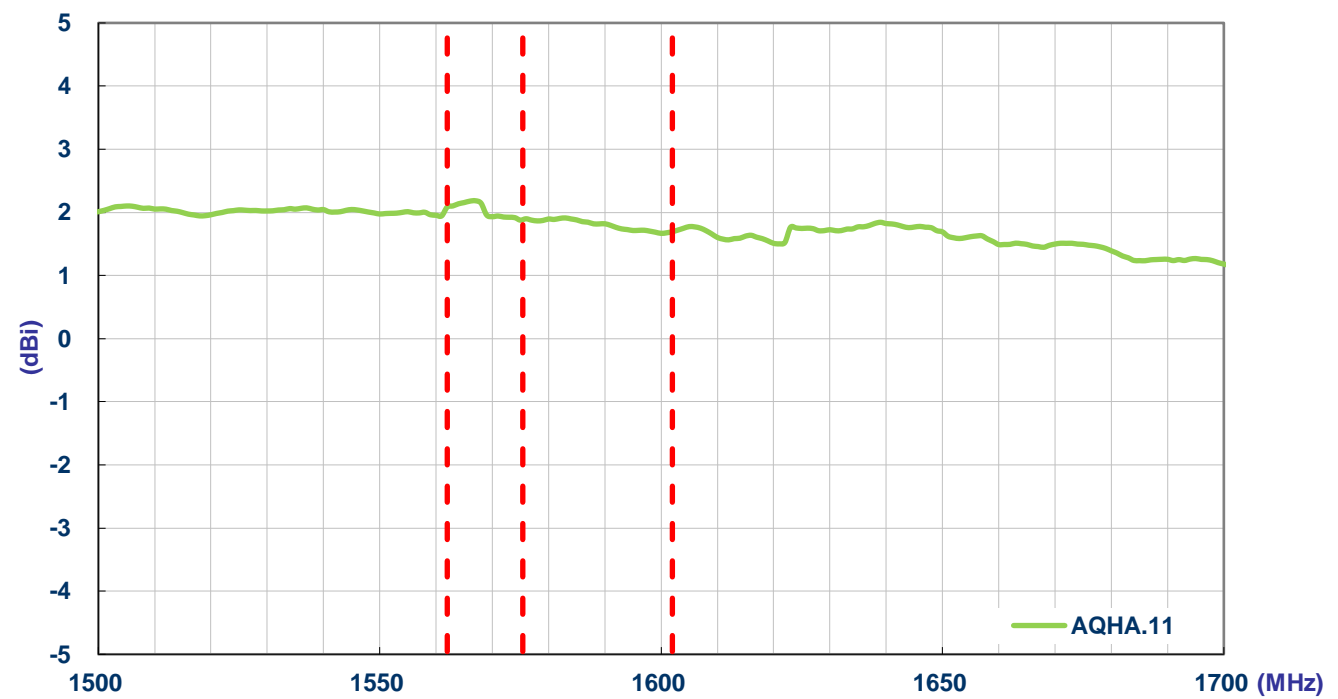

3.5 Axial Ratio @ 1575.42MHz - Phi=0

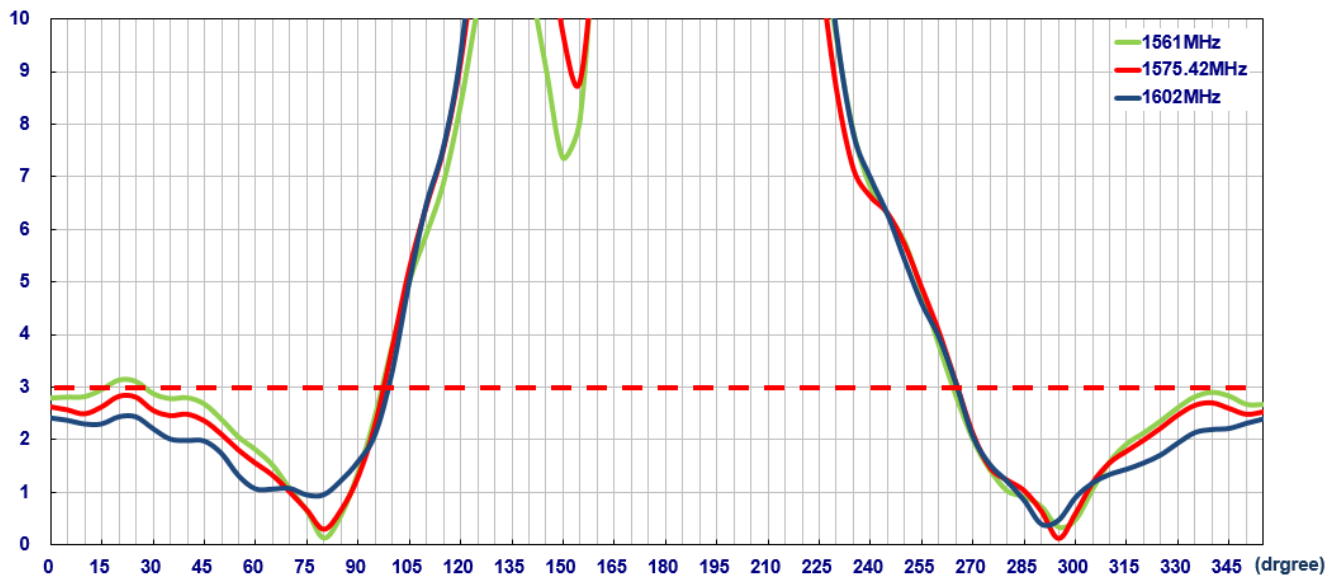

4. Radiation Patterns

4.1 Test Setup – Free Space

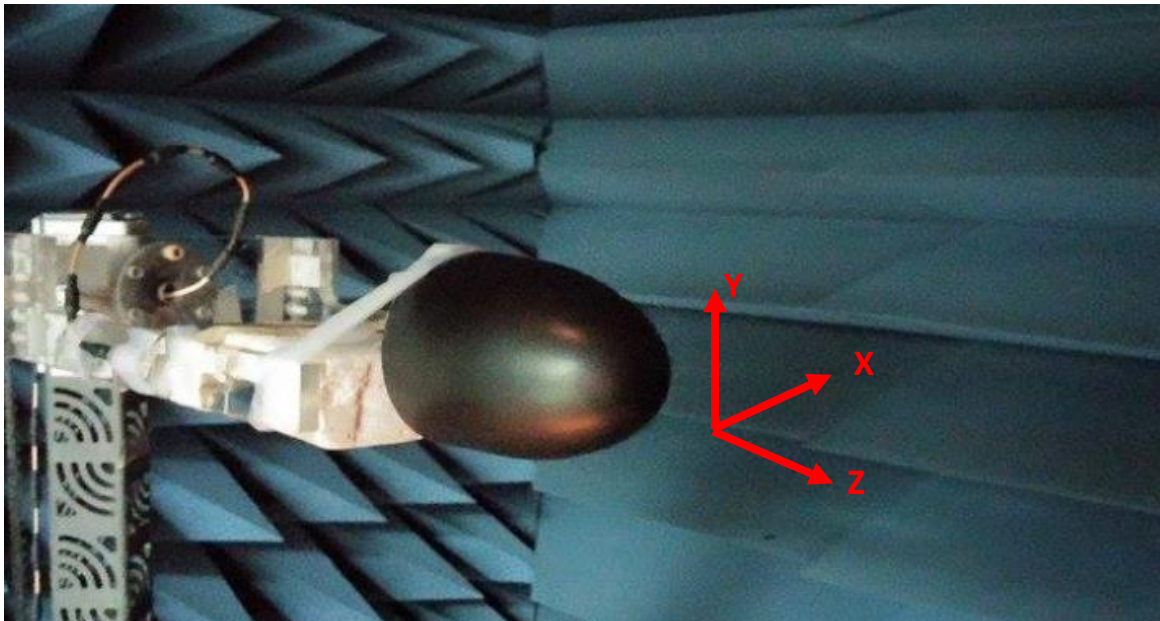

4.2 1561MHz 3D and 2D Radiation Patterns

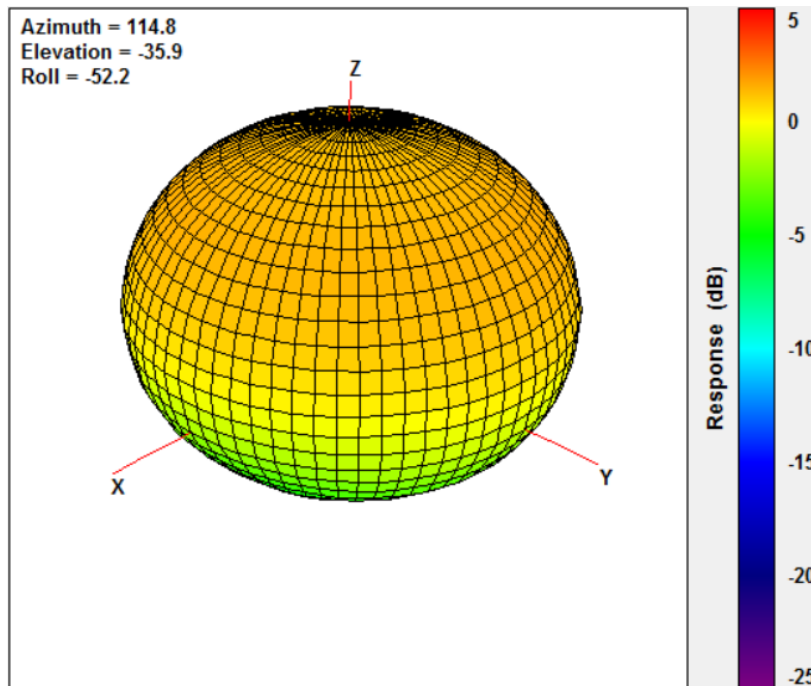

XY Plane

XZ Plane

YZ Plane

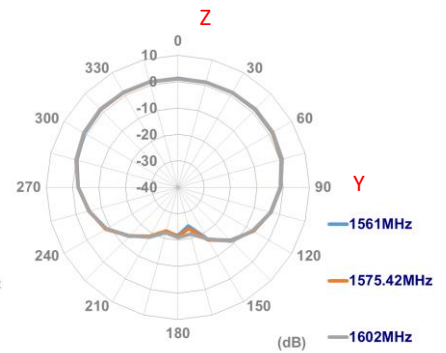
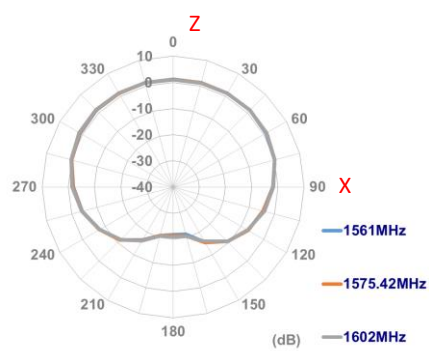
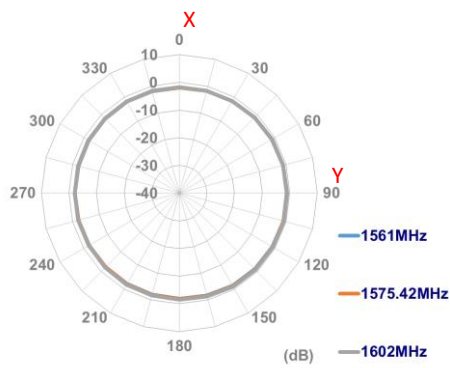

4.3 1575.42MHz 3D and 2D Radiation Patterns

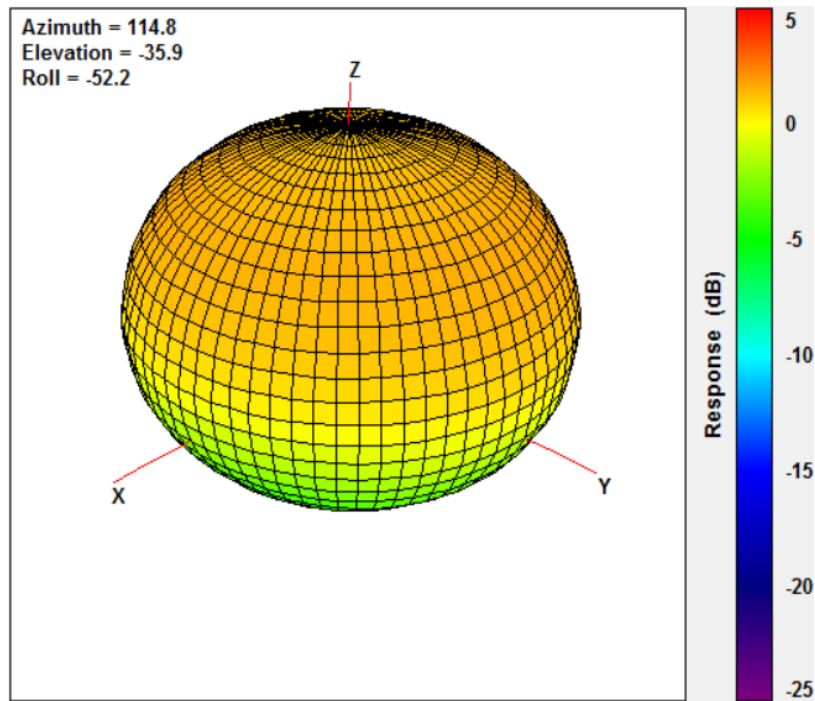

XY Plane

XZ Plane

YZ Plane

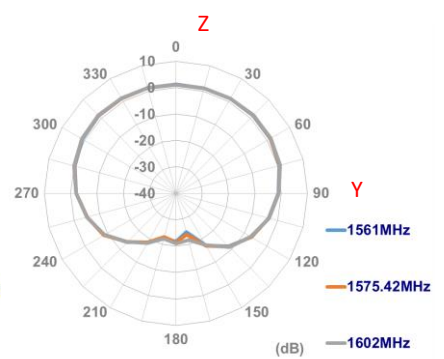
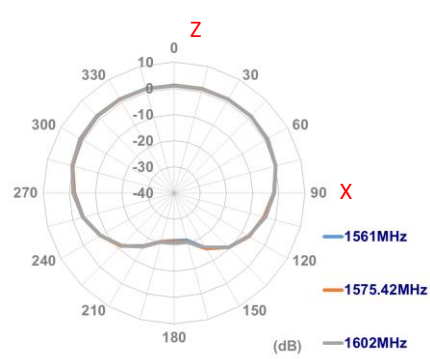
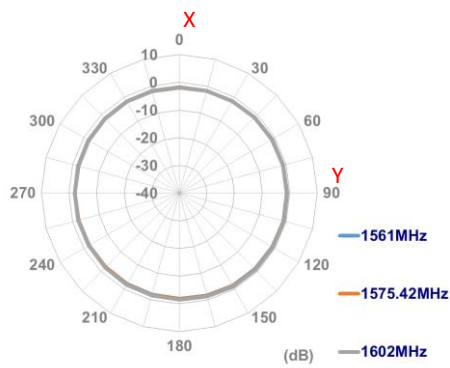

4.4 1602MHz 3D and 2D Radiation Patterns

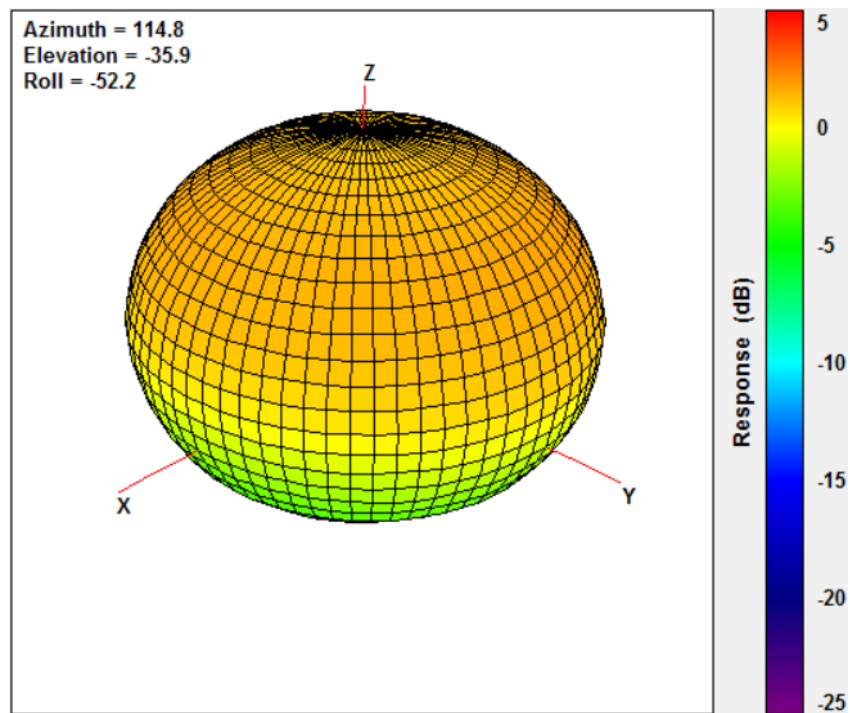

XY Plane

XZ Plane

YZ Plane

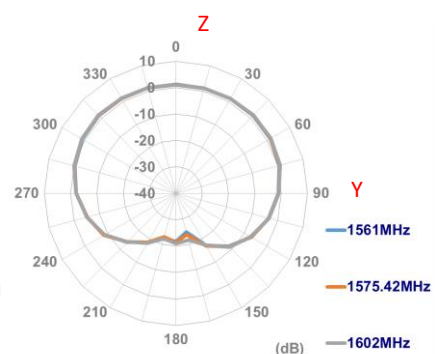
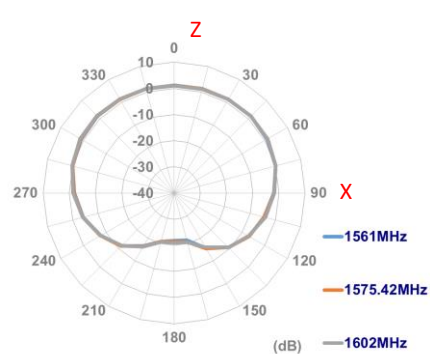
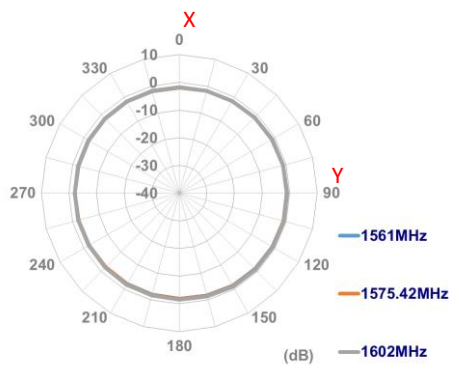

5. LNA Characteristics

5.1 Block Diagram (Active Antenna)

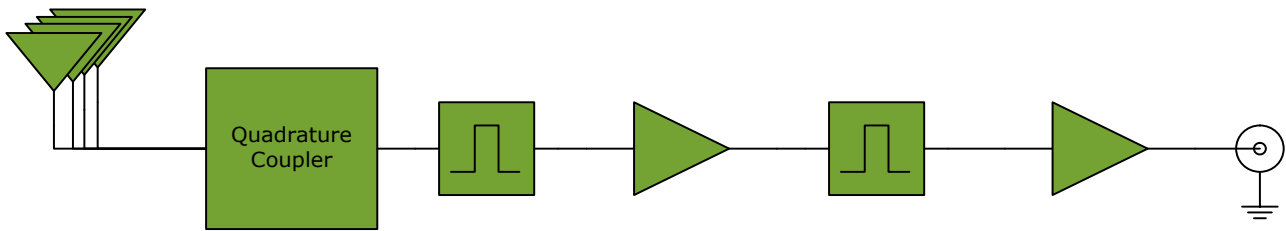

5.2 Wiband Return Loss

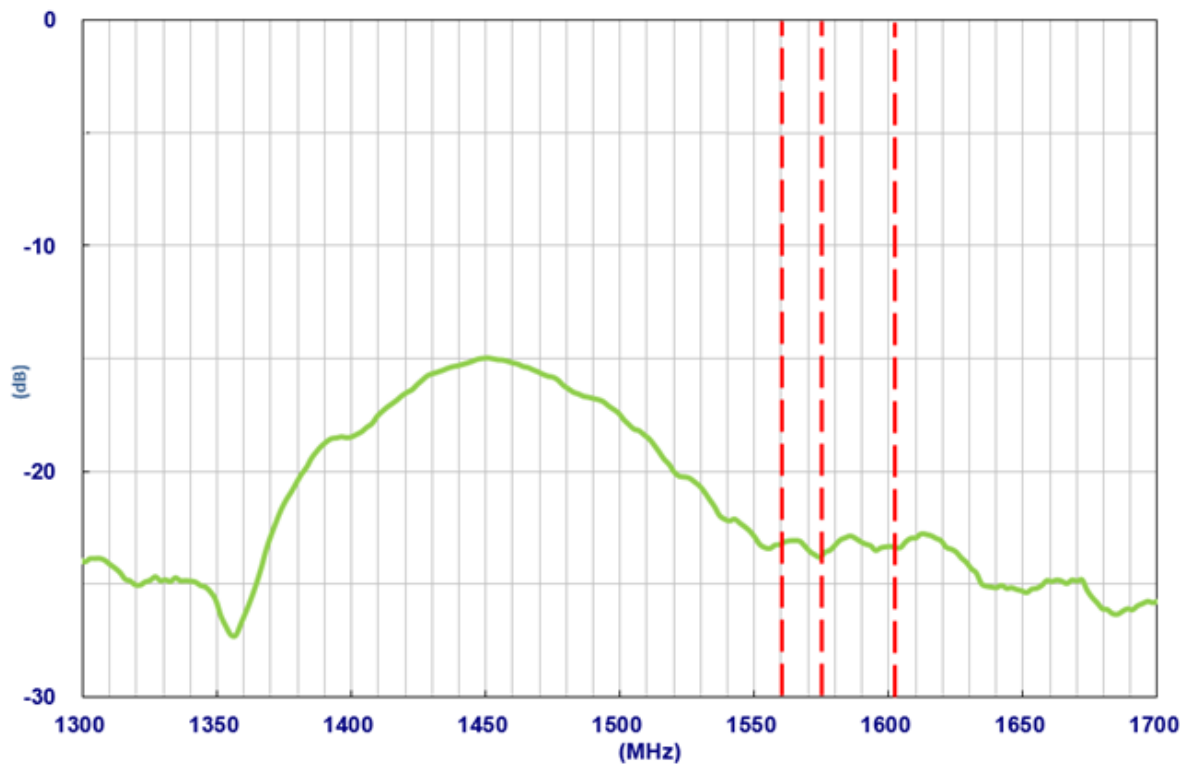

5.3 Out of Band Rejection

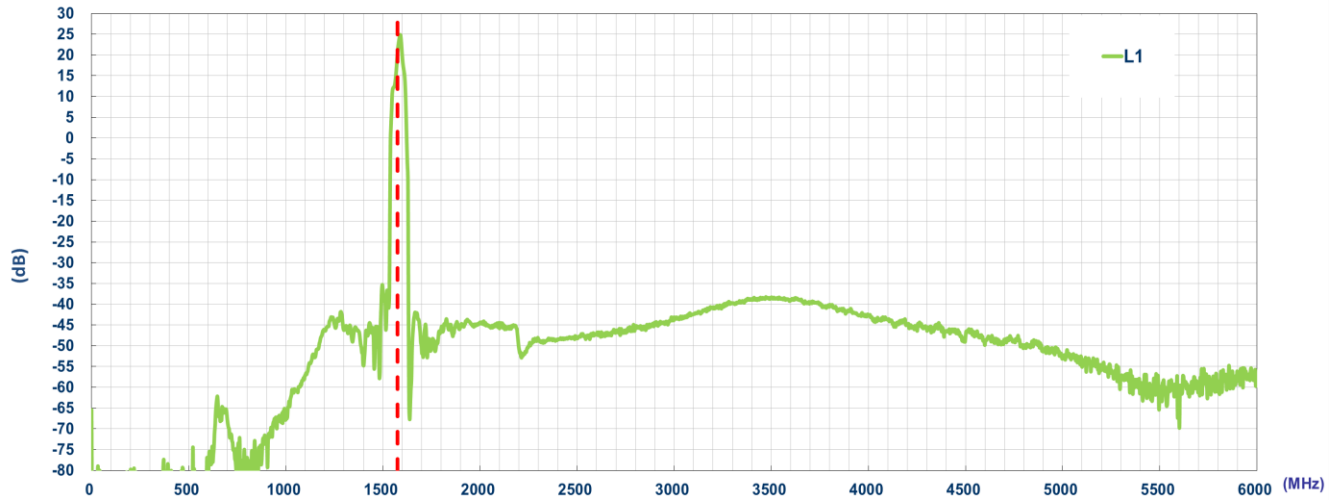

6. Field Test Results

6.1 Rooftop test

In this section Taoglas will present the field test result for AQHA.11 antenna. The test was performed when the antenna was mounted on a static rooftop test set up in an open sky environment for at least **6 hours**.

Taoglas will show the field test results using the following receiver:

1. U-blox ZED-F9P

Receiver features:

- Multi-band GNSS: 184-channel GPS L1C/A L2C, GLONASS: L1OF L2OF, Galileo: E1B/C E5b, BeiDou: B1I B2I, QZSS: L1C/A L2C
- Multi-band RTK with fast convergence times and reliable performance
- Nav. update rate RTK up to 20 Hz
- Position accuracy = RTK 0.01 m + 1 ppm CEP

Positioning Accuracy Table (2D Accuracy)					
Test Condition	Correction Service	CEP (50%)	DRMS (68%)	2DRMS (95-98.2%)	TTF (sec)
Free Space	RTK DISABLED	62.05 cm	80.39 cm	160.77 cm	30
	RTL ENABLED	1.03 cm	1.27 cm	2.54 cm	30
30x30 cm Ground Plane	RTK DISABLED	42.06 cm	50.53 cm	101.06 cm	25
	RTL ENABLED	0.95 cm	1.14 cm	2.28 cm	25

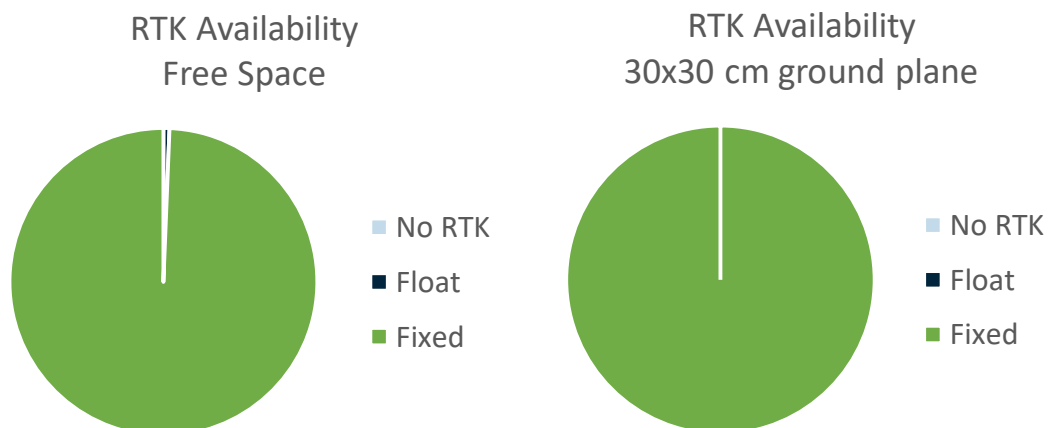

7. Mechanical Drawing (Units: mm)

6	5	4	3	2	1				
ISO NO: EDW-16-8-xxxx		<Release>		REV	ZONE	DESCRIPTION	ENG	APPROVED	ISSUED DATE
		<Release>		1	ALL	Initial Design	Haley	Wayne	2016/05/27
		<Release>		2	ALL	Change Part Number, Title & Cable Length	Haley	Wayne	2016/06/23

Name	P/N	Material	Finish	QTY
1 Housing	000116D040000A	ABS	Black/UV Coating	1
2 Mini ST Base	000314K000092A	Zinc Alloy	Ni Plated	1
3 Adhesive Foam Mini ST	001015C020000A	3M9448+CR4305	White Liner	1
4 Washer_Cut	000413E040061A	Steel	Ni-Zn Plated	1
5 Nut_M20x1.5Px10H Cut	000413E030061A	Steel	Ni-Zn Plated	1
6 Heat Shrink Tube	001315C020000A	PE	Black	1
7 Empty Label	001015G000000A	PET	White	1
8 Barcode Label	001015G010000A	PET	White	1
9 GPS-GLONASS-BEIDOU Label	001014E030051A	Coated Paper	Orange	1

Name	P/N	SPEC	Finish	QTY
XX Cable Type	301315C000000A	RG174	Black	1
YY Connector Type	200212G000013A	SMA(M)ST	Au Plated	1

UNLESS OTHERWISE SPECIFIED TOLERANCES ON: .X± 0.2 XX± 0.5 .XX± 0.1 X.± 0.3 .XXX± 0.05	DATE: 2016/05/27	MAT'L:	 <small>TW Design Centre This drawing and its inherent design concepts are property of Taoglas. Not to be copied or given to third parties without the written consent of Taoglas.</small>	REV
	UNIT: mm	FINISH:		D02
	THIRD ANGLE PROJECTION	SCALE: 1/2		TITLE: :Torpedo - Screwmount 1M RG-174 SMA(M) Active GPS/GLONASS/BEIDOU
	APPROVED BY: Wayne	CHECKED BY: Jack/Paul		DRAWN BY: Haley

8. Packaging

1 pc AQHA.11.A.101111 per PE bag
 Bag Dimensions - 180 x 215mm
 Weight - 338g

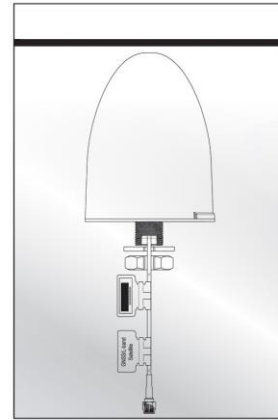

1 Outer Carton
 Carton Dimensions - 390 x 260x 350mm
 8 pcs AQHA.11.A.101111 per carton
 Weight - 3.5Kg

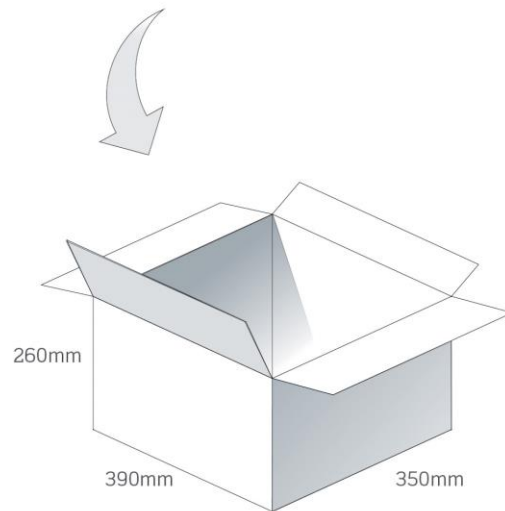

Pallet Dimensions 1200*1000*1250mm
 24 Cartons per Pallet
 3 Cartons per layer
 8 Layers

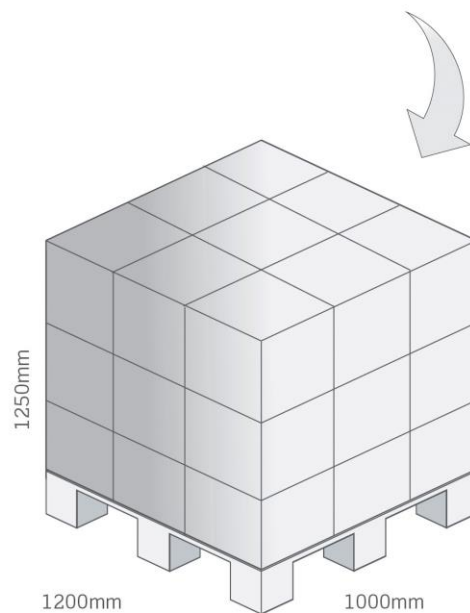

9. Application Note

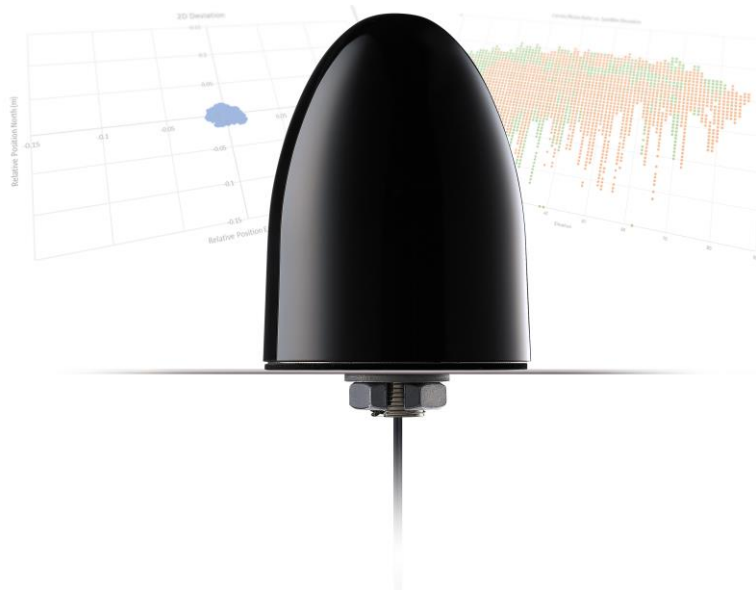

Introduction

Recent commercial developments in GNSS receivers have begun to make the dream of centimeter-level outdoor positioning a reality for certain applications. These receivers use Real-Time Kinematic (RTK) or Differential GNSS (DGNSS or DGPS) methods to reduce the impact on positioning accuracy of atmospheric and similar effects.

To fully realize the potential of these systems, a high-performance single-band Quadrifilar (Quad) Helix antenna has been developed by Taoglas. The AQHA.11 provides excellent phase and circular polarization stability across frequency and space. These traits provide excellent multi-path rejection and phase center stability.

To demonstrate this potential, a DGNSS system was constructed using standard commercial off-the-shelf (COTS) receivers. The results are presented in this application note.

The system was constructed around a pair of u-blox NEO-M8P boards from the [C94-M8P](#) evaluation kit (Figure 1).



Figure 1 u-blox C94-M8P evaluation board (courtesy u-blox)

These boards were configured as a DGNS system, with one acting as a base station and the other as a rover. As is typical in this type of setup, the base station generates correction data and sends it to the rover. The distance between the base station and rover (the baseline) was kept short (< 2m) to minimize baseline effects. A Taoglas AQHA.11 was used as the base station antenna for all tests.

The base station was configured as an NTRIP server and provided RTCM v3.2 correction data. The rover used an NTRIP client to receive the RTCM data. Like the hardware, COTS software (u-blox u-center) was used for all data gathering and DGNS operation. See the block diagram in Figure .

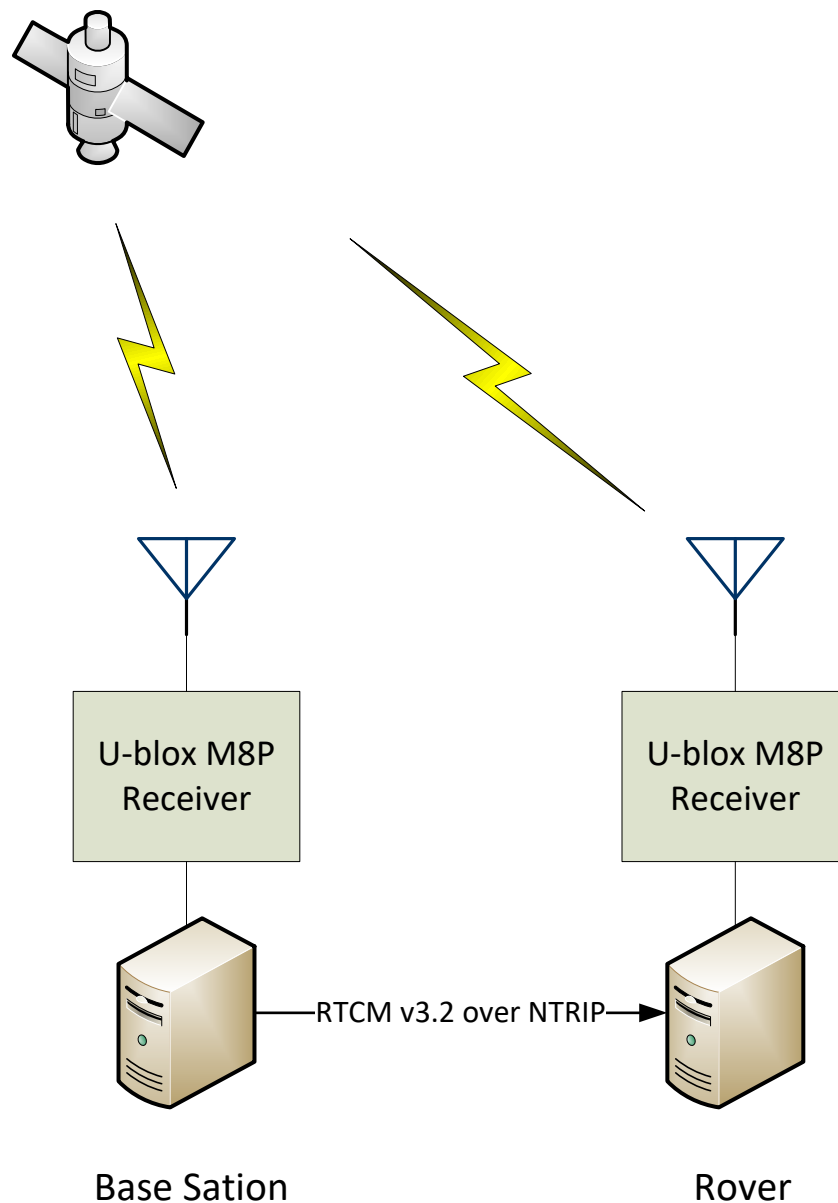

Figure 2 System configuration

To minimize the effects of satellite availability, the evaluation times were constricted to the 0000 – 0600 UTC time frame. Since the GPS constellation is periodical with a 24h period, this meant the same GPS satellites were available.

Some data points were removed during the evaluation to remove erroneous outliers. These points were:

- Data points with fewer than 5 satellites available
- Data points without DGPS in use
- Data points without a valid fix
- Data points without a relative position

More than 7 satellites were available for all evaluation times. Dilution of Precision (DOP) metrics were not restricted or constrained during this evaluation.

The rover receiver generated a relative position to the base station. This data was used for the analyses below.

From the resulting 6 hours of data (around 20k data points), the following was calculated:

- Average 2D relative position using the North/East coordinate system
- Deviation of all relative positions from the average
- Standard deviation of North, East, and 2D deviations

Test Setup

AQHA.11 as Base Station Antenna

FXP611 as Rover

The Taoglas FXP611 Cloud is a high-efficiency flexible circuit GNSS antenna. It features wide bandwidth and light weight, making it an excellent option for weight-sensitive applications.



Figure 3 Taoglas FXP611

The position deviation data points for the FXP611 are plotted in Figure .

2D Deviation Map

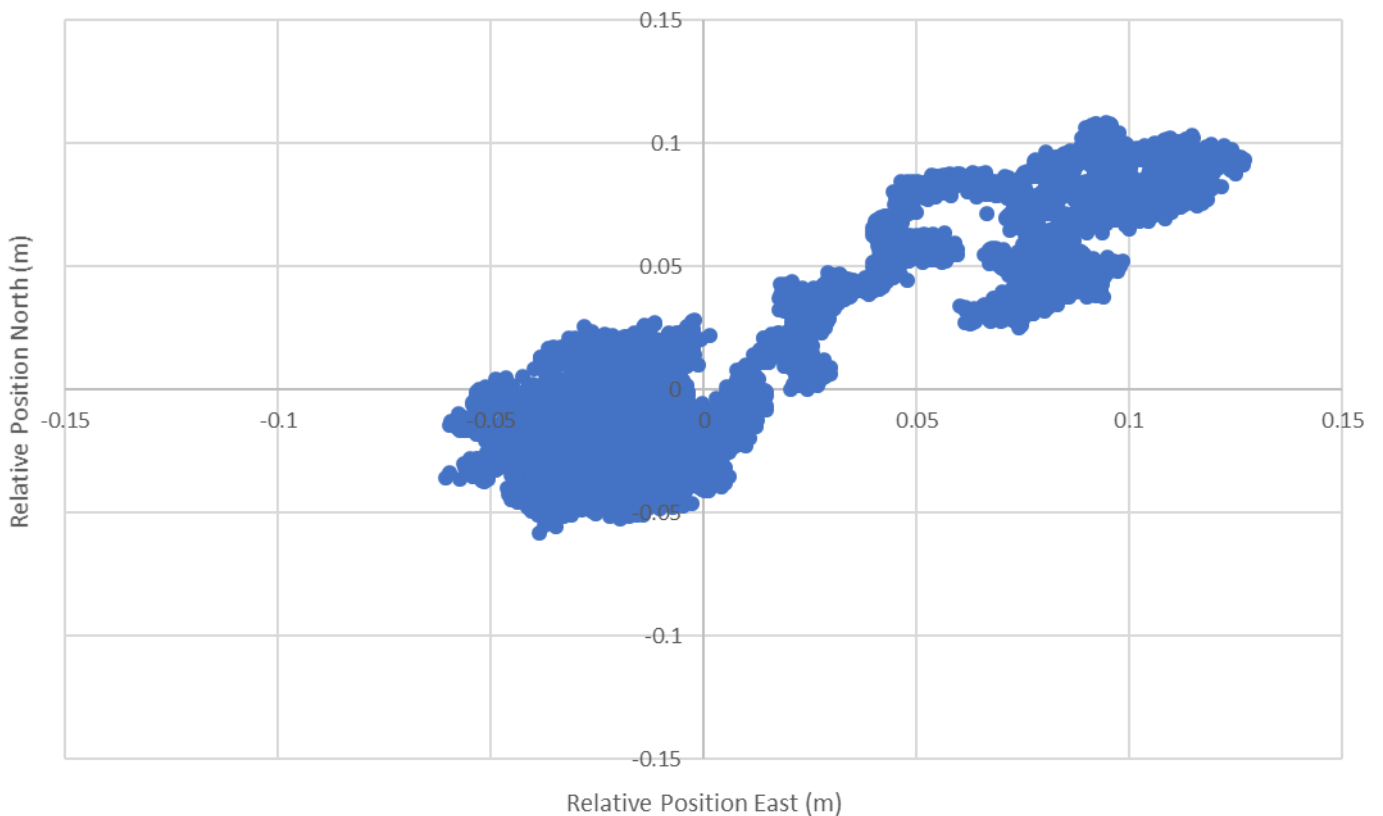

Figure 4 Relative position deviation map, FXP611 as rover

AQHA.11 as Rover

The AQHA.11 is a high-performance GNSS Quadrifilar Helix Antenna (QHA) supporting GPS L1, BeiDou B1, and GLONASS G1. The AQHA.11 features wide bandwidth, wide gain and axial ratio beam width, and excellent phase stability. The AQHA.11 provides an excellent choice for high-stability single-band GNSS positioning and timing applications.



Figure 5 AQHA.11 Quad Helix Antenna

The position deviation data points for the AQHA.11 are plotted in Figure .

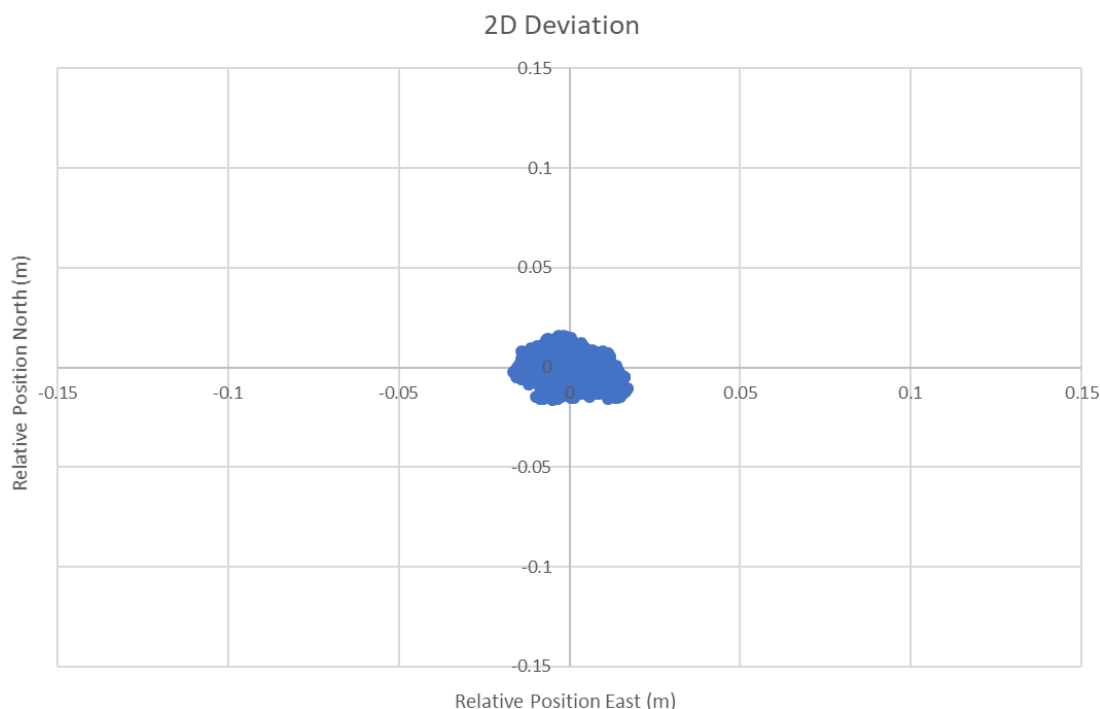

Figure 6 Relative position deviation map, AQHA.11 as rover

Results Summary

Error! Reference source not found. provides a comparison summary of the results from Sections 0 and 0. A primary focus is on the Standard Deviation (SD) of the deviation map. A larger SD depicts a wider spread of positioning across the map showing a variable rate of accuracy. With the AQHA.11 however, we are clearly seeing a tighter cluster of deviation data points indicating a much higher level of positioning accuracy. Additionally, we are seeing similar metrics between the North and East indicating little or no pattern or phase bias. What we have with the AQHA.11 is a more circular pattern, indicating that the fix is highly stable and reliable by comparison to anything in the marketplace.

Metric	FXP611	AQHA.11
SD, North	3.8 cm	0.4 cm
SD, East	4.2 cm	0.5 cm
SD, 2D	3.2 cm	0.5 cm
Max-Min, North	16 cm	3.2 cm
Max-Min, East	18 cm	3.3 cm

Table 1 Comparison Summary

Conclusion

With modern GNSS receivers, it is possible to create a decimeter or centimeter level positioning system. A lightweight, compact antenna such as the FXP611 can be used and still benefit from RTK or DGPS techniques to provide decimeter-level positioning.

A high-performance antenna such as the AQHA.11, by contrast, can bring centimeter-level positioning and timing solutions to a whole new level for a wide variety of applications such as Autonomous Driving, Augmented Reality, Remote Monitoring and Connected Health to name a few that will deploy centimeter level accuracy.

Changelog for the datasheet

SPE-17-8-072 – AQHA.11.A.101111

Revision: D (Current Version)

Date:	2020-06-02
Changes:	Added Field Test Results
Changes Made by:	Victor Pinazo

Previous Revisions

Revision: C

Date:	2020-02-17
Changes:	Updated Template
Changes Made by:	Jack Conroy

Revision: B

Date:	2020-01-16
Changes:	Adding in the Base Station/Rover configuration data
Changes Made by:	David Connolly

Revision: A (Original First Release)

Date:	2017-09-20
Notes:	Initial Datasheet Release
Author:	Jack Conroy



TAOGLAS®

www.taoglas.com



Компания «Океан Электроники» предлагает заключение долгосрочных отношений при поставках импортных электронных компонентов на взаимовыгодных условиях!

Наши преимущества:

- Поставка оригинальных импортных электронных компонентов напрямую с производств Америки, Европы и Азии, а так же с крупнейших складов мира;
- Широкая линейка поставок активных и пассивных импортных электронных компонентов (более 30 млн. наименований);
- Поставка сложных, дефицитных, либо снятых с производства позиций;
- Оперативные сроки поставки под заказ (от 5 рабочих дней);
- Экспресс доставка в любую точку России;
- Помощь Конструкторского Отдела и консультации квалифицированных инженеров;
- Техническая поддержка проекта, помощь в подборе аналогов, поставка прототипов;
- Поставка электронных компонентов под контролем ВП;
- Система менеджмента качества сертифицирована по Международному стандарту ISO 9001;
- При необходимости вся продукция военного и аэрокосмического назначения проходит испытания и сертификацию в лаборатории (по согласованию с заказчиком);
- Поставка специализированных компонентов военного и аэрокосмического уровня качества (Xilinx, Altera, Analog Devices, Intersil, Interpoint, Microsemi, Actel, Aeroflex, Peregrine, VPT, Syfer, Eurofarad, Texas Instruments, MS Kennedy, Miteq, Cobham, E2V, MA-COM, Hittite, Mini-Circuits, General Dynamics и др.);

Компания «Океан Электроники» является официальным дистрибьютором и эксклюзивным представителем в России одного из крупнейших производителей разъемов военного и аэрокосмического назначения «JONHON», а так же официальным дистрибьютором и эксклюзивным представителем в России производителя высокотехнологичных и надежных решений для передачи СВЧ сигналов «FORSTAR».



JONHON

«JONHON» (основан в 1970 г.)

Разъемы специального, военного и аэрокосмического назначения:

(Применяются в военной, авиационной, аэрокосмической, морской, железнодорожной, горно- и нефтедобывающей отраслях промышленности)

«FORSTAR» (основан в 1998 г.)

ВЧ соединители, коаксиальные кабели, кабельные сборки и микроволновые компоненты:

(Применяются в телекоммуникациях гражданского и специального назначения, в средствах связи, РЛС, а так же военной, авиационной и аэрокосмической отраслях промышленности).



Телефон: 8 (812) 309-75-97 (многоканальный)

Факс: 8 (812) 320-03-32

Электронная почта: ocean@oceanchips.ru

Web: <http://oceanchips.ru/>

Адрес: 198099, г. Санкт-Петербург, ул. Калинина, д. 2, корп. 4, лит. А