

## Single Row Terminal Blocks

# A3, LP3 & CB3

### Dimensions Inches (Millimeters)

#### A3 & LP3



A31930307

LP307102

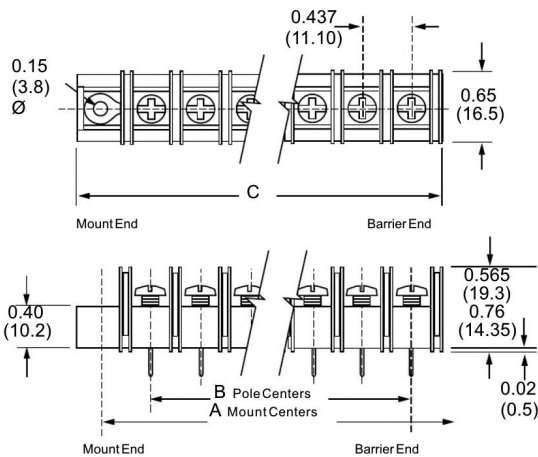

#### CB3

CB35110407MP

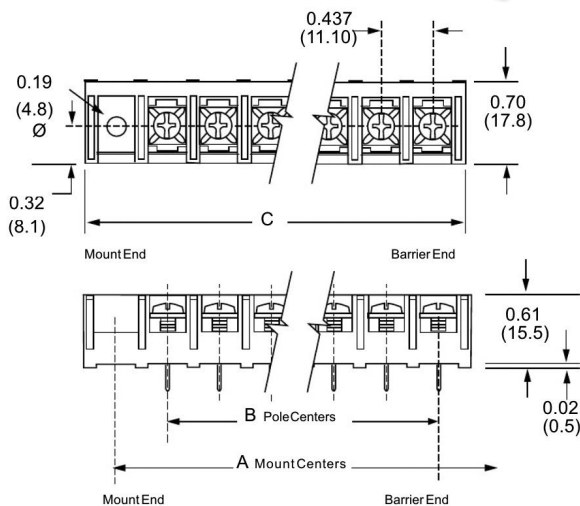

### Specifications

**Rating:** A3: 30A, 600V\* LP3: 30A, 150V\* CB3: 30A, 600V\*

**Wire Range:** #12-22 AWG Cu

**Center Spacing:** 0.437" or 7/16" (11.10mm)

**Screw Size:** #6-32 zinc-plated phillslot screws.

**Torque Rating:** 9 lb-in.

**Base:** Standoffs standard for easy flux washing.

**Distance Between Barriers:** 0.32" (8.1mm)

**Recommended PCB Hole Diameter:** 0.076" (1.93mm)

**Operating Temperature:** 105°C (221°F) max., -40°C (-40°F) min.

**Molded Material:** Black, UL Rated 94V0 Thermoplastic

**Breakdown Voltage:** 3500V (A3 & LP3); 8200V (CB3)

**Agency Information:** UL File E62622, CSA 47235; IEC Compliance, CE Certified

\* 30A Rating achieved with a #10 copper wire crimped to a ring terminal; 20 Rating without ring terminal.

Poles	MOUNTING ENDS ONLY		BARRIER & MOUNTING ENDS	
	A Mounting Ctrs.	C Length	B Pole Ctrs.	C Length
02	1.31	1.73	0.43	0.98
03	1.75	2.17	0.87	1.43
04	2.18	2.61	1.31	1.87
05	2.62	3.05	1.75	2.31
06	3.06	3.48	2.18	2.75
07	3.50	3.92	2.62	3.18
08	3.93	4.36	3.06	3.62
09	4.37	4.80	3.50	4.06
10	4.81	5.23	3.93	4.50
11	5.25	5.67	4.37	4.93
12	5.68	6.11	4.81	5.37
13	6.12	6.55	5.25	5.81
14	6.56	6.98	5.68	6.25
15	7.00	7.42	6.12	6.68
16	7.43	7.86	6.56	7.12
17	7.87	8.30	7.00	7.56
18	8.31	8.73	7.43	8.00
19	8.75	9.17	7.87	8.43
20	9.18	9.60	8.31	8.87
21	9.62	10.05	8.50	9.31
22	10.06	10.48	9.18	9.75
23	10.50	10.92	9.62	10.18
24	10.93	11.36	10.06	10.62
25	11.37	11.80	10.50	11.06
26	11.81	12.23	10.98	11.50
27	-	-	11.81	12.37
28	-	-	11.37	11.07



Powering Business Worldwide

## Part Numbering System

Family	Terminal Style	Base/End	Poles	Screw Options	Options
<b>A</b> <b>3</b>					
<b>A3</b> - standard barrier	<b>01</b> - handwired <b>02</b> - printed circuit <b>03</b> - non feed-thru <b>04</b> - wire wrap tail <b>05</b> - extended handwired <b>07</b> - extended pin <b>09</b> - 0.250 QC short <b>10</b> - 0.187 QC <b>19</b> - 0.250 QC long	<b>1</b> - std. base/mount end <b>2</b> - std. base/barrier <b>3*</b> - insulator base/mount end <b>4*</b> - insulator base/barrier end <b>5**</b> - closed base/mount end	<b>02 to 28</b> barrier end <b>02 to 26</b> mount end	Blank-std. screws <b>03</b> - stainless steel <b>04</b> - brass nickel-plated <b>07</b> - steel SEMS zinc-plated*** <b>09</b> - brass SEMS nickel-plated*** <b>07WR</b> - steel SEMS wire ready <b>CA†</b> - captive screw	<b>AB</b> - angle mnt. options (pg 18) <b>A1 to A9</b> - 0.250" QC <b>B1 to B9</b> - 0.187" QC <b>L1 to L6</b> marking options (pg 25) <b>MP, MT</b> - mounting plates (pg 18) <b>RC</b> - retaining clips (pg 18) <b>R30 to R66</b> - right angle bends (pg 18)

\* Base/End Styles 3 and 4 not available with 02, 03, and 09 terminals.

\*\* Base/End Note: 5 Style only available with 03 terminals.

\*\*\* SEMS screws not available with hardware options

† Not compatible with 03 stainless steel screw option.

## Terminal Styles Inches (Millimeters)

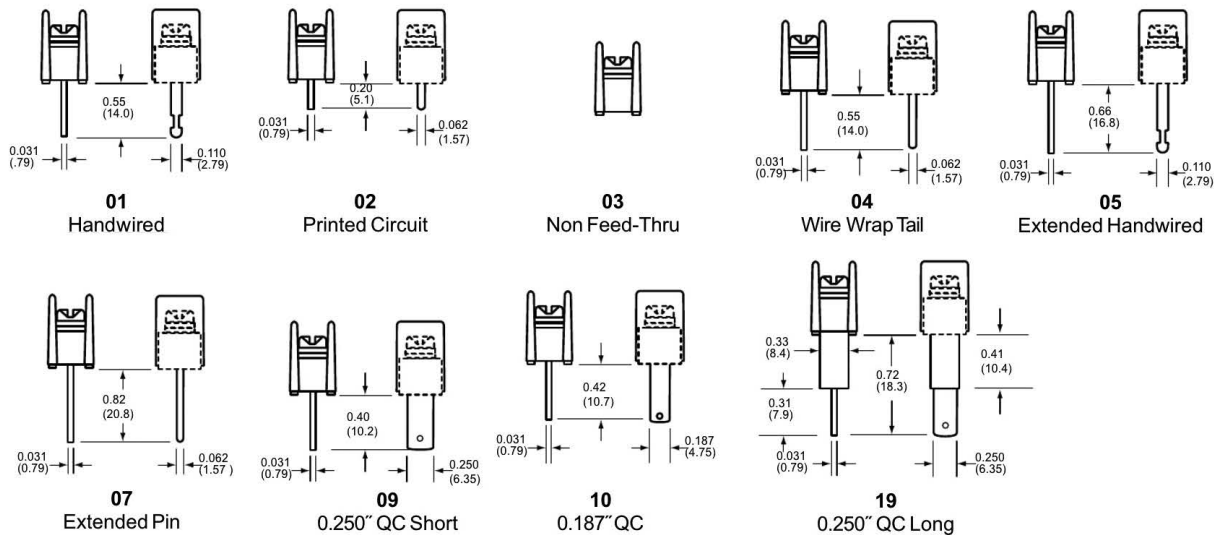



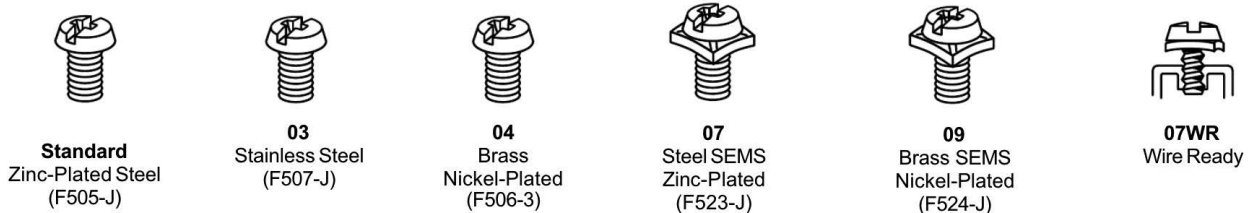

## Screw Options

(Bulk ordering part numbers are in parentheses)

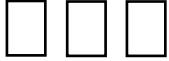

## Part Numbering System

Family	Terminal Style	Base/End	Poles	Screw Options	Options
 <p><b>LP3</b> - low profile barrier</p>	 <p><b>01</b> - handwired  <b>02</b> - printed circuit  <b>03</b> - non feed-thru  <b>04</b> - wire wrap tail  <b>05</b> - extended handwired  <b>07</b> - extended pin</p>	 <p><b>1</b> - std. base/ mount end  <b>2</b> - std. base/ barrier  <b>3*</b> - insulator base/mount end  <b>4*</b> - insulator base/barrier end  <b>5**</b> - closed base/mount end</p>	 <p><b>02 to 28</b> barrier end  <b>02 to 26</b> on mount end</p>	 <p>Blank-std. screws  <b>00</b> - screws shipped  <b>04</b> - brass nickel-plated  <b>07</b> - steel SEMS zinc- plated***  <b>CA</b> - captive screw</p>	 <p><b>A1 to A9</b> - 0.250" QC  <b>B1 to B9</b> - 0.187" QC  <b>L1 to L6</b> marking options (pg 25)  <b>MP</b> - mounting plates (pg 18)  <b>R30 to R66</b> - right angle bends (pg 18)</p>

\* A2 only.  
 \*\* Not compatible with 03-stainless steel screws.  
 \*\*\* SEMS screws not available with hardware options

## Terminal Styles Inches (Millimeters)

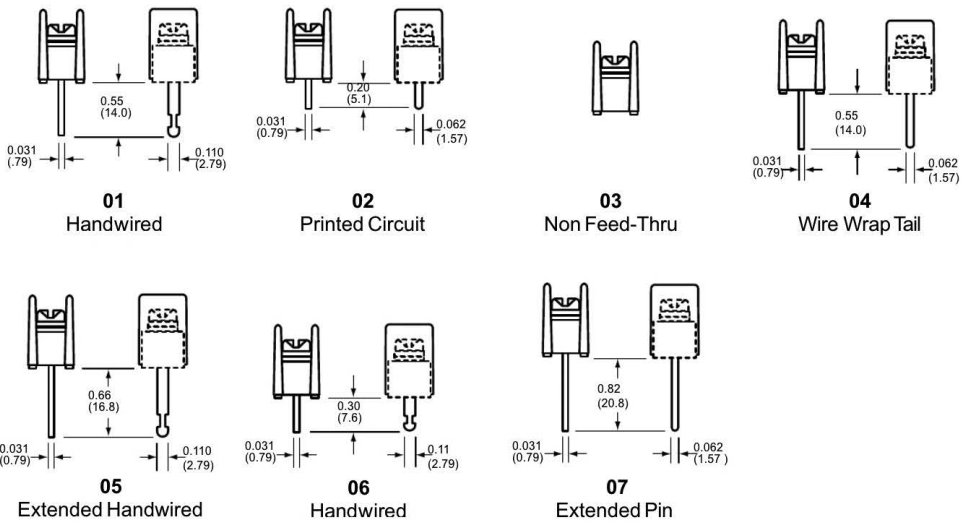

## Screw Options

(Bulk ordering part numbers are in parentheses)

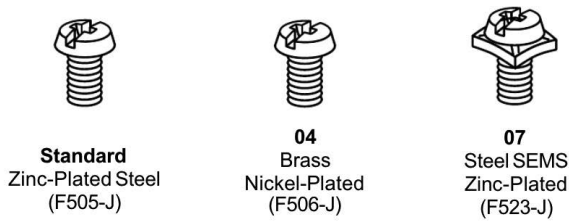

**Hardware Options** Inches (Millimeters)

(Bulk ordering part numbers are in parentheses)

**Jumpers**



†J201  
Flatslip-on  
(J201-J)



†OJ3  
(OJ3-J)



†OJ7  
LP3 Only  
(OJ7-J)



†OJ5  
(OJ5-J)

† Contact Eaton for desired configuration.

**Quick Connects** Blade Width A = 0.250" Blade Width B = 0.187"

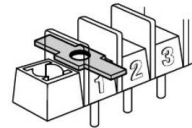

A1 & B1  
(2A1-J & 2B1-J)



A2 & B2  
(2A2-J & 2B2-J)

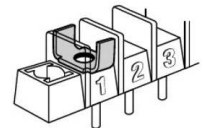

A3 & B3  
(2A3-J & 2B3-J)

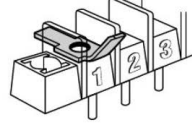

A4 & B4  
(2A4-J & 2B4-J)

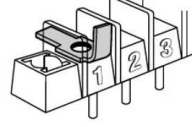

A5 & B5  
(2A5-J & 2B5-J)

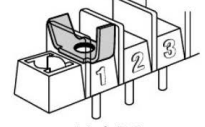

A6 & B6  
(2A6-J & 2B6-J)

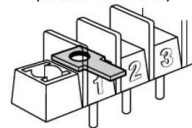

A7 & B7  
(2A7-J & 2B7-J)

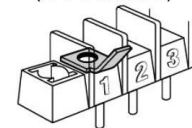

A8 & B8  
(2A8-J & 2B8-J)

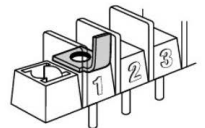

A9 & B9  
(2A9-J & 2B9-J)

**Base/End Options** Inches (Millimeters)



1 - Standard base/mount end



2 - Standard base/barrier end



3 - Insulator base/mount end

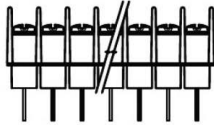
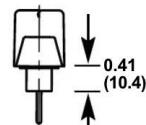

4 - Insulator base/barrier end

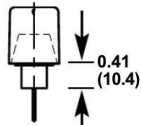

5 - Closed base/mount end



**Mount End Details**

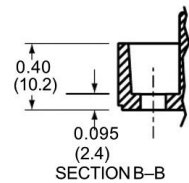
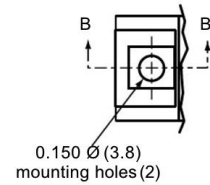

**1, 3 & 5 Mount End**

Note: On 1, 3 and 5 bases, Eaton may drill a terminal spacing to be a mount end. There will be no fit/form/function effect of mounting the product

**Mounting Options** Inches (Millimeters)

**Right Angle Mounting Bracket**

Right angle terminals are offered on the A3 & LP3. Configurations are defined in these dimensions: X = pin extension beyond the block base; Z = length from block base to centerline of the terminal tip. Standard bends consist of the X and Z dimensions shown in the chart. Specify by adding the selected Bend Option Code to the terminal part number.

**04 Terminal Bend Configurations**

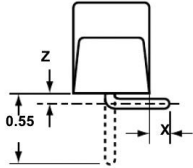

Bend Option Code	X (minimum)	Z	Available w/insulator base
R36	0.02	0.22	No
R42	0.08	0.16	No
R46	0.12	0.12	No
R50	0.16	0.08	No

Dimensions in inches. To convert to millimeters, multiply by 25.4.

**07 Terminal Bend Configurations**

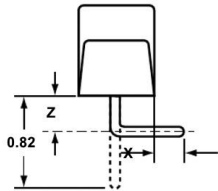

Bend Option Code	X (minimum)	Z	Available w/insulator base
R36	0.02	0.49	Yes
R50	0.16	0.35	No
R66	0.32	0.19	No

Dimensions in inches. To convert to millimeters, multiply by 25.4.

**Angle Brackets (A3 only)**

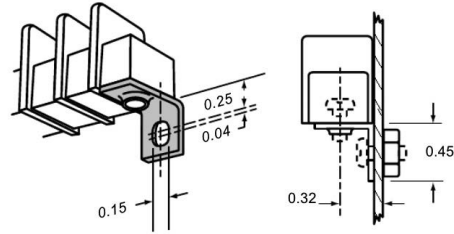

**Option AB**

Angle brackets enable block to be fastened at right angles to normal mount position. Bulk part number **2AB-J**.

**Mounting Plates**

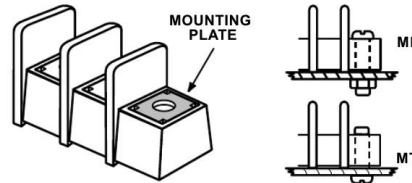

**Options MP & MT**

**MP** Metal inserts with 0.150" dia. hole accept #6 screw.

**MT** Metal inserts with tapped hole accept #6-32 screw.

Bulk part number **2MP-J, 2MT-J**.

**Retaining Clip**

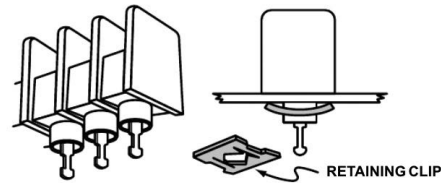

**Options RC**

Use on standoff tubes. Fit panels up to 0.125" thick. Two clips for every five positions. Supplied unassembled. Bulk part number **H541-J**.

## Part Numbering System

### Family



**CB3** - closed back

### Terminal Style

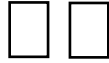

**01** - handwired  
#6-32 screw

**02** - printed circuit  
#6-32 screw

**07** - extended pin  
#6-32 screw

**51\*** - handwired  
#8-32 screw

**52\*** - printed circuit  
#8-32 screw

### Base/End



**1** - mount end

**2** - barrier end

### Poles



**02 to 22** barrier  
end

**02 to 20**  
on mount  
end

### Screw Options

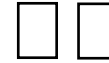

**07** - steel SEMS  
(standard)

**09** - brass SEMS  
nickel-plated

**CA** - SEMS captive

### Options



**A7 to A9** - 0.250" QC

**B7 to B9** - 0.187" QC

**EB** exit back terminals  
**L1 to L6** marking options  
(pg 25)

**LT1 to LT6** marking options  
(pg 25)

**MP** mtg. plates (pg 20)

**Covers** - (pg 26)

\*Note: #8-32 screw is a special with #6-32 head.

## Terminal Styles Inches (Millimeters)

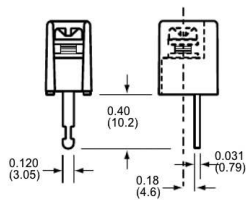

**01**

Handwired #6-32 screw

**51**

Handwired #8-32 screw

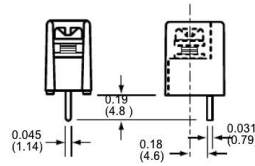

**02**

Printed Circuit #6-32 screw

**52**

Printed Circuit #8-32 screw

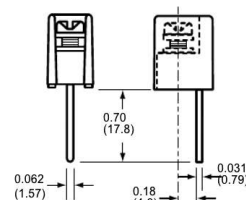

**07**

Extended Pin #6-32  
screw

## Screw Options

(Bulk ordering part numbers are in parentheses)



**07**

Steel SEMS  
Zinc-Plated  
(standard)  
(B001-7084-J)



**09**

Brass SEMS  
Nickel-Plated  
(F524-J)

## CB3 Terminal Exit Options Inches (Millimeters)

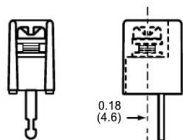

**Exit Rear** (std.)

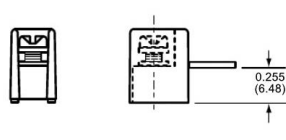

**EB**  
**Exit Back**

## Hardware Options

Inches (Millimeters)

(Bulk ordering part numbers are in parentheses)

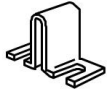

†OJ3  
(OJ3-J)

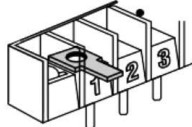

A7 & B7  
(2A7-J & 2B7-J)

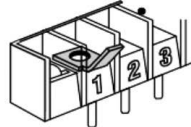

A8 & B8  
(2A8-J & 2B8-J)



A9 & B9  
(2A9-J & 2B9-J)



†OJ7  
(OJ7-J)

† Contact Eaton for desired configuration.

## Mounting Options Inches (Millimeters)

### Mounting Plates

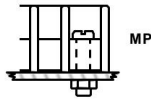
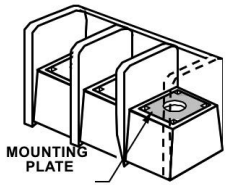

#### Options MP

MP Metal inserts with 0.150" dia. hole accept #6 screw.

## Contact Us

### Sales and Customer Service

#### Americas

Email: [elx.americas@eaton.com](mailto:elx.americas@eaton.com)

#### Europe, Middle East, Africa

Email: [elx.emea@eaton.com](mailto:elx.emea@eaton.com)

#### China

Email: [elx.cn@eaton.com](mailto:elx.cn@eaton.com)

#### Japan

Email: [elx.jp@eaton.com](mailto:elx.jp@eaton.com)

#### Korea

Email: [elx.kr@eaton.com](mailto:elx.kr@eaton.com)

#### South East Asia

Email: [elx.sea@eaton.com](mailto:elx.sea@eaton.com)

#### Taiwan

Email: [elx.tw@eaton.com](mailto:elx.tw@eaton.com)

### Global Technical Support

Magnetics: [InductorTech@eaton.com](mailto:InductorTech@eaton.com)

Circuit Protection: [FuseTech@eaton.com](mailto:FuseTech@eaton.com)

Supercapacitors: [CapacitorTech@eaton.com](mailto:CapacitorTech@eaton.com)

[www.eaton.com/terminalblocks](http://www.eaton.com/terminalblocks)

## Tools

### Eaton's Electronics Product Selection Tools



#### PARAMETRIC SEARCH

Drill down into the Eaton Electronics product database to find the right part for your application.



#### IC MATCHING

Find the Eaton Electronics parts called out on IC manufacturers' demo and evaluation boards.



#### CROSS REFERENCE

Find a cross to a competitor's product or to an alternate Eaton Electronics part number.



#### SUPERCAPACITOR CALCULATOR

Determine your calculated requirements and design capability.



#### TERMINAL BLOCK SELECTOR

Find the right terminal block for any application.



#### AUTOMOTIVE ELECTRONICS SOLUTIONS

Find electronics components for automotive solutions.

[tools.eatonelectronics.com](http://tools.eatonelectronics.com)



Компания «Океан Электроники» предлагает заключение долгосрочных отношений при поставках импортных электронных компонентов на взаимовыгодных условиях!

Наши преимущества:

- Поставка оригинальных импортных электронных компонентов напрямую с производств Америки, Европы и Азии, а так же с крупнейших складов мира;
- Широкая линейка поставок активных и пассивных импортных электронных компонентов (более 30 млн. наименований);
- Поставка сложных, дефицитных, либо снятых с производства позиций;
- Оперативные сроки поставки под заказ (от 5 рабочих дней);
- Экспресс доставка в любую точку России;
- Помощь Конструкторского Отдела и консультации квалифицированных инженеров;
- Техническая поддержка проекта, помощь в подборе аналогов, поставка прототипов;
- Поставка электронных компонентов под контролем ВП;
- Система менеджмента качества сертифицирована по Международному стандарту ISO 9001;
- При необходимости вся продукция военного и аэрокосмического назначения проходит испытания и сертификацию в лаборатории (по согласованию с заказчиком);
- Поставка специализированных компонентов военного и аэрокосмического уровня качества (Xilinx, Altera, Analog Devices, Intersil, Interpoint, Microsemi, Actel, Aeroflex, Peregrine, VPT, Syfer, Eurofarad, Texas Instruments, MS Kennedy, Miteq, Cobham, E2V, MA-COM, Hittite, Mini-Circuits, General Dynamics и др.);

Компания «Океан Электроники» является официальным дистрибьютором и эксклюзивным представителем в России одного из крупнейших производителей разъемов военного и аэрокосмического назначения «JONHON», а так же официальным дистрибьютором и эксклюзивным представителем в России производителя высокотехнологичных и надежных решений для передачи СВЧ сигналов «FORSTAR».



## JONHON

«JONHON» (основан в 1970 г.)

Разъемы специального, военного и аэрокосмического назначения:

(Применяются в военной, авиационной, аэрокосмической, морской, железнодорожной, горно- и нефтедобывающей отраслях промышленности)

«FORSTAR» (основан в 1998 г.)

ВЧ соединители, коаксиальные кабели, кабельные сборки и микроволновые компоненты:

(Применяются в телекоммуникациях гражданского и специального назначения, в средствах связи, РЛС, а так же военной, авиационной и аэрокосмической отраслях промышленности).



Телефон: 8 (812) 309-75-97 (многоканальный)

Факс: 8 (812) 320-03-32

Электронная почта: [ocean@oceanchips.ru](mailto:ocean@oceanchips.ru)

Web: <http://oceanchips.ru/>

Адрес: 198099, г. Санкт-Петербург, ул. Калинина, д. 2, корп. 4, лит. А