

TGA4533-SM

K-Band Power Amplifier



Applications

- Point-to-Point Radio
- K-Band Sat-Com

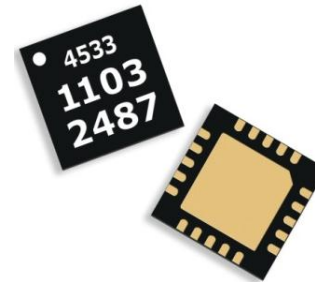

QFN 4x4 mm 20L

Product Features

- Frequency Range: 21.2 – 23.6 GHz
- Power: 32 dBm Psat, 31 dBm P1dB
- Gain: 22 dB
- TOI: 41 dBm at 21 dBm SCL
- NF: 6 dB
- Integrated Power Detector
- Bias: $V_d = 6\text{ V}$, $I_{dq} = 880\text{ mA}$, $V_g = -0.7\text{ V}$ Typical
- Package Dimensions: 4.0 x 4.0 x 0.85 mm

Functional Block Diagram

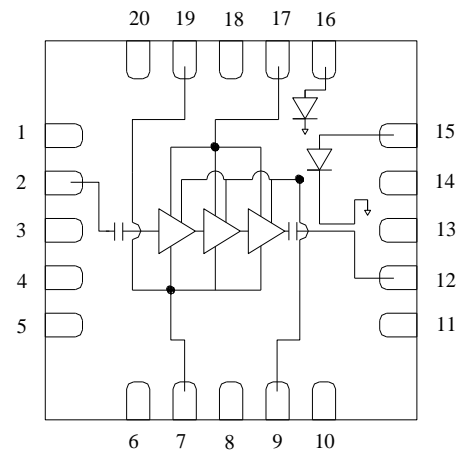

General Description

The TriQuint TGA4533-SM is a K-Band Power Amplifier. The TGA4533-SM operates from 21.2 – 23.6 GHz and is designed using TriQuint’s power pHEMT production process.

The TGA4533-SM typically provides 31 dBm of output power at 1dB gain compression with small signal gain of 22 dB. Third Order Intercept is 41 dBm at 21 dBm SCL.

The TGA4533-SM is available in a low-cost, surface mount 20 lead 4x4 QFN package. It is ideally suited for Point-to-Point Radio, and K-Band Sat-Com.

Lead-free and RoHS compliant

Evaluation Boards are available upon request.

Pin Configuration

Pin #	Symbol
1, 3, 4, 5, 6, 10, 11, 13, 14, 20	N/C
2	RF IN
7, 19	V_g
8, 18	GND
12	RF OUT
9, 17	V_d
15	V_{det}
16	V_{ref}

Ordering Information

Part No.	ECCN	Description
TGA4533-SM	EAR99	K-Band Power Amplifier

Standard T/R size = 500 pieces on a 7” reel.

Specifications

Absolute Maximum Ratings

Parameter	Rating
Drain Voltage, Vd	+6.5 V
Gate Voltage, Vg	-3 to 0 V
Drain to Gate Voltage, Vd – Vg	10 V
Drain Current, Id	2 A
Gate Current, Ig	-8.8 to 113 mA
Power Dissipation, P _{diss}	12.7 W
RF Input Power, CW, T = 25°C	26 dBm
Channel Temperature, T _{ch}	200 °C
Mounting Temperature (30 Seconds)	260 °C
Storage Temperature	-40 to 150 °C

Operation of this device outside the parameter ranges given above may cause permanent damage. These are stress ratings only, and functional operation of the device at these conditions is not implied.

Recommended Operating Conditions

Parameter	Min	Typical	Max	Units
Vd		6		V
Idq		880		mA
Id_drive (Under RF Drive)		1300		mA
Vg		-0.7		V

Electrical specifications are measured at specified test conditions. Specifications are not guaranteed over all recommended operating conditions.

Electrical Specifications

Test conditions unless otherwise noted: 25 °C, Vd = 6 V, Idq = 880 mA, Vg = -0.7 V Typical.

Parameter	Min	Typical	Max	Units
Operational Frequency Range	21.2		23.6	GHz
Gain	19	22		dB
Input Return Loss, IRL		10		dB
Output Return Loss, ORL		10		dB
Output Power @ Saturation, P _{sat}	30	32		dBm
Output Power @ 1dB Gain Compression, P _{1dB}	28	31		dBm
Output Third Order Intercept, TOI	38.5	41		dBm
Noise Figure, NF		6		dB
Gain Temperature Coefficient		-0.025		dB/°C
Power Temperature Coefficient		-0.015		dB/°C

Specifications (cont.)

Thermal and Reliability Information

Parameter	Condition	Rating
Thermal Resistance, θ_{JC} , measured to back of package	Tbase = 85 °C	$\theta_{JC} = 9.0$ °C/W
Channel Temperature (Tch), and Median Lifetime (Tm)	Tbase = 85 °C, Vd = 6 V, Idq = 880 mA, Pdiss = 5.28 W	Tch = 133 °C Tm = 7.4 E+6 Hours
Channel Temperature (Tch), and Median Lifetime (Tm) Under RF Drive	Tbase = 85 °C, Vd = 6 V, Id = 1300 mA, Pout = 31 dBm, Pdiss = 6.2 W	Tch = 144 °C Tm = 2.0 E+6 Hours

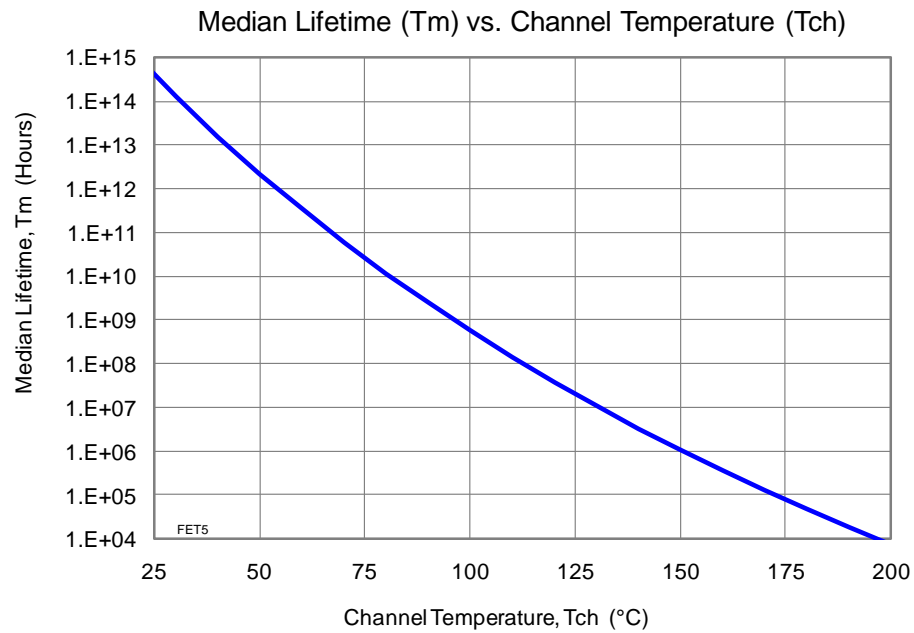

Typical Performance

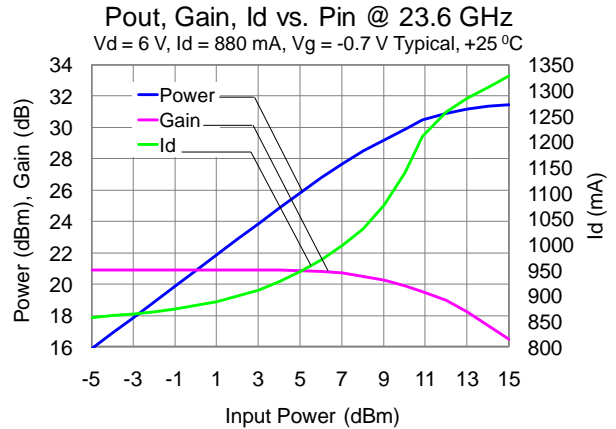
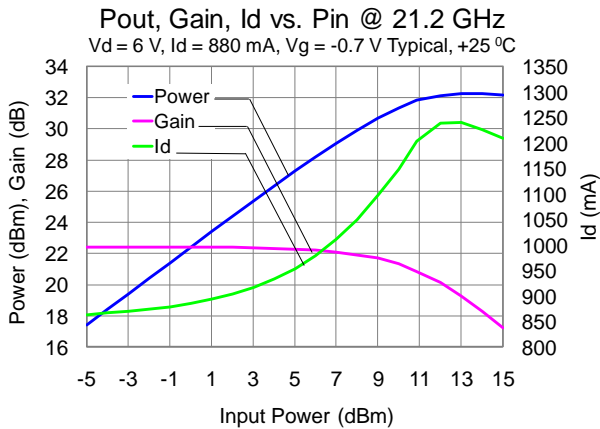
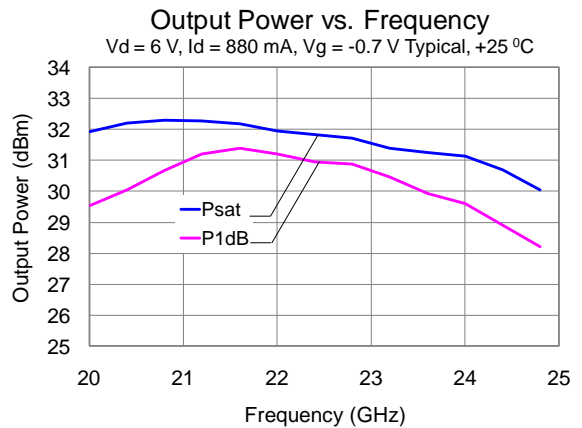
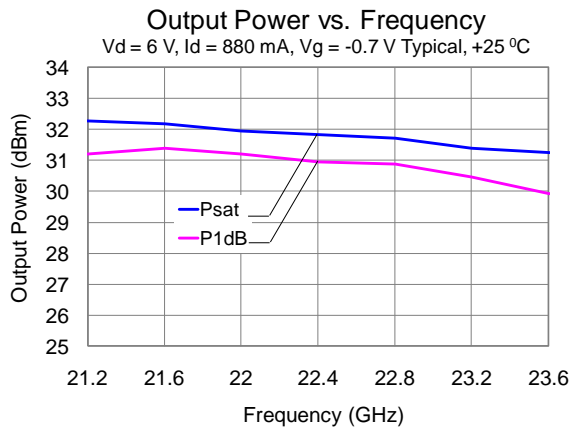
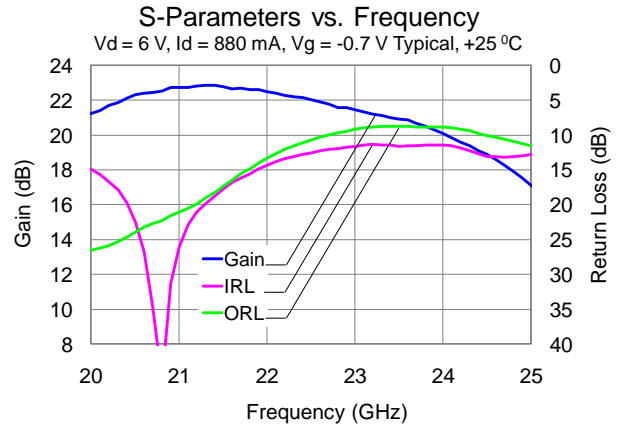
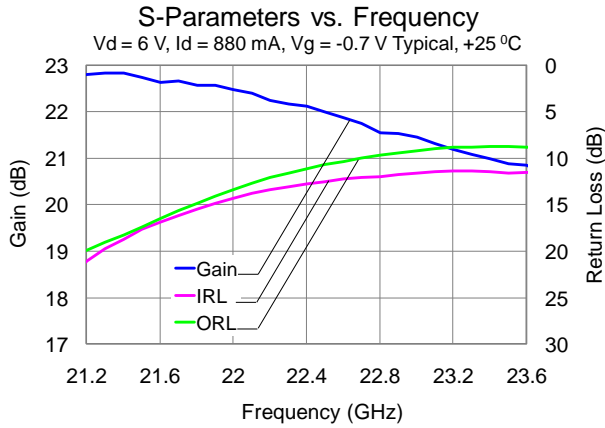

Typical Performance (cont.)

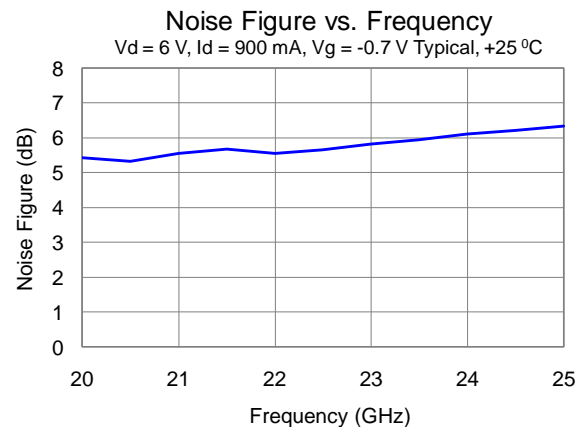
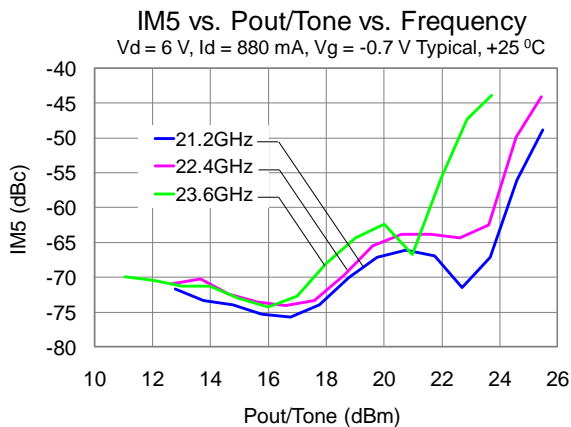
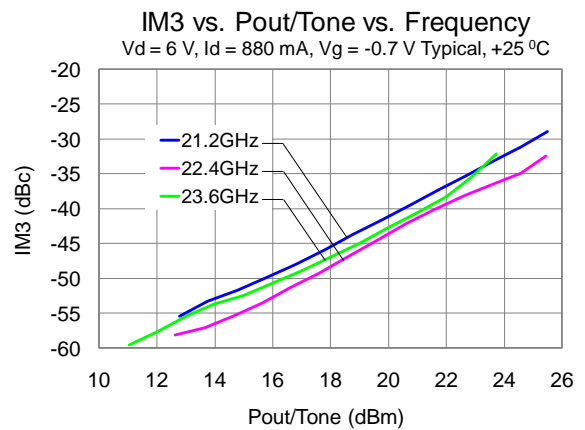
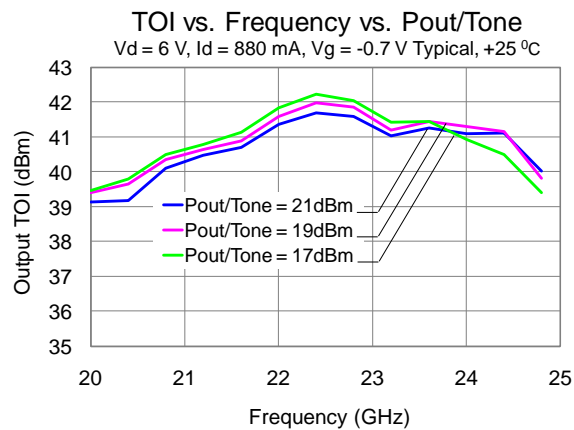
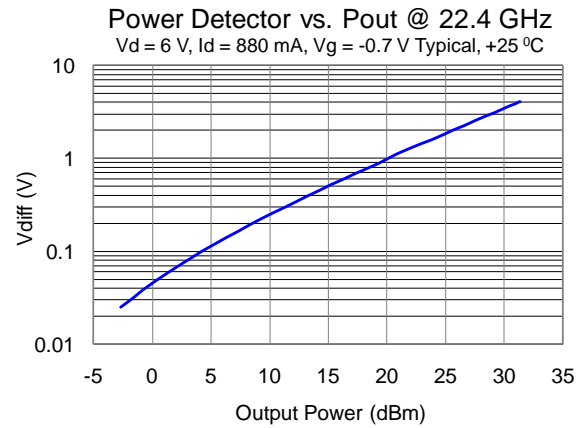
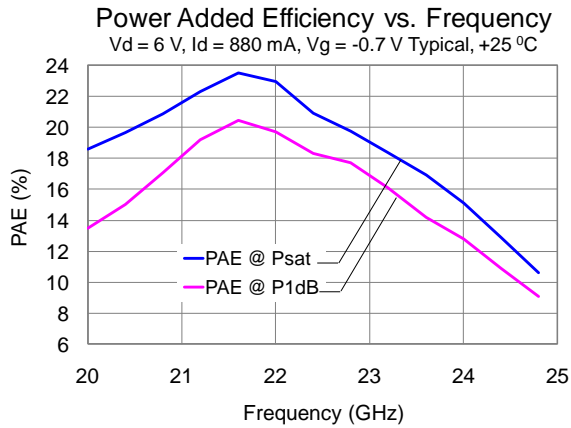

Typical Performance (cont.)

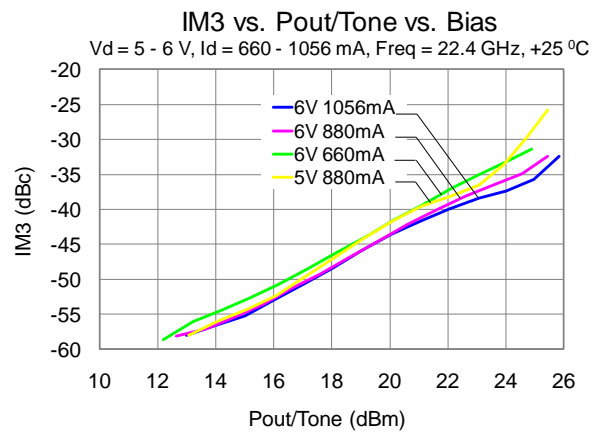
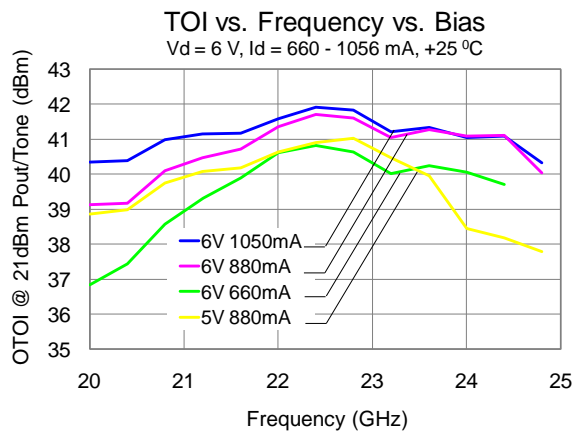
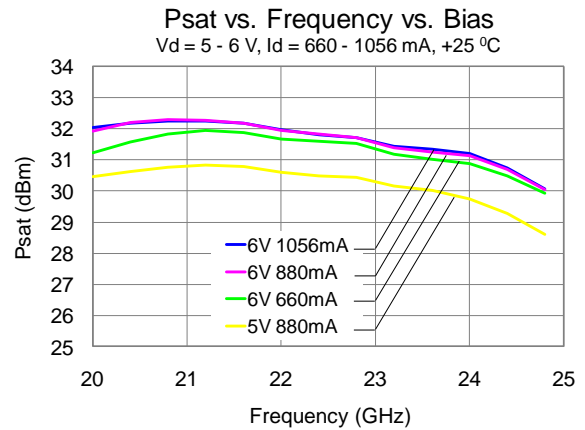
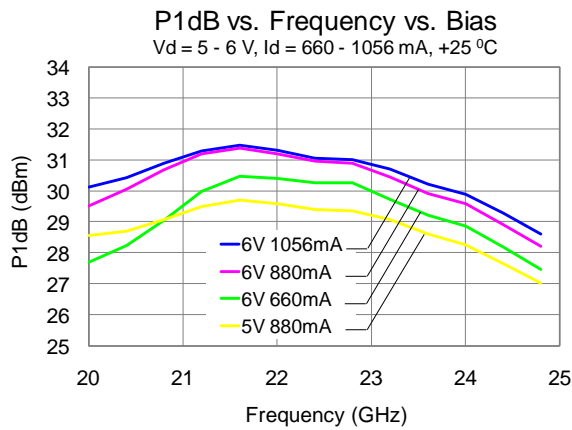
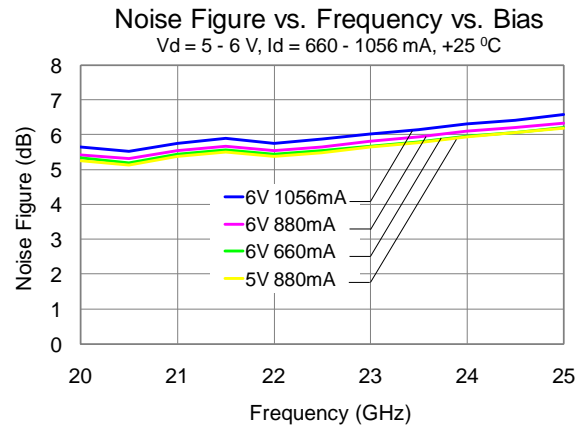
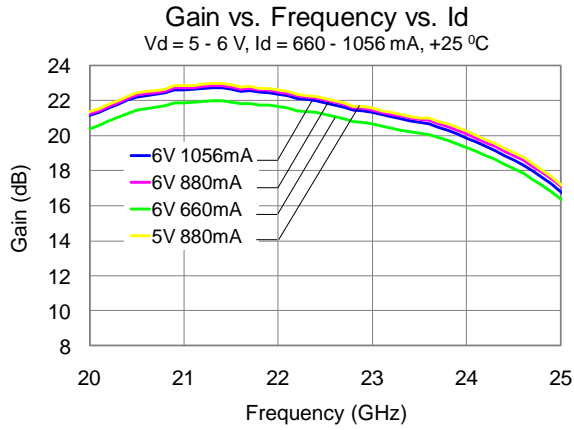

Typical Performance (cont.)

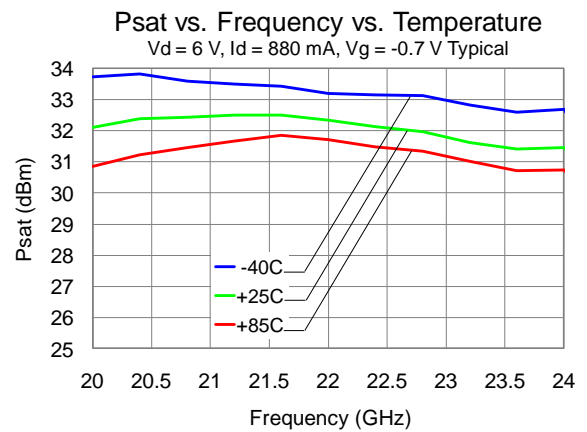
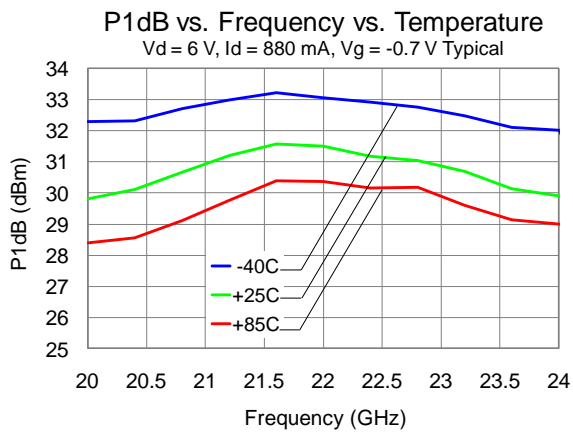
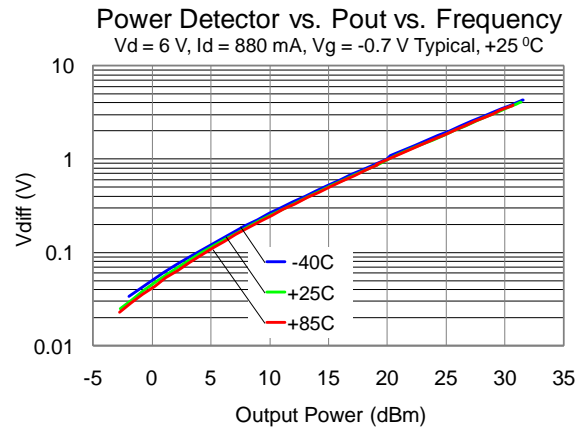
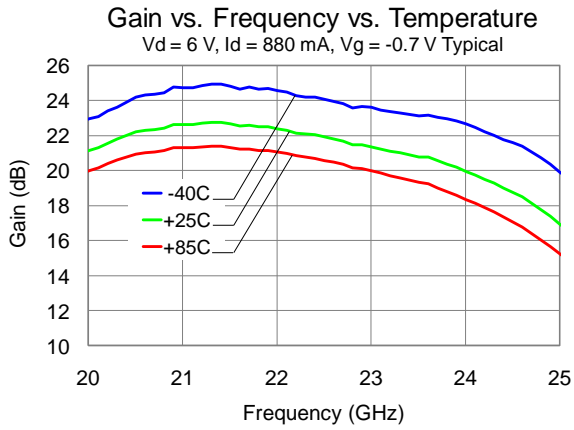

Application Circuit

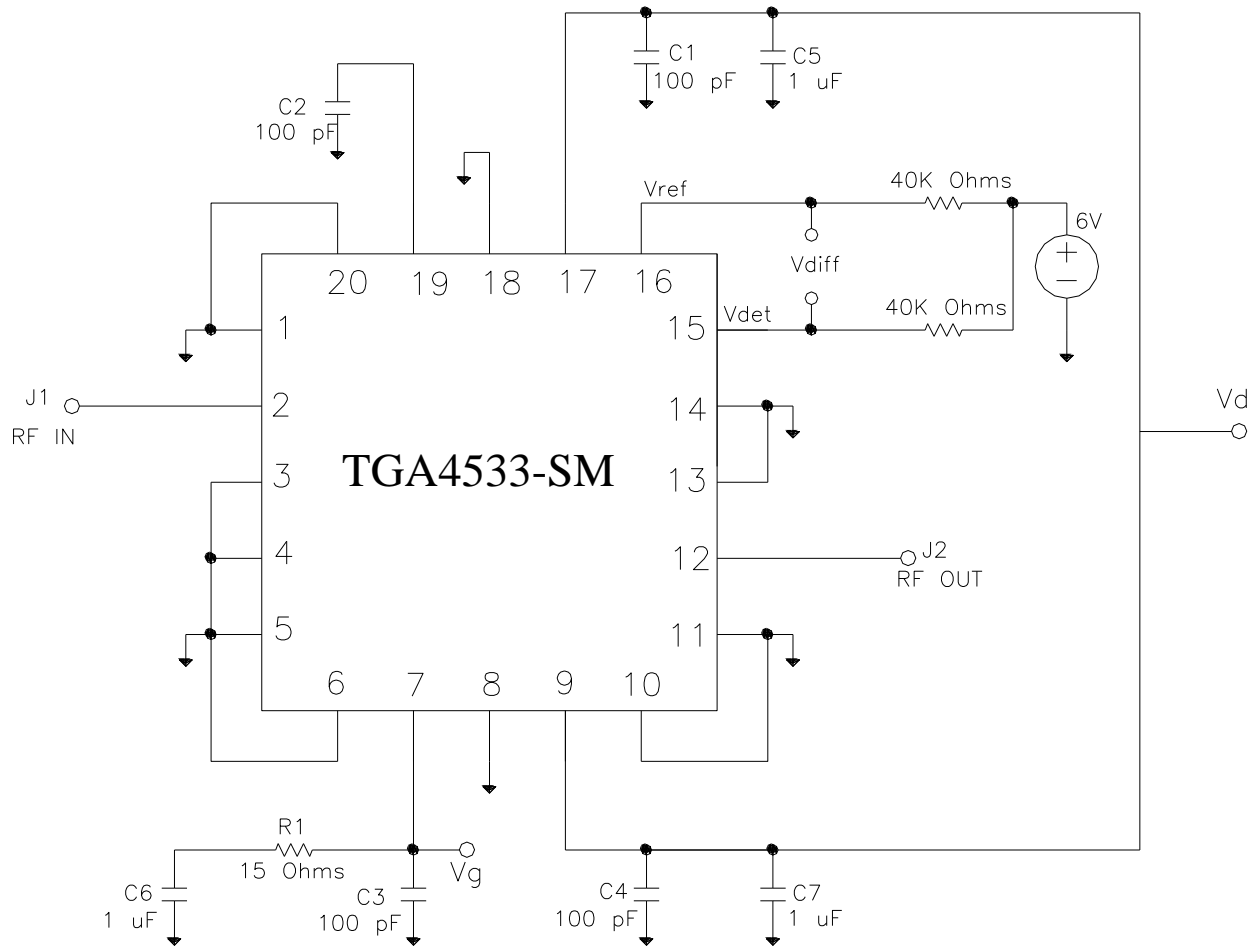

Vg can be biased from either side (pin 7 or pin 19), and the non-biased side can be left open.
Vd must be biased from both sides (pin 9 and pin 17).

Bias-up Procedure

Vg set to -1.5 V
Vd set to +6 V
Adjust Vg more positive until quiescent Id is 880 mA.
This will be ~ Vg = -0.7 V typical
Apply RF signal to RF Input

Bias-down Procedure

Turn off RF supply
Reduce Vg to -1.5V. Ensure Id ~ 0 mA
Turn Vd to 0 V
Turn Vg to 0 V

Pin Description

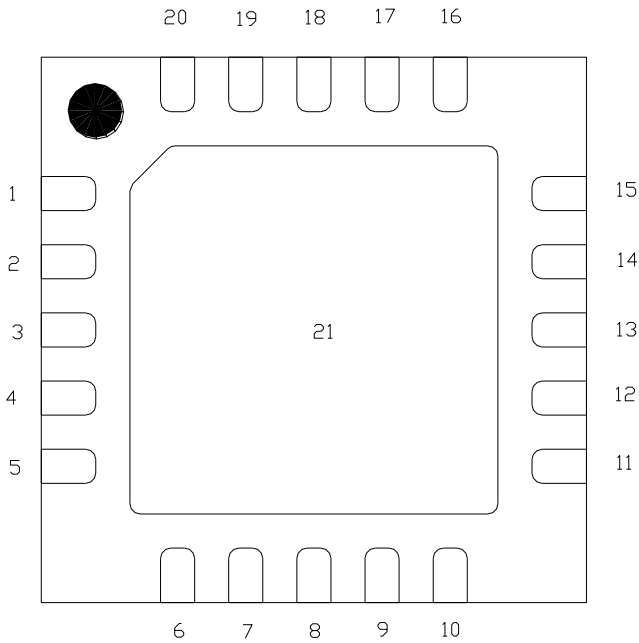

Pin	Symbol	Description
1, 3, 4, 5, 6, 10, 11, 13, 14, 20	N/C	No internal connection; must be grounded on PCB
2	RF IN	Input, matched to 50 ohms
7, 19	V _g	Gate voltage. Bias network is required; can be biased from either pin, and non-biased pin can be left opened; see Application Circuit on page 8 as an example.
8, 18	GND	Internal grounding; can be grounded or left open on PCB
12	RF OUT	Output, matched to 50 ohms
9, 17	V _d	Drain voltage. Bias network is required; must be biased from both pins; see Application Circuit on page 8 as an example.
15	V _{det}	Detector diode output voltage. Varies with RF output power.
16	V _{ref}	Reference diode output voltage.
21	GND	Backside Paddle. Multiple vias should be employed to minimize inductance and thermal resistance; see Mounting Configuration on page 12 for suggested footprint.

Applications Information

PC Board Layout

Top RF layer is 0.008” thick Rogers RO4003, $\epsilon_r = 3.38$. Metal layers are 0.5-oz copper. Microstrip 50 Ω line detail: width = 0.0175”.

The pad pattern shown has been developed and tested for optimized assembly at TriQuint Semiconductor. The PCB land pattern has been developed to accommodate lead and package tolerances. Since surface mount processes vary from company to company, careful process development is recommended.

For further technical information, refer to the [TGA4533-SM](#) Product Information page.

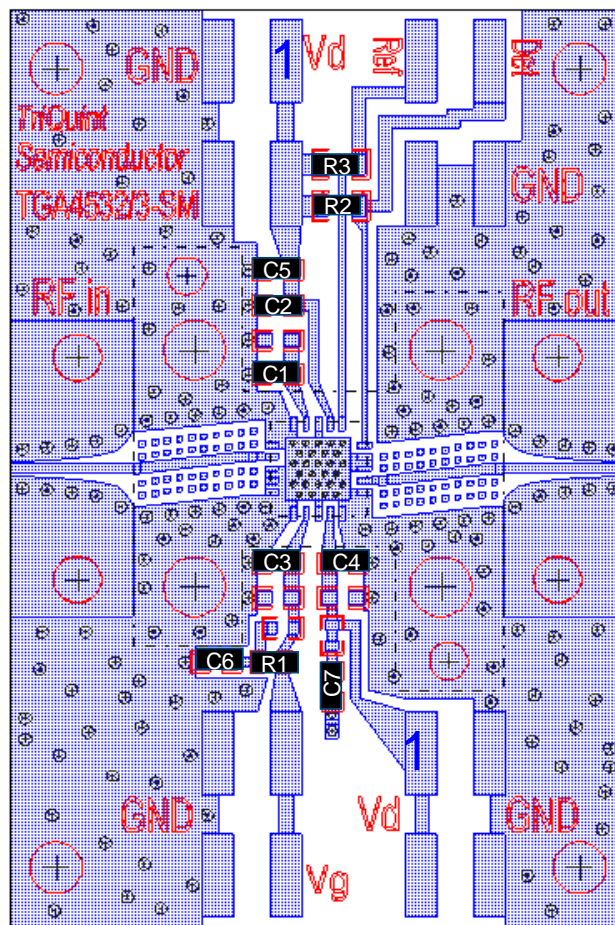
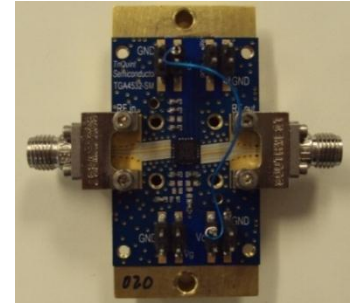

Bill of Material

Ref Des	Value	Description	Manufacturer	Part Number
C1, C2, C3, C4	100 pF	Cap, 0402, 50 V, 5%, COG	various	
C5, C6, C7	1 uF	Cap, 0603, 25 V, 10%, X5R	various	
R1	15 Ohms	Res, 0402, 0.1 W, 5%, SMD	various	
R2, R3	40K Ohms	Res, 0603, 0.1 W, 5%, SMD	various	

Mechanical Information

Package Information and Dimensions

All dimensions are in millimeters.

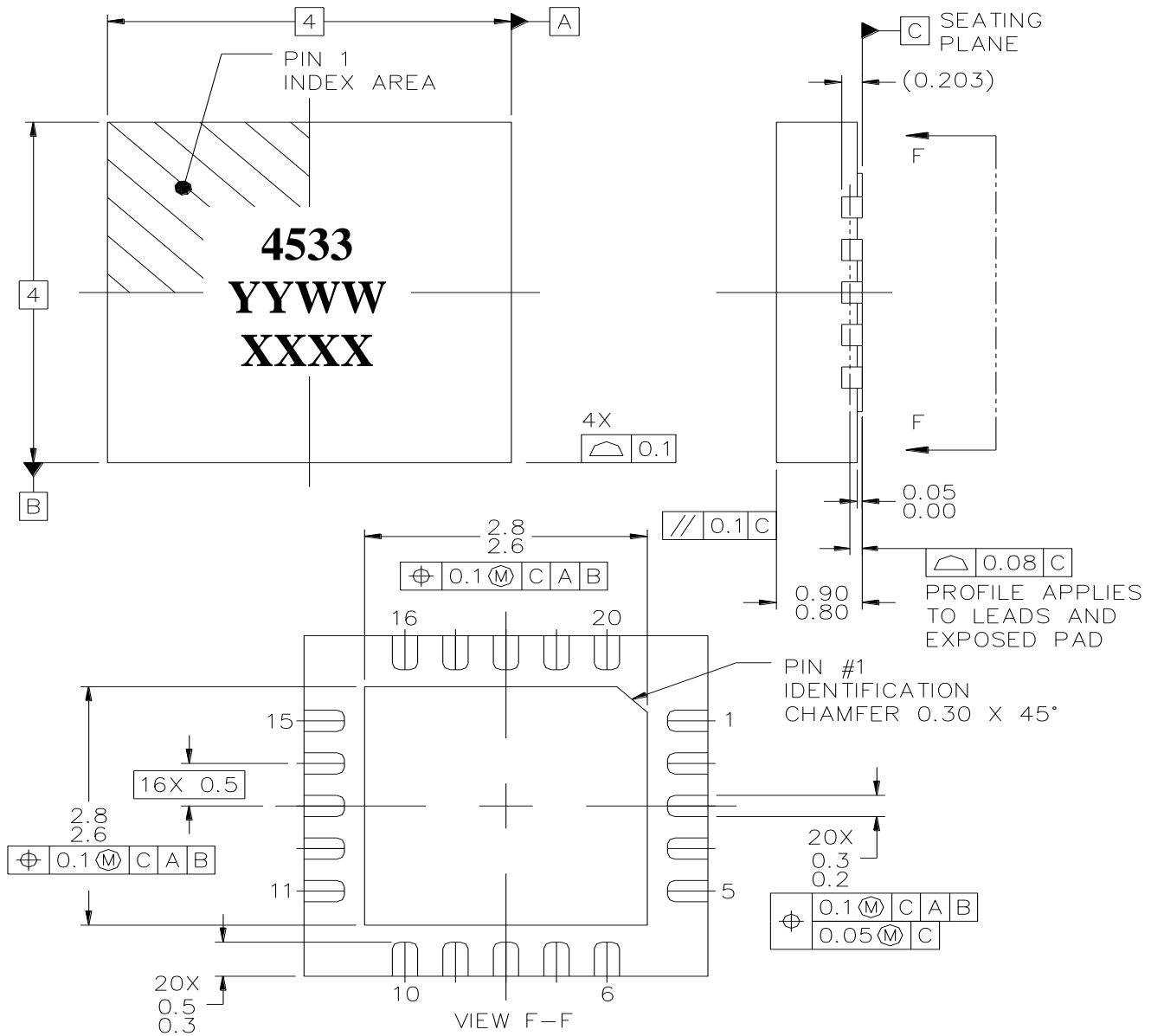

This package is lead-free/RoHS-compliant. The package base is copper alloy and the plating material on the leads is NiPdAu. It is compatible with both lead-free (maximum 260 °C reflow temperature) and tin-lead (maximum 245 °C reflow temperature) soldering processes.

The TGA4533-SM will be marked with the "4533" designator and a lot code marked below the part designator. The "YY" represents the last two digits of the year the part was manufactured, the "WW" is the work week, and the "XXXX" is an auto-generated number.

Mechanical Information (cont.)

Mounting Configuration

All dimensions are in millimeters (inches).

Notes:

1. A heatsink underneath the area of the PCB for the mounted device is recommended for proper thermal operation.
2. Ground / thermal vias are critical for the proper performance of this device. Vias have a final plated thru diameter of 0.254 mm (0.010").

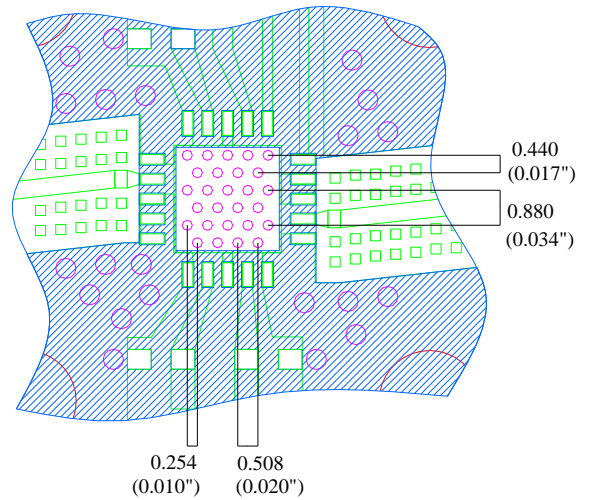

Tape and Reel Information

Tape and reel specifications for this part are also available on the TriQuint website in the “Application Notes” section.
 Standard T/R size = 500 pieces on a 7 x 0.5” reel.

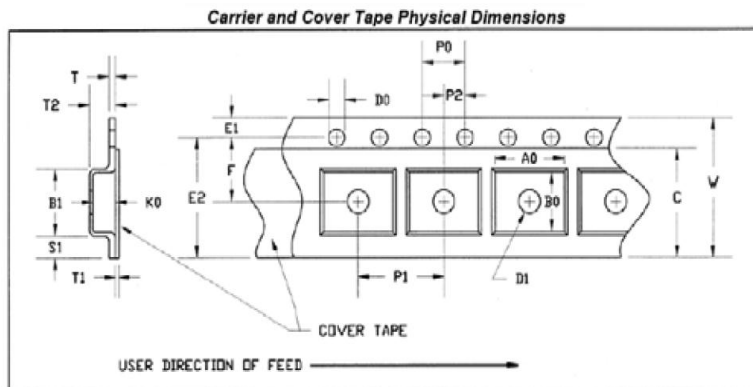

CARRIER AND COVER TAPE DIMENSIONS

Part	Feature	Symbol	Size (in)	Size (mm)
Cavity	Length	A0	0.171	4.35
	Width	B0	0.171	4.35
	Depth	K0	0.043	1.1
	Pitch	P1	0.315	8.0
Distance Between Centerline	Cavity to Perforation Length Direction	P2	0.079	2.0
	Cavity to Perforation Width Direction	F	0.217	5.5
Cover Tape	Width	C	0.374	9.5
Carrier Tape	Width	W	0.472	12.0

Product Compliance Information

ESD Information



Caution! ESD-Sensitive Device

ESD Rating: Class 1A
 Value: $\geq 250V$ and $\leq 500V$
 Test: Human Body Model (HBM)
 Standard: JEDEC Standard JESD22-A114

MSL Rating

Level 1 at +260 °C convection reflow
 The part is rated Moisture Sensitivity Level 1 at 260°C per JEDEC standard IPC/JEDEC J-STD-020.

ECCN

US Department of Commerce EAR99

Solderability

Compatible with the latest version of J-STD-020, Lead free solder, 260°

This part is compliant with EU 2002/95/EC RoHS directive (Restrictions on the Use of Certain Hazardous Substances in Electrical and Electronic Equipment).

This product also has the following attributes:

- Lead Free
- Halogen Free (Chlorine, Bromine)
- Antimony Free
- TBBP-A (C₁₅H₁₂Br₄O₂) Free
- PFOS Free
- SVHC Free

Recommended Soldering Temperature Profile

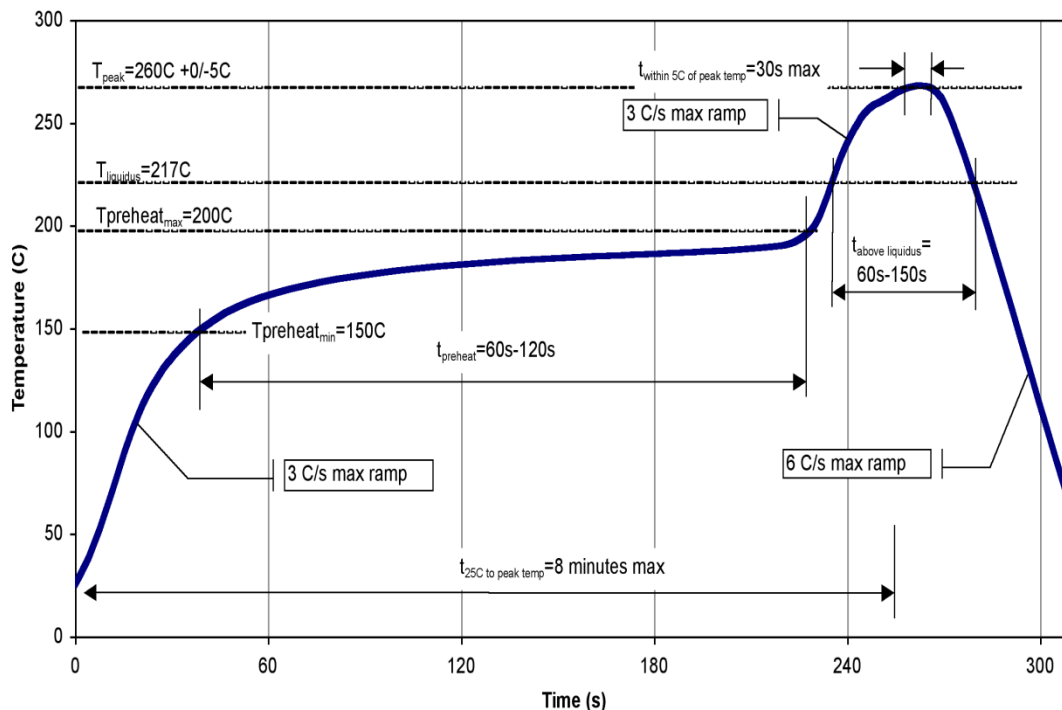

TGA4533-SM

K-Band Power Amplifier



Contact Information

For the latest specifications, additional product information, worldwide sales and distribution locations, and information about TriQuint:

Web: www.triquint.com
Email: info-sales@tqs.com

Tel: +1.972.994.8465
Fax: +1.972.994.8504

For technical questions and application information:

Email: info-networks@tqs.com

Important Notice

The information contained herein is believed to be reliable. TriQuint makes no warranties regarding the information contained herein. TriQuint assumes no responsibility or liability whatsoever for any of the information contained herein. TriQuint assumes no responsibility or liability whatsoever for the use of the information contained herein. The information contained herein is provided "AS IS, WHERE IS" and with all faults, and the entire risk associated with such information is entirely with the user. All information contained herein is subject to change without notice. Customers should obtain and verify the latest relevant information before placing orders for TriQuint products. The information contained herein or any use of such information does not grant, explicitly or implicitly, to any party any patent rights, licenses, or any other intellectual property rights, whether with regard to such information itself or anything described by such information.

TriQuint products are not warranted or authorized for use as critical components in medical, life-saving, or life-sustaining applications, or other applications where a failure would reasonably be expected to cause severe personal injury or death.

Copyright © 2015 TriQuint Semiconductor, Inc. All rights reserved.

Компания «Океан Электроники» предлагает заключение долгосрочных отношений при поставках импортных электронных компонентов на взаимовыгодных условиях!

Наши преимущества:

- Поставка оригинальных импортных электронных компонентов напрямую с производств Америки, Европы и Азии, а так же с крупнейших складов мира;
- Широкая линейка поставок активных и пассивных импортных электронных компонентов (более 30 млн. наименований);
- Поставка сложных, дефицитных, либо снятых с производства позиций;
- Оперативные сроки поставки под заказ (от 5 рабочих дней);
- Экспресс доставка в любую точку России;
- Помощь Конструкторского Отдела и консультации квалифицированных инженеров;
- Техническая поддержка проекта, помощь в подборе аналогов, поставка прототипов;
- Поставка электронных компонентов под контролем ВП;
- Система менеджмента качества сертифицирована по Международному стандарту ISO 9001;
- При необходимости вся продукция военного и аэрокосмического назначения проходит испытания и сертификацию в лаборатории (по согласованию с заказчиком);
- Поставка специализированных компонентов военного и аэрокосмического уровня качества (Xilinx, Altera, Analog Devices, Intersil, Interpoint, Microsemi, Actel, Aeroflex, Peregrine, VPT, Syfer, Eurofarad, Texas Instruments, MS Kennedy, Miteq, Cobham, E2V, MA-COM, Hittite, Mini-Circuits, General Dynamics и др.);

Компания «Океан Электроники» является официальным дистрибьютором и эксклюзивным представителем в России одного из крупнейших производителей разъемов военного и аэрокосмического назначения «JONHON», а так же официальным дистрибьютором и эксклюзивным представителем в России производителя высокотехнологичных и надежных решений для передачи СВЧ сигналов «FORSTAR».



JONHON

«JONHON» (основан в 1970 г.)

Разъемы специального, военного и аэрокосмического назначения:

(Применяются в военной, авиационной, аэрокосмической, морской, железнодорожной, горно- и нефтедобывающей отраслях промышленности)

«FORSTAR» (основан в 1998 г.)

ВЧ соединители, коаксиальные кабели, кабельные сборки и микроволновые компоненты:

(Применяются в телекоммуникациях гражданского и специального назначения, в средствах связи, РЛС, а так же военной, авиационной и аэрокосмической отраслях промышленности).



Телефон: 8 (812) 309-75-97 (многоканальный)

Факс: 8 (812) 320-03-32

Электронная почта: ocean@oceanchips.ru

Web: <http://oceanchips.ru/>

Адрес: 198099, г. Санкт-Петербург, ул. Калинина, д. 2, корп. 4, лит. А