

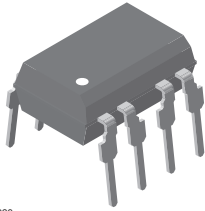

High Speed Optocoupler, Dual Channel, 1 MBd, Transistor Output

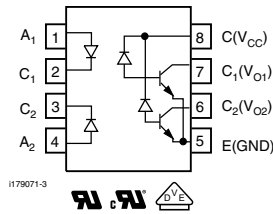

i179026



FEATURES

- Isolation test voltage, 5300 V_{RMS}
- TTL compatible
- Bit rates: 1 MBit/s
- High common mode transient immunity
- Bandwidth 2 MHz
- Open collector output
- Compliant to RoHS Directive 2002/95/EC and in accordance to WEEE 2002/96/EC



RoHS COMPLIANT

DESCRIPTION

The SFH6325 and SFH6326 are dual channel optocouplers with a GaAIAs infrared emitting diode, optically coupled with an integrated photo detector which consists of a photo diode and a high-speed transistor in a DIP-8 plastic package. Signals can be transmitted between two electrically separated circuits up to frequencies of 2 MHz. The potential difference between the circuits to be coupled should not exceed the maximum permissible reference voltages.

AGENCY APPROVALS

- UL1577, file no. E52744 system code H double protection
- cUL tested to CSA 22.2 bulletin 5A
- DIN EN 60747-5-2 (VDE0884)/DIN EN 60747-5-5 (pending), available with option 1

ORDERING INFORMATION

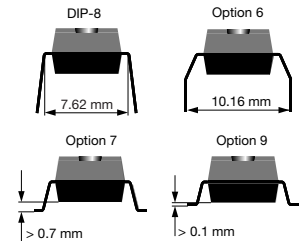
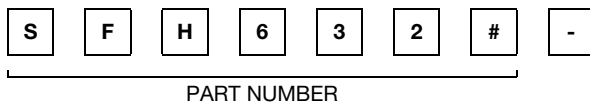

AGENCY CERTIFIED/PACKAGE	CTR (%)	
	≥ 7	≥ 19
UL, cUL		
DIP-8	SFH6325	SFH6326
DIP-8, 400 mil, option 6	-	SFH6326-X006
SMD-8, option 7	-	SFH6326-X007T ⁽¹⁾
SMD-8, option 9	SFH6325-X009T ⁽¹⁾	SFH6326-X009T ⁽¹⁾
VDE, UL, cUL		
DIP-8	-	SFH6326-X001
SMD-8, option 7	SFH6325-X017T	SFH6326-X017T ⁽¹⁾

Note

- Additional options may be possible, please contact sales office.
- ⁽¹⁾ Also available in tubes; do not add T to end.

ABSOLUTE MAXIMUM RATINGS (T_{amb} = 25 °C, unless otherwise specified)

PARAMETER	TEST CONDITION	SYMBOL	VALUE	UNIT
INPUT				
Reverse voltage		V _R	4.5	V
Forward continuous current		I _F	25	mA
Peak forward current	t = 1 ms, duty cycle 50 %	I _{FM}	50	mA
Maximum surge forward current	t ≤ 1 μs, 300 pulses/s	I _{FSM}	1	A
Derate linearly from 25 °C			0.6	mW/°C
Power dissipation	T _{amb} ≤ 70 °C	P _{diss}	50	mW



ABSOLUTE MAXIMUM RATINGS ($T_{amb} = 25\text{ }^{\circ}\text{C}$, unless otherwise specified)				
PARAMETER	TEST CONDITION	SYMBOL	VALUE	UNIT
OUTPUT				
Supply voltage		V_S	- 0.5 to 30	V
Output voltage		V_O	- 0.5 to 25	V
Collector output current		I_{CO}	8	mA
Derate linearly from 25 °C			1.33	mW/°C
Power dissipation	$T_{amb} \leq 70\text{ }^{\circ}\text{C}$	P_{diss}	50	mW
COUPLER				
Isolation test voltage	$t = 1\text{ s}$	V_{ISO}	5300	V_{RMS}
Pollution degree (DIN VDE0109)			2	
Creepage distance			≥ 7	mm
Clearance distance			≥ 7	mm
Derate linearly from 25 °C			1.93	mW/°C
Total package dissipation		P_{tot}	145	mW
Comparative tracking index per DIN IEC112/VDE0303 part 1, group IIIa per DIN VDE6110			175	
Isolation resistance	$V_{IO} = 500\text{ V}, T_{amb} = 25\text{ }^{\circ}\text{C}$	R_{IO}	$\geq 10^{12}$	Ω
	$V_{IO} = 500\text{ V}, T_{amb} = 100\text{ }^{\circ}\text{C}$	R_{IO}	$\geq 10^{11}$	Ω
Storage temperature range		T_{stg}	- 55 to + 125	°C
Ambient temperature range		T_{amb}	- 55 to +100	°C
Soldering temperature ⁽¹⁾	max. 10 s, dip soldering distance to seating plane $\geq 1.5\text{ mm}$	T_{sld}	260	°C

Notes

- Stresses in excess of the absolute maximum ratings can cause permanent damage to the device. Functional operation of the device is not implied at these or any other conditions in excess of those given in the operational sections of this document. Exposure to absolute maximum ratings for extended periods of the time can adversely affect reliability.

⁽¹⁾ Refer to reflow profile for soldering conditions for surface mounted devices (SMD). Refer to wave profile for soldering conditions for through hole devices (DIP).

ELECTRICAL CHARACTERISTICS ($T_{amb} = 25\text{ }^{\circ}\text{C}$, unless otherwise specified)							
PARAMETER	TEST CONDITION	PART	SYMBOL	MIN.	TYP.	MAX.	UNIT
INPUT ⁽¹⁾							
Forward voltage	$I_F = 16\text{ mA}$		V_F		1.33	1.9	V
Breakdown voltage	$I_R = 10\text{ }\mu\text{A}$		V_{BR}	4.5			V
Reverse current	$V_R = 4.5\text{ V}$		I_R		0.5	10	μA
Capacitance	$V_R = 0\text{ V}, f = 1\text{ MHz}$		C_O		30		pF
Temperature coefficient of forward voltage	$I_F = 16\text{ mA}$		$\Delta V_F/\Delta T_{amb}$		- 1.7		mV/°C
OUTPUT							
Logic low supply current	$I_F = 16\text{ mA}, V_O = \text{open}, V_{CC} = 4.5\text{ V}$		I_{CCL}		100	200	μA
Supply current, logic high	$I_F = 0\text{ mA}, V_O = \text{open}, V_{CC} = 15\text{ V}$		I_{CCH}		0.01	4	μA
Logic low output voltage	$I_F = 16\text{ mA}, V_{CC} = 4.5\text{ V}, I_O = 1.1\text{ mA}$	SFH6325	V_{OL}		0.1	0.5	V
	$I_F = 16\text{ mA}, V_{CC} = 4.5\text{ V}, I_O = 3\text{ mA}$	SFH6326	V_{OL}		0.1	0.5	V
Logic high output current	$I_F = 0\text{ mA}, V_O = V_{CC} = 5.5\text{ V}$		I_{OH}		3	500	nA
	$I_F = 0\text{ mA}, V_O = V_{CC} = 15\text{ V}$		I_{OH}			50	μA
Channel to channel ⁽²⁾ crosstalk	$I_F = 16\text{ mA}, V_O = V_{CC} = 5.5\text{ V}$		I_{OH-XT}			500	nA
COUPLER							
Capacitance (input to output)	$f = 1\text{ MHz}$		C_{IO}		0.6		pF

Notes

- Minimum and maximum values are testing requirements. Typical values are characteristics of the device and are the result of engineering evaluation. Typical values are for information only and are not part of the testing requirements.

⁽¹⁾ $T_{amb} = 0\text{ }^{\circ}\text{C}$ to $70\text{ }^{\circ}\text{C}$, unless otherwise specified.

⁽²⁾ To measure crosstalk, turn on the LED for channel 1 and the output current for channel 2 in logic high. Repeat for channel 2.

CURRENT TRANSFER RATIO ($T_{amb} = 25\text{ }^{\circ}\text{C}$, unless otherwise specified)							
PARAMETER	TEST CONDITION	PART	SYMBOL	MIN.	TYP.	MAX.	UNIT
Current transfer ratio	$I_F = 16\text{ mA}$, $V_{CC} = 4.5\text{ V}$, $V_O = 0.4\text{ V}$, $T_{amb} = 25\text{ }^{\circ}\text{C}$	SFH6325	CTR	7	16		%
		SFH6326	CTR	19	35		%
	$I_F = 16\text{ mA}$, $V_{CC} = 4.5\text{ V}$, $V_O = 0.5\text{ V}$, $T_{amb} = 0\text{ }^{\circ}\text{C}$ to $70\text{ }^{\circ}\text{C}$	SFH6325	CTR	5			%
		SFH6326	CTR	15			%

SWITCHING CHARACTERISTICS ($T_{amb} = 25\text{ }^{\circ}\text{C}$, unless otherwise specified)							
PARAMETER	TEST CONDITION	PART	SYMBOL	MIN.	TYP.	MAX.	UNIT
High to low	$I_F = 16\text{ mA}$, $V_{CC} = 5\text{ V}$, $R_L = 4.1\text{ k}\Omega$	SFH6325	t_{PHL}		0.3	1.5	μs
	$I_F = 16\text{ mA}$, $V_{CC} = 5\text{ V}$, $R_L = 1.9\text{ k}\Omega$	SFH6326	t_{PHL}		0.2	0.8	μs
Low to high	$I_F = 16\text{ mA}$, $V_{CC} = 5\text{ V}$, $R_L = 4.1\text{ k}\Omega$	SFH6325	t_{PLH}		0.6	1.5	μs
	$I_F = 16\text{ mA}$, $V_{CC} = 5\text{ V}$, $R_L = 1.9\text{ k}\Omega$	SFH6326	t_{PLH}		0.5	0.8	μs

COMMON MODE TRANSIENT IMMUNITY ($T_{amb} = 25\text{ }^{\circ}\text{C}$, unless otherwise specified)							
PARAMETER	TEST CONDITION	PART	SYMBOL	MIN.	TYP.	MAX.	UNIT
CMTI at logic high level output	$I_F = 0\text{ mA}$, $C_{CM} = 10\text{ V}_{P-P}$, $V_{CC} = 5\text{ V}$, $R_L = 4.1\text{ k}\Omega$	SFH6325	CM_H		1000		$\text{V}/\mu\text{s}$
	$I_F = 0\text{ mA}$, $C_{CM} = 10\text{ V}_{P-P}$, $V_{CC} = 5\text{ V}$, $R_L = 1.9\text{ k}\Omega$	SFH6326	CM_H		1000		$\text{V}/\mu\text{s}$
CMTI at logic low level output	$I_F = 16\text{ mA}$, $C_{CM} = 10\text{ V}_{P-P}$, $V_{CC} = 5\text{ V}$, $R_L = 4.1\text{ k}\Omega$	SFH6325	CM_L		1000		$\text{V}/\mu\text{s}$
	$I_F = 16\text{ mA}$, $C_{CM} = 10\text{ V}_{P-P}$, $V_{CC} = 5\text{ V}$, $R_L = 1.9\text{ k}\Omega$	SFH6326	CM_L		1000		$\text{V}/\mu\text{s}$

TYPICAL CHARACTERISTICS ($T_{amb} = 25\text{ }^{\circ}\text{C}$, unless otherwise specified)

Fig. 1 - LED Forward Current vs. Forward Voltage

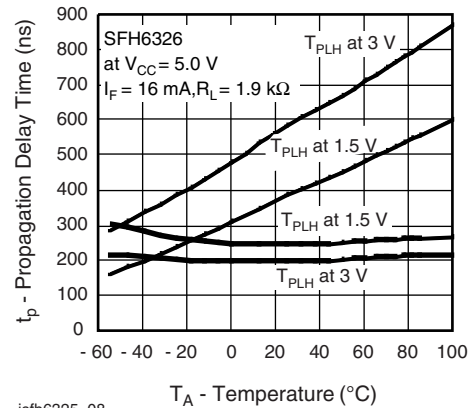

Fig. 2 - Permissible Forward LED Current vs. Temperature



isfh6325_05

Fig. 3 - Permissible Power Dissipation vs. Temperature



isfh6325_08

Fig. 6 - Propagation Delay vs. Ambient Temperature



isfh6325_06

Fig. 4 - Output Current vs. Output Voltage



isfh6325_09

Fig. 7 - Propagation Delay vs. Ambient Temperature



isfh6325_07

Fig. 5 - Output Current vs. Temperature

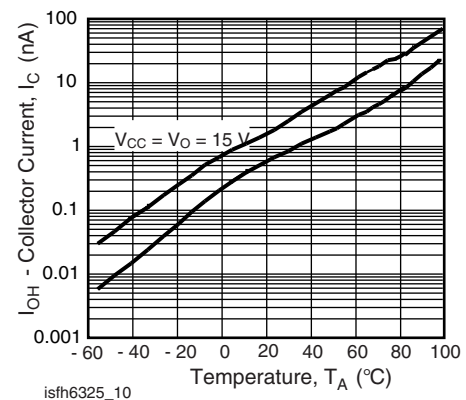

isfh6325_10

Fig. 8 - Logic High Output Current vs. Temperature



Fig. 9 - Small Signal Current Transfer Ratio vs. Input Current

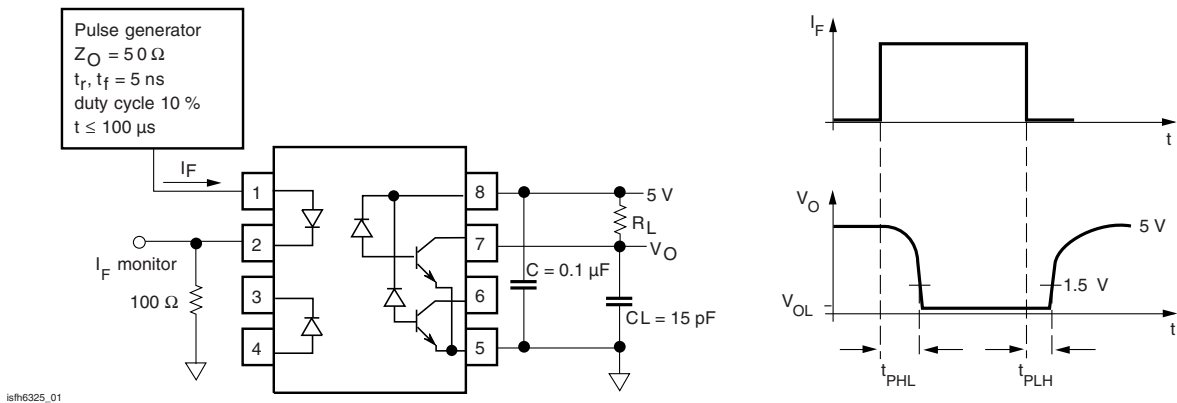
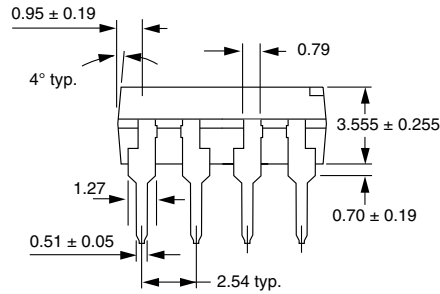

Fig. 10 - Switching Time and Test Circuit



Fig. 11 - Waveform and Test Circuit for Common Mode Transient Immunity

PACKAGE DIMENSIONS in millimeters



i178006



18450

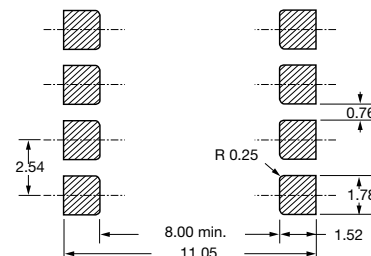

PACKAGE MARKING



21764-69

Notes

- Only options 1 and 7 are reflected in the package marking.
- The VDE Logo is only marked on option1 parts.
- Tape and reel suffix (T) is not part of the package marking.



Disclaimer

ALL PRODUCT, PRODUCT SPECIFICATIONS AND DATA ARE SUBJECT TO CHANGE WITHOUT NOTICE TO IMPROVE RELIABILITY, FUNCTION OR DESIGN OR OTHERWISE.

Vishay Intertechnology, Inc., its affiliates, agents, and employees, and all persons acting on its or their behalf (collectively, "Vishay"), disclaim any and all liability for any errors, inaccuracies or incompleteness contained in any datasheet or in any other disclosure relating to any product.

Vishay makes no warranty, representation or guarantee regarding the suitability of the products for any particular purpose or the continuing production of any product. To the maximum extent permitted by applicable law, Vishay disclaims (i) any and all liability arising out of the application or use of any product, (ii) any and all liability, including without limitation special, consequential or incidental damages, and (iii) any and all implied warranties, including warranties of fitness for particular purpose, non-infringement and merchantability.

Statements regarding the suitability of products for certain types of applications are based on Vishay's knowledge of typical requirements that are often placed on Vishay products in generic applications. Such statements are not binding statements about the suitability of products for a particular application. It is the customer's responsibility to validate that a particular product with the properties described in the product specification is suitable for use in a particular application. Parameters provided in datasheets and/or specifications may vary in different applications and performance may vary over time. All operating parameters, including typical parameters, must be validated for each customer application by the customer's technical experts. Product specifications do not expand or otherwise modify Vishay's terms and conditions of purchase, including but not limited to the warranty expressed therein.

Except as expressly indicated in writing, Vishay products are not designed for use in medical, life-saving, or life-sustaining applications or for any other application in which the failure of the Vishay product could result in personal injury or death. Customers using or selling Vishay products not expressly indicated for use in such applications do so at their own risk. Please contact authorized Vishay personnel to obtain written terms and conditions regarding products designed for such applications.

No license, express or implied, by estoppel or otherwise, to any intellectual property rights is granted by this document or by any conduct of Vishay. Product names and markings noted herein may be trademarks of their respective owners.

Material Category Policy

Vishay Intertechnology, Inc. hereby certifies that all its products that are identified as RoHS-Compliant fulfill the definitions and restrictions defined under Directive 2011/65/EU of The European Parliament and of the Council of June 8, 2011 on the restriction of the use of certain hazardous substances in electrical and electronic equipment (EEE) - recast, unless otherwise specified as non-compliant.

Please note that some Vishay documentation may still make reference to RoHS Directive 2002/95/EC. We confirm that all the products identified as being compliant to Directive 2002/95/EC conform to Directive 2011/65/EU.

Vishay Intertechnology, Inc. hereby certifies that all its products that are identified as Halogen-Free follow Halogen-Free requirements as per JEDEC JS709A standards. Please note that some Vishay documentation may still make reference to the IEC 61249-2-21 definition. We confirm that all the products identified as being compliant to IEC 61249-2-21 conform to JEDEC JS709A standards.

Компания «Океан Электроники» предлагает заключение долгосрочных отношений при поставках импортных электронных компонентов на взаимовыгодных условиях!

Наши преимущества:

- Поставка оригинальных импортных электронных компонентов напрямую с производств Америки, Европы и Азии, а так же с крупнейших складов мира;
- Широкая линейка поставок активных и пассивных импортных электронных компонентов (более 30 млн. наименований);
- Поставка сложных, дефицитных, либо снятых с производства позиций;
- Оперативные сроки поставки под заказ (от 5 рабочих дней);
- Экспресс доставка в любую точку России;
- Помощь Конструкторского Отдела и консультации квалифицированных инженеров;
- Техническая поддержка проекта, помощь в подборе аналогов, поставка прототипов;
- Поставка электронных компонентов под контролем ВП;
- Система менеджмента качества сертифицирована по Международному стандарту ISO 9001;
- При необходимости вся продукция военного и аэрокосмического назначения проходит испытания и сертификацию в лаборатории (по согласованию с заказчиком);
- Поставка специализированных компонентов военного и аэрокосмического уровня качества (Xilinx, Altera, Analog Devices, Intersil, Interpoint, Microsemi, Actel, Aeroflex, Peregrine, VPT, Syfer, Eurofarad, Texas Instruments, MS Kennedy, Miteq, Cobham, E2V, MA-COM, Hittite, Mini-Circuits, General Dynamics и др.);

Компания «Океан Электроники» является официальным дистрибьютором и эксклюзивным представителем в России одного из крупнейших производителей разъемов военного и аэрокосмического назначения «JONHON», а так же официальным дистрибьютором и эксклюзивным представителем в России производителя высокотехнологичных и надежных решений для передачи СВЧ сигналов «FORSTAR».



JONHON

«JONHON» (основан в 1970 г.)

Разъемы специального, военного и аэрокосмического назначения:

(Применяются в военной, авиационной, аэрокосмической, морской, железнодорожной, горно- и нефтедобывающей отраслях промышленности)

«FORSTAR» (основан в 1998 г.)

ВЧ соединители, коаксиальные кабели, кабельные сборки и микроволновые компоненты:

(Применяются в телекоммуникациях гражданского и специального назначения, в средствах связи, РЛС, а так же военной, авиационной и аэрокосмической отраслях промышленности).



Телефон: 8 (812) 309-75-97 (многоканальный)

Факс: 8 (812) 320-03-32

Электронная почта: ocean@oceanchips.ru

Web: <http://oceanchips.ru/>

Адрес: 198099, г. Санкт-Петербург, ул. Калинина, д. 2, корп. 4, лит. А