

SM10T Series Miniature SMD Crystal

March 2015



- Pletronics' SM10T Series is a miniature surface mount crystal.
- Package is ideal for automated surface mount assembly and reflow practices.
- Tape and Reel packaging
- 12 MHz to 67.5 MHz
- 2.5 x 3.2 mm 4 pad
- AT Cut Fundamental and 3rd Overtone Crystals
- Ideal for use in hand held consumer products

Pletronics Inc. certifies this device is in accordance with the RoHS 6/6 (2011/65/EC) and WEEE (2002/96/EC) directives.

Pletronics Inc. guarantees the device does not contain the following:
 Cadmium, Hexavalent Chromium, Lead, Mercury, PBB's, PBDE's
 Weight of the Device: 0.03 grams
 Moisture Sensitivity Level: 1 As defined in J-STD-020D.1
 Second Level Interconnect code: e4

Electrical Specification:

Item	Min	Max	Unit	Condition
Frequency Range	12	60	MHz	
Calibration Frequency Tolerance	10	50	ppm	at +25°C ± 3°C, see part number for options
Frequency Stability	3	150	ppm	see part number for available options
Equivalent Series Resistance (ESR)	-	120	Ohms	12 MHz to 14.318 MHz
	-	100	Ohms	14.318 MHz to 16 MHz
	-	80	Ohms	16 MHz to 20 MHz
	-	70	Ohms	20 MHz to 30 MHz
	-	50	Ohms	30 MHz to 50 MHz
	-	80	Ohms	above 50 MHz
Drive Level	-	100	μW	use 10 μW for testing
Shunt Capacitance (C0)	-	5	pF	Pad to Pad capacitance
Aging at 25°C ± 3°C	-5	+5	ppm /Yr	for the first year
	-2	+2	ppm /Yr	after the first year
Operating Temperature Range	-40	+125	°C	see part number for available options
Storage Temperature Range	-55	+125	°C	

AT Cut Crystal Frequency versus Temperature Typical Performance:

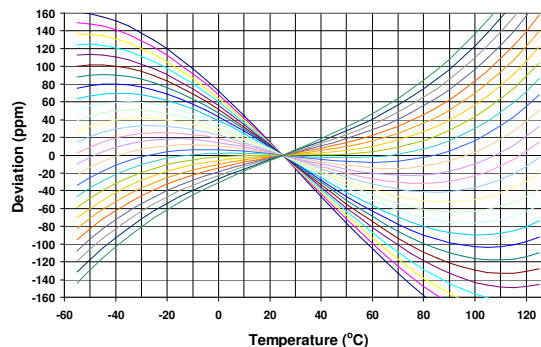

Product information is current as of publication date. The product conforms to specifications per the terms of the Pletronics standard warranty. Production processing does not necessarily include testing of all parameters.

Copyright © 2009, Pletronics Inc.

Part Number:

SM10T -18 -16.384M -20 E 1 L K -XX

See chart below for available options

Internal code or blank
Highest Specified Operating Temperature A = 40°C G = 70°C N = 100°C B = 45°C H = 75°C P = 105°C C = 50°C J = 80°C R = 110°C D = 55°C K = 85°C S = 115°C E = 60°C L = 90°C T = 120°C F = 65°C M = 95°C U = 125°C
Lowest Specified Operating Temperature A = +10°C F = -15°C L = -40°C B = +5°C G = -20°C M = -45°C C = 0°C H = -25°C N = -50°C D = -5°C J = -30°C P = -55°C E = -10°C K = -35°C
Fundamental mode AT cut crystal 1 = Fundamental AT cut crystal 3 = 3rd Overtone AT cut crystal
Frequency Stability See chart below
Calibration Frequency Tolerance (Typ. Values shown) 10 = ± 10 ppm at 25°C ± 3°C 20 = ± 20 ppm at 25°C ± 3°C 30 = ± 30 ppm at 25°C ± 3°C (Standard) 50 = ± 50 ppm at 25°C ± 3°C
Frequency in MHZ
Load in pF Parallel Resonance from 06 to 32 pF or SR = Series Resonance
Model Number

Operating Temperature Range	CODE	Available Frequency Stability versus Temperature in ppm									
		A	B	C	D	E	F	G	H	J	K
		± 3.0	± 5.0	± 8.0	± 10	± 15	± 20	± 30	± 50	± 100	± 150
0 to +45°C	CB	•	•	•	•	•	•	•	•	•	•
0 to +50°C	CC	•	•	•	•	•	•	•	•	•	•
0 to +60°C	CE		•	•	•	•	•	•	•	•	•
0 to +70°C	CG		•	•	•	•	•	•	STD	•	•
-10 to +50°C	EC		•	•	•	•	•	•	•	•	•
-10 to +60°C	EE		•	•	•	•	•	•	•	•	•
-10 to +75°C	EH			•	•	•	•	•	•	•	•
-20 to +70°C	GG			•	•	•	•	•	•	•	•
-20 to +75°C	GH				•	•	•	•	•	•	•
-30 to +75°C	JH				•	•	•	•	•	•	•
-30 to +80°C	JJ				•	•	•	•	•	•	•
-30 to +85°C	JK					•	•	•	•	•	•
-35 to +80°C	KJ					•	•	•	•	•	•
-40 to +85°C	LK					•	•	•	•	•	•
-40 to +90°C	LL					•	•	•	•	•	•
-40 to +105°C	LP						•	•	•	•	•
-40 to +125°C	LU								•	•	•

Legacy Part Number (not for new designs):

SM10T	B	E	-18	-23.45M	-XX	
						Internal code or blank
						Frequency in MHz
						Load in pF Parallel Resonance from 6 to 32 pF or SR = Series Resonance
						Operating Temperature Range Blank = 0 to +70°C (STD) E = -40 to +85°C
						Calibration Tolerance / Frequency Stability Blank = 30/50 (STD) B = 30/30
						Series Model

Reliability: Environmental Compliance

Parameter	Condition
Mechanical Shock	MIL-STD-883 Method 2002, Condition B
Vibration	MIL-STD-883 Method 2007, Condition A
Solderability	MIL-STD-883 Method 2003
Thermal Shock	MIL-STD-883 Method 1011, Condition A

Package Labeling

Label is 1" x 2.6" (25.4mm x 66.7mm)
 Font is Courier New
 Bar code is 39-Full ASCII

Label is 1" x 2.6" (25.4mm x 66.7mm)
 Font is Arial

P/N:	
	SM10T-16-23.45M-10F1CG
Customer P/N:	
	12345678
Qty:	
	1000
D/C:	
	0526

RoHS Compliant
2nd LvL Interconnect
Category=e4
Max Safe Temp=260C for 10s 2X Max

Mechanical:



	Inches	mm
A	0.098 ± 0.004	2.5 ± 0.15
B	0.126 ± 0.004	3.2 ± 0.15
C	0.028 max	0.7 max
D ¹	0.028 to 0.031	0.7 to 0.8
E ¹	0.004	0.1
F ¹	A - (2 * (D + E))	
G ¹	0.035	0.9
H ¹	0.047	1.2
J ¹	0.004	0.1

The chamfered pad may or may not be present and may be on any pad

Contacts :

Gold 11.8 µinches 0.3 µm minimum over
Nickel 50 to 350 µinches 1.27 to 8.89 µm

Not to Scale

¹ Typical dimensions

Connection (top view):



Pad 2 and Pad 4 are common and connected to the metal cover. They are not connected to the crystal. Connected to ground is recommended

The crystal is symmetrical, there is no Pad 1 preference. The part can be rotated 180° when being assembled on the PCB and will still perform correctly.

Marking:

- P = Pletronics
- ff.ffM or ff.f = Frequency
- ymd or ym = Year Month Day or Year Month, see code below
- z = Internal information
- Orientation of marking may be mixed on the tape
- Traceability of part is lost once removed from reel



Codes for Date Code YMD

Code	3	4	5	6	7	Code	A	B	C	D	E	F	G	H	J	K	L	M
Year	2013	2014	2015	2016	2017	Month	JAN	FEB	MAR	APR	MAY	JUN	JUL	AUG	SEP	OCT	NOV	DEC

Code	1	2	3	4	5	6	7	8	9	A	B	C	D	E	F	G
Day	1	2	3	4	5	6	7	8	9	10	11	12	13	14	15	16
Code	H	J	K	L	M	N	P	R	T	U	V	W	X	Y	Z	
Day	17	18	19	20	21	22	23	24	25	26	27	28	29	30	31	

Reflow Cycle (typical for lead free processing)



The part may be reflowed 2 times without degradation.

Allowed rate of temperature change
Maximum 4°C per second

Tape and Reel: available for quantities of 250 to 3000 per reel (<1000 will be cut tape)

Constant Dimensions Table 1								
Tape Size	D0	D1 Min	E1	P0	P2	S1 Min	T Max	T1 Max
8mm	1.5	1.0	1.75	4.0	2.0 ±0.05	0.6	0.25	0.1
12mm		1.5			2.0 ±0.1			
16mm		+0.1 -0.0			1.5			
24mm		1.5			1.5			

Variable Dimensions Table 2							
Tape Size	B1 Max	E2 Min	F	P1	T2 Max	W Max	Ao, Bo & Ko
8 mm	3.5	6.4	1.7 ±0.1	4.0 ±0.1	1.0	8.9	Note 1

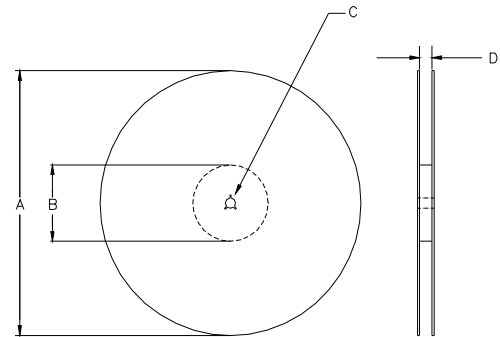

Note 1: Embossed cavity to conform to EIA-481-B Dimensions in mm Not to scale

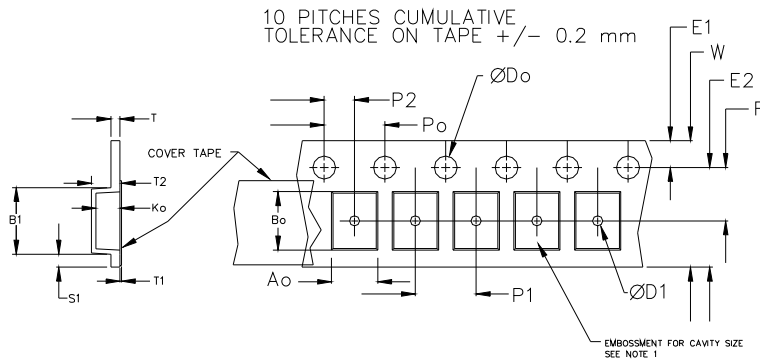

		REEL DIMENSIONS			Tape Width
A	inches	7.0	10.0	13.0	
	mm	177.8	254.0	330.2	
B	inches	2.50	4.00	3.75	
	mm	63.5	101.6	95.3	
C	mm	13.0 +0.5 / -0.2			
D	mm	8.4 +2.0 -0.0	8.4 +2.0 -0.0	8.4 +2.0 -0.0	8.0

USER DIRECTION OF UNREELING →

Reel dimensions may vary from the above

IMPORTANT NOTICE

Pletronics Incorporated (PLE) reserves the right to make corrections, improvements, modifications and other changes to this product at anytime. PLE reserves the right to discontinue any product or service without notice. Customers are responsible for obtaining the latest relevant information before placing orders and should verify that such information is current and complete. All products are sold subject to PLE's terms and conditions of sale supplied at the time of order acknowledgment.

PLE warrants performance of this product to the specifications applicable at the time of sale in accordance with PLE's limited warranty. Testing and other quality control techniques are used to the extent PLE deems necessary to support this warranty. Except where mandated by specific contractual documents, testing of all parameters of each product is not necessarily performed.

PLE assumes no liability for application assistance or customer product design. Customers are responsible for their products and applications using PLE components. To minimize the risks associated with the customer products and applications, customers should provide adequate design and operating safeguards.

PLE products are not designed, intended, authorized or warranted to be suitable for use in life support applications, devices or systems or other critical applications that may involve potential risks of death, personal injury or severe property or environmental damage. Inclusion of PLE products in such applications is understood to be fully at the risk of the customer. Use of PLE products in such applications requires the written approval of an appropriate PLE officer. Questions concerning potential risk applications should be directed to PLE.

PLE does not warrant or represent that any license, either express or implied, is granted under any PLE patent right, copyright, artwork or other intellectual property right relating to any combination, machine or process which PLE product or services are used. Information published by PLE regarding third-party products or services does not constitute a license from PLE to use such products or services or a warranty or endorsement thereof. Use of such information may require a license from a third party under the patents or other intellectual property of the third party, or a license from PLE under the patents or other intellectual property of PLE.

Reproduction of information in PLE data sheets or web site is permissible only if the reproduction is without alteration and is accompanied by associated warranties, conditions, limitations and notices. Reproduction of this information with alteration is an unfair and deceptive business practice. PLE is not responsible or liable for such altered documents.

Resale of PLE products or services with statements different from or beyond the parameters stated by PLE for that product or service voids all express and implied warranties for the associated PLE product or service and is an unfair or deceptive business practice. PLE is not responsible for any such statements.

Contacting Pletronics Inc.

Pletronics Inc.
19013 36th Ave. West
Lynnwood, WA 98036-5761 USA

Tel: 425-776-1880
Fax: 425-776-2760
E-mail: ple-sales@pletronics.com
URL: www.pletronics.com

Copyright © 2006, 2007, 2008, 2009 Pletronics Inc.

Компания «Океан Электроники» предлагает заключение долгосрочных отношений при поставках импортных электронных компонентов на взаимовыгодных условиях!

Наши преимущества:

- Поставка оригинальных импортных электронных компонентов напрямую с производств Америки, Европы и Азии, а так же с крупнейших складов мира;
- Широкая линейка поставок активных и пассивных импортных электронных компонентов (более 30 млн. наименований);
- Поставка сложных, дефицитных, либо снятых с производства позиций;
- Оперативные сроки поставки под заказ (от 5 рабочих дней);
- Экспресс доставка в любую точку России;
- Помощь Конструкторского Отдела и консультации квалифицированных инженеров;
- Техническая поддержка проекта, помощь в подборе аналогов, поставка прототипов;
- Поставка электронных компонентов под контролем ВП;
- Система менеджмента качества сертифицирована по Международному стандарту ISO 9001;
- При необходимости вся продукция военного и аэрокосмического назначения проходит испытания и сертификацию в лаборатории (по согласованию с заказчиком);
- Поставка специализированных компонентов военного и аэрокосмического уровня качества (Xilinx, Altera, Analog Devices, Intersil, Interpoint, Microsemi, Actel, Aeroflex, Peregrine, VPT, Syfer, Eurofarad, Texas Instruments, MS Kennedy, Miteq, Cobham, E2V, MA-COM, Hittite, Mini-Circuits, General Dynamics и др.);

Компания «Океан Электроники» является официальным дистрибьютором и эксклюзивным представителем в России одного из крупнейших производителей разъемов военного и аэрокосмического назначения «JONHON», а так же официальным дистрибьютором и эксклюзивным представителем в России производителя высокотехнологичных и надежных решений для передачи СВЧ сигналов «FORSTAR».



JONHON

«JONHON» (основан в 1970 г.)

Разъемы специального, военного и аэрокосмического назначения:

(Применяются в военной, авиационной, аэрокосмической, морской, железнодорожной, горно- и нефтедобывающей отраслях промышленности)

«FORSTAR» (основан в 1998 г.)

ВЧ соединители, коаксиальные кабели, кабельные сборки и микроволновые компоненты:

(Применяются в телекоммуникациях гражданского и специального назначения, в средствах связи, РЛС, а так же военной, авиационной и аэрокосмической отраслях промышленности).



Телефон: 8 (812) 309-75-97 (многоканальный)

Факс: 8 (812) 320-03-32

Электронная почта: ocean@oceanchips.ru

Web: <http://oceanchips.ru/>

Адрес: 198099, г. Санкт-Петербург, ул. Калинина, д. 2, корп. 4, лит. А