

# MC74VHC1G01

## Single 2-Input NAND Gate with Open Drain Output

The MC74VHC1G01 is an advanced high speed CMOS 2-input NAND gate with an open drain output fabricated with silicon gate CMOS technology.

The internal circuit is composed of multiple stages, including an open drain output which provides the ability to set output switching level. This allows the MC74VHC1G01 to be used to interface 5 V circuits to circuits of any voltage between  $V_{CC}$  and 7 V using an external resistor and power supply.

The MC74VHC1G01 input structure provides protection when voltages up to 7 V are applied, regardless of the supply voltage.

### Features

- High Speed:  $t_{PD} = 3.7$  ns (Typ) at  $V_{CC} = 5$  V
- Low Internal Power Dissipation:  $I_{CC} = 1$   $\mu$ A (Max) at  $T_A = 25^\circ$ C
- Power Down Protection Provided on Inputs
- Pin and Function Compatible with Other Standard Logic Families
- Chip Complexity: FETs = 62
- Pb-Free Packages are Available

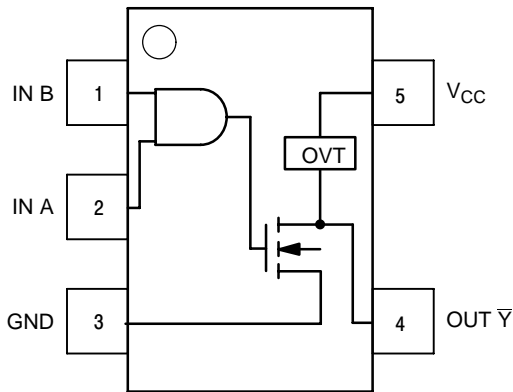

Figure 1. Pinout (Top View)

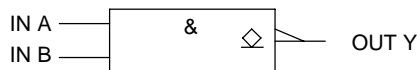

Figure 2. Logic Symbol



ON Semiconductor®

<http://onsemi.com>

### MARKING DIAGRAMS

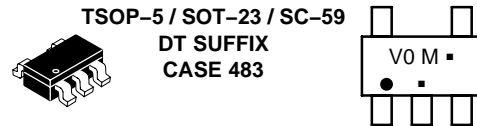
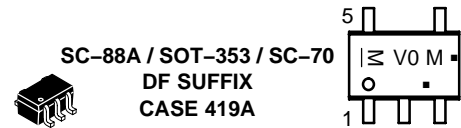

V0 = Device Code  
M = Date Code\*  
▪ = Pb-Free Package

(Note: Microdot may be in either location)

\*Date Code orientation and/or position may vary depending upon manufacturing location.

### PIN ASSIGNMENT

Pin	Function
1	IN B
2	IN A
3	GND
4	OUT $\bar{Y}$
5	$V_{CC}$

### FUNCTION TABLE

Inputs		Output
A	B	$\bar{Y}$
L	L	Z
L	H	Z
H	L	Z
H	H	L

### ORDERING INFORMATION

See detailed ordering and shipping information in the package dimensions section on page 4 of this data sheet.

# MC74VHC1G01

## MAXIMUM RATINGS

Symbol	Parameter	Value	Unit
V <sub>CC</sub>	DC Supply Voltage	-0.5 to +7.0	V
V <sub>IN</sub>	DC Input Voltage	-0.5 to +7.0	V
V <sub>OUT</sub>	DC Output Voltage	-0.5 to V <sub>CC</sub> + 0.5	V
I <sub>IK</sub>	DC Input Diode Current	-20	mA
I <sub>OK</sub>	DC Output Diode Current	V <sub>OUT</sub> < GND; V <sub>OUT</sub> > V <sub>CC</sub>	±20
I <sub>OUT</sub>	DC Output Sink Current, per Pin	25	mA
I <sub>CC</sub>	DC Supply Current, V <sub>CC</sub> and GND Pin	±25	mA
T <sub>STG</sub>	Storage Temperature Range	-65 to +150	°C
T <sub>L</sub>	Lead Temperature, 1 mm from Case for 10 Seconds	260	°C
T <sub>J</sub>	Junction Temperature Under Bias	+150	°C
θ <sub>JA</sub>	Thermal Resistance	SC70-5/SC-88A (Note 1) TSOP-5	350 230
P <sub>D</sub>	Power Dissipation in Still Air at 85°C	SC70-5/SC-88A TSOP-5	150 200
MSL	Moisture Sensitivity	Level 1	
F <sub>R</sub>	Flammability Rating	Oxygen Index: 28 to 34	UL 94 V-0 @ 0.125 in
V <sub>ESD</sub>	ESD Withstand Voltage	Human Body Model (Note 2) Machine Model (Note 3) Charged Device Model (Note 4)	>2000 >200 N/A
I <sub>LATCHUP</sub>	Latchup Performance	Above V <sub>CC</sub> and Below GND at 125°C (Note 5)	±500

Stresses exceeding Maximum Ratings may damage the device. Maximum Ratings are stress ratings only. Functional operation above the Recommended Operating Conditions is not implied. Extended exposure to stresses above the Recommended Operating Conditions may affect device reliability.

1. Measured with minimum pad spacing on an FR4 board, using 10 mm-by-1 inch, 2-ounce copper trace with no air flow.
2. Tested to EIA/JESD22-A114-A.
3. Tested to EIA/JESD22-A115-A.
4. Tested to JESD22-C101-A.
5. Tested to EIA/JESD78.

## RECOMMENDED OPERATING CONDITIONS

Symbol	Characteristics	Min	Max	Unit
V <sub>CC</sub>	DC Supply Voltage	2.0	5.5	V
V <sub>IN</sub>	DC Input Voltage	0.0	5.5	V
V <sub>OUT</sub>	DC Output Voltage	0.0	7.0	V
T <sub>A</sub>	Operating Temperature Range	-55	+125	°C
t <sub>r</sub> , t <sub>f</sub>	Input Rise and Fall Time V <sub>CC</sub> = 3.3 V ± 0.3 V V <sub>CC</sub> = 5.0 V ± 0.5 V	0 0	100 20	ns/V

## DEVICE JUNCTION TEMPERATURE VERSUS TIME TO 0.1% BOND FAILURES

Junction Temperature °C	Time, Hours	Time, Years
80	1,032,200	117.8
90	419,300	47.9
100	178,700	20.4
110	79,600	9.4
120	37,000	4.2
130	17,800	2.0
140	8,900	1.0

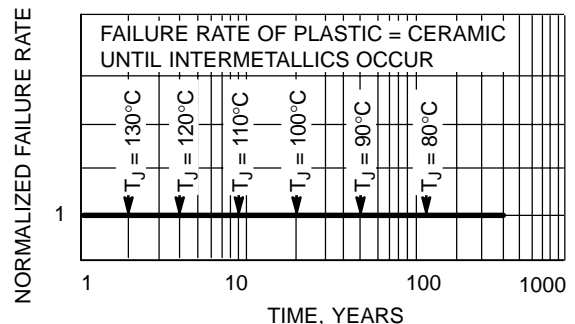

Figure 3. Failure Rate vs. Time Junction Temperature

# MC74VHC1G01

## DC ELECTRICAL CHARACTERISTICS

Symbol	Parameter	Test Conditions	V <sub>CC</sub> (V)	T <sub>A</sub> = 25°C			T <sub>A</sub> ≤ 85°C		-55°C ≤ T <sub>A</sub> ≤ 125°C		Unit
				Min	Typ	Max	Min	Max	Min	Max	
V <sub>IH</sub>	Minimum High-Level Input Voltage		2.0 3.0 4.5 5.5	1.5 2.1 3.15 3.85			1.5 2.1 3.15 3.85		1.5 2.1 3.15 3.85	V	
V <sub>IL</sub>	Maximum Low-Level Input Voltage		2.0 3.0 4.5 5.5			0.5 0.9 1.35 1.65		0.5 0.9 1.35 1.65		0.5 0.9 1.35 1.65	V
V <sub>OL</sub>	Maximum Low-Level Output Voltage V <sub>IN</sub> = V <sub>IH</sub> or V <sub>IL</sub>	V <sub>IN</sub> = V <sub>IH</sub> or V <sub>IL</sub> I <sub>OL</sub> = 50 μA	2.0 3.0 4.5		0.0 0.0 0.0	0.1 0.1 0.1		0.1 0.1 0.1		0.1 0.1 0.1	V
		V <sub>IN</sub> = V <sub>IH</sub> or V <sub>IL</sub> I <sub>OL</sub> = 4 mA I <sub>OL</sub> = 8 mA	3.0 4.5			0.36 0.36		0.44 0.44		0.52 0.52	
I <sub>LKG</sub>	Z-State Output Leakage Current	V <sub>IN</sub> = V <sub>IL</sub> V <sub>OUT</sub> = V <sub>CC</sub> or GND	5.5			±5		±10		±10	μA
I <sub>IN</sub>	Maximum Input Leakage Current	V <sub>IN</sub> = 5.5 V or GND	0 to 5.5			±0.1		±1.0		±1.0	μA
I <sub>CC</sub>	Maximum Quiescent Supply Current	V <sub>IN</sub> = V <sub>CC</sub> or GND	5.5			1.0		20		40	μA
I <sub>OFF</sub>	Power Off-Output Leakage Current	V <sub>OUT</sub> = 5.5 V V <sub>IN</sub> = 5.5 V	0			0.25		2.5		5	μA

## AC ELECTRICAL CHARACTERISTICS Input t<sub>r</sub> = t<sub>f</sub> = 3.0 ns

Symbol	Parameter	Test Conditions	T <sub>A</sub> = 25°C			T <sub>A</sub> ≤ 85°C		-55 ≤ T <sub>A</sub> ≤ 125°C		Unit
			Min	Typ	Max	Min	Max	Min	Max	
t <sub>pZL</sub>	Maximum Output Enable Time, Input A or B to Y	V <sub>CC</sub> = 3.3 ± 0.3 V C <sub>L</sub> = 15 pF R <sub>L</sub> = R <sub>I</sub> = 500 Ω C <sub>L</sub> = 50 pF		5.5 8.0	7.9 11.4		9.5 13.0		11.0 15.5	ns
		V <sub>CC</sub> = 5.0 ± 0.5 V C <sub>L</sub> = 15 pF R <sub>L</sub> = R <sub>I</sub> = 500 Ω C <sub>L</sub> = 50 pF		3.7 5.2	5.5 7.5		6.5 8.5		8.0 10.0	
t <sub>pLZ</sub>	Maximum Output Disable Time	V <sub>CC</sub> = 3.3 ± 0.3 V C <sub>L</sub> = 50 pF R <sub>L</sub> = R <sub>I</sub> = 500 Ω		8.0	11.4		13.0		15.5	ns
		V <sub>CC</sub> = 5.0 ± 0.5 V C <sub>L</sub> = 50 pF R <sub>L</sub> = R <sub>I</sub> = 500 Ω		5.2	7.5		8.5		10.0	
C <sub>IN</sub>	Maximum Input Capacitance			4	10		10		10	pF

C <sub>PD</sub>	Power Dissipation Capacitance (Note 6)	<b>Typical @ 25°C, V<sub>CC</sub> = 5.0V</b>	pF
		18	

6. C<sub>PD</sub> is defined as the value of the internal equivalent capacitance which is calculated from the operating current consumption without load. Average operating current can be obtained by the equation: I<sub>CC(OPR)</sub> = C<sub>PD</sub> • V<sub>CC</sub> • f<sub>in</sub> + I<sub>CC</sub>. C<sub>PD</sub> is used to determine the no-load dynamic power consumption; P<sub>D</sub> = C<sub>PD</sub> • V<sub>CC</sub><sup>2</sup> • f<sub>in</sub> + I<sub>CC</sub> • V<sub>CC</sub>.

# MC74VHC1G01

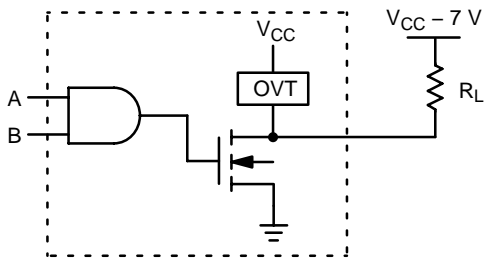

Figure 4. Output Voltage Mismatch Application

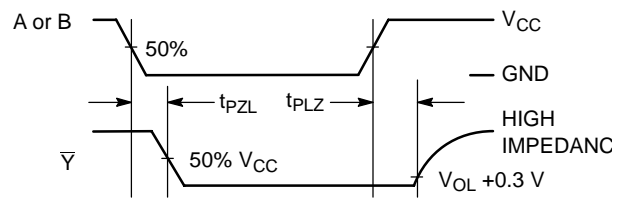
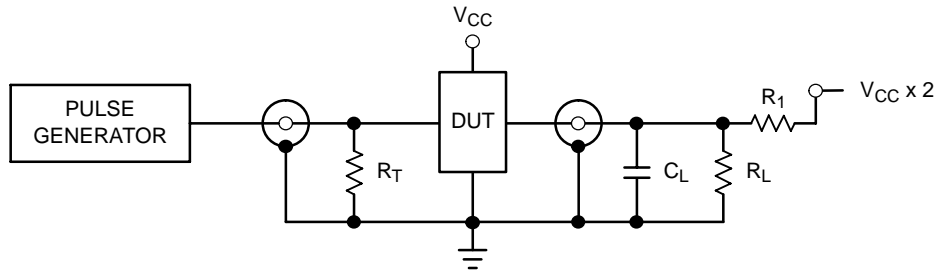
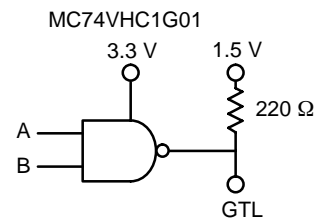
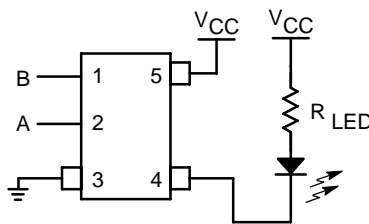
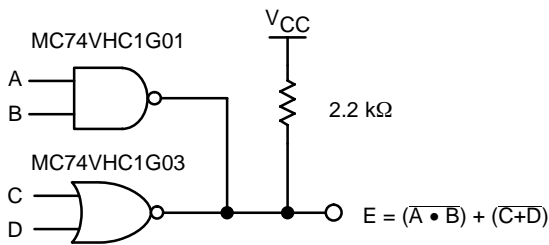

Figure 5. Switching Waveforms



$C_L = 50 \text{ pF}$  equivalent (Includes jig and probe capacitance)  
 $R_L = R_1 = 500 \Omega$  or equivalent  
 $R_T = Z_{OUT}$  of pulse generator (typically  $50 \Omega$ )

Figure 6. Test Circuit



## ORDERING INFORMATION

Device	Package	Shipping†
MC74VHC1G01DFT1	SC70-5 / SC-88A / SOT-353	3000 Units / Tape & Reel
MC74VHC1G01DFT1G	SC70-5 / SC-88A / SOT-353 (Pb-Free)	
MC74VHC1G01DFT2	SC70-5 / SC-88A / SOT-353	
MC74VHC1G01DFT2G	SC70-5 / SC-88A / SOT-353 (Pb-Free)	
MC74VHC1G01DTT1	SOT23-5 / TSSOP-5 / SC59-5	
MC74VHC1G01DTT1G	SOT23-5 / TSSOP-5 / SC59-5 (Pb-Free)	

†For information on tape and reel specifications, including part orientation and tape sizes, please refer to our Tape and Reel Packaging Specifications Brochure, BRD8011/D.

# MC74VHC1G01

## PACKAGE DIMENSIONS

SC-88A, SOT-353, SC-70  
CASE 419A-02  
ISSUE J

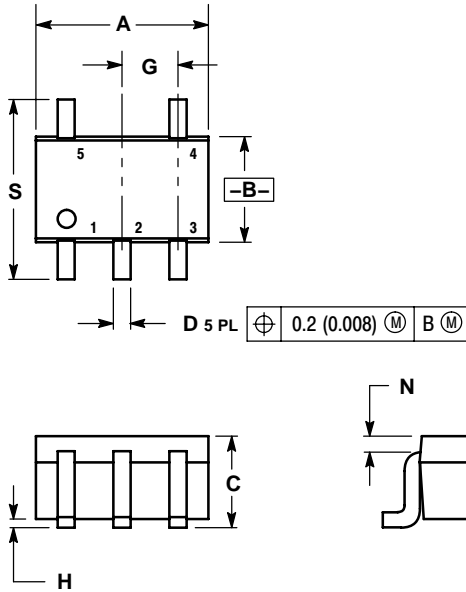

NOTES:

1. DIMENSIONING AND TOLERANCING PER ANSI Y14.5M, 1982.
2. CONTROLLING DIMENSION: INCH.
3. 419A-01 OBSOLETE. NEW STANDARD 419A-02.
4. DIMENSIONS A AND B DO NOT INCLUDE MOLD FLASH, PROTRUSIONS, OR GATE BURRS.

DIM	INCHES		MILLIMETERS	
	MIN	MAX	MIN	MAX
A	0.071	0.087	1.80	2.20
B	0.045	0.053	1.15	1.35
C	0.031	0.043	0.80	1.10
D	0.004	0.012	0.10	0.30
G	0.026 BSC		0.65 BSC	
H	---	0.004	---	0.10
J	0.004	0.010	0.10	0.25
K	0.004	0.012	0.10	0.30
N	0.008 REF		0.20 REF	
S	0.079	0.087	2.00	2.20

### SOLDERING FOOTPRINT\*

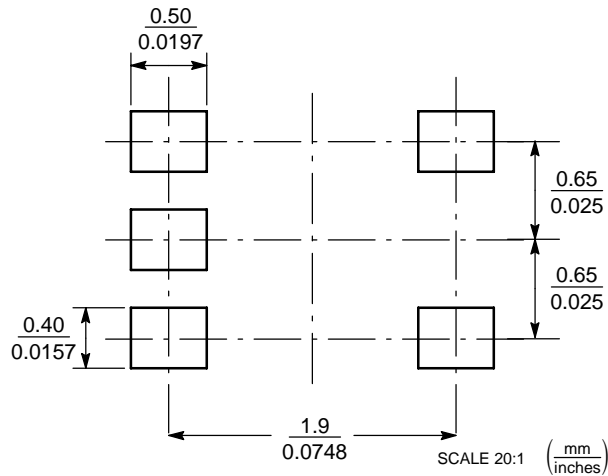

\*For additional information on our Pb-Free strategy and soldering details, please download the ON Semiconductor Soldering and Mounting Techniques Reference Manual, SOLDERRM/D.

# MC74VHC1G01

## PACKAGE DIMENSIONS

TSOP-5  
CASE 483-02  
ISSUE F

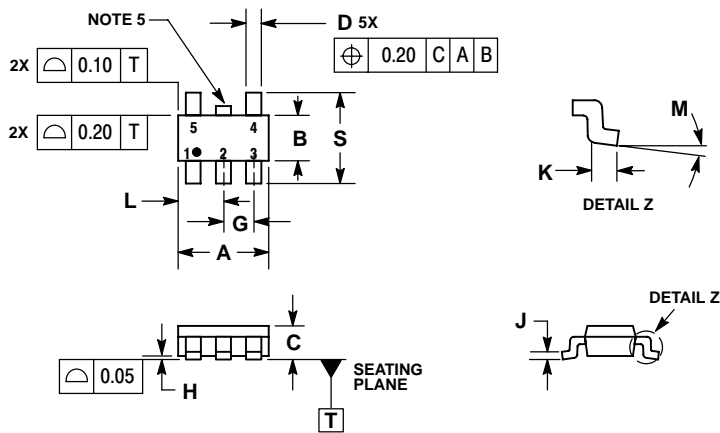

**NOTES:**

1. DIMENSIONING AND TOLERANCING PER ASME Y14.5M, 1994.
2. CONTROLLING DIMENSION: MILLIMETERS.
3. MAXIMUM LEAD THICKNESS INCLUDES LEAD FINISH THICKNESS. MINIMUM LEAD THICKNESS IS THE MINIMUM THICKNESS OF BASE MATERIAL.
4. DIMENSIONS A AND B DO NOT INCLUDE MOLD FLASH, PROTRUSIONS, OR GATE BURRS.
5. OPTIONAL CONSTRUCTION: AN ADDITIONAL TRIMMED LEAD IS ALLOWED IN THIS LOCATION. TRIMMED LEAD NOT TO EXTEND MORE THAN 0.2 FROM BODY.

DIM	MILLIMETERS	
	MIN	MAX
A	3.00 BSC	
B	1.50 BSC	
C	0.90	1.10
D	0.25	0.50
G	0.95 BSC	
H	0.01	0.10
J	0.10	0.26
K	0.20	0.60
L	1.25	1.55
M	0°	10°
S	2.50	3.00

### SOLDERING FOOTPRINT\*

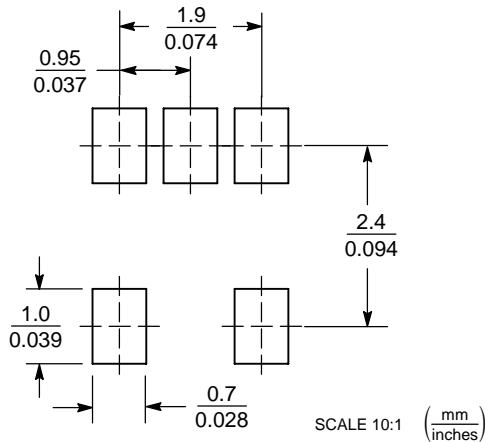

\*For additional information on our Pb-Free strategy and soldering details, please download the ON Semiconductor Soldering and Mounting Techniques Reference Manual, SOLDERRM/D.

ON Semiconductor and are registered trademarks of Semiconductor Components Industries, LLC (SCILLC). SCILLC reserves the right to make changes without further notice to any products herein. SCILLC makes no warranty, representation or guarantee regarding the suitability of its products for any particular purpose, nor does SCILLC assume any liability arising out of the application or use of any product or circuit, and specifically disclaims any and all liability, including without limitation special, consequential or incidental damages. "Typical" parameters which may be provided in SCILLC data sheets and/or specifications can and do vary in different applications and actual performance may vary over time. All operating parameters, including "Typicals" must be validated for each customer application by customer's technical experts. SCILLC does not convey any license under its patent rights nor the rights of others. SCILLC products are not designed, intended, or authorized for use as components in systems intended for surgical implant into the body, or other applications intended to support or sustain life, or for any other application in which the failure of the SCILLC product could create a situation where personal injury or death may occur. Should Buyer purchase or use SCILLC products for any such unintended or unauthorized application, Buyer shall indemnify and hold SCILLC and its officers, employees, subsidiaries, affiliates, and distributors harmless against all claims, costs, damages, and expenses, and reasonable attorney fees arising out of, directly or indirectly, any claim of personal injury or death associated with such unintended or unauthorized use, even if such claim alleges that SCILLC was negligent regarding the design or manufacture of the part. SCILLC is an Equal Opportunity/Affirmative Action Employer. This literature is subject to all applicable copyright laws and is not for resale in any manner.

### PUBLICATION ORDERING INFORMATION

**LITERATURE FULFILLMENT:**  
Literature Distribution Center for ON Semiconductor  
P.O. Box 5163, Denver, Colorado 80217 USA  
Phone: 303-675-2175 or 800-344-3860 Toll Free USA/Canada  
Fax: 303-675-2176 or 800-344-3867 Toll Free USA/Canada  
Email: orderlit@onsemi.com

**N. American Technical Support:** 800-282-9855 Toll Free  
USA/Canada  
**Europe, Middle East and Africa Technical Support:**  
Phone: 421 33 790 2910  
**Japan Customer Focus Center**  
Phone: 81-3-5773-3850

**ON Semiconductor Website:** [www.onsemi.com](http://www.onsemi.com)  
**Order Literature:** <http://www.onsemi.com/orderlit>

For additional information, please contact your local Sales Representative

Компания «Океан Электроники» предлагает заключение долгосрочных отношений при поставках импортных электронных компонентов на взаимовыгодных условиях!

Наши преимущества:

- Поставка оригинальных импортных электронных компонентов напрямую с производств Америки, Европы и Азии, а так же с крупнейших складов мира;
- Широкая линейка поставок активных и пассивных импортных электронных компонентов (более 30 млн. наименований);
- Поставка сложных, дефицитных, либо снятых с производства позиций;
- Оперативные сроки поставки под заказ (от 5 рабочих дней);
- Экспресс доставка в любую точку России;
- Помощь Конструкторского Отдела и консультации квалифицированных инженеров;
- Техническая поддержка проекта, помощь в подборе аналогов, поставка прототипов;
- Поставка электронных компонентов под контролем ВП;
- Система менеджмента качества сертифицирована по Международному стандарту ISO 9001;
- При необходимости вся продукция военного и аэрокосмического назначения проходит испытания и сертификацию в лаборатории (по согласованию с заказчиком);
- Поставка специализированных компонентов военного и аэрокосмического уровня качества (Xilinx, Altera, Analog Devices, Intersil, Interpoint, Microsemi, Actel, Aeroflex, Peregrine, VPT, Syfer, Eurofarad, Texas Instruments, MS Kennedy, Miteq, Cobham, E2V, MA-COM, Hittite, Mini-Circuits, General Dynamics и др.);

Компания «Океан Электроники» является официальным дистрибьютором и эксклюзивным представителем в России одного из крупнейших производителей разъемов военного и аэрокосмического назначения «JONHON», а так же официальным дистрибьютором и эксклюзивным представителем в России производителя высокотехнологичных и надежных решений для передачи СВЧ сигналов «FORSTAR».



## JONHON

«JONHON» (основан в 1970 г.)

Разъемы специального, военного и аэрокосмического назначения:

(Применяются в военной, авиационной, аэрокосмической, морской, железнодорожной, горно- и нефтедобывающей отраслях промышленности)

«FORSTAR» (основан в 1998 г.)

ВЧ соединители, коаксиальные кабели,  
кабельные сборки и микроволновые компоненты:

(Применяются в телекоммуникациях гражданского и специального назначения, в средствах связи, РЛС, а так же военной, авиационной и аэрокосмической отраслях промышленности).



Телефон: 8 (812) 309-75-97 (многоканальный)

Факс: 8 (812) 320-03-32

Электронная почта: [ocean@oceanchips.ru](mailto:ocean@oceanchips.ru)

Web: <http://oceanchips.ru/>

Адрес: 198099, г. Санкт-Петербург, ул. Калинина, д. 2, корп. 4, лит. А