



Low-Cost, +3V/+5V, 620 μ A, 200MHz, Single-Supply Op Amps with Rail-to-Rail Outputs

General Description

The MAX4452/MAX4352 single, MAX4453/MAX4353 dual, and MAX4454/MAX4354 quad amplifiers combine high-speed performance with ultra-low power consumption. The MAX4452/MAX4453/MAX4454 are unity-gain stable and achieve a -3dB bandwidth of 200MHz, while the MAX4352/MAX4353/MAX4354 are compensated for a minimum closed-loop gain of +5V/V and achieve a 80MHz -3dB bandwidth. These devices consume only 620 μ A of supply current per amplifier.

These amplifiers operate from a +2.7V to +5.25V single supply and feature rail-to-rail outputs. Along with an excellent speed/power ratio of 323MHz/mA, these devices feature a slew rate of 95V/ μ s and fast 20ns rise and fall times. These devices are ideal for low-power/low-voltage systems that require wide bandwidth such as cell phones and keyless entry systems.

The MAX4452/MAX4352 are available in miniature 5-pin SC70 and SOT23 packages, while the MAX4453/MAX4353 are available in tiny 8-pin SOT23, Thin SOT23, and SO packages. The MAX4454/MAX4354 are available in space-saving 14-pin TSSOP and SO packages.

Applications

Battery-Powered Instruments
Cellular Telephones
Portable Communications
Keyless Entry
Baseband Applications

Typical Operating Characteristic

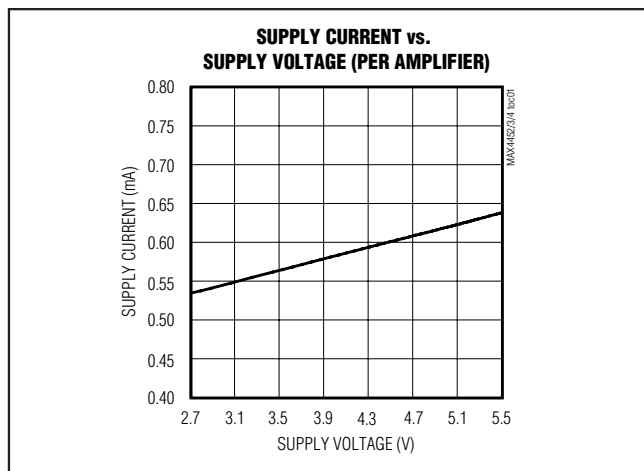

Features

- ◆ Ultra-Low 620 μ A Supply Current
- ◆ High Speed (MAX4452/MAX4453/MAX4454)
200MHz -3dB Bandwidth
30MHz 0.1dB Gain Flatness
95V/ μ s Slew Rate
- ◆ High Speed (MAX4352/MAX4353/MAX4354)
80MHz -3dB Bandwidth
4MHz 0.1dB Gain Flatness
240V/ μ s Slew Rate
- ◆ Single +3V/+5V Operation
- ◆ Rail-to-Rail Outputs
- ◆ Ultra-Small SC70-5, SOT23-5, SOT23-8 and Thin SOT23-8 Packages

Ordering Information

PART	TEMP RANGE	PIN-PACKAGE	TOP MARK
MAX4452EXK-T	-40°C to +85°C	5 SC70-5	ABI
MAX4452EUK-T	-40°C to +85°C	5 SOT23-5	ADOV
MAX4453EKA-T	-40°C to +85°C	8 SOT23-8	AADS
MAX4453EZA-T	-40°C to +85°C	8 Thin SOT23-8	AAAB
MAX4453ESA	-40°C to +85°C	8 SO	—
MAX4454EUD	-40°C to +85°C	14 TSSOP	—
MAX4454ESD	-40°C to +85°C	14 SO	—
MAX4352EXK-T	-40°C to +85°C	5 SC70-5	ABJ
MAX4352EUK-T	-40°C to +85°C	5 SOT23-5	ADOW
MAX4353EKA-T	-40°C to +85°C	8 SOT23-8	AADT
MAX4353ESA	-40°C to +85°C	8 SO	—
MAX4354EUD	-40°C to +85°C	14 TSSOP	—
MAX4354ESD	-40°C to +85°C	14 SO	—

Pin Configurations appear at end of data sheet.

Selector Guide

PART	NO. OF AMPS	MIN GAIN	GAIN BANDWIDTH (MHz)	SLEW RATE (V/ μ s)
MAX4452	1	1	200	95
MAX4352	1	5	400	240
MAX4453	2	1	200	95
MAX4353	2	5	400	240
MAX4454	4	1	200	95
MAX4354	4	5	400	240



Low-Cost, +3V/+5V, 620µA, 200MHz, Single-Supply Op Amps with Rail-to-Rail Outputs

ABSOLUTE MAXIMUM RATINGS

Supply Voltage (V _{CC} to V _{EE}).....	+6V	8-Pin Thin SOT23 (derate 6.3mW/°C above +70°C).....	500mW
Differential Input Voltage	2.5V	8-Pin SO (derate 5.9mW/°C above +70°C).....	471mW
IN ₋ , IN ₊ , OUT ₋(V _{CC} + 0.3V) to (V _{EE} - 0.3V)		14-Pin TSSOP (derate 6.3mW/°C above +70°C)	500mW
Current into Input Pins (IN ₊ , IN ₋)	±20mA	14-Pin SO (derate 8mW/°C above +70°C).....	640mW
Output Short-Circuit Duration to V _{CC} , V _{EE}	Continuous	Operating Temperature Range	-40°C to +85°C
Continuous Power Dissipation (T _A = +70°C)		Junction Temperature	+150°C
5-Pin SC70 (derate 3.1mW/°C above +70°C).....	247mW	Storage Temperature Range	-65°C to +150°C
5 Pin SOT23 (derate 7.1mW/°C above +70°C).....	571mW	Lead Temperature (soldering, 10s)	+300°C
8-Pin SOT23 (derate 8.9mW/°C above +70°C).....	741mW		

Stresses beyond those listed under "Absolute Maximum Ratings" may cause permanent damage to the device. These are stress ratings only, and functional operation of the device at these or any other conditions beyond those indicated in the operational sections of the specifications is not implied. Exposure to absolute maximum rating conditions for extended periods may affect device reliability.

DC ELECTRICAL CHARACTERISTICS

(V_{CC} = +5V, V_{CM} = V_{CC}/2 - 0.75V, V_{EE} = 0, R_L = ∞ to V_{CC}/2, V_{OUT} = V_{CC}/2, T_A = T_{MIN} to T_{MAX}, unless otherwise noted. Typical values are at T_A = +25°C.) (Note 1)

PARAMETER	SYMBOL	CONDITIONS	MIN	TYP	MAX	UNITS
Operating Supply Voltage Range	V _S	Guaranteed by PSRR test	2.7		5.25	V
Quiescent Supply Current (Per Amplifier)	I _S	V _{CC} = +5V		620	1200	µA
		V _{CC} = +3V		530		
Input Common-Mode Voltage Range	V _{CM}	Guaranteed by CMRR test	V _{EE} - 0.1		V _{CC} - 1.5	V
Input Offset Voltage	V _{OS}			0.4	12	mV
Input Offset Voltage Temperature Coefficient	TC _{VOS}			7		µV/°C
Input Offset Voltage Matching		MAX4453/MAX4454/MAX4353/MAX4354		±1		mV
Input Bias Current	I _B			0.8	3	µA
Input Offset Current	I _{OS}			0.1		µA
Input Resistance	R _{IN}	Differential mode, -0.04V ≤ (V _{IN+} - V _{IN-}) ≤ +0.04V		120		kΩ
		Common mode, V _{EE} - 0.1V ≤ V _{CM} ≤ V _{CC} - 1.5V		30		MΩ
Common-Mode Rejection Ratio	CMRR	V _{EE} - 0.1V ≤ V _{CM} ≤ V _{CC} - 1.5V	60	100		dB
Open-Loop Gain	A _{VOL}	+0.5V ≤ V _{OUT} ≤ +4.5V, R _L = 1kΩ	60	80		dB
Output Current	I _{OUT}	R _L = 20Ω connected to V _{CC} or V _{EE}	Sourcing	15		mA
			Sinking	22		
Output Voltage Swing	V _{OUT}	R _L = 1kΩ	V _{CC} - V _{OH}	180	400	mV
			V _{OL} - V _{EE}	75	350	
Output Short-Circuit Current	I _{SC}	Sourcing	17		mA	
		Sinking	24			
Power-Supply Rejection Ratio	PSRR	V _{CC} = +2.7V to +5.25V, V _{CM} = 0, V _{OUT} = 2V	60	70		dB

Low-Cost, +3V/+5V, 620 μ A, 200MHz, Single-Supply Op Amps with Rail-to-Rail Outputs

AC ELECTRICAL CHARACTERISTICS

($V_{CC} = +5V$, $V_{EE} = 0$, $V_{CM} = +1.75V$, $R_L = 1k\Omega$ to $V_{CC}/2$, $A_{VCL} = +1V/V$ (MAX4452/MAX4453/MAX4454), $A_{VCL} = +5V/V$ (MAX4352/MAX4353/MAX4354), $T_A = +25^\circ C$, unless otherwise noted.)

PARAMETER	SYMBOL	CONDITIONS		MIN	TYP	MAX	UNITS
Small Signal -3dB Bandwidth	BW _{SS}	V _{OUT} = 100mV _{p-p}	MAX4452/MAX4453/ MAX4454		200		MHz
			MAX4352/MAX4353/ MAX4354		80		
Large Signal -3dB Bandwidth	BW _{LS}	V _{OUT} = 2V _{p-p}	MAX4452/MAX4453/ MAX4454		15		MHz
			MAX4352/MAX4353/ MAX4354		38		
Bandwidth for 0.1dB Flatness	BW _{0.1dB}	V _{OUT} = 100mV _{p-p}	MAX4452/MAX4453/ MAX4454		30		MHz
			MAX4352/MAX4353/ MAX4354		4		
Slew Rate	SR	V _{OUT} = 2V step	MAX4452/MAX4453/ MAX4454		95		V/ μ s
			MAX4352/MAX4353/ MAX4354		240		
Rise/Fall Time	t _R , t _F	V _{OUT} = 2V step 10% to 90%	MAX4452/MAX4453/ MAX4454		20		ns
			MAX4352/MAX4353/ MAX4354		8		
Settling Time	t _s 1%	V _{OUT} = 2V step	MAX4452/MAX4453/ MAX4454		40		ns
			MAX4352/MAX4353/ MAX4354		50		
	t _s 0.1%	V _{OUT} = 2V step	MAX4452/MAX4453/ MAX4454		50		
			MAX4352/MAX4353/ MAX4354		60		

Low-Cost, +3V/+5V, 620 μ A, 200MHz, Single-Supply Op Amps with Rail-to-Rail Outputs

AC ELECTRICAL CHARACTERISTICS (continued)

($V_{CC} = +5V$, $V_{EE} = 0$, $V_{CM} = +1.75V$, $R_L = 1k\Omega$ to $V_{CC}/2$, $A_{VCL} = +1V/V$ (MAX4452/MAX4453/MAX4454), $A_{VCL} = +5V/V$ (MAX4352/MAX4353/MAX4354), $T_A = +25^\circ C$, unless otherwise noted.)

PARAMETER	SYMBOL	CONDITIONS		MIN	TYP	MAX	UNITS	
Spurious-Free Dynamic Range	SFDR	$V_{CC} = 5V$, $V_{OUT} = 2V_{p-p}$, $f_C = 1MHz$	MAX4452/MAX4453/ MAX4454		-83		dBc	
			MAX4352/MAX4353/ MAX4354		-74			
		$V_{CC} = 3V$, $V_{OUT} = 2V_{p-p}$, $f_C = 1MHz$	MAX4452/MAX4453/ MAX4454		-79			
			MAX4352/MAX4353/ MAX4354		-70			
2nd-Harmonic Distortion		$V_{CC} = 5V$, $V_{OUT} = 2V_{p-p}$, $f_C = 1MHz$	MAX4452/MAX4453/ MAX4454		-83		dBc	
			MAX4352/MAX4353/ MAX4354		-74			
		$V_{CC} = 3V$, $V_{OUT} = 1V_{p-p}$, $f_C = 1MHz$	MAX4452/MAX4453/ MAX4454		-79			
			MAX4352/MAX4353/ MAX4354		-70			
3rd-Harmonic Distortion		$V_{CC} = 5V$, $V_{OUT} = 2V_{p-p}$, $f_C = 1MHz$	MAX4452/MAX4453/ MAX4454		-87		dBc	
			MAX4352/MAX4353/ MAX4354		-74			
		$V_{CC} = 3V$, $V_{OUT} = 1V_{p-p}$, $f_C = 1MHz$	MAX4452/MAX4453/ MAX4454		-80			
			MAX4352/MAX4353/ MAX4354		-72			
Total Harmonic Distortion	THD	$V_{CC} = 5V$, $V_{OUT} = 2V_{p-p}$, $f_C = 1MHz$	MAX4452/MAX4453/ MAX4454		-82		dB	
			MAX4352/MAX4353/ MAX4354		-71			
		$V_{CC} = 3V$, $V_{OUT} = 1V_{p-p}$, $f_C = 1MHz$	MAX4452/MAX4453/ MAX4454		-77			
			MAX4352/MAX4353/ MAX4354		-68			

MAX4452/MAX4453/MAX4454/MAX4352/MAX4353/MAX4354

Low-Cost, +3V/+5V, 620µA, 200MHz, Single-Supply Op Amps with Rail-to-Rail Outputs

AC ELECTRICAL CHARACTERISTICS (continued)

($V_{CC} = +5V$, $V_{EE} = 0$, $V_{CM} = +1.75V$, $R_L = 1k\Omega$ to $V_{CC}/2$, $A_{VCL} = +1V/V$ (MAX4452/MAX4453/MAX4454), $A_{VCL} = +5V/V$ (MAX4352/MAX4353/MAX4354), $T_A = +25^\circ C$, unless otherwise noted.)

PARAMETER	SYMBOL	CONDITIONS	MIN	TYP	MAX	UNITS
Two-Tone, Third-Order Intermodulation Distortion		$f_1 = 2MHz$, $f_2 = 2.1MHz$		-65		dBc
Input Noise-Voltage Density	e_n	$f = 10kHz$		15		nV/ \sqrt{Hz}
Input Noise-Current Density	i_n	$f = 10kHz$		0.5		pA/ \sqrt{Hz}
Input Capacitance	C_{IN}			2		pF
Output Impedance	Z_{OUT}	$f = 1MHz$		0.8		Ω
Capacitive Load Drive				22		pF
Crosstalk	X _{TALK}	MAX4453/MAX4454/MAX4353/MAX4354 $V_{OUT} = 100mVp-p$, $f = 1MHz$		-74		dB
Power-Up 1% Settling Time (Note 2)				1	100	μs

Note 1: Units are 100% production tested at $T_A = +25^\circ C$. Specifications over temperature limits are guaranteed by design.

Note 2: Guaranteed by design.

Typical Operating Characteristics

($V_{CC} = +5V$, $V_{EE} = 0$, $V_{CM} = +1.75V$, $A_{VCL} = +1V/V$ (MAX4452/MAX4453/MAX4454), $A_{VCL} = +5V/V$ (MAX4352/MAX4353/MAX4354), $R_L = 1k\Omega$ to $V_{CC}/2$, $C_L = 5pF$, $T_A = +25^\circ C$, unless otherwise noted.)

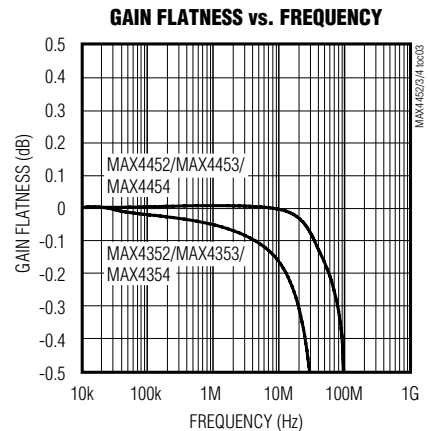
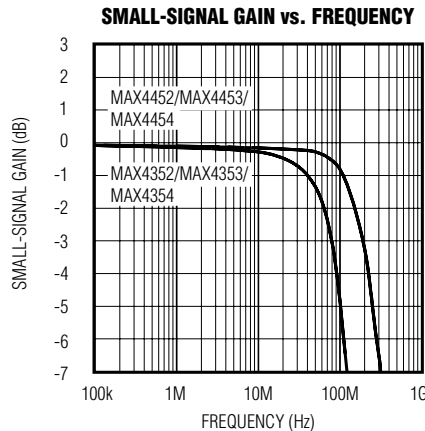
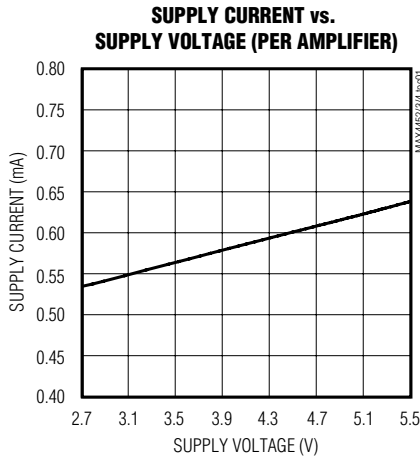

Low-Cost, +3V/+5V, 620µA, 200MHz, Single-Supply Op Amps with Rail-to-Rail Outputs

Typical Operating Characteristics (continued)

($V_{CC} = +5V$, $V_{EE} = 0$, $V_{CM} = +1.75V$, $A_{VCL} = +1V/V$ (MAX4452/MAX4453/MAX4454), $A_{VCL} = +5V/V$ (MAX4352/MAX4353/MAX4354), $R_L = 1k\Omega$ to $V_{CC}/2$, $C_L = 5pF$, $T_A = +25^\circ C$, unless otherwise noted.)

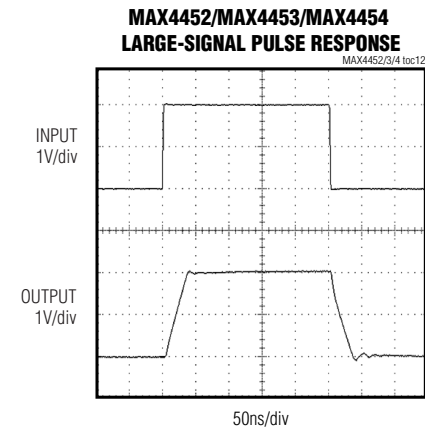
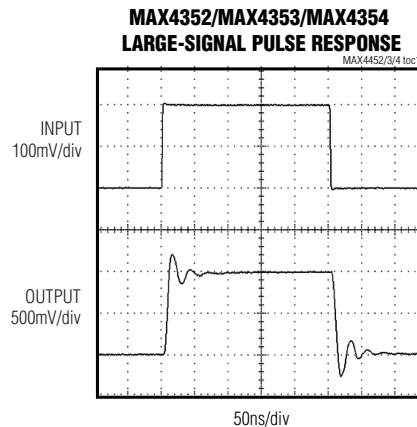
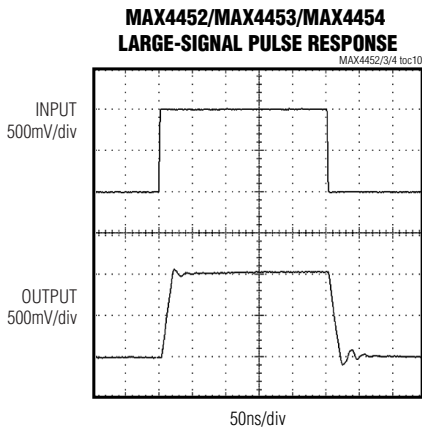
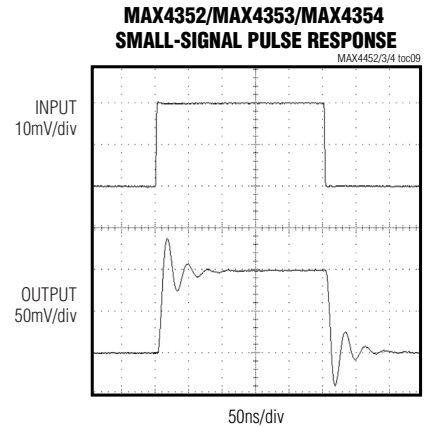
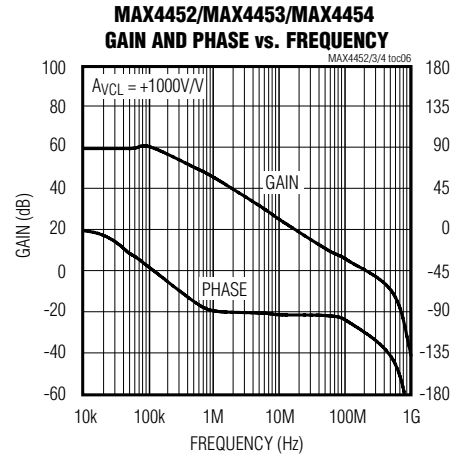
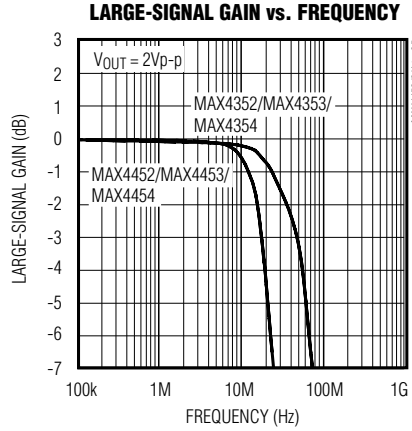

Low-Cost, +3V/+5V, 620 μ A, 200MHz, Single-Supply Op Amps with Rail-to-Rail Outputs

Typical Operating Characteristics (continued)

($V_{CC} = +5V$, $V_{EE} = 0$, $V_{CM} = +1.75V$, $A_{VCL} = +1V/V$ (MAX4452/MAX4453/MAX4454), $A_{VCL} = +5V/V$ (MAX4352/MAX4353/MAX4354), $R_L = 1k\Omega$ to $V_{CC}/2$, $C_L = 5pF$, $T_A = +25^\circ C$, unless otherwise noted.)

**MAX4352/MAX4353/MAX4354
LARGE-SIGNAL PULSE RESPONSE**



**MAX4452/MAX4453/MAX4454
SMALL-SIGNAL PULSE RESPONSE**

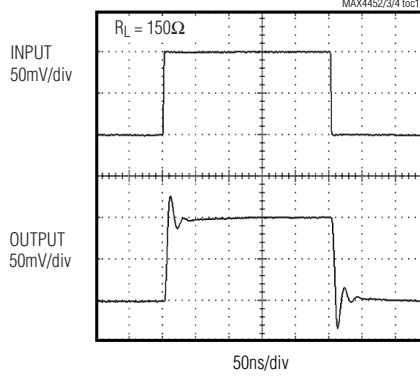

**MAX4352/MAX4353/MAX4354
SMALL-SIGNAL PULSE RESPONSE**



**MAX4452/MAX4453/MAX4454
LARGE-SIGNAL PULSE RESPONSE**



**MAX4352/MAX4353/MAX4354
LARGE-SIGNAL PULSE RESPONSE**

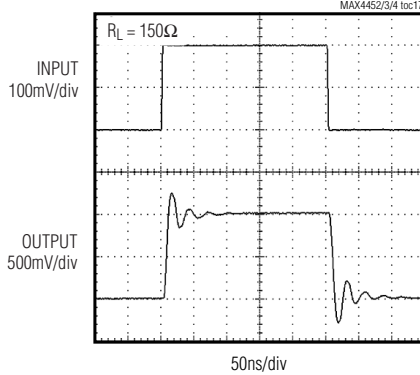

**CLOSED-LOOP OUTPUT
IMPEDANCE vs. FREQUENCY**

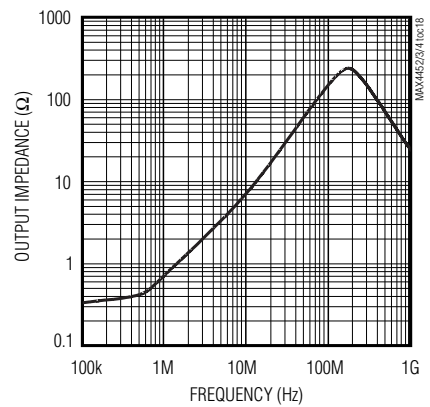

CROSSTALK vs. FREQUENCY



**OPEN-LOOP GAIN
vs. LOAD RESISTANCE**

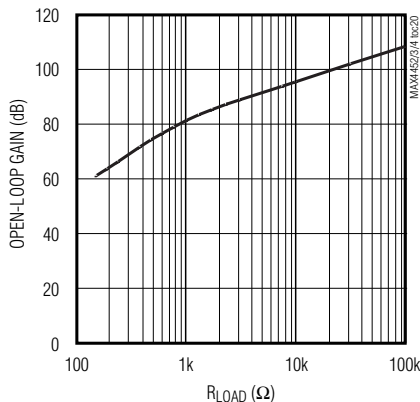

**POWER-SUPPLY REJECTION
vs. FREQUENCY**



Low-Cost, +3V/+5V, 620 μ A, 200MHz, Single-Supply Op Amps with Rail-to-Rail Outputs

Typical Operating Characteristics (continued)

($V_{CC} = +5V$, $V_{EE} = 0$, $V_{CM} = +1.75V$, $A_{VCL} = +1V/V$ (MAX4452/MAX4453/MAX4454), $A_{VCL} = +5V/V$ (MAX4352/MAX4353/MAX4354), $R_L = 1k\Omega$ to $V_{CC}/2$, $C_L = 5pF$, $T_A = +25^\circ C$, unless otherwise noted.)

COMMON-MODE REJECTION vs. FREQUENCY



VOLTAGE NOISE DENSITY vs. FREQUENCY



CURRENT NOISE DENSITY vs. FREQUENCY

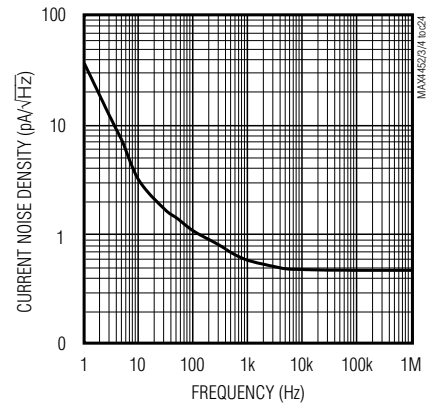

MAX4452/MAX4453/MAX4454 DISTORTION vs. FREQUENCY

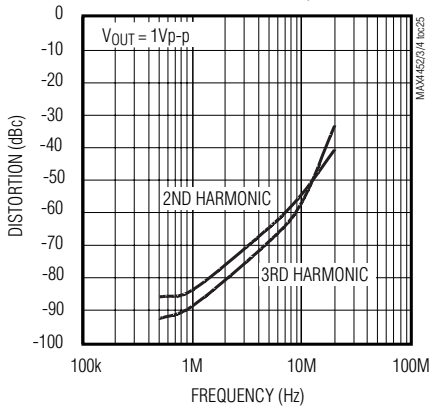

MAX4352/MAX4353/MAX4354 DISTORTION vs. FREQUENCY

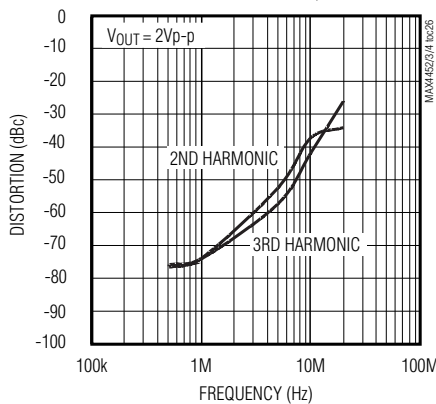

MAX4452/MAX4453/MAX4454 DISTORTION vs. OUTPUT VOLTAGE

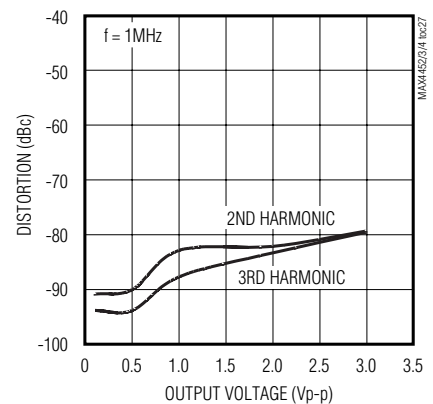

MAX4352/MAX4353/MAX4354 DISTORTION vs. OUTPUT VOLTAGE



MAX4452/MAX4453/MAX4454 DISTORTION vs. OUTPUT RESISTANCE

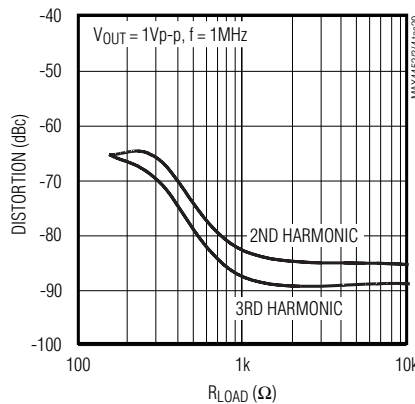

MAX4352/MAX4353/MAX4354 DISTORTION vs. OUTPUT RESISTANCE

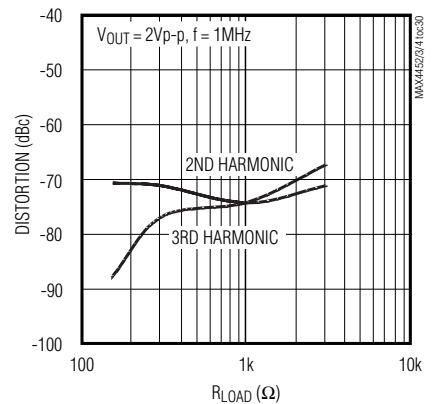

Low-Cost, +3V/+5V, 620 μ A, 200MHz, Single-Supply Op Amps with Rail-to-Rail Outputs

Typical Operating Characteristics (continued)

($V_{CC} = +5V$, $V_{EE} = 0$, $V_{CM} = +1.75V$, $A_{VCL} = +1V/V$ (MAX4452/MAX4453/MAX4454), $A_{VCL} = +5V/V$ (MAX4352/MAX4353/MAX4354), $R_L = 1k\Omega$ to $V_{CC}/2$, $C_L = 5pF$, $T_A = +25^\circ C$, unless otherwise noted.)

MAX4452/MAX4453/MAX4454/MAX4352/MAX4353/MAX4354

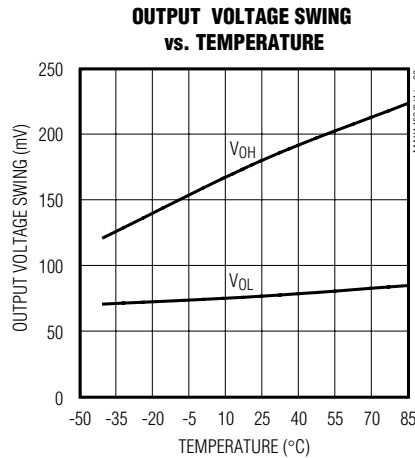
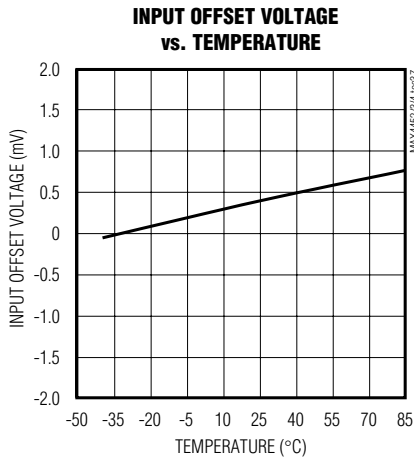
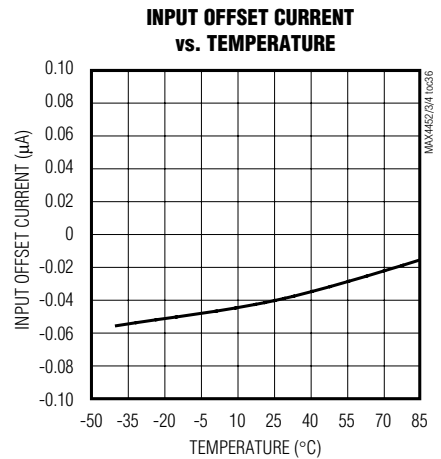
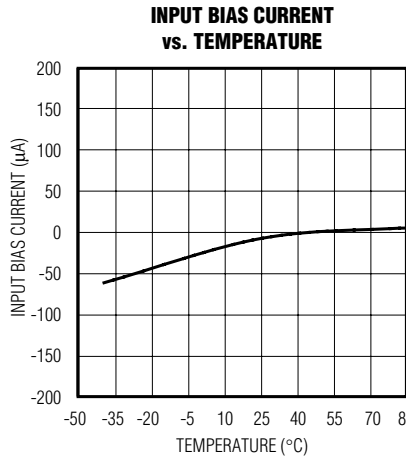
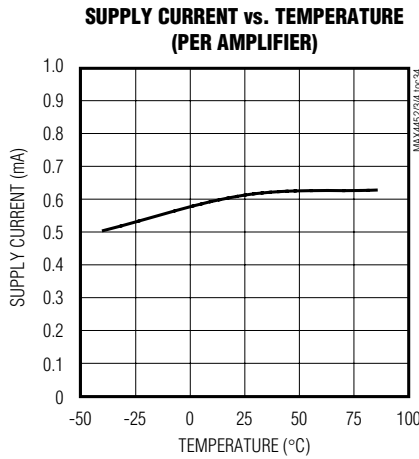
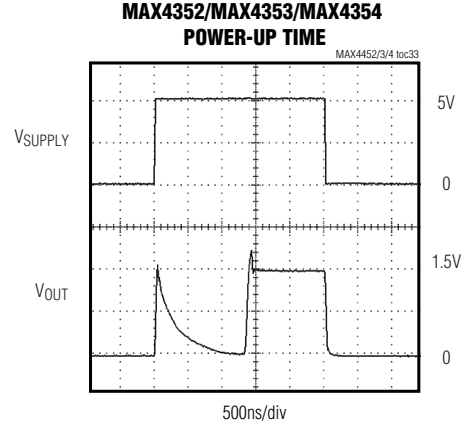
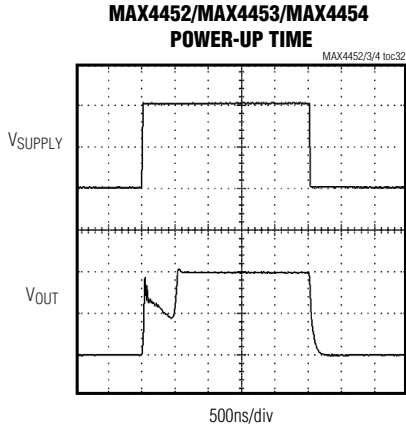
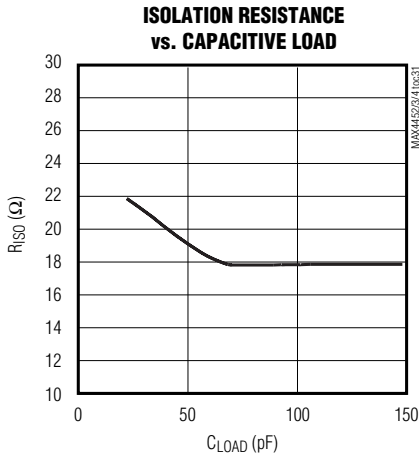

Low-Cost, +3V/+5V, 620 μ A, 200MHz, Single-Supply Op Amps with Rail-to-Rail Outputs

Pin Description

PIN			NAME	FUNCTION
MAX4452 MAX4352	MAX4453 MAX4353	MAX4454 MAX4354		
1	—	—	OUT	Amplifier Output
2	4	11	VEE	Negative Power Supply
3	—	—	IN+	Noninverting Amplifier Input
4	—	—	IN-	Inverting Amplifier Input
5	8	4	VCC	Positive Power Supply
—	1	1	OUTA	Amplifier A Output
—	2	2	INA-	Amplifier A Inverting Input
—	3	3	INA+	Amplifier A Noninverting Input
—	7	7	OUTB	Amplifier B Output
—	6	6	INB-	Amplifier B Inverting Input
—	5	5	INB+	Amplifier B Noninverting Input
—	—	8	OUTC	Amplifier C Output
—	—	9	INC-	Amplifier C Inverting Input
—	—	10	INC+	Amplifier C Noninverting Input
—	—	14	OUTD	Amplifier D Output
—	—	13	IND-	Amplifier D Inverting Input
—	—	12	IND+	Amplifier D Noninverting Input

Low-Cost, +3V/+5V, 620µA, 200MHz, Single-Supply Op Amps with Rail-to-Rail Outputs

Detailed Description

The MAX4452/MAX4352 single, MAX4453/MAX4353 dual, and MAX4454/MAX4354 quad, single-supply, rail-to-rail, voltage-feedback amplifiers achieve high slew rates and wide bandwidths while consuming only 620µA per amplifier. Excellent speed/power ratio makes them ideal for portable devices and high-frequency signal applications.

Internal feedback around the output stage ensures low open-loop output impedance, reducing gain sensitivity to load variations. This feedback also produces demand-driven current bias to the output transistors.

Rail-to-Rail Outputs, Ground-Sensing Input

The input common-mode range extends from ($V_{EE} - 0.1V$) to ($V_{CC} - 1.5V$) with excellent common-mode rejection. Beyond this range, the amplifier output is a nonlinear function of the input, but does not undergo phase reversal or latchup.

The output swings to within 180mV of either power-supply rail with a 1kΩ load. The input ground-sensing and the rail-to-rail output substantially increase the dynamic range.

Output Capacitive Loading and Stability

The MAX4452/MAX4453/MAX4454/MAX4352/MAX4353/MAX4354 are optimized for AC performance. They are not designed to drive highly reactive loads. Such loads decrease phase margin and may produce excessive ringing and oscillation. The use of an isolation resistor eliminates this problem (Figure 1). Figure 2 is a graph of the Optimal Isolation Resistor (R_{ISO}) vs. Capacitive Load.

Applications Information

Choosing Resistor Values

Unity-Gain Configuration

The MAX4452/MAX4453/MAX4454 are internally compensated for unity gain. When configured for unity gain, a 24Ω feedback resistor (R_F) is recommended. This resistor improves AC response by reducing the Q of the parallel LC circuit formed by the parasitic feedback capacitance and inductance.

Inverting and Noninverting Configurations

Select the gain-setting feedback (R_F) and input (R_G) resistor values that best fit the application. Large resistor values increase voltage noise and interact with the amplifier's input and PC board capacitance. This can generate undesirable poles and zeros and decrease bandwidth or cause oscillations. For example, a noninverting gain-of-two configuration ($R_F = R_G$) using 1kΩ

resistors, combined with 2pF of amplifier input capacitance and 1pF of PC board capacitance, causes a pole at 106MHz. Since this pole is within the amplifier bandwidth, it jeopardizes stability. Reducing the 1kΩ resistors to 100Ω extends the pole frequency to 1.06GHz, but could limit output swing by adding 200Ω in parallel with the amplifier's load resistor.

Note: For high-gain applications where output offset voltage is a consideration, choose R_S to be equal to the parallel combination of R_F and R_G (Figures 3a and 3b).

$$R_S = \frac{R_F \times R_G}{R_F + R_G}$$

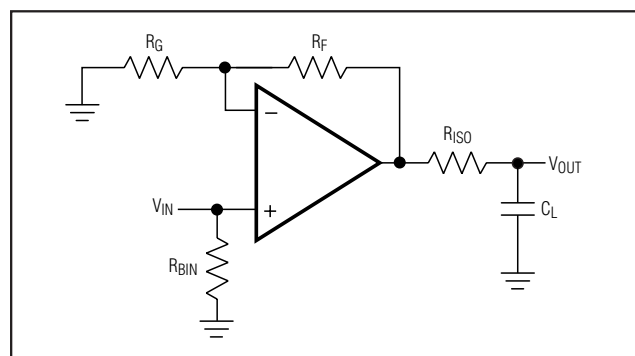

Figure 1. Driving a Capacitive Load Through an Isolation Resistor

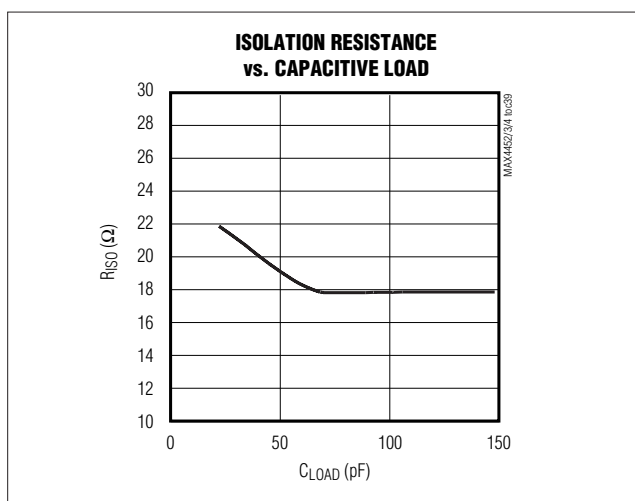

Figure 2. Optimal Isolation Resistor vs. Capacitive Load

Low-Cost, +3V/+5V, 620µA, 200MHz, Single-Supply Op Amps with Rail-to-Rail Outputs

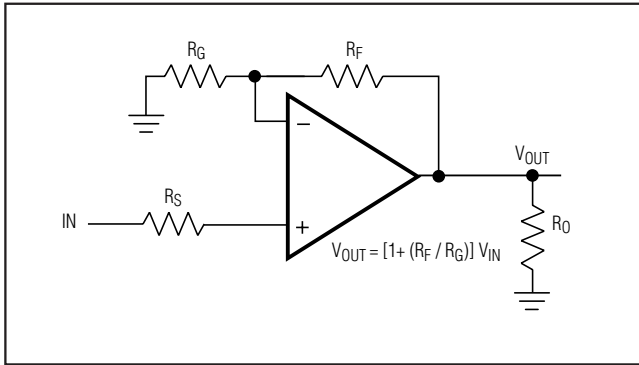

Figure 3a. Noninverting Gain Configuration

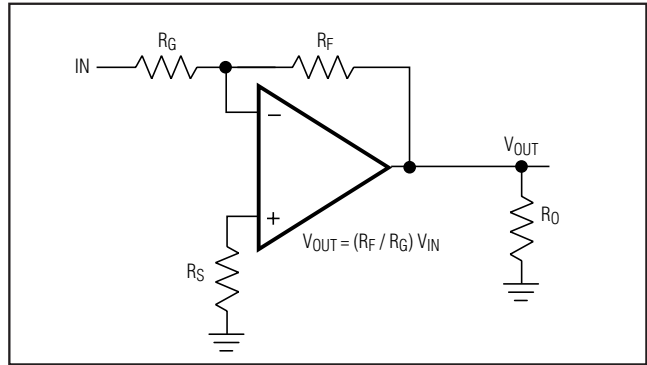

Figure 3b. Inverting Gain Configuration

Active Filters

The low distortion and high bandwidth of the MAX4452/MAX4453/MAX4454 and MAX4352/MAX4353/MAX4354 make them ideal for use in active filter circuits. Figure 4 is a 15MHz lowpass multiple feedback active filter using the MAX4452.

$$\text{Gain} = \frac{-R2}{R1}$$

$$f_0 = \frac{1}{2\pi} \sqrt{\frac{1}{R2 \times R3 \times C1 \times C2}}$$

$$Q = \frac{C2}{\sqrt{C1 \times C2 \times R2 \times R3} \left(\frac{1}{R1} + \frac{1}{R2} + \frac{1}{R3} \right)}$$

ADC Input Buffer

Input buffer amplifiers can be a source of significant errors in high-speed ADC applications. The input buffer is usually required to rapidly charge and discharge the ADC's input, which is often capacitive. See *Output Capacitive Loading and Stability*. In addition, since a high-speed ADC's input impedance often changes very rapidly during the conversion cycle, measurement accuracy must be maintained using an amplifier with very low output impedance at high frequencies. The combination of high speed, fast slew rate, low noise, and a low and stable distortion over load makes the MAX4452/MAX4453/MAX4454/MAX4352/MAX4353/MAX4354 ideally suited for use as buffer amplifiers in high-speed ADC applications.

Layout and Power-Supply Bypassing

These amplifiers operate from a single +2.7V to +5.25V power supply. Bypass VCC to ground with a 0.1µF capacitor as close to the pin as possible.

Maxim recommends using microstrip and stripline techniques to obtain full bandwidth. Design the PC board for a frequency greater than 1GHz to prevent amplifier performance degradation due to board parasitics. Avoid large parasitic capacitance at inputs and outputs. Whether or not a constant-impedance board is used, observe the following guidelines:

- Do not use wirewrap boards due to their high inductance.
- Do not use IC sockets because of the increased parasitic capacitance and inductance.

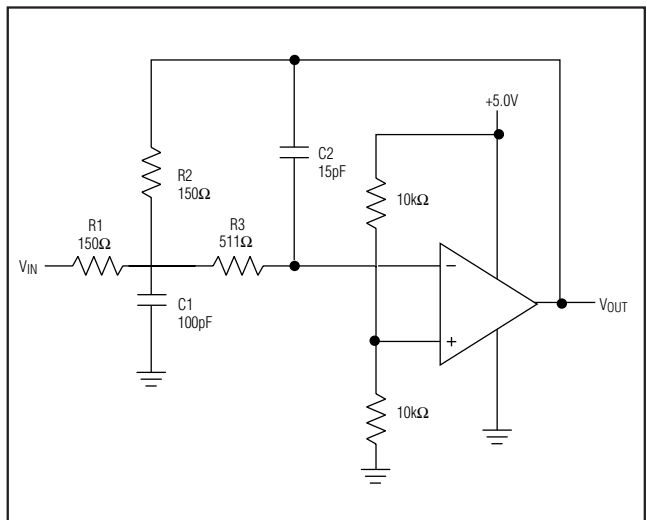

Figure 4. Multiple-Feedback Lowpass Filter

Low-Cost, +3V/+5V, 620µA, 200MHz, Single-Supply Op Amps with Rail-to-Rail Outputs

- Use surface-mount instead of through-hole components for better high-frequency performance.
- Use a PC board with at least two layers; it should be as free from voids as possible.
- Keep signal lines as short and as straight as possible. Do not make 90° turns; round all corners.

Chip Information

MAX4452/MAX4352 TRANSISTOR COUNT: 97
 MAX4453/MAX4353 TRANSISTOR COUNT: 192
 MAX4454/MAX4354 TRANSISTOR COUNT: 378
 PROCESS: Bipolar

Pin Configurations

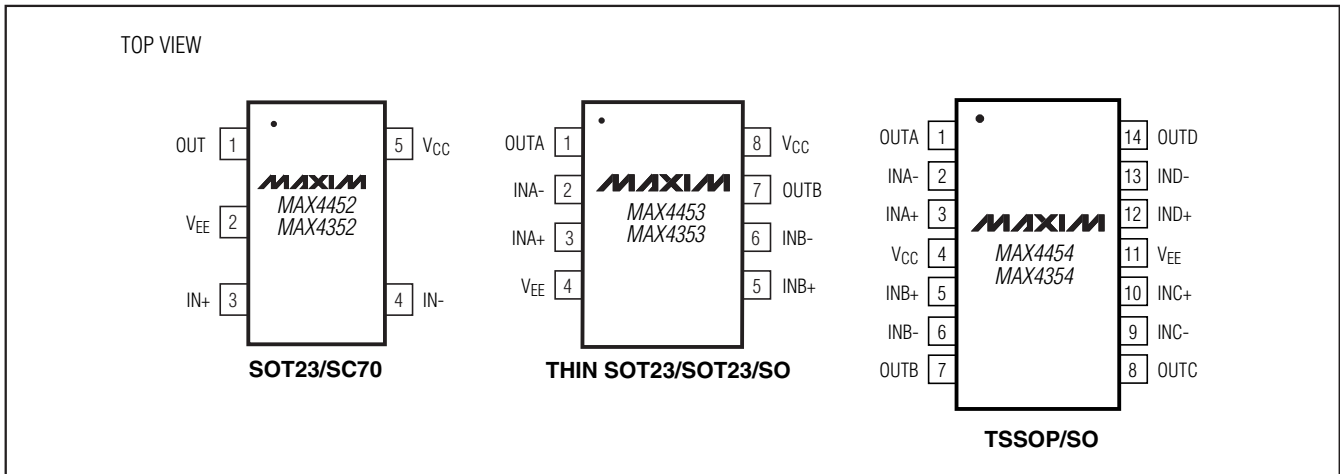

Low-Cost, +3V/+5V, 620µA, 200MHz, Single-Supply Op Amps with Rail-to-Rail Outputs

Package Information

(The package drawing(s) in this data sheet may not reflect the most current specifications. For the latest package outline information go to www.maxim-ic.com/packages.)



SC70, 5L, EPS

Low-Cost, +3V/+5V, 620µA, 200MHz, Single-Supply Op Amps with Rail-to-Rail Outputs

Package Information (continued)

(The package drawing(s) in this data sheet may not reflect the most current specifications. For the latest package outline information go to www.maxim-ic.com/packages.)

SOICN .EPS

DIM	INCHES		MILLIMETERS	
	MIN	MAX	MIN	MAX
A	0.053	0.069	1.35	1.75
A1	0.004	0.010	0.10	0.25
B	0.014	0.019	0.35	0.49
C	0.007	0.010	0.19	0.25
e	0.050 BSC		1.27 BSC	
E	0.150	0.157	3.80	4.00
H	0.228	0.244	5.80	6.20
L	0.016	0.050	0.40	1.27

VARIATIONS:

DIM	INCHES		MILLIMETERS		N	MS012
	MIN	MAX	MIN	MAX		
D	0.189	0.197	4.80	5.00	8	AA
D	0.337	0.344	8.55	8.75	14	AB
D	0.386	0.394	9.80	10.00	16	AC

NOTES:

- D&E DO NOT INCLUDE MOLD FLASH.
- MOLD FLASH OR PROTRUSIONS NOT TO EXCEED 0.15mm (.006").
- LEADS TO BE COPLANAR WITHIN 0.10mm (.004").
- CONTROLLING DIMENSION: MILLIMETERS.
- MEETS JEDEC MS012.
- N = NUMBER OF PINS.

DALLAS SEMICONDUCTOR **MAXIM**

PROPRIETARY INFORMATION

TITLE: PACKAGE OUTLINE, .150" SOIC

APPROVAL	DOCUMENT CONTROL NO. 21-0041	REV. B	1/1
----------	---------------------------------	-----------	-----

Low-Cost, +3V/+5V, 620µA, 200MHz, Single-Supply Op Amps with Rail-to-Rail Outputs

Package Information (continued)

(The package drawing(s) in this data sheet may not reflect the most current specifications. For the latest package outline information go to www.maxim-ic.com/packages.)

TOP VIEW

SIDE VIEW

FRONT VIEW

SYMBOL	MIN	MAX
A	0.90	1.45
A1	0.00	0.15
A2	0.90	1.30
b	0.35	0.50
C	0.08	0.20
D	2.80	3.00
E	2.60	3.00
E1	1.50	1.75
L	0.35	0.60
L1	0.60	REF
e	0.95	BSC.
e1	1.90	BSC.
α	0°	8°

NOTES:

- ALL DIMENSIONS ARE IN MILLIMETERS.
- FOOT LENGTH MEASURED AT INTERCEPT POINT BETWEEN DATUM A & LEAD SURFACE.
- PACKAGE OUTLINE EXCLUSIVE OF MOLD FLASH & METAL BURR. MOLD FLASH, PROTRUSION OR METAL BURR SHOULD NOT EXCEED 0.25 MM.
- PACKAGE OUTLINE INCLUSIVE OF SOLDER PLATING.
- MEETS JEDEC MO178, VARIATION AA.
- LEADS TO BE COPLANAR WITHIN 0.10 mm.
- SOLDER THICKNESS MEASURED AT FLAT SECTION OF LEAD BETWEEN 0.08mm AND 0.15mm FROM LEAD TIP.

DALLAS SEMICONDUCTOR **MAXIM**

PROPRIETARY INFORMATION

TITLE: PACKAGE OUTLINE, SOT-23, 5L

APPROVAL	DOCUMENT CONTROL NO. 21-0057	REV. E	1/1
----------	---------------------------------	-----------	-----

SOT-23 5L .EPS

Low-Cost, +3V/+5V, 620 μ A, 200MHz, Single-Supply Op Amps with Rail-to-Rail Outputs

Package Information (continued)

(The package drawing(s) in this data sheet may not reflect the most current specifications. For the latest package outline information go to www.maxim-ic.com/packages.)

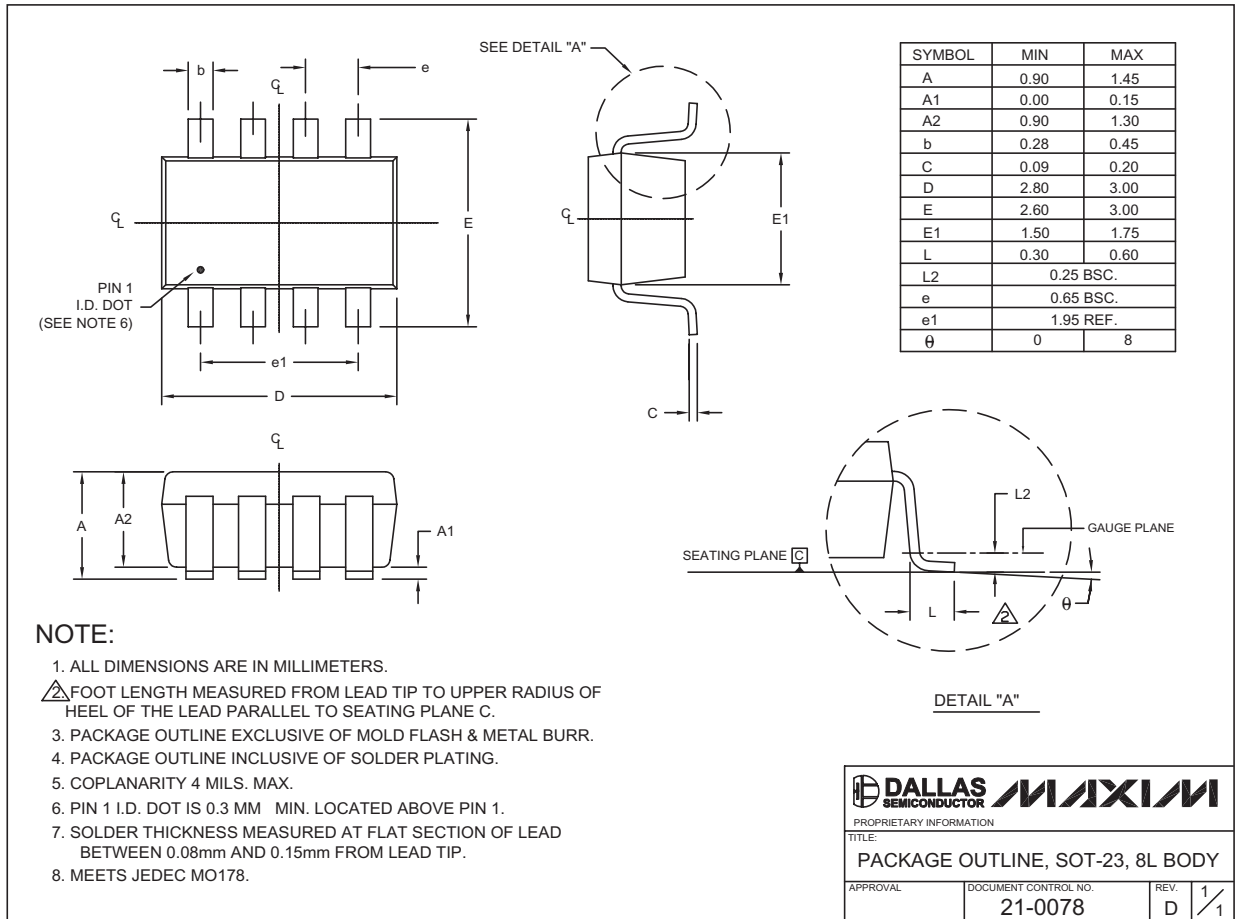

SOT23, 8L, EPS

MAX4452/MAX4453/MAX4454/MAX4352/MAX4353/MAX4354

Low-Cost, +3V/+5V, 620µA, 200MHz, Single-Supply Op Amps with Rail-to-Rail Outputs

Package Information (continued)

(The package drawing(s) in this data sheet may not reflect the most current specifications. For the latest package outline information go to www.maxim-ic.com/packages.)

SYMBOL	COMMON DIMENSIONS			
	MILLIMETERS		INCHES	
	MIN.	MAX.	MIN.	MAX.
A	—	1.10	—	.043
A ₁	0.05	0.15	.002	.006
A ₂	0.85	0.95	.033	.037
b	0.19	0.30	.007	.012
b ₁	0.19	0.25	.007	.010
c	0.09	0.20	.004	.008
c ₁	0.09	0.14	.004	.006
D	SEE VARIATIONS	SEE VARIATIONS	SEE VARIATIONS	SEE VARIATIONS
E	4.30	4.50	.169	.177
e	0.65 BSC		.026 BSC	
H	6.25	6.55	.246	.258
L	0.50	0.70	.020	.028
N	SEE VARIATIONS	SEE VARIATIONS	SEE VARIATIONS	SEE VARIATIONS
α	0°	8°	0°	8°

JEDEC	N	VARIATIONS				
		MILLIMETERS		INCHES		
		MIN.	MAX.	MIN.	MAX.	
AB-1	14	D	4.90	5.10	.193	.201
AB	16	D	4.90	5.10	.193	.201
AC	20	D	6.40	6.60	.252	.260
AD	24	D	7.70	7.90	.303	.311
AE	28	D	9.60	9.80	.378	.386

NOTES:
 1. DIMENSIONS D AND E DO NOT INCLUDE FLASH
 2. MOLD FLASH OR PROTRUSIONS NOT TO EXCEED 0.15mm PER SIDE
 3. CONTROLLING DIMENSION: MILLIMETER
 4. MEETS JEDEC OUTLINE MO-153. SEE JEDEC VARIATIONS TABLE
 5. 'N' REFERS TO NUMBER OF LEADS
 6. THE LEAD TIPS MUST LIE WITHIN A SPECIFIED ZONE. THIS TOLERANCE ZONE IS DEFINED BY TWO PARALLEL PLANES. ONE PLANE IS THE SEATING PLANE, DATUM [-C-]; THE OTHER PLANE IS AT THE SPECIFIED DISTANCE FROM [-C-] IN THE DIRECTION INDICATED

DALLAS SEMICONDUCTOR **MAXIM**
 PROPRIETARY INFORMATION
 TITLE: PACKAGE OUTLINE, TSSOP 4.40mm BODY
 APPROVAL: [] DOCUMENT CONTROL NO. 21-0066 REV. F 1/1

TSSOP4.40mm EPS

Low-Cost, +3V/+5V, 620µA, 200MHz, Single-Supply Op Amps with Rail-to-Rail Outputs

Package Information (continued)

(The package drawing(s) in this data sheet may not reflect the most current specifications. For the latest package outline information go to www.maxim-ic.com/packages.)



NOTES :

1. ALL DIMENSIONS ARE IN MILLIMETER.
2. 'D' & 'E1' ARE REFERENCE DATUM AND DO NOT INCLUDE MOLD FLASH OR PROTRUSIONS, AND ARE MEASURED AT THE BOTTOM PARTING LINE, MOLD FLASH OR PROTRUSION SHALL NOT EXCEED 0.15 MM ON 'D' AND 0.15 MM ON 'E1' PER SIDE.
3. THE LEAD WIDTH DIMENSION DOES NOT INCLUDE DAMBAR PROTRUSION. ALLOWABLE DAMBAR PROTRUSION SHALL BE 0.07MM TOTAL IN EXCESS OF THE LEAD WIDTH DIMENSION AT MAXIMUM MATERIAL CONDITION.
4. DATUM PLANE 'H' LOCATED AT MOLD PARTING LINE AND COINCIDENT WITH LEAD, WHERE LEAD EXITS PLASTIC BODY AT THE BOTTOM OF PARTING LINE.
5. TERMINAL POSITIONS ARE SHOWN FOR REFERENCE ONLY.
6. DIMENSION IS THE LENGTH OF TERMINAL FOR SOLDERING TO A SUBSTRATE.
7. LEADS TO BE COPLANAR AT 0.1mm MAXIMUM.
8. THIS PART IS COMPLIANT WITH JEDEC SPECIFICATION M0-193, VARIATION 'BA'.

SYMBOLS	ALL DIMENSIONS ARE IN MILLIMETERS		
	MIN	NOM	MAX
A	-	-	1.10
A1	0.025	0.075	0.10
A2	0.85	0.88	0.90
A3	0.50 BSC		
b	0.22	-	0.38
b1	0.22	0.30	0.33
c	0.15	-	0.20
c1	0.12	0.127	0.15
D	2.80	2.90	3.00
E	2.75 BSC		
E1	1.55	1.60	1.65
L	0.30	0.40	0.50
e1	1.95 BSC		
e	0.65 BSC		
N	8		
CC	0°	4°	8°

DALLAS SEMICONDUCTOR		
MAXIM		
PROPRIETARY INFORMATION		
TITLE: PACKAGE OUTLINE, 8L THIN SOT (LOW PROFILE)		
APPROVAL	DOCUMENT CONTROL NO. 21-0154	REV. A 2/2

Maxim cannot assume responsibility for use of any circuitry other than circuitry entirely embodied in a Maxim product. No circuit patent licenses are implied. Maxim reserves the right to change the circuitry and specifications without notice at any time.

19 **Maxim Integrated Products, 120 San Gabriel Drive, Sunnyvale, CA 94086 408-737-7600**

Компания «Океан Электроники» предлагает заключение долгосрочных отношений при поставках импортных электронных компонентов на взаимовыгодных условиях!

Наши преимущества:

- Поставка оригинальных импортных электронных компонентов напрямую с производств Америки, Европы и Азии, а так же с крупнейших складов мира;
- Широкая линейка поставок активных и пассивных импортных электронных компонентов (более 30 млн. наименований);
- Поставка сложных, дефицитных, либо снятых с производства позиций;
- Оперативные сроки поставки под заказ (от 5 рабочих дней);
- Экспресс доставка в любую точку России;
- Помощь Конструкторского Отдела и консультации квалифицированных инженеров;
- Техническая поддержка проекта, помощь в подборе аналогов, поставка прототипов;
- Поставка электронных компонентов под контролем ВП;
- Система менеджмента качества сертифицирована по Международному стандарту ISO 9001;
- При необходимости вся продукция военного и аэрокосмического назначения проходит испытания и сертификацию в лаборатории (по согласованию с заказчиком);
- Поставка специализированных компонентов военного и аэрокосмического уровня качества (Xilinx, Altera, Analog Devices, Intersil, Interpoint, Microsemi, Actel, Aeroflex, Peregrine, VPT, Syfer, Eurofarad, Texas Instruments, MS Kennedy, Miteq, Cobham, E2V, MA-COM, Hittite, Mini-Circuits, General Dynamics и др.);

Компания «Океан Электроники» является официальным дистрибьютором и эксклюзивным представителем в России одного из крупнейших производителей разъемов военного и аэрокосмического назначения «JONHON», а так же официальным дистрибьютором и эксклюзивным представителем в России производителя высокотехнологичных и надежных решений для передачи СВЧ сигналов «FORSTAR».



JONHON

«JONHON» (основан в 1970 г.)

Разъемы специального, военного и аэрокосмического назначения:

(Применяются в военной, авиационной, аэрокосмической, морской, железнодорожной, горно- и нефтедобывающей отраслях промышленности)

«FORSTAR» (основан в 1998 г.)

ВЧ соединители, коаксиальные кабели, кабельные сборки и микроволновые компоненты:

(Применяются в телекоммуникациях гражданского и специального назначения, в средствах связи, РЛС, а так же военной, авиационной и аэрокосмической отраслях промышленности).



Телефон: 8 (812) 309-75-97 (многоканальный)

Факс: 8 (812) 320-03-32

Электронная почта: ocean@oceanchips.ru

Web: <http://oceanchips.ru/>

Адрес: 198099, г. Санкт-Петербург, ул. Калинина, д. 2, корп. 4, лит. А