

## MAX20002/MAX20003

## 36V, 220kHz to 2.2MHz, 2A/3A Fully Integrated Step-Down Converters with 15µA Operating Current

### General Description

The MAX20002/MAX20003 are small, synchronous buck converters with integrated high-side and low-side MOSFETs. Each device is designed to deliver up to 2A/3A with input voltages from 3.5V to 36V, while using only 15µA quiescent current at no load. Voltage quality can be monitored by observing the PGOOD signal. The devices can operate in dropout by running at 98% duty cycle, making them ideal for automotive applications.

The devices offer fixed output voltages of 5V/3.3V, along with the ability to program the output voltage between 1V to 10V. Frequency can be programmed using a resistor to ground on the FOSC pin from 220kHz to 2.2MHz. The devices offer a forced fixed-frequency mode and skip mode with ultra-low quiescent current of 15µA. They have a pin that can be programmed to turn on/off the spread spectrum, further helping systems designers with better EMC management.

The MAX20002/MAX20003 are available in a small 5mm x 5mm 20-pin TQFN package with exposed pad and use very few external components.

### Applications

- Point-of-Load Applications in Automotive
- Distributed DC Power Systems
- Navigation and Radio Head Units

### Benefits and Features

- Synchronous DC-DC Converter with Integrated FETs
  - MAX20002 = 2A
  - MAX20003 = 3A
  - 15µA Quiescent Current When in Standby Mode
- Small Solution Size Saves Space
  - 220kHz to 2.2MHz Adjustable Frequency
  - Programmable 1V to 10V Output for the Buck or Fixed 5V/3.3V Options Available
  - Fixed 8ms Internal Soft-Start
  - Fixed Output Voltage with ±2% Output Accuracy (5V/3.3V) or Externally Resistor Adjustable (1V to 10V) with ±1% FB Accuracy
- PGOOD Output and High-Voltage EN Input Simplify Power Sequencing
- Protection Features and Operating Range Ideal for Automotive Applications
  - Operating  $V_{IN}$  Range of 3.5V to 36V
  - 42V Load-Dump Protection
  - 99% Duty-Cycle Operation with Low Dropout
  - -40°C to +125°C Automotive Temperature Range
  - AEC-Q100 Qualified

Ordering Information appears at end of data sheet.

Typical Application Circuit/Block Diagram

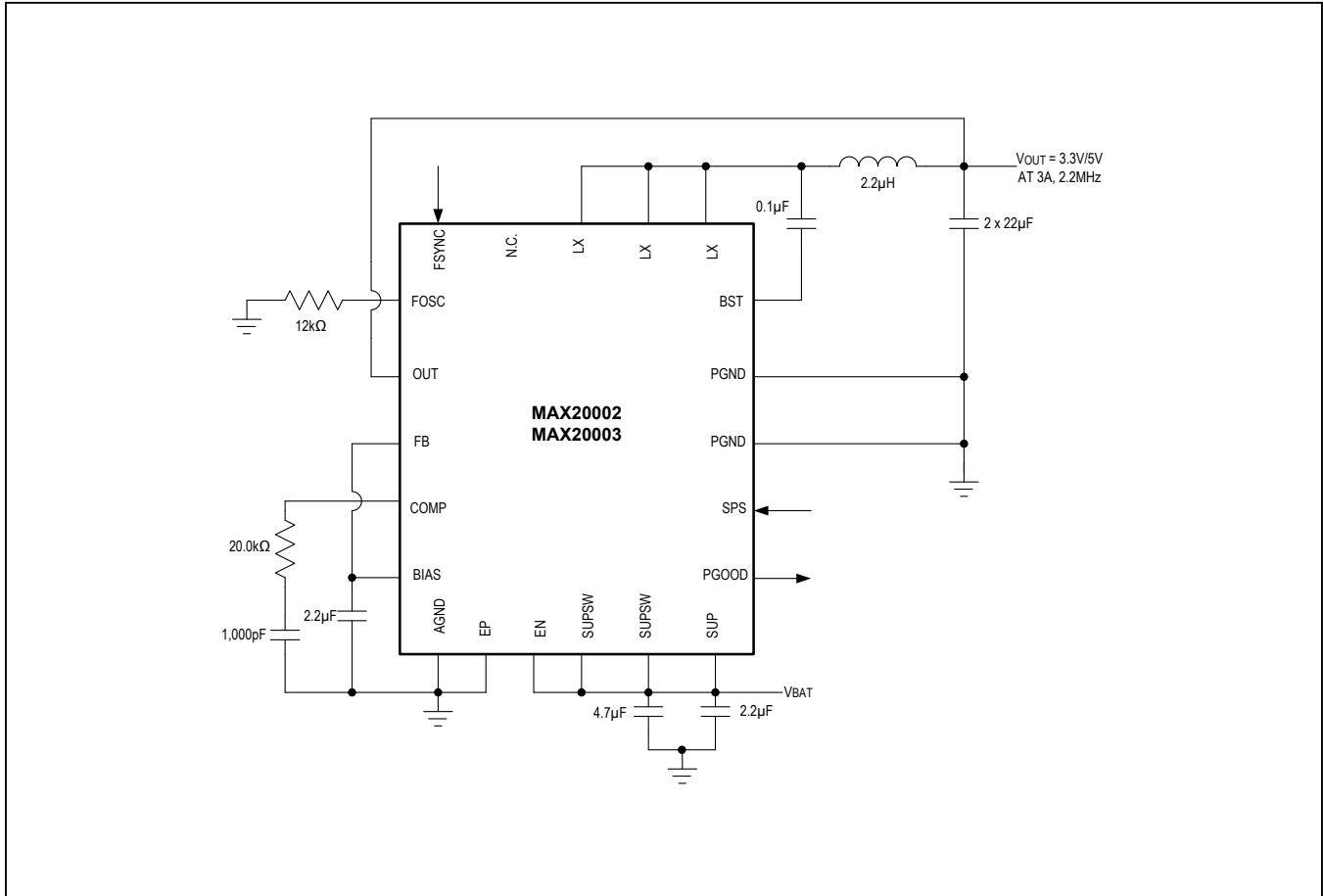

**Absolute Maximum Ratings**

SUP, SUPSW, LX, EN to PGND .....	-0.3V to +42V	Output Short-Circuit Duration .....	Continuous
SUP to SUPSW .....	-0.3V to +0.3V	Continuous Power Dissipation (T <sub>A</sub> = +70°C)	
BIAS to AGND .....	-0.3V to +6V	20-Pin TQFN (derate 33.3mW/°C above +70°C) ..	2666.7mW
SPS, FOSC, COMP to AGND .....	-0.3V to (V <sub>BIAS</sub> + 0.3V)	Operating Temperature Range .....	-40°C to +125°C
FSYNC, PGOOD, FB to AGND .....	-0.3V to (V <sub>BIAS</sub> + 0.3V)	Junction Temperature .....	+150°C
OUT to PGND .....	-0.3V to +12V	Storage Temperature Range .....	-65°C to +150°C
BST to LX .....	-0.3V to +6V	Lead Temperature (soldering, 10s) .....	+300°C
AGND to PGND .....	-0.3V to +0.3V	Soldering Temperature (reflow) .....	+260°C

*Stresses beyond those listed under "Absolute Maximum Ratings" may cause permanent damage to the device. These are stress ratings only, and functional operation of the device at these or any other conditions beyond those indicated in the operational sections of the specifications is not implied. Exposure to absolute maximum rating conditions for extended periods may affect device reliability.*

**Package Thermal Characteristics (Note 1)**

TQFN

Junction-to-Ambient Thermal Resistance (θ <sub>JA</sub> ) .....	30°C/W
Junction-to-Case Thermal Resistance (θ <sub>JC</sub> ) .....	2°C/W

**Note 1:** Package thermal resistances were obtained using the method described in JEDEC specification JESD51-7, using a four-layer board. For detailed information on package thermal considerations, refer to [www.maximintegrated.com/thermal-tutorial](http://www.maximintegrated.com/thermal-tutorial).

**Electrical Characteristics**

V<sub>SUP</sub> = V<sub>SUPSW</sub> = 14V, V<sub>EN</sub> = 14V, L1 = 2.2µH, C<sub>IN</sub> = 4.7µF, C<sub>OUT</sub> = 44µF, C<sub>BIAS</sub> = 2.2µF, C<sub>BST</sub> = 0.1µF, R<sub>FOSC</sub> = 12kΩ, T<sub>A</sub> = T<sub>J</sub> = -40°C to +125°C, unless otherwise noted. Typical values are at T<sub>A</sub> = +25°C.

PARAMETER	SYMBOL	CONDITIONS	MIN	TYP	MAX	UNITS
Supply Voltage	V <sub>SUP</sub> , V <sub>SUPSW</sub>		3.5		36	V
Load-Dump Event Supply Voltage	V <sub>SUP_LD</sub>	t <sub>LD</sub> < 1s			42	V
Supply Current	I <sub>SUP_STANDBY</sub>	Standby mode, no load, V <sub>OUT</sub> = 3.3V, V <sub>FSYNC</sub> = 0V		15	30	µA
Supply Current (5V)	I <sub>SUP_STANDBY</sub>	Standby mode, no load, V <sub>OUT</sub> = 5V, V <sub>FSYNC</sub> = 0V		20	35	µA
Shutdown Supply Current	I <sub>SHDN</sub>	V <sub>EN</sub> = 0V		5	10	µA
BIAS Regulator Voltage	V <sub>BIAS</sub>	V <sub>SUP</sub> = V <sub>SUPSW</sub> = 6V to 42V. I <sub>BIAS</sub> = 0 to 10mA	4.7	5	5.4	V
BIAS Undervoltage Lockout	V <sub>UVBIAS</sub>	V <sub>BIAS</sub> rising	2.9	3.15	3.4	V
BIAS Undervoltage-Lockout Hysteresis				400	500	mV
Thermal-Shutdown Threshold				175		°C
Thermal-Shutdown Threshold Hysteresis				15		°C

**Electrical Characteristics (continued)**

$V_{SUP} = V_{SUPSW} = 14V$ ,  $V_{EN} = 14V$ ,  $L1 = 2.2\mu H$ ,  $C_{IN} = 4.7\mu F$ ,  $C_{OUT} = 44\mu F$ ,  $C_{BIAS} = 2.2\mu F$ ,  $C_{BST} = 0.1\mu F$ ,  $R_{FOSC} = 12k\Omega$ ,  $T_A = T_J = -40^\circ C$  to  $+125^\circ C$ , unless otherwise noted. Typical values are at  $T_A = +25^\circ C$ .

PARAMETER	SYMBOL	CONDITIONS	MIN	TYP	MAX	UNITS
<b>OUTPUT VOLTAGE</b>						
PWM-Mode Output Voltage (Note 2)	$V_{OUT\_5V}$	$V_{FB} = V_{BIAS}$ , $6V < V_{SUPSW} < 36V$ , fixed-frequency mode	4.9	5	5.1	V
	$V_{OUT\_4.2V}$		4.12	4.2	4.28	
	$V_{OUT\_3.3V}$		3.23	3.3	3.37	
Skip-Mode Output Voltage (Note 3)	$V_{OUT\_SKIP\_5V}$	No load, $V_{FB} = V_{BIAS}$ , skip mode	4.9	5	5.15	V
	$V_{OUT\_SKIP\_4.2V}$		4.12	4.2	4.33	
	$V_{OUT\_SKIP\_3.3V}$		3.23	3.3	3.4	
Load Regulation		$V_{FB} = V_{BIAS}$ , $30mA < I_{LOAD} < 3A$		0.5		%
Line Regulation		$V_{FB} = V_{BIAS}$ , $6V < V_{SUPSW} < 36V$		0.02		%/V
BST Input Current	$I_{BST\_ON}$	High-side MOSFET on, $V_{BST} - V_{LX} = 5V$		1.5		mA
	$I_{BST\_OFF}$	High-side MOSFET off, $V_{BST} - V_{LX} = 5V$		1.5		µA
LX Current Limit	$I_{LX}$	MAX20003	3.75	5	6.25	A
		MAX20002	2.5	3.33	4.16	
LX Rise Time		$V_{OUT} = 5V, 3.3V$		4		ns
Spread Spectrum		Spread spectrum enabled		FOSC ±3%		
High-Side Switch On-Resistance	$R_{ON\_H}$	$I_{LX} = 0.5A$ , $V_{BIAS} = 5V$		60	140	mΩ
High-Side Switch Leakage Current		High-side MOSFET off, $V_{SUP} = 36V$ , $V_{LX} = 0V$ , $T_A = +25^\circ C$		1	5	µA
Low-Side Switch On-Resistance	$R_{ON\_L}$	$I_{LX} = 0.5A$ , $V_{BIAS} = 5V$		35	70	mΩ
Low-Side Switch Leakage Current		Low-side MOSFET off, $V_{SUP} = 36V$ , $V_{LX} = 36V$ , $T_A = +25^\circ C$		1	5	µA
FB Input Current	$I_{FB}$	$T_A = +25^\circ C$		20	100	nA
FB Regulation Voltage	$V_{FB}$	FB connected to an external resistive divider, $6V < V_{SUPSW} < 36V$	0.99	1	1.01	V
FB Line Regulation	$\Delta V_{LINE}$	$6V < V_{SUPSW} < 36V$		0.02		%/V
Transconductance (from FB to COMP)	gm	$V_{FB} = 1V$ , $V_{BIAS} = 5V$		700		µS
Minimum On-Time	$t_{ON\_MIN}$				80	ns
Maximum Duty Cycle	$DC_{MAX}$			98	99	%

**Electrical Characteristics (continued)**

$V_{SUP} = V_{SUPSW} = 14V$ ,  $V_{EN} = 14V$ ,  $L1 = 2.2\mu H$ ,  $C_{IN} = 4.7\mu F$ ,  $C_{OUT} = 44\mu F$ ,  $C_{BIAS} = 2.2\mu F$ ,  $C_{BST} = 0.1\mu F$ ,  $R_{FOSC} = 12k\Omega$ ,  $T_A = T_J = -40^\circ C$  to  $+125^\circ C$ , unless otherwise noted. Typical values are at  $T_A = +25^\circ C$ .

PARAMETER	SYMBOL	CONDITIONS	MIN	TYP	MAX	UNITS
Oscillator Frequency		$R_{FOSC} = 73.2k\Omega$		400		kHz
		$R_{FOSC} = 12k\Omega$	2.0	2.2	2.4	MHz
<b>SYNC, EN, AND SPS LOGIC THRESHOLDS</b>						
External Input Clock Acquisition Time	$t_{FSYNC}$			1		Cycle
External Input Clock Frequency		$R_{FOSC} = 12k\Omega$ (Note 4)	1.8		2.6	MHz
External Input Clock High Threshold	$V_{FSYNC\_HI}$	$V_{FSYNC}$ rising	1.4			V
External Input Clock Low Threshold	$V_{FSYNC\_LO}$	$V_{FSYNC}$ falling			0.4	V
FSYNC Leakage Current		$T_A = +25^\circ C$			1	$\mu A$
Soft-Start Time	$t_{SS}$		5.6	8	12	ms
Enable Input High Threshold	$V_{EN\_HI}$		2.4			V
Enable Input Low Threshold	$V_{EN\_LO}$				0.6	V
Enable Threshold-Voltage Hysteresis	$V_{EN\_HYS}$			0.2		V
Enable Input Current	$I_{EN}$	$T_A = +25^\circ C$		0.1	1	$\mu A$
Spread-Spectrum Input High Threshold	$V_{SPS\_HI}$		2.0			V
Spread-Spectrum Input Low Threshold	$V_{SPS\_LO}$				0.4	V
Spread-Spectrum Input Current	$I_{SPS}$	$T_A = +25^\circ C$		0.1	1	$\mu A$
<b>POWER-GOOD AND OVERVOLTAGE-PROTECTION THRESHOLDS</b>						
PGOOD Switching Level	$V_{RISING}$	$V_{FB}$ rising, $V_{PGOOD} = \text{high}$	93	95	97	% $V_{FB}$
	$V_{FALLING}$	$V_{FB}$ falling, $V_{PGOOD} = \text{low}$	90	92.5	95	
PGOOD Debounce Time				25		$\mu s$
PGOOD Output Low Voltage		$I_{SINK} = 5mA$			0.4	V
PGOOD Leakage Current		$V_{OUT}$ in regulation, $T_A = +25^\circ C$			1	$\mu A$
Overvoltage Protection Threshold		$V_{OUT}$ rising (Monitor FB pin)		107		%
		$V_{OUT}$ falling (Monitor FB pin)		104		
		$V_{OUT}$ rising (Monitor FB pin) (MAX20002C/MAX20003C only)		105		
		$V_{OUT}$ falling (Monitor FB pin) (MAX20002C/MAX20003C only)		103		

**Note 2:** Device not in dropout condition.

**Note 3:** Guaranteed by design; not production tested.

**Note 4:** Contact the factory for SYNC frequency outside the specified range.

Typical Operating Characteristics

( $V_{SUP} = V_{SUPSW} = 14V$ ,  $V_{EN} = 14V$ ,  $V_{OUT} = 5V$ ,  $V_{FSYNC} = 0V$ ,  $R_{FOSC} = 12k\Omega$ ,  $T_A = +25^\circ C$ , unless otherwise noted.)

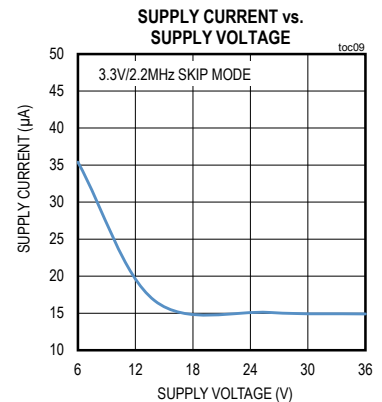
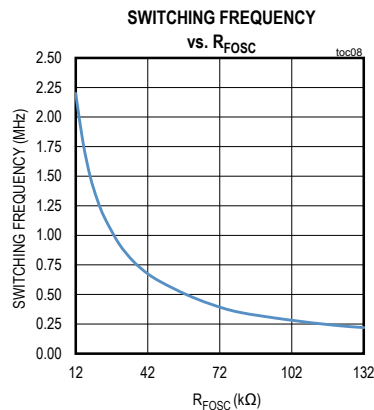
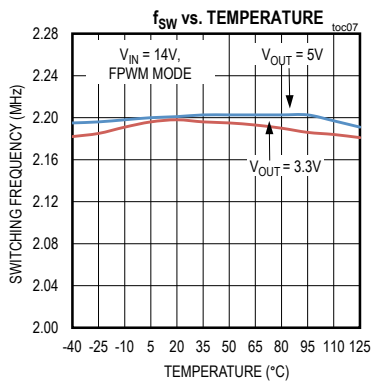
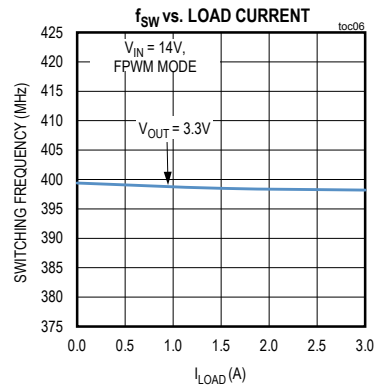
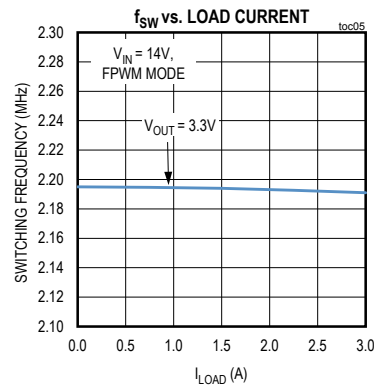
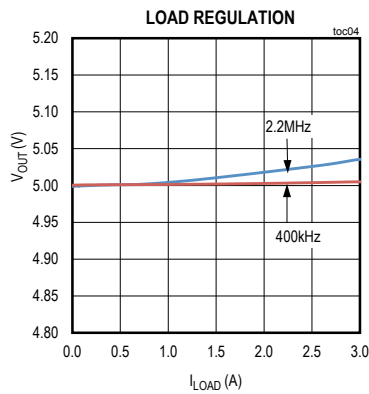
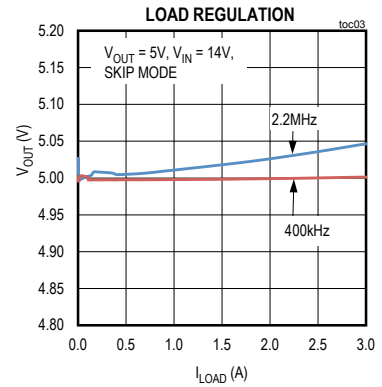
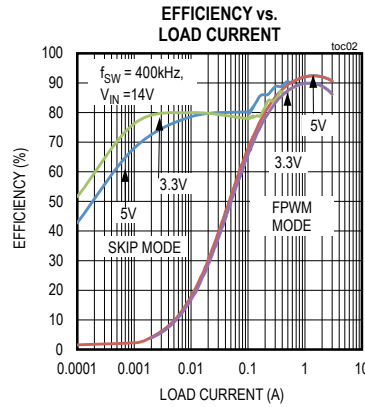
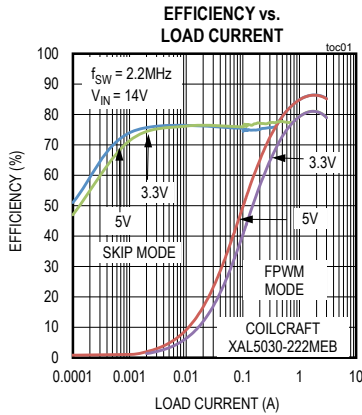

Typical Operating Characteristics (continued)

( $V_{SUP} = V_{SUPSW} = 14V$ ,  $V_{EN} = 14V$ ,  $V_{OUT} = 5V$ ,  $V_{FSYNC} = 0V$ ,  $R_{FOSC} = 12k\Omega$ ,  $T_A = +25^\circ C$ , unless otherwise noted.)

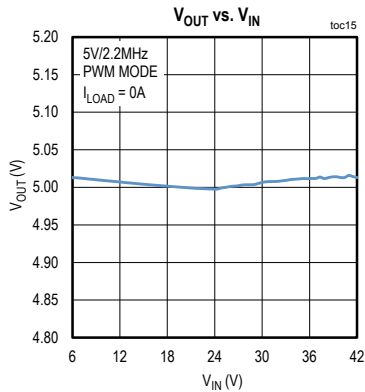
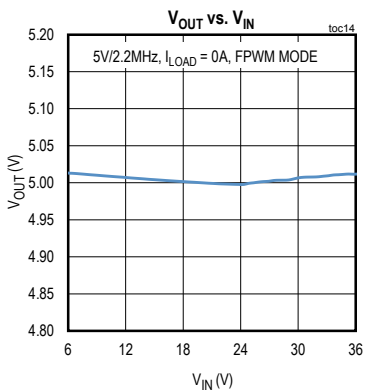
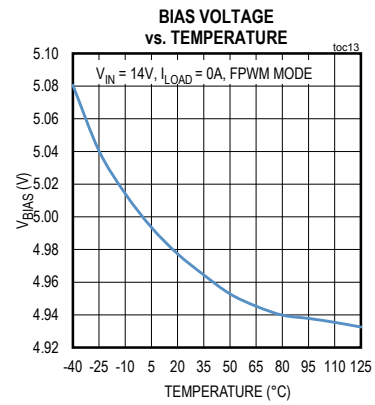
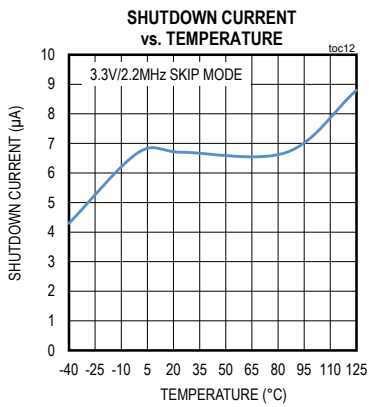
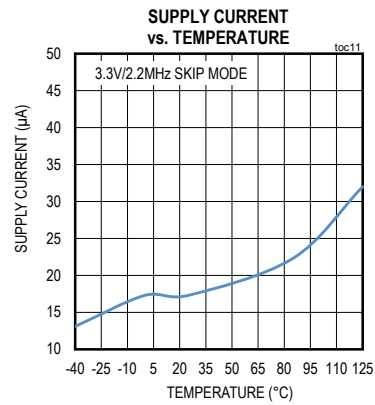
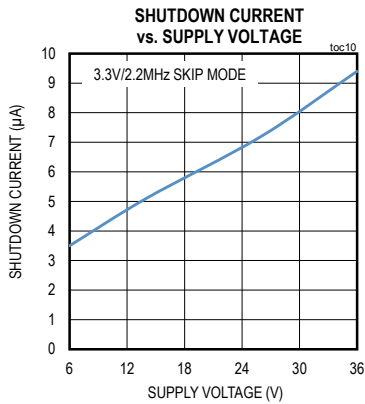

Typical Operating Characteristics (continued)

( $V_{SUP} = V_{SUPSW} = 14V$ ,  $V_{EN} = 14V$ ,  $V_{OUT} = 5V$ ,  $V_{FSYNC} = 0V$ ,  $R_{FOSC} = 12k\Omega$ ,  $T_A = +25^\circ C$ , unless otherwise noted.)

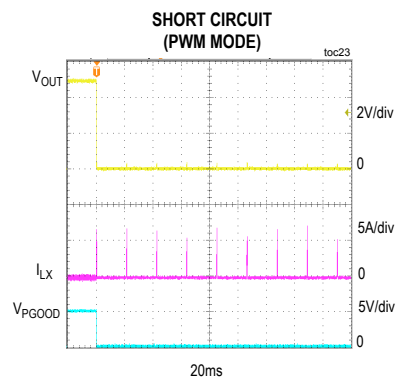
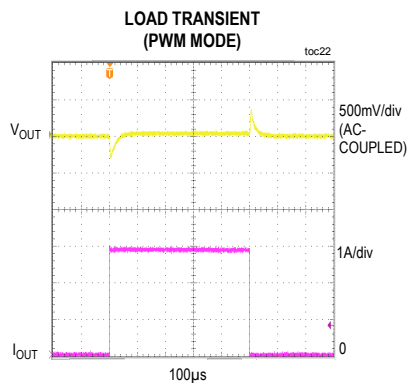
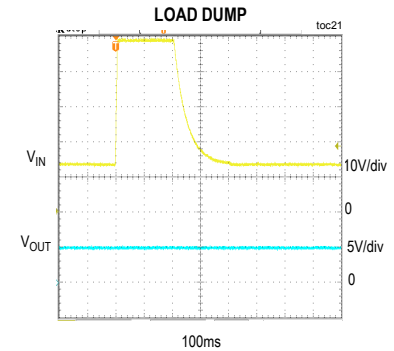
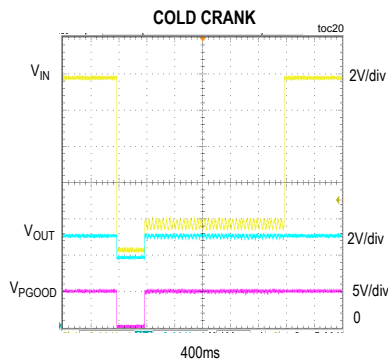
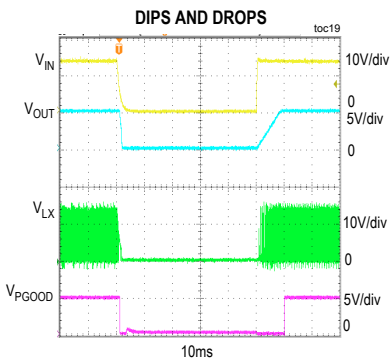
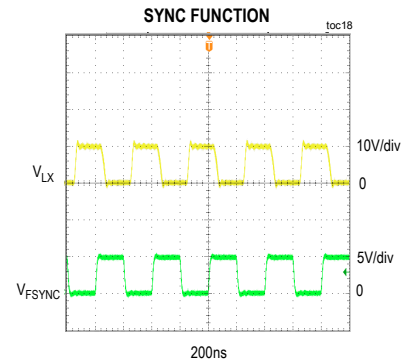
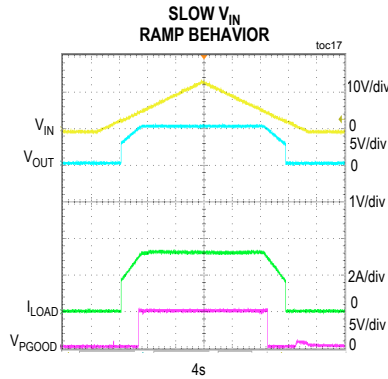
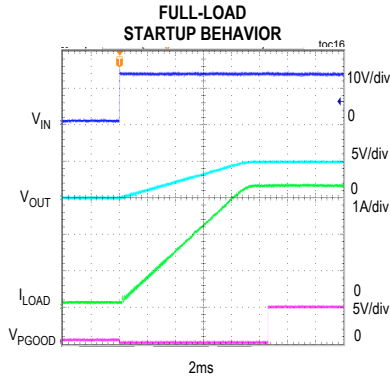



Pin Configuration

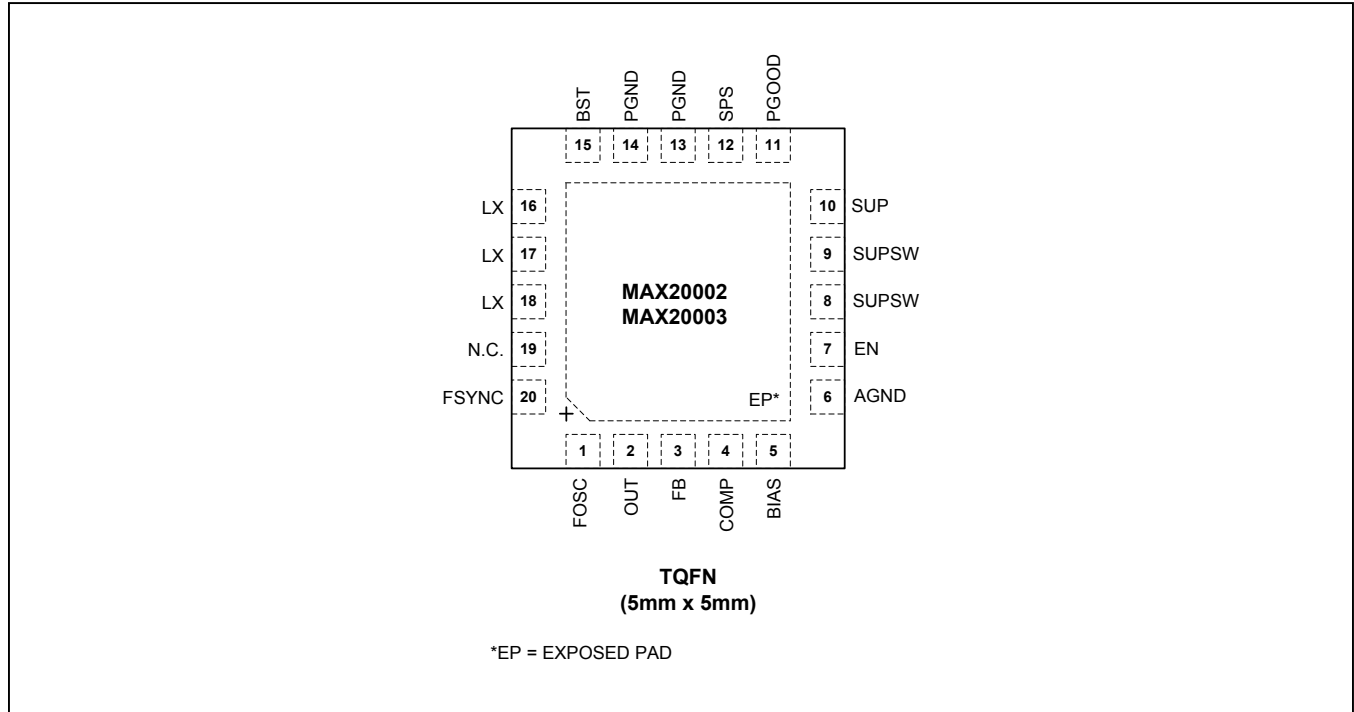

Pin Description

PIN	NAME	FUNCTION
1	FOSC	Resistor-Programmable Switching Frequency Setting Control Input. Connect a resistor from FOSC to AGND to set the switching frequency.
2	OUT	Switching Regulator Output. OUT also provides power to the internal circuitry when the output voltage of the converter is set between 3V to 5V during standby mode.
3	FB	Feedback Input. Connect an external resistive divider from OUT to FB and AGND to set the output voltage. Connect to BIAS to set the output voltage to 5V or 3.3V.
4	COMP	Error Amplifier Output. Connect an RC network from COMP to AGND for stable operation. See the <i>Compensation Network</i> section for more details.
5	BIAS	Linear Regulator Output. BIAS powers up the internal circuitry. Bypass with a minimum of 2.2µF ceramic capacitor to ground.
6	AGND	Analog Ground
7	EN	SUP Voltage-Compatible Enable Input. Drive EN low to disable the devices. Drive EN high to enable the devices.
8, 9	SUPSW	Internal High-Side Switch Supply Input. SUPSW provides power to the internal switch. Bypass SUPSW to PGND with a 0.1µF and 4.7µF ceramic capacitors.
10	SUP	Voltage Supply Input. SUP powers up the internal linear regulator. Bypass SUP to PGND with a 2.2µF ceramic capacitor.
11	PGOOD	Open-Drain, PGOOD Output. PGOOD asserts when $V_{OUT}$ is above 95% regulation point. PGOOD goes low when $V_{OUT}$ is below 92% regulation point.

**Pin Description (continued)**

<b>PIN</b>	<b>NAME</b>	<b>FUNCTION</b>
12	SPS	Spread-Spectrum Pin. Pull high for spread spectrum on and low for spread spectrum off.
13,14	PGND	Power Ground
15	BST	High-Side Driver Supply. Connect a 0.1 $\mu$ F capacitor between LX and BST for proper operation.
16–18	LX	Inductor Switching Node
19	N.C.	No Connection
20	FSYNC	Synchronization Input. The devices synchronize to an external signal applied to FSYNC. Connect FSYNC to AGND to enable skip mode operation. Connect to BIAS or to an external clock to enable fixed-frequency, forced-PWM mode operation.
—	EP	Exposed Pad. Connect EP to a large-area contiguous copper ground plane for effective power dissipation. Do not use as the only IC ground connection. EP must be connected to PGND.

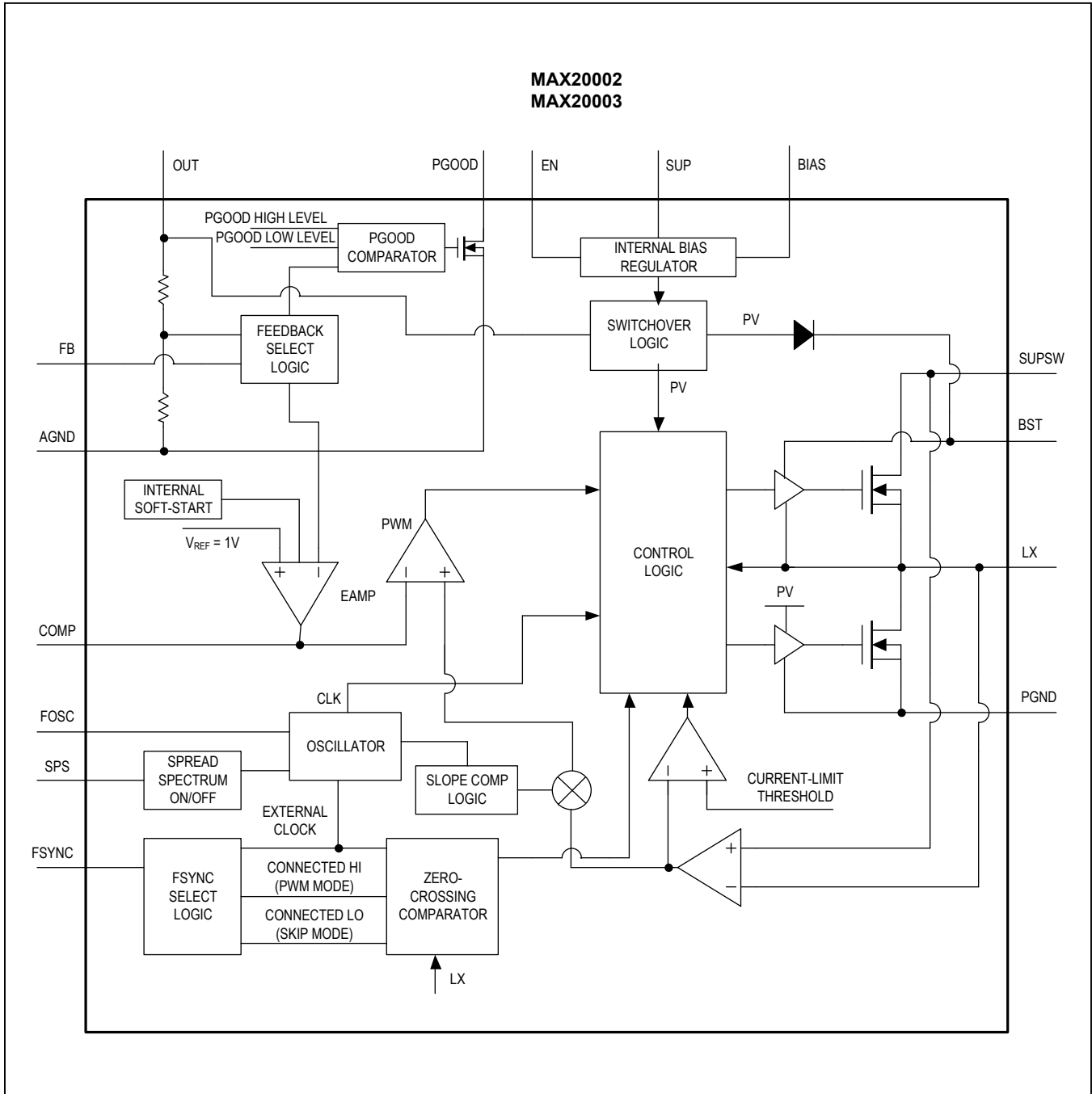

Figure 1. Internal Block Diagram

## Detailed Description

The MAX20002/MAX20003 are 2A/3A current-mode step-down converters with integrated high-side and low-side MOSFETs. The low-side MOSFET enables fixed-frequency, forced-PWM operation in light-load applications. The devices operate with input voltages from 3.5V to 36V while using only 15µA quiescent current at no load. The switching frequency is resistor programmable from 220kHz to 2.2MHz and can be synchronized to an external clock. The devices' output voltage is available as 5V/3.3V fixed or adjustable from 1V to 10V. The wide input voltage range, along with its ability to operate at 99% duty cycle during undervoltage transients, makes the devices ideal for automotive applications.

In light-load applications, a logic input (FSYNC) allows the devices to operate either in skip mode for reduced current consumption, or fixed-frequency, forced-PWM mode to eliminate frequency variation and help minimize EMI. Protection features include cycle-by-cycle current limit, and thermal shutdown with automatic recovery.

### Wide Input Voltage Range

The devices include two separate supply inputs (SUP and SUPSW) specified for a wide 3.5V to 36V input voltage range.  $V_{SUP}$  provides power to the device and  $V_{SUPSW}$  provides power to the internal switch. When the device is operating with a 3.5V input supply, conditions such as cold crank can cause the voltage at the SUP and SUPSW pins to drop below the programmed output voltage. Under such conditions, the devices operate in a high duty-cycle mode to facilitate minimum dropout from input to output.

### Maximum Duty-Cycle Operation

The devices have a maximum duty cycle of 98% (typ). The IC monitors the off time (time for which the low-side FET is on) in both PWM and skip modes every switching cycle. Once the off time of 100ns (typ) is detected continuously for 12µs, the low-side FET is forced on for 150ns (typ) every 12µs. The input voltage at which the devices enter dropout changes depending on the input voltage, output voltage, switching frequency, load current, and the efficiency of the design.

The input voltage at which the devices enter dropout can be approximated as:

$$V_{SUP} = \frac{V_{OUT} + (I_{OUT} \times R_{ON\_H})}{0.98}$$

**Note:** The equation above does not take into account the efficiency and switching frequency but is a good

first-order approximation. Use the  $R_{ON\_H}$  number from the max column in the [Electrical Characteristics](#) table.

### Linear Regulator Output (BIAS)

The devices include a 5V linear regulator ( $V_{BIAS}$ ) that provides power to the internal circuit blocks. Connect a 2.2µF ceramic capacitor from BIAS to AGND.

### Power-Good Output (PGOOD)

The devices feature an open-drain power-good output (PGOOD). PGOOD asserts when  $V_{OUT}$  rises above 95% of its regulation voltage. PGOOD deasserts when  $V_{OUT}$  drops below 92.5% of its regulation voltage. Connect PGOOD to BIAS with a 10kΩ resistor.

### Synchronization Input (FSYNC)

FSYNC is a logic-level input useful for operating-mode selection and frequency control. Connecting FSYNC to BIAS or to an external clock enables fixed-frequency, forced-PWM operation. Connecting FSYNC to AGND enables skip-mode operation.

The external clock frequency at FSYNC can be higher or lower than the internal clock by 20%. If the external clock frequency is greater than 120% of the internal clock, contact the factory applications team to verify the design. The devices synchronize to the external clock in two cycles. When the external clock signal at FSYNC is absent for more than two clock cycles, the devices use the internal clock.

### System Enable (EN)

An enable control input (EN) activates the devices from their low-power shutdown mode. EN is compatible with inputs from automotive battery level down to 3.5V. The high-voltage compatibility allows EN to be connected to SUP, KEY/KL30, or the inhibit pin (INH) of a CAN transceiver.

EN turns on the internal regulator. Once  $V_{BIAS}$  is above the internal lockout threshold,  $V_{UVBIAS} = 3.15V$  (typ), the converter activates and the output voltage ramps up within 8ms.

A logic-low at EN shuts down the device. During shutdown, the internal linear regulator and gate drivers turn off. Shutdown is the lowest power state and reduces the quiescent current to 5µA (typ). Drive EN high to bring the devices out of shutdown.

### Spread-Spectrum Option

The spread spectrum can be enabled on the device using a pin. When the SPS pin is pulled high the spread spectrum is enabled and the operating frequency is varied  $\pm 3\%$  centered on FOSC. The modulation signal is a triangular wave with a period of 110µs at 2.2MHz. Therefore, FOSC ramps down 3% and back to 2.2MHz in 110µs and also ramps up 3% and back to 2.2MHz in 110µs. The cycle repeats.

For operations at FOSC values other than 2.2MHz, the modulation signal scales proportionally (e.g., at 400kHz, the 110µs modulation period increases to 110µs  $\times$  2.2MHz/0.4MHz = 550µs).

The internal spread spectrum is disabled if the devices are synchronized to an external clock. However, the devices do not filter the input clock on the FSYNC pin and pass any modulation (including spread spectrum) present on the driving external clock.

### Internal Oscillator (FOSC)

The switching frequency ( $f_{SW}$ ) is set by a resistor ( $R_{FOSC}$ ) connected from FOSC to AGND. For example, a 400kHz switching frequency is set with  $R_{FOSC} = 73.2k\Omega$ . Higher frequencies allow designs with lower inductor values and less output capacitance. Consequently, peak currents and  $I^2R$  losses are lower at higher switching frequencies, but core losses, gate-charge currents, and switching losses increase.

### Overtemperature Protection

Thermal overload protection limits the total power dissipation in the device. When the junction temperature exceeds 175°C (typ), an internal thermal sensor shuts down the internal bias regulator and the step-down converter, allowing the IC to cool. The thermal sensor turns on the IC again after the junction temperature cools by 15°C.

## Applications Information

### Setting the Output Voltage

Connect FB to BIAS for a fixed +5V/3.3V output voltage. To set the output to other voltages between 1V and 10V, connect a resistive divider from output (OUT) to FB to AGND (Figure 2). Select  $R_{FB2}$  (FB to AGND resistor) less than or equal to 500kΩ. Calculate  $R_{FB1}$  (OUT to FB resistor) with the following equation:

$$R_{FB1} = R_{FB2} \left[ \left( \frac{V_{OUT}}{V_{FB}} \right) - 1 \right]$$

where  $V_{FB} = 1V$  (see the [Electrical Characteristics](#) table).

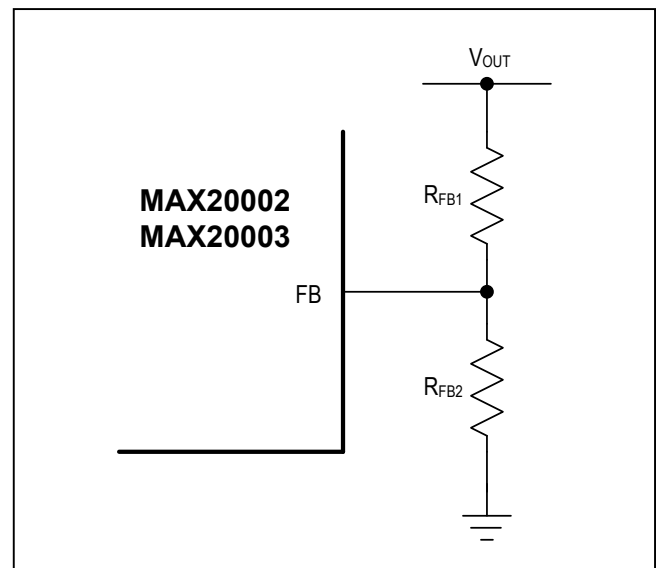

Figure 2. Adjustable Output-Voltage Setting

### Forced-PWM and Skip Modes

In PWM mode of operation, the devices switch at a constant frequency with variable on-time. In skip mode of operation, the converter's switching frequency is load dependent. At higher load current, the switching frequency does not change and the operating mode is similar to the PWM mode. Skip mode helps improve efficiency in light-load applications by allowing the converters to turn on the high-side switch only when the output voltage falls below a set threshold. As such, the converters do not switch MOSFETs on and off as often as in the PWM mode. Consequently, the gate charge and switching losses are much lower in skip mode.

### Inductor Selection

Three key inductor parameters must be specified for operation with the devices: inductance value (L), inductor saturation current ( $I_{SAT}$ ), and DC resistance ( $R_{DCR}$ ). To select inductor value, the ratio of inductor peak-to-peak AC current to DC average current (LIR) must be selected first. A good compromise between size and loss is a 30% peak-to-peak ripple current to average-current ratio (LIR = 0.3). The switching frequency, input voltage, output voltage, and selected LIR then determine the inductor value as follows:

$$L = \frac{(V_{SUP} - V_{OUT}) \times V_{OUT}}{V_{SUP} \times f_{SW} \times I_{OUT} \times LIR}$$

where  $V_{SUP}$ ,  $V_{OUT}$ , and  $I_{OUT}$  are typical values (so that efficiency is optimum for typical conditions). The switching frequency is set by  $R_{FOSC}$  (see TOC 8 in the *Typical Operating Characteristics* section).

### Input Capacitor

The input filter capacitor reduces peak currents drawn from the power source and reduces noise and voltage ripple on the input caused by the circuit's switching.

The input capacitor RMS current requirement ( $I_{RMS}$ ) is defined by the following equation:

$$I_{RMS} = I_{LOAD(MAX)} \times \frac{\sqrt{V_{OUT} \times (V_{SUP} - V_{OUT})}}{V_{SUP}}$$

$I_{RMS}$  has a maximum value when the input voltage equals twice the output voltage:

$$V_{SUP} = 2 \times V_{OUT}$$

therefore:

$$I_{RMS} = \frac{I_{LOAD(MAX)}}{V_{SUP}}$$

Choose an input capacitor that exhibits less than +10°C self-heating temperature rise at the RMS input current for optimal long-term reliability.

The input-voltage ripple is comprised of  $\Delta V_Q$  (caused by the capacitor discharge) and  $\Delta V_{ESR}$  (caused by the ESR of the capacitor). Use low-ESR ceramic capacitors with high ripple-current capability at the input. Assume the contribution from the ESR and capacitor discharge equal to 50%. Calculate the input capacitance and ESR required for a specified input voltage ripple using the following equations:

$$ESR_{IN} = \frac{\Delta V_{ESR}}{I_{OUT} + \frac{\Delta I_L}{2}}$$

where:

$$\Delta I_L = \frac{(V_{SUP} - V_{OUT}) \times V_{OUT}}{V_{SUP} \times f_{SW} \times L}$$

and:

$$C_{IN} = \frac{I_{OUT} \times D(1-D)}{\Delta V_Q \times f_{SW}}$$

$$D = \frac{V_{OUT}}{V_{SUPSW}}$$

where:  $I_{OUT}$  is the maximum output current and D is the duty cycle.

### Output Capacitor

The output filter capacitor must have low enough equivalent-series resistance (ESR) to meet output-ripple and load-transient requirements. The output capacitance must be high enough to absorb the inductor energy while transitioning from full-load to no-load conditions without tripping the overvoltage-fault protection. When using high-capacitance, low-ESR capacitors, the filter capacitor's ESR dominates the output-voltage ripple, so the size of the output capacitor depends on the maximum ESR required to meet the output-voltage ripple ( $V_{RIPPLE(P-P)}$ ) specifications:

$$V_{RIPPLE(P-P)} = ESR \times I_{LOAD(MAX)} \times LIR$$

The actual capacitance value required relates to the physical size needed to achieve low ESR, as well as to the chemistry of the capacitor technology. Thus, the capacitor is usually selected by ESR and voltage rating rather than by capacitance value.

36V, 220kHz to 2.2MHz, 2A/3A Fully Integrated Step-Down Converters with 15µA Operating Current

When using low-capacity filter capacitors, such as ceramic capacitors, size is usually determined by the capacity needed to prevent voltage droop and voltage rise from causing problems during load transients. Generally, once enough capacitance is added to meet the overshoot requirement, undershoot at the rising load edge is no longer a problem. However, low-capacity filter capacitors typically have high-ESR zeros that can affect the overall stability.

**Compensation Network**

The devices use an internal transconductance error amplifier with its inverting input and its output available to the user for external frequency compensation. The output capacitor and compensation network determine the loop stability. The inductor and the output capacitor are chosen based on performance, size, and cost. Additionally, the compensation network optimizes the control-loop stability.

The converter uses a current-mode control scheme that regulates the output voltage by forcing the required current through the external inductor. The devices use the voltage drop across the high-side MOSFET to sense inductor current. Current-mode control eliminates the double pole in the feedback loop caused by the inductor and output capacitor, resulting in a smaller phase shift and requiring less elaborate error-amplifier compensation than voltage-mode control. Only a simple single series resistor ( $R_C$ ) and capacitor ( $C_C$ ) are required to have a stable, high-bandwidth loop in applications where ceramic capacitors are used for output filtering (see Figure 3). For other types of capacitors, due to the higher capacitance and ESR, the frequency of the zero created by the capacitance and ESR is lower than the desired closed-loop crossover frequency. To stabilize a nonceramic output-capacitor loop, add another compensation capacitor ( $C_F$ ) from COMP to ground to cancel this ESR zero.

The basic regulator loop is modeled as a power modulator, output feedback divider, and an error amplifier. The power modulator has a DC gain set by  $g_m \times R_{LOAD}$ , with a pole and zero pair set by  $R_{LOAD}$ , the output capacitor ( $C_{OUT}$ ), and its ESR. The following equations help to approximate the value for the gain of the power modulator ( $GAIN_{MOD(dc)}$ ), neglecting the effect of the ramp stabilization. Ramp stabilization is necessary when the duty cycle is above 50% and is internally done for the devices:

$$GAIN_{MOD(dc)} = g_{mc} \times R_{LOAD}$$

where  $R_{LOAD} = V_{OUT}/I_{OUT(MAX)}$  in  $\Omega$  and  $g_{mc} = 3S$ .

In a current-mode step-down converter, the output capacitor, its ESR, and the load resistance introduce a pole at the following frequency:

$$f_{pMOD} = \frac{1}{2\pi \times C_{OUT} \times R_{LOAD}}$$

The output capacitor and its ESR also introduce a zero at:

$$f_{zMOD} = \frac{1}{2\pi \times ESR \times C_{OUT}}$$

When  $C_{OUT}$  is composed of “n” identical capacitors in parallel, the resulting  $C_{OUT} = n \times C_{OUT(EACH)}$ , and  $ESR = ESR(EACH)/n$ . Note that the capacitor zero for a parallel combination of alike capacitors is the same as for an individual capacitor.

The feedback voltage-divider has a gain of  $GAIN_{FB} = V_{FB}/V_{OUT}$ , where  $V_{FB}$  is 1V (typ).

The transconductance error amplifier has a DC gain of  $GAIN_{EA(DC)} = g_{m\_EA} \times R_{OUT\_EA}$ , where  $g_{m\_EA}$  is the error amplifier transconductance, which is 700µS (typ), and  $R_{OUT\_EA}$  is the output resistance of the error amplifier (50M $\Omega$ ).

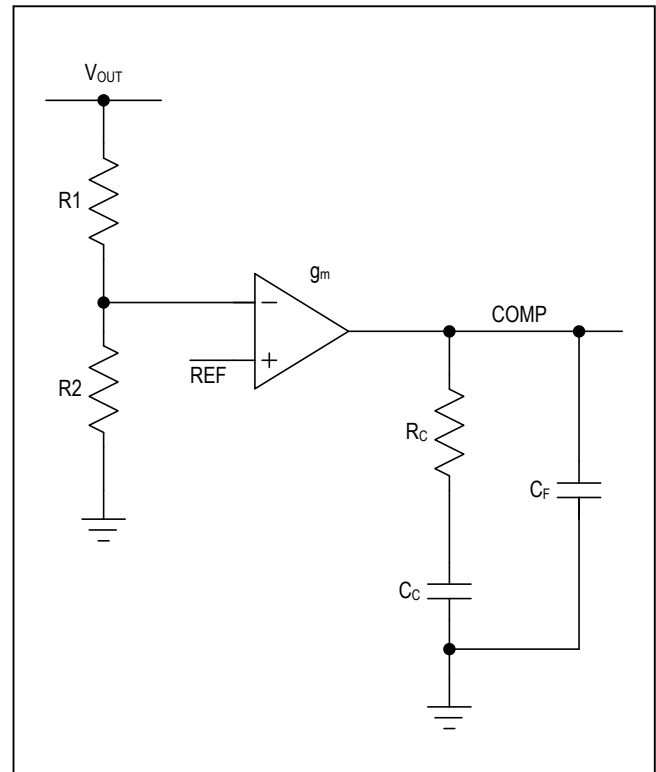

Figure 3. Compensation Network

A dominant pole ( $f_{pEA}$ ) is set by the compensation capacitor ( $C_C$ ) and the amplifier output resistance ( $R_{OUT\_EA}$ ). A zero ( $f_{zEA}$ ) is set by the compensation resistor ( $R_C$ ) and the compensation capacitor ( $C_C$ ). There is an optional pole ( $f_{pEA}$ ) set by  $C_F$  and  $R_C$  to cancel the output capacitor ESR zero if it occurs near the crossover frequency ( $f_C$ , where the loop gain equals 1 (0dB)). Thus:

$$f_{zEA} = \frac{1}{2\pi \times C_C \times R_C}$$

$$f_{pdEA} = \frac{1}{2\pi \times C_C \times (R_{OUT\_EA} + R_C)}$$

$$f_{pEA} = \frac{1}{2\pi \times C_F \times R_C}$$

The loop-gain crossover frequency ( $f_C$ ) should be set below 1/5 of the switching frequency and much higher than the power-modulator pole ( $f_{pMOD}$ )

$$f_{pMOD} \ll f_C \leq \frac{f_{SW}}{5}$$

The total loop gain as the product of the modulator gain, the feedback voltage divider gain, and the error amplifier gain at  $f_C$  should be equal to 1. So:

$$GAIN_{MOD}(f_C) \times \frac{V_{FB}}{V_{OUT}} \times GAIN_{EA}(f_C) = 1$$

For the case where  $f_{zMOD}$  is greater than  $f_C$ :

$$GAIN_{EA}(f_C) = g_{m,EA} \times R_C$$

Therefore:

$$GAIN_{MOD}(f_C) \times \frac{V_{FB}}{V_{OUT}} \times g_{m,EA} \times R_C = 1$$

Solving for  $R_C$ :

$$R_C = \frac{V_{OUT}}{g_{m,EA} \times V_{FB} \times GAIN_{MOD}(f_C)}$$

Set the error-amplifier compensation zero formed by  $R_C$  and  $C_C$  ( $f_{zEA}$ ) at the  $f_{pMOD}$ . Calculate the value of  $C_C$  as follows:

$$C_C = \frac{1}{2\pi \times f_{pMOD} \times R_C}$$

If  $f_{zMOD}$  is less than  $5 \times f_C$ , add a second capacitor ( $C_F$ ) from COMP to GND and set the compensation pole formed by  $R_C$  and  $C_F$  ( $f_{pEA}$ ) at the  $f_{zMOD}$ . Calculate the value of  $C_F$  as follows:

$$C_F = \frac{1}{2\pi \times f_{zMOD} \times R_C}$$

As the load current decreases, the modulator pole also decreases; however, the modulator gain increases accordingly and the crossover frequency remains the same. For the case where  $f_{zMOD}$  is less than  $f_C$ :

The power-modulator gain at  $f_C$  is:

$$GAIN_{MOD}(f_C) = GAIN_{MOD}(dc) \times \frac{f_{pMOD}}{f_{zMOD}}$$

The error-amplifier gain at  $f_C$  is:

$$GAIN_{EA}(f_C) = g_{m,EA} \times R_C \times \frac{f_{zMOD}}{f_C}$$

Therefore:

$$GAIN_{MOD}(f_C) \times \frac{V_{FB}}{V_{OUT}} \times g_{m,EA} \times R_C \times \frac{f_{zMOD}}{f_C} = 1$$

Solving for  $R_C$ :

$$R_C = \frac{V_{OUT} \times f_C}{g_{m,EA} \times V_{FB} \times GAIN_{MOD}(f_C) \times f_{zMOD}}$$

Set the error-amplifier compensation zero formed by  $R_C$  and  $C_C$  at the  $f_{pMOD}$  ( $f_{zEA} = f_{pMOD}$ ).

$$C_C = \frac{1}{2\pi \times f_{pMOD} \times R_C}$$

If  $f_{zMOD}$  is less than  $5 \times f_C$ , add a second capacitor  $C_F$  from COMP to ground. Set  $f_{pEA} = f_{zMOD}$  and calculate  $C_F$  as follows:

$$C_F = \frac{1}{2\pi \times f_{zMOD} \times R_C}$$



### PCB Layout Guidelines

Careful PCB layout is critical to achieve low switching losses and clean, stable operation. Use a multilayer board whenever possible for better noise immunity and power dissipation. Follow these guidelines for good PC board layout:

- 1) Use a large contiguous copper plane under the device package. Ensure that all heat-dissipating components have adequate cooling. The bottom pad of the devices must be soldered down to this copper plane for effective heat dissipation and getting the full power out of the devices. Use multiple vias or a single large via in this plane for heat dissipation
- 2) Isolate the power components and high current path from the sensitive analog circuitry. This is essential to prevent any noise coupling into the analog signals.
- 3) Keep the high-current paths short, especially at the ground terminals. This practice is essential for stable, jitter-free operation. The high current path comprising of input capacitor, high-side FET, inductor, and the output capacitor should be as short as possible.
- 4) Keep the power traces and load connections short. This practice is essential for high efficiency. Use thick copper PCBs (2oz vs. 1oz) to enhance full-load efficiency.
- 5) The analog signal lines should be routed away from the high-frequency planes. This ensures integrity of sensitive signals feeding back into the IC.
- 6) The ground connection for the analog and power section should be close to the IC. This keeps the ground current loops to a minimum. In cases where only one ground is used, adequate isolation between analog return signals and high-power signals must be maintained.

# MAX20002/MAX20003

36V, 220kHz to 2.2MHz, 2A/3A Fully Integrated Step-Down Converters with 15µA Operating Current

## Ordering Information

PART	V <sub>OUT</sub> ADJUSTABLE (FB TIED TO RESISTOR-DIVIDER) (V)	V <sub>OUT</sub> FIXED (FB TIED TO BIAS) (V)	MAXIMUM OPERATING CURRENT (A)	TEMP RANGE	PIN-PACKAGE	MINIMUM ILIM (A)
<b>MAX20002</b> ATPA/V+	1 to 10	5	2	-40°C to +125°C	20 TQFN-EP*	2.5
MAX20002ATPB/V+	1 to 10	3.3	2	-40°C to +125°C	20 TQFN-EP*	2.5
MAX20002CATPA/V+**	1 to 10	5	2	-40°C to +125°C	20 TQFN-EP*	2.5
MAX20002CATPB/V+**	1 to 10	3.3	2	-40°C to +125°C	20 TQFN-EP*	2.5
MAX20002CATPC/V+**	1 to 10	5	2	-40°C to +125°C	20 TQFN-EP*	5
MAX20002CATPD/V+**	1 to 10	3.3	2	-40°C to +125°C	20 TQFN-EP*	5
<b>MAX20003</b> ATPA/V+	1 to 10	5	3	-40°C to +125°C	20 TQFN-EP*	3.75
MAX20003ATPB/V+	1 to 10	3.3	3	-40°C to +125°C	20 TQFN-EP*	3.75
MAX20003CATPC/V+**	1 to 10	5	3	-40°C to +125°C	20 TQFN-EP*	5
MAX20003CATPD/V+**	1 to 10	3.3	3	-40°C to +125°C	20 TQFN-EP*	5

/V denotes an automotive qualified part.

+Denotes a lead(Pb)-free/RoHS-compliant package.

T = Tape and reel.

\*EP = Exposed pad.

\*\*Future product—contact factory for availability.

## Chip Information

PROCESS: BiCMOS

## Package Information

For the latest package outline information and land patterns (footprints), go to [www.maximintegrated.com/packages](http://www.maximintegrated.com/packages). Note that a "+", "#", or "-" in the package code indicates RoHS status only. Package drawings may show a different suffix character, but the drawing pertains to the package regardless of RoHS status.

PACKAGE TYPE	PACKAGE CODE	OUTLINE NO.	LAND PATTERN NO.
20 TQFN-EP	T2055+4C	<a href="#">21-0140</a>	<a href="#">90-0009</a>

## Revision History

REVISION NUMBER	REVISION DATE	DESCRIPTION	PAGES CHANGED
0	3/14	Initial release	—
1	5/14	Added overvoltage protection threshold spec to <i>Electrical Characteristics</i> table	5
2	2/15	Updated the <i>Benefits and Features</i> section	1
3	11/15	Added new package variants to <i>Electrical Characteristics</i> and <i>Ordering Information</i> tables	4, 5, 17
4	3/16	Changed land pattern number in <i>Package Information</i> table from 90-0010 to 90-0009	17
5	4/16	Updated <i>Ordering Information</i>	18
6	6/16	Removed MAX20003CATPA/V+ and MAX20003CATPB/V+ from <i>Ordering Information</i>	18

For pricing, delivery, and ordering information, please contact Maxim Direct at 1-888-629-4642, or visit Maxim Integrated's website at [www.maximintegrated.com](http://www.maximintegrated.com).

Maxim Integrated cannot assume responsibility for use of any circuitry other than circuitry entirely embodied in a Maxim Integrated product. No circuit patent licenses are implied. Maxim Integrated reserves the right to change the circuitry and specifications without notice at any time. The parametric values (min and max limits) shown in the *Electrical Characteristics* table are guaranteed. Other parametric values quoted in this data sheet are provided for guidance.

Компания «Океан Электроники» предлагает заключение долгосрочных отношений при поставках импортных электронных компонентов на взаимовыгодных условиях!

Наши преимущества:

- Поставка оригинальных импортных электронных компонентов напрямую с производств Америки, Европы и Азии, а так же с крупнейших складов мира;
- Широкая линейка поставок активных и пассивных импортных электронных компонентов (более 30 млн. наименований);
- Поставка сложных, дефицитных, либо снятых с производства позиций;
- Оперативные сроки поставки под заказ (от 5 рабочих дней);
- Экспресс доставка в любую точку России;
- Помощь Конструкторского Отдела и консультации квалифицированных инженеров;
- Техническая поддержка проекта, помощь в подборе аналогов, поставка прототипов;
- Поставка электронных компонентов под контролем ВП;
- Система менеджмента качества сертифицирована по Международному стандарту ISO 9001;
- При необходимости вся продукция военного и аэрокосмического назначения проходит испытания и сертификацию в лаборатории (по согласованию с заказчиком);
- Поставка специализированных компонентов военного и аэрокосмического уровня качества (Xilinx, Altera, Analog Devices, Intersil, Interpoint, Microsemi, Actel, Aeroflex, Peregrine, VPT, Syfer, Eurofarad, Texas Instruments, MS Kennedy, Miteq, Cobham, E2V, MA-COM, Hittite, Mini-Circuits, General Dynamics и др.);

Компания «Океан Электроники» является официальным дистрибьютором и эксклюзивным представителем в России одного из крупнейших производителей разъемов военного и аэрокосмического назначения «JONHON», а так же официальным дистрибьютором и эксклюзивным представителем в России производителя высокотехнологичных и надежных решений для передачи СВЧ сигналов «FORSTAR».



## JONHON

«JONHON» (основан в 1970 г.)

Разъемы специального, военного и аэрокосмического назначения:

(Применяются в военной, авиационной, аэрокосмической, морской, железнодорожной, горно- и нефтедобывающей отраслях промышленности)

«FORSTAR» (основан в 1998 г.)

ВЧ соединители, коаксиальные кабели,  
кабельные сборки и микроволновые компоненты:

(Применяются в телекоммуникациях гражданского и специального назначения, в средствах связи, РЛС, а так же военной, авиационной и аэрокосмической отраслях промышленности).



Телефон: 8 (812) 309-75-97 (многоканальный)

Факс: 8 (812) 320-03-32

Электронная почта: [ocean@oceanchips.ru](mailto:ocean@oceanchips.ru)

Web: <http://oceanchips.ru/>

Адрес: 198099, г. Санкт-Петербург, ул. Калинина, д. 2, корп. 4, лит. А