

K12 High Performance Key Switches

Features/Benefits

- Excellent tactile feel
- Wide choice of LED colors, travel and actuator forces
- High reliability / long life
- Sealed version available
- Designed for low-level switching
- Double stroke version available
- Detector version available

Typical Applications

- Automotive
- Off-road transportation
- Industrial electronics
- Computers & network equipment
- Joysticks



Construction:

FUNCTION: momentary
 DISTANCE BETWEEN BUTTON CENTERS:
 min. 11 (0.433) K12C = 13 (0.512)
 TERMINALS: PC pins, tinned
 MOUNTING: Locating pins; K12G and K12P additionally
 with snap-in housing

Mechanical

TOTAL TRAVEL: 1 mm, 1.5 mm, 2 mm
 SWITCHING TRAVEL: 0.6 mm*
 OPERATING FORCE: 1.5 N OD without snap-point as detector
 switch, 2.5 N, 3.5 N, 5 N, 3.5/7 N, 6/12 N. Additional
 operating force 7N, 9N and 20N, available on request.
 PROTECTION CLASS: K12C IP 67 (dust tight, protected against
 the effects of immersion in water; other versions IP 40)

* Additional switching travel (with pre-travel) available by request.

Packaging

Bulk in boxes of 250 pieces (version C or GO) or
 300 pieces (version A, AL, P or PL)

Electrical

SWITCHING POWER MIN./MAX.: 0.02mW/3 W
 SWITCHING VOLTAGE MIN./MAX.: 2 V DC / 30 V DC
 SWITCHING CURRENT MIN./MAX.: 10 mA /100 mA
 DIELECTRIC STRENGTH (50 Hz, 1 min): ≥ 500 V
 OPERATING LIFE with max. switching power: ≥ 10⁶ operations
 K12G & K12GO; operating life of second switch 5 x 10⁴ operations,
 operating life K12C and version with more than 6N (7N, 9N 20N)
 please consult factory.
 CONTACT RESISTANCE: Initial ≤ 50 mΩ
 INSULATION RESISTANCE: ≥ 10¹⁰ Ω
 BOUNCE TIME: ≤ 1 ms
 Operating speed 100 mm/s (3.94/s)

Environmental

OPERATING TEMPERATURE: -40°C to 85°C.
 STORAGE TEMPERATURE: -40°C to 95°C.

Process

SOLDERABILITY:
 Wave soldering, compatible with lead free soldering profile
 Hand soldering, 350°C

How To Order

Our easy build-a-switch concept allows you to mix and match options to create the switch you need. To order, select desired option from each category and place it in the appropriate box.

Note: Some of the configurations may not be available or could require some development.

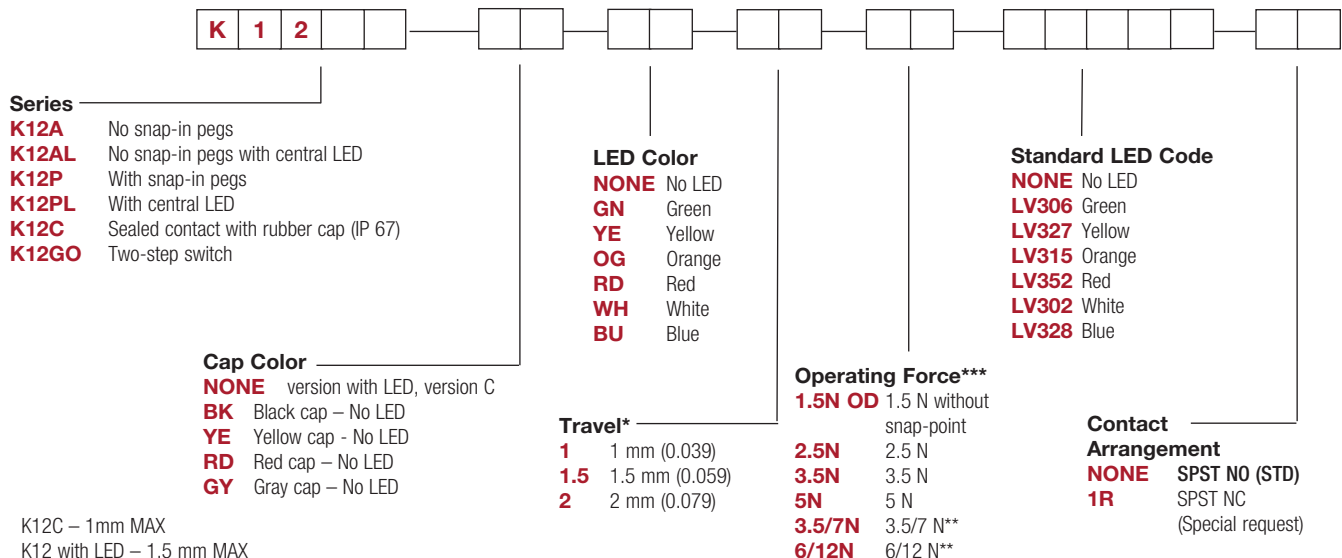

* K12C – 1mm MAX
 K12 with LED – 1.5 mm MAX
 ** K12G & K12GO version only
 *** Additional operating force: 7N, 9N available on request

K12 High Performance Key Switches

SERIES

K12A without snap in



PCB LAYOUT, MOUNTING SIDE

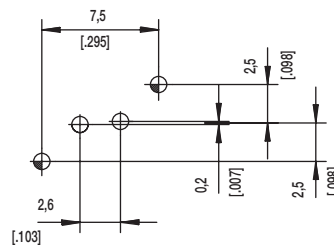

K12AL



PCB LAYOUT, MOUNTING SIDE

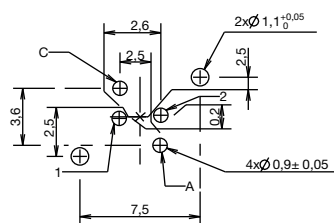

ELECTRICAL GRAPH



	$1,1^{+0,05}$	2x	2x	center hole		
	$0,9 \pm 0,05$		2x	LED	$\varnothing 0,5 (,020)$	Sn
		2x	2x	switch	$0,7 \times 0,2 (,028 \times 0,081)$	Sn
Hole	\varnothing	Without	with LED	Description	Terminal Section	Surface



Key Switches

K12 High Performance Key Switches

SERIES

K12P with snap in



PCB LAYOUT, MOUNTING SIDE



center of actuation area (notice LED)

Hole	Ø	Without LED	Description	Terminal Section	Surface
	1,7 (.069)	2x	snap-in		
	1,6 (.062)	1x	coding hole (L,M,N)		
	1,1 (.043)	2x	center hole		Sn
	0,9 (.035)	2x	switch	0.7 x 0.2 (.028 x .081)	Sn

K12PL



PCB LAYOUT, MOUNTING SIDE

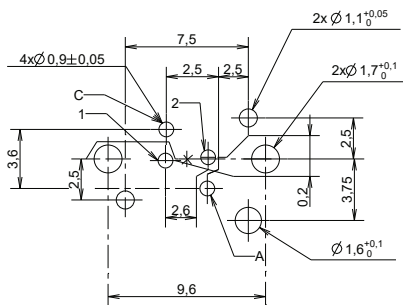

ELECTRICAL GRAPH



Hole	Ø	Without LED	Description	Terminal Section	Surface
	1,7 (.069)	2x	snap-in		
	1,6 (.062)	1x	coding hole (L,M,N)		
	1,1 (.043)	2x	center hole		Sn
	0,9 (.035)	2x	LED	m0.5 (.020)	Sn
	0,9 (.035)	2x	switch	0.7 x 0.2 (.028 x .081)	Sn



First Angle Projection



Key Switches

K12 High Performance Key Switches

SERIES 

K12C SEALED CONTACT WITH RUBBER CAP (IP 67)

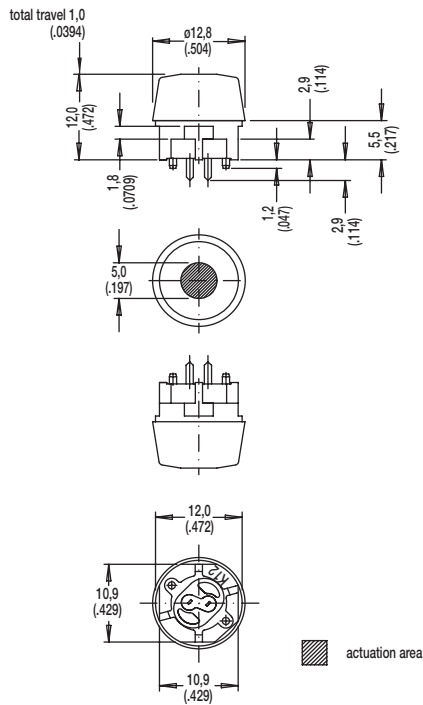

PCB LAYOUT, MOUNTING SIDE

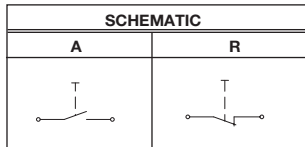
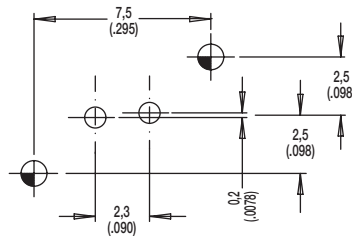

Hole	Ø	Without LED	Description	Terminal Section	Surface
	1,1 (.043)	2x	center hole		
	0,9 (.035)	2x	switch	0.7 x 0.2(.0275 x .0787)	Sn



D

Key Switches

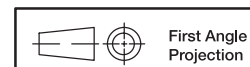

First Angle
Projection

Dimensions are shown: mm
Specifications and dimensions subject to change

K12 High Performance Key Switches

SERIES

K12GO



PCB LAYOUT, MOUNTING SIDE



Hole	Ø	Without LED	Description	Terminal Section	Surface
	1,7 (.069)	2x	snap-in		
	1,6 (.062)	1x	code		
	0,9 (.035)		LED	m0.5 (.020)	Sn
		2x	switch 2	0.7 x 0.3 (.028 x .012)	Sn
		2x	switch 1	0.7 x 0.2 (.028 x .081)	Sn



Dimensions are shown: mm
Specifications and dimensions subject to change

K12 High Performance Key Switches

CAP COLOR

OPTION CODE	COLOR
NONE	Version with LED
BK	Black - no LED
YE	Yellow - no LED
RD	Red - no LED
GY	Gray - no LED

LED COLOR

OPTION CODE	COLOR
NONE	Models without LED
GN	Green
YE	Yellow
OG	Orange
RD	Red
WH	White
BU	Blue

STANDARD LED CODE	COLOR
NONE	Models without LED
LV306	Green
LV327	Yellow
LV315	Orange
LV352	Red
LV302	White
LV328	Blue

TRAVEL

- 1** 1 mm
- 1.5** 1.5 mm
- 2** 2 mm

OPERATING FORCE

OPTION CODE	OPERATING FORCE
1.5N OD	1.5 N, 150g without snap-point
2.5N	2.5 N, 250g
3.5N	3.5 N, 350g
5N	5 N, 500g
3.5/7N	3.5/7 N, 350/700g
6/12N	6/12 N, 600-1200g

CONTACT ARRANGEMENT OPTION

1R SPST NC (SPECIAL REQUEST FOR NORMALLY CLOSED OPTION)



First Angle
Projection

Dimensions are shown: mm
Specifications and dimensions subject to change

Компания «Океан Электроники» предлагает заключение долгосрочных отношений при поставках импортных электронных компонентов на взаимовыгодных условиях!

Наши преимущества:

- Поставка оригинальных импортных электронных компонентов напрямую с производств Америки, Европы и Азии, а так же с крупнейших складов мира;
- Широкая линейка поставок активных и пассивных импортных электронных компонентов (более 30 млн. наименований);
- Поставка сложных, дефицитных, либо снятых с производства позиций;
- Оперативные сроки поставки под заказ (от 5 рабочих дней);
- Экспресс доставка в любую точку России;
- Помощь Конструкторского Отдела и консультации квалифицированных инженеров;
- Техническая поддержка проекта, помощь в подборе аналогов, поставка прототипов;
- Поставка электронных компонентов под контролем ВП;
- Система менеджмента качества сертифицирована по Международному стандарту ISO 9001;
- При необходимости вся продукция военного и аэрокосмического назначения проходит испытания и сертификацию в лаборатории (по согласованию с заказчиком);
- Поставка специализированных компонентов военного и аэрокосмического уровня качества (Xilinx, Altera, Analog Devices, Intersil, Interpoint, Microsemi, Actel, Aeroflex, Peregrine, VPT, Syfer, Eurofarad, Texas Instruments, MS Kennedy, Miteq, Cobham, E2V, MA-COM, Hittite, Mini-Circuits, General Dynamics и др.);

Компания «Океан Электроники» является официальным дистрибьютором и эксклюзивным представителем в России одного из крупнейших производителей разъемов военного и аэрокосмического назначения «JONHON», а так же официальным дистрибьютором и эксклюзивным представителем в России производителя высокотехнологичных и надежных решений для передачи СВЧ сигналов «FORSTAR».



JONHON

«JONHON» (основан в 1970 г.)

Разъемы специального, военного и аэрокосмического назначения:

(Применяются в военной, авиационной, аэрокосмической, морской, железнодорожной, горно- и нефтедобывающей отраслях промышленности)

«FORSTAR» (основан в 1998 г.)

ВЧ соединители, коаксиальные кабели,
кабельные сборки и микроволновые компоненты:

(Применяются в телекоммуникациях гражданского и специального назначения, в средствах связи, РЛС, а так же военной, авиационной и аэрокосмической отраслях промышленности).



Телефон: 8 (812) 309-75-97 (многоканальный)

Факс: 8 (812) 320-03-32

Электронная почта: ocean@oceanchips.ru

Web: <http://oceanchips.ru/>

Адрес: 198099, г. Санкт-Петербург, ул. Калинина, д. 2, корп. 4, лит. А