



MALLORY SONALERT PRODUCTS, INC.



Product APPLICATION Guide

Product Application Guide- 22mm Industrial Alarms with Terminal Block

Part Number Structure

ZA 016 L D CT

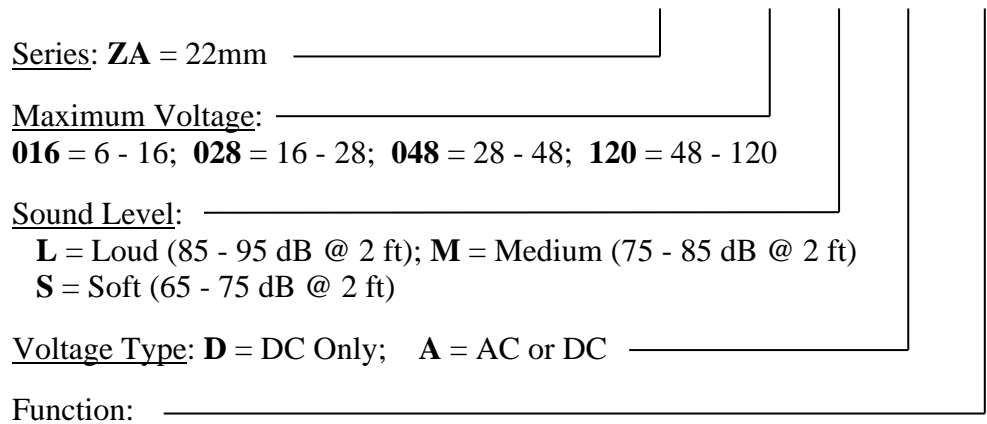

- CT** = Continuous Tone; **FP1** = Fast Pulse; **MP1** = Medium Pulse
- SP1** = Slow Pulse; **DP2** = Fast Double Pulse; **DP3** = Slow Double Pulse
- PS1** = Short Pulse Tone
- DL1** = 10 Sec. Delay; **SS1** = 1 Min On-Time; **SU2** = Fast Speed-Up
- CM1** = Chime Tone
- DT7** = Fast Warble; **DT8** = Slow Warble
- SR8** = Fast Siren; **SR9** = Slow Siren
- MT1** Thru **MT8** = Multi-Tones

Sound Descriptions

- Continuous Tone: Constant tone until voltage is removed
- Fast Pulse Tone: 10 pulses per second
- Medium Pulse Tone: 5 pulses per second
- Slow Pulse Tone: 1 pulse per second
- Fast Double Pulse Tone: 1 double beep every half second
- Slow Double Pulse Tone: 1 double beep every 2 seconds
- Short Pulse Tone: 1 beep per second (on for 0.1 sec / off for 0.9 sec)
- 10 Sec. Delay: Wait 10 seconds before issuing continuous tone
- 1 Min On-Time: Issue continuous tone for 1 minute and then turn off
- Fast Speed-Up: Over 30 sec's, speed up from 1 beep per 2 sec's to 8 beeps per sec
- Chime Tone: Repeating chime sound at 1 chime every three seconds
- Fast Warble: Alternate between two frequencies at 7 warbles per second
- Slow Warble: Alternate between two frequencies at 1.5 warbles per second
- Fast Siren: Sweeping siren sound at 5 sweeps per second
- Slow Siren: Sweeping siren sound at 2 sweeps per second
- Multi-Tone: Four different tones in one package. See below table for list of sounds.

Mounting Instructions:

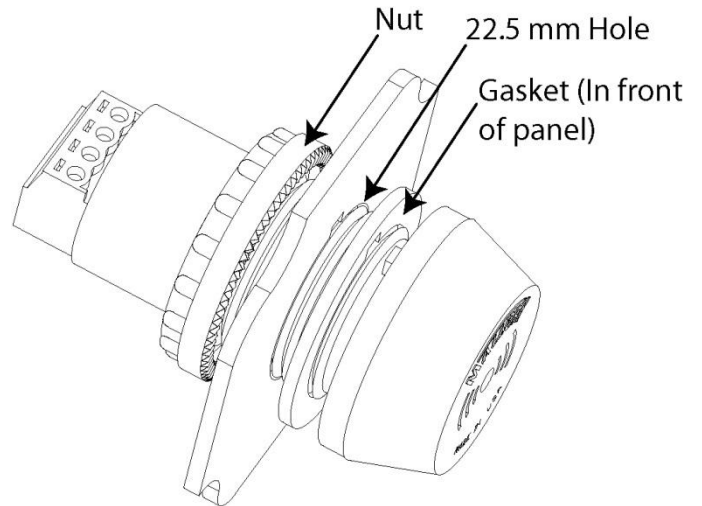
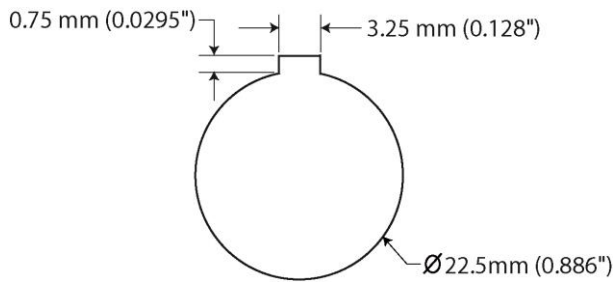

Panel Hole Cut

- **Panel Hole Size:** 22.5 mm with Keyway
- **Maximum Panel Thickness:** 12.7 mm (0.5 in)
- **Maximum Nut Torque:** 10 in-lbs (1.13 n-m)

Electrical Connection:

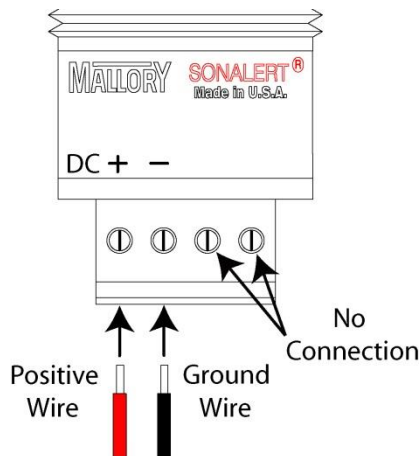

DC ONLY

AC/DC

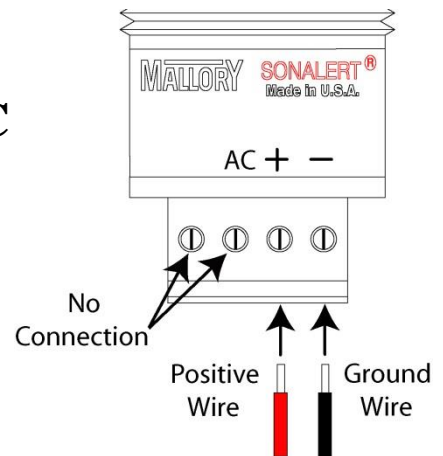

- **Wire Strip Length:** 6.5 mm (0.256 in)
- **Wire Size:** 30 to 16 AWG
- **Maximum Screw Torque:** 2 in-lbs (0.226 n-m)

Certifications:

- **RoHS; UL; cUL; NEMA 3R/4X/12; IP-66; CSA 22.2 No. 94**
 - Included gasket must be used to maintain NEMA 3R/4X/12 ratings.

cUL On-Line Listing:

UCST8.S1290 - AUDIBLE-SIGNAL APPLIANCES, GENERAL SIGNAL CERTIFIED FOR CANADA - COMPONENT

DETAILS

File No.: S1290

UL Category (CCN): [UCST8.q](#)

Document Type: Listing

Parent Category (CCN): [UCCV8.q](#)

Document Company Information

Audible-signal Appliances, General Signal Certified for Canada - Component

See General Information for Audible-signal Appliances, General Signal Certified for Canada - Component

S1290

MALLORY SONALERT PRODUCTS INC

4411 S High School Rd
Indianapolis, IN 46241-6404 USA

Audible tone generator gaskets, Model(s) ACC03(®)

Audible tone generators, Model(s) PF-35A29EP-48, PF-35A29EP-48V, PK-35A29EP-48V, PK-35A29EP-48, PK-35N29EP-48, PL-35A29EP-48V, PL-35A29EP-48V, SBM428(®), SC105(®), (F7)*, SC110(F5)(®), (F7)*, SC250(F5)(®), (F7)*, SC307N(®), (F7)*, SC416(®), (F7)*, SC616(F4)(®), (F7)*, SC628(F1)(®), (F7)*, SC648(F2)(®), (F7)*, SCE uuu v w x yyy z(®), SCL uuu v w x yyy z(®), SNA428(®), STA0504CT, STA05204, STA05204-ST, STA05204CT, STA05204F, VSB110-1, (F7), VSB110-1L, (F7), VSB110-2, (F7), VSB110-2L, (F7), ZA aaa b c ddd (®)

(F1) - May also be followed by A, AD, AJ, AN, ANI, ANP, AP, D, DI, DP, H, HI, HP, J, L, N, NL, P, -98 or -BTR

(F2) - May also be followed by A, AD, AJ, AN, AP, D, S or -BTR

(F3) - May also be followed CP, D, DI, DP, H, J, K, N, NJ, NP, P, Q or -BTR

(F4) - May also be followed by CP, CPN, N, NJ, NL, NP or -BTR

(F5) - May also be followed by D, J, N, P or -BTR

(F6) - May also be followed by R.

(F7) - May be used in conjunction with neoprene gasket P/N ACC03 in order to maintain the enclosure integrity of a Type 3R, 4X, or 12 enclosure. (Classic Model Series SC, SCE, SCL, and VSB only).

(R8) - May be used in conjunction with Classic Model Series SC & VSB audible signal devices in order to maintain the enclosure integrity of a Type 3R, 4X, or 12 enclosure.

(R9) - Must be used with neoprene gasket type 4216-S to maintain enclosure NEMA Type Ratings 3R, 4X and 12.

aaa - Indicates voltage rating. May be 016, 028, 048 or 120.

b - Indicates sound level. May be L, M or S.

c - Indicates voltage type. May be A or D.

ddd - Indicates Sound Function. May be any combination of letters A through Z and/or numbers 0 through 9.

uuu - 016, 028, 048, or 120.

v - X, L, M, or S.

w - A or D.

x - 0, 1, 2, 3, 4, 5, 6, 7, 8, or 9.

yyy - Any combination of letters A through Z and/or numbers 0 through 9.

z - B, F, S, or W.

Marking: Company name or trademark "Mallory", "Sonalert", model designation and the Recognized Component Mark for Canada 

Last Updated on 2019-08-29

The appearance of a company's name or product in this database does not in itself assure that products so identified have been manufactured under UL's Follow-Up Service. Only those products bearing the UL Mark should be considered to be Certified and covered under UL's Follow-Up Service. Always look for the Mark on the product. UL permits the reproduction of the material contained in the Online Certification Directory subject to the following conditions: 1. The Guide Information, Assemblies, Constructions, Designs, Systems, and/or Certifications (files) must be presented in their entirety and in a non-misleading manner, without any manipulation of the data (or drawings); 2. The statement: "Reprinted from the Online Certifications Directory with permission from UL" must appear adjacent to the extracted material. In addition, the reprinted material must include a copyright notice in the following format: "© 2019 UL LLC"

UL On-line Listing:

UCST2.S1290 - AUDIBLE-SIGNAL APPLIANCES, GENERAL SIGNAL - COMPONENT

DETAILS

File No.: S1290

UL Category (CCN): [UCST2.q](#)

Document Type: Listing

Parent Category (CCN): [UCCV2.q](#)

Document Company Information

Audible-signal Appliances, General Signal - Component

See General Information for Audible-signal Appliances, General Signal - Component

S1290

MALLORY SONALERT PRODUCTS INC

4411 S High School Rd
Indianapolis, IN 46241-6404 USA

Audible tone generator gaskets, Model(s) ACC03(®)

Audible tone generators, Model(s) PF-35A29EP-48, PF-35A29EP-48V, PK-35A29EP-48V, PK-35A29EP-48, PK-35N29EP-48, PL-35A29EP-48V, PL-35A29EP-48V, SBM428(®), SC105(®), (F7)*, SC110(F5)(®), (F7)*, SC250(F5)(®), (F7)*, SC307N(®), (F7)*, SC416(®), (F7)*, SC616(F4)(®), (F7)*, SC628(F1)(®), (F7)*, SC648(F2)(®), (F7)*, SCE uuu v w x yyy z(®), SCL uuu v w x yyy z(®), SNA428(®), STA0504CT, STA05204, STA05204-ST, STA05204CT, STA05204F, VSB110-1, (F7), VSB110-1L, (F7), VSB110-2, (F7), VSB110-2L, (F7), ZA aaa b c ddd (®)

(F1) - May also be followed by A, AD, AJ, AN, ANI, ANP, AP, D, DI, DP, H, HI, HP, J, L, N, NL, P, -98 or -BTR

(F2) - May also be followed by A, AD, AJ, AN, AP, D, S or -BTR

(F3) - May also be followed CP, D, DI, DP, H, J, K, N, NJ, NP, P, Q or -BTR

(F4) - May also be followed by CP, CPN, N, NJ, NL, NP or -BTR

(F5) - May also be followed by D, J, N, P or -BTR

(F6) - May also be followed by R.

(F7) - May be used in conjunction with neoprene gasket P/N ACC03 in order to maintain the enclosure integrity of a Type 3R, 4X, or 12 enclosure. (Classic Model Series SC, SCE, SCL, and VSB only).

(R8) - May be used in conjunction with Classic Model Series SC & VSB audible signal devices in order to maintain the enclosure integrity of a Type 3R, 4X, or 12 enclosure.

(R9) - Must be used with neoprene gasket type 4216-S to maintain enclosure NEMA Type Ratings 3R, 4X and 12.

aaa - Indicates voltage rating. May be 016, 028, 048 or 120.

b - Indicates sound level. May be L, M or S.

c - Indicates voltage type. May be A or D.

ddd - Indicates Sound Function. May be any combination of letters A through Z and/or numbers 0 through 9.

uuu - 016, 028, 048, or 120.

v - X, L, M, or S.

w - A or D.

x - 0, 1, 2, 3, 4, 5, 6, 7, 8, or 9.

yyy - Any combination of letters A through Z and/or numbers 0 through 9.

z - B, F, S, or W.

Marking: Company name or trademark "Mallory", "Sonalert" and model designation.

Last Updated on 2019-08-29

The appearance of a company's name or product in this database does not in itself assure that products so identified have been manufactured under UL's Follow-Up Service. Only those products bearing the UL Mark should be considered to be Certified and covered under UL's Follow-Up Service. Always look for the Mark on the product. UL permits the reproduction of the material contained in the Online Certification Directory subject to the following conditions: 1. The Guide Information, Assemblies, Constructions, Designs, Systems, and/or Certifications (files) must be presented in their entirety and in a non-misleading manner, without any manipulation of the data (or drawings); 2. The statement: "Reprinted from the Online Certifications Directory with permission from UL" must appear adjacent to the extracted material. In addition, the reprinted material must include a copyright notice in the following format: "© 2019 UL LLC"

Sound Level vs Distance:

Various Measurement Distances	ZA Series Sound Level Category		
	Loud 85 – 95 dB @ 2 ft	Medium 75 – 85 dB @ 2 ft	Soft 65 – 85 dB @ 2 ft
10 cm (4 in)	100 to 110 dB	90 to 100 dB	80 to 90 dB
30 cm (1 ft)	91 to 101 dB	81 to 91 dB	71 to 81 dB
1 Meter	82 to 92 dB	72 to 82 dB	62 to 72 dB
10 ft	71 to 81 dB	61 to 71 dB	51 to 61 dB

- The ZA Series of 22mm alarms measures sound level at 2 feet. Since sound level drops over distance, the above chart lists the equivalent sound levels at various distances.
- For example, if the Mallory part is in the **LOUD** sound level category, it has a sound level of 85 to 95 dB at 2 feet. At 10 cm, the sound level would measure 100 to 110 dB.

Packaging:

- Standard orders are bulk packed.

Accessories & Replacement Parts:

Part Number	Description	Notes
22MMGASKET	Replacement NEMA Gasket	Gasket comes with part
22MMNUT	Replacement Nut	Nut comes with part

Piezoelectric Electronic Alarm Construction

Piezoelectric Audible Signal Basic Construction

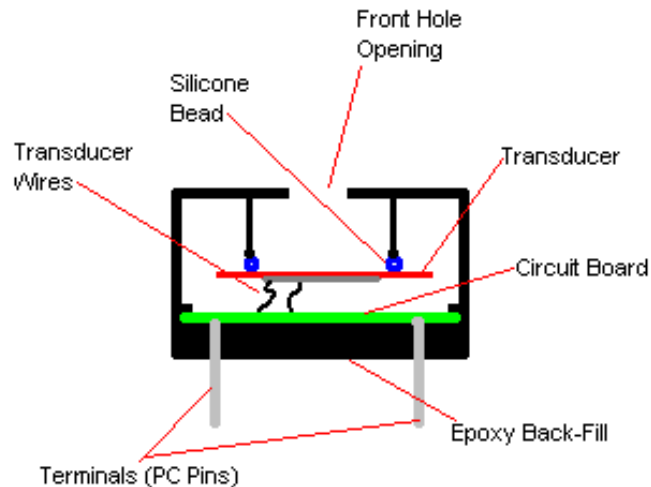

The above cross section picture shows the basic elements used in a piezoelectric audible alarm. The area in front of the transducer element including the front hole opening forms an acoustic cavity that lets the sound radiate out with the most efficiency (i.e. loudest sound level). If the alarm is an indicator that contains a circuit board, the circuit board is attached to the piezoelectric sounder element via soldered wires.

The above picture can be interpreted to represent a board mount package with pc pin terminations, but the same concept is used when building audible alarms in other mounting configurations such as SMT, Flange Mount, and Panel Mount alarms.

If the back of the alarm is sealed with epoxy or other material, the “guts” of the alarm (including the circuit board and components) are protected against fluid intrusion. However, fluid sitting inside the front cavity can obstruct the operation of the device causing the sound level to decrease significantly. If you need to wash the alarms after a soldering operation, it is strongly recommended to use an alarm that comes with a wash label that keeps the washing fluid from getting inside of the front cavity.

Operation of Piezoelectric Audible Alarms

Piezoelectric electronic audible alarms work by converting the user input voltage to an appropriate oscillating signal that is applied to a sounder element that is mounted in a housing. The piezoelectric sounder element consists of a metal disc that has a special ceramic material



bonded to it that physically bends when voltage is applied to it.

The above picture shows a bare piezoelectric sounder element. By applying a sinusoidal wave-form at an appropriate frequency, the transducer will physically deflect in one direction and then in the opposite direction following the shape of the input wave-form. If this oscillation occurs in the audible frequency range (1 Hz to 20 kHz), then air pressure waves are produced that the human ear interprets as an audible sound.

The larger the voltage of the applied wave-form, the larger the amplitude of the air pressure waves resulting in a louder sound level. However, the ceramic portion of the transducer can only bend so far before there is a risk of a catastrophic failure. This maximum voltage is somewhere around 40 to 50 volts. However, it is rare to apply this much voltage to a transducer as you reach a point of diminishing returns for voltages much greater than 32 volts.

By itself, the sound level produced by a transducer element is insignificant. To increase the size of the air pressure waves (and thus the sound level), the transducer element must be mounted inside an acoustic chamber that is optimized for the transducer size and resonant frequency. Every transducer has one frequency where it flexes more efficiently producing the louder sound levels. This frequency where the transducer performs the best is called the resonant frequency.

Self-Drive type devices provide a 3rd terminal that connects to an isolated portion of the piezoelectric transducer. This third terminal provides a feed-back signal that is 180 degrees out of phase with the drive signal. This signal can be fed back into the circuit to allow the sounder element to self-tune itself to the transducer's resonant frequency.

Decibel Sound Level Scale

The decibel sound level scale is an arbitrary scale that ranges from 0 dB (threshold of hearing) to 130 dB (threshold of pain). The chart below shows where some common sounds fall on this dB scale. Audible alarms are available that have sound levels as soft as 55 dB at 2 feet and as loud as 110 dB at 2 feet.

Reference Sound Levels

(as if you were standing 2 feet from the sound source)

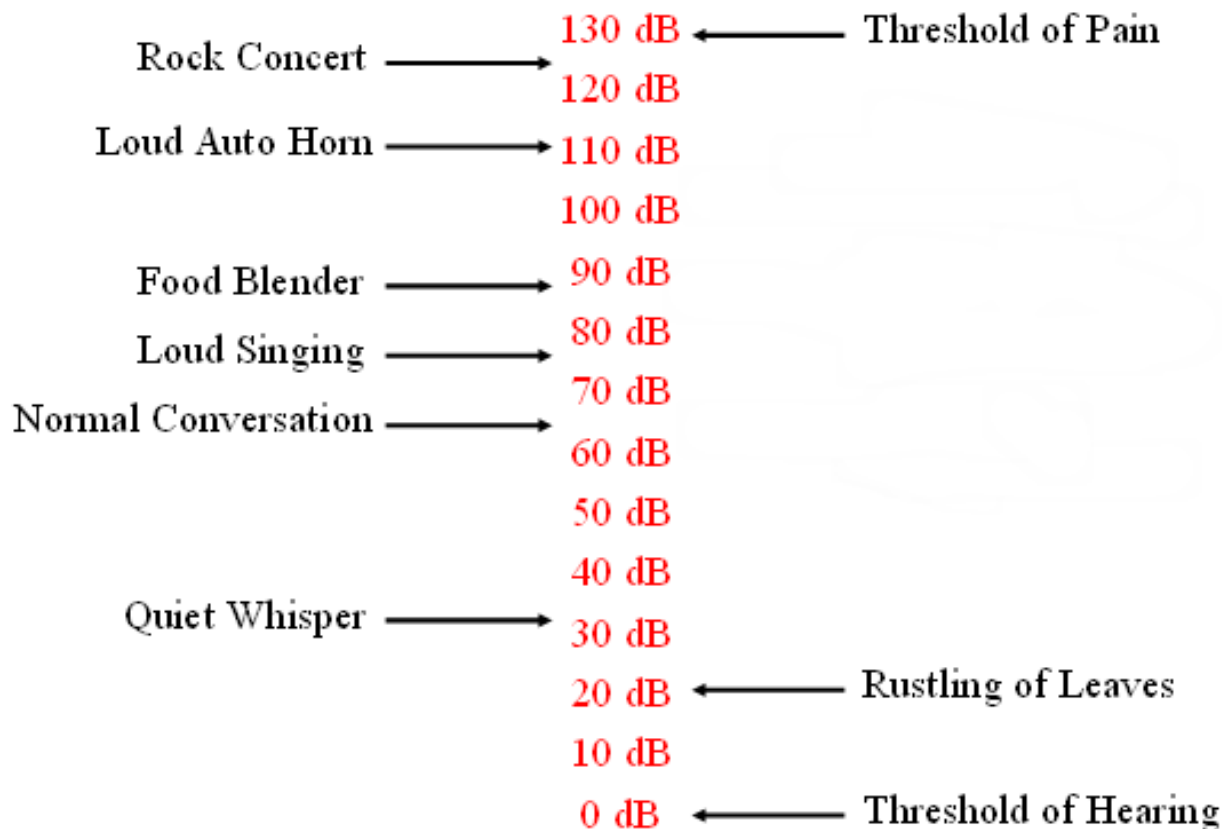

Fundamental Frequency & Harmonics

Below is a frequency scan of a piezoelectric audible alarm that has a resonant frequency of 2,800 Hz. As you can see, there is a strong frequency peak at 2.8 kHz and several smaller frequency peaks that follow called harmonic frequencies. The table below the chart shows that the size of the harmonic frequencies are significantly smaller than the fundamental frequency for this particular alarm unit. Because this alarm has a large fundamental frequency and much smaller harmonic frequencies, the sound quality of this part will be very good. When this alarm is activated, the listener will hear one clear frequency (also called sound pitch) from the alarm. Other electronic alarm technologies such as electro-magnetic or electro-mechanical type alarms often have much larger harmonic frequency components resulting in less clear tone.

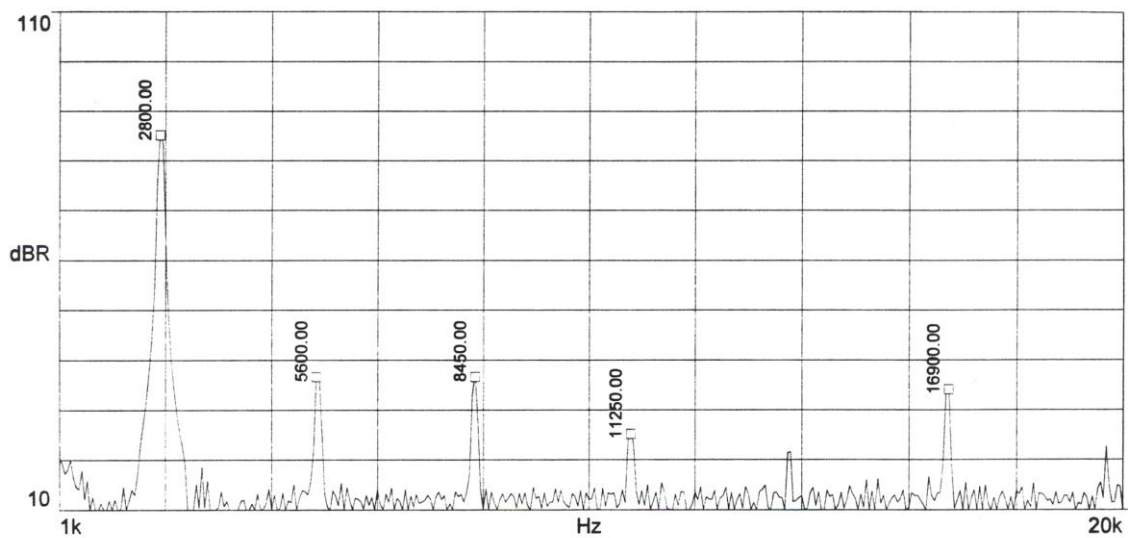

	Frequency	dB	% dB of Fundamental
Fundamental:	2.800 KHz	86.1	100.0%
2nd Harmonic:	5.600 KHz	37.6	43.7%
3rd Harmonic:	8.450 KHz	37.6	43.7%
4th Harmonic:	11.250 KHz	26.1	30.3%

Typical Failure Modes of Piezoelectric Audible Alarms

Component/Subsystem	Failure Mode	End Result	Occurrence
Circuit Components (Resistors, Capacitors, Diodes, IC's, etc.)	Over-voltage by customer's application	Unit ceases working.	Vast Majority of Returns
Transducer/Wire Solder Operation	Not enough wire strands in solder joint	Wire breaks after period of time & unit ceases sounding	Rare
Physical Assembly	Transducer wire pinched, adhesive/epoxy run down onto transducer, or RTV adhesive seal failure	Intermittent operation	Rare
Soldering Operation	Incorrect Solder Temperature or Time Causing Cold Solder Joint	Intermittent operation or unit ceases working after period of time	Very Rare
Circuit Components	Random Component Failure; Wrong Component Used; Missing Component	Unit ceases working under normal operating conditions	Very Rare
Transducer Wire	Defect in Wire; Wire Strands Damaged in Production	Wire breaks after period of time & unit ceases sounding	Very Rare
Piezo Transducer	Incorrect Polarization by Manufacturer; Glue Bonding Failure	Sound volume level decreases over time.	Exceedingly Rare

Notes:

1. Customer returns of Mallory audible alarms for failure to operate are very rare. Of the few parts returned each year, the vast majority of the root cause of failure is an over-voltage or voltage spike condition caused by the customer's application.
2. All Mallory alarms are, at a minimum, function tested 100% during production, and a final audit is performed. Mallory SC/SBM/SBT/SBS/SNP/LSC/VSB/MSR/MSO/ZA series of alarms are audited 100% at final test by checking that sound level, frequency, and current are within specification limits from 2 to 4 different voltage levels.

Компания «Океан Электроники» предлагает заключение долгосрочных отношений при поставках импортных электронных компонентов на взаимовыгодных условиях!

Наши преимущества:

- Поставка оригинальных импортных электронных компонентов напрямую с производств Америки, Европы и Азии, а так же с крупнейших складов мира;
- Широкая линейка поставок активных и пассивных импортных электронных компонентов (более 30 млн. наименований);
- Поставка сложных, дефицитных, либо снятых с производства позиций;
- Оперативные сроки поставки под заказ (от 5 рабочих дней);
- Экспресс доставка в любую точку России;
- Помощь Конструкторского Отдела и консультации квалифицированных инженеров;
- Техническая поддержка проекта, помощь в подборе аналогов, поставка прототипов;
- Поставка электронных компонентов под контролем ВП;
- Система менеджмента качества сертифицирована по Международному стандарту ISO 9001;
- При необходимости вся продукция военного и аэрокосмического назначения проходит испытания и сертификацию в лаборатории (по согласованию с заказчиком);
- Поставка специализированных компонентов военного и аэрокосмического уровня качества (Xilinx, Altera, Analog Devices, Intersil, Interpoint, Microsemi, Actel, Aeroflex, Peregrine, VPT, Syfer, Eurofarad, Texas Instruments, MS Kennedy, Miteq, Cobham, E2V, MA-COM, Hittite, Mini-Circuits, General Dynamics и др.);

Компания «Океан Электроники» является официальным дистрибьютором и эксклюзивным представителем в России одного из крупнейших производителей разъемов военного и аэрокосмического назначения «JONHON», а так же официальным дистрибьютором и эксклюзивным представителем в России производителя высокотехнологичных и надежных решений для передачи СВЧ сигналов «FORSTAR».



JONHON

«JONHON» (основан в 1970 г.)

Разъемы специального, военного и аэрокосмического назначения:

(Применяются в военной, авиационной, аэрокосмической, морской, железнодорожной, горно- и нефтедобывающей отраслях промышленности)

«FORSTAR» (основан в 1998 г.)

ВЧ соединители, коаксиальные кабели,
кабельные сборки и микроволновые компоненты:

(Применяются в телекоммуникациях гражданского и специального назначения, в средствах связи, РЛС, а так же военной, авиационной и аэрокосмической отраслях промышленности).



Телефон: 8 (812) 309-75-97 (многоканальный)

Факс: 8 (812) 320-03-32

Электронная почта: ocean@oceanchips.ru

Web: <http://oceanchips.ru/>

Адрес: 198099, г. Санкт-Петербург, ул. Калинина, д. 2, корп. 4, лит. А