

# 1-Channel 190mA Charge Pump White LED Driver with 1-wire Serial Interface



## BD1603NUV

### ●General Description

The high-power (large current output) type LED driver is a white LED driver best suited for applications that require the large current. It is equipped with output voltage and oscillation frequency switch functions to flexibly cope with a wide variety of applications. Because output voltage is fixed at 4.5V or 5.0V, it is also applicable to applications except the LED driver.

### ●Features

- Current consumption less than or equal to 2μA at shut-down
- Low ripple output owing to a complementary charge pump circuit
- Over current protection when VOUT short to GND.
- Soft start function
- Mounting various protection functions such as current overload limiter and thermal shut-down circuit

### ●Lineup

Parameter	BD1603NUV
Number of LEDs	Up to 10 LEDs (Up to maximum load current)
Boost magnification	x2 fixed (4.5V or 5.0V <sub>OUT</sub> put)
Interface	Control via external pins
Individual LED lighting	Not available

### ●Key Specifications

- Operating power supply voltage range: 2.7V to 5.5V
- Oscillator frequency: 238 or 642kHz(Typ.)
- Operating temperature range: -30°C to +85°C
- Output Voltage: 190mA 4.5V(Typ.)  
150mA 5.0V(Typ.)

### ●Package W(Typ.) x D(Typ.) x H(Max.)

VSON010V3030 3.00mm x 3.00mm x 1.00mm



**VSON010V3030**  
3.00mm x 3.00mm x 1.00mm

### ●Applications

This driver is applicable for various fields such as mobile phones, portable game machines and appliances.  
5V supply for HDMI  
5V supply for USB OTG

### ●Typical Application Circuit

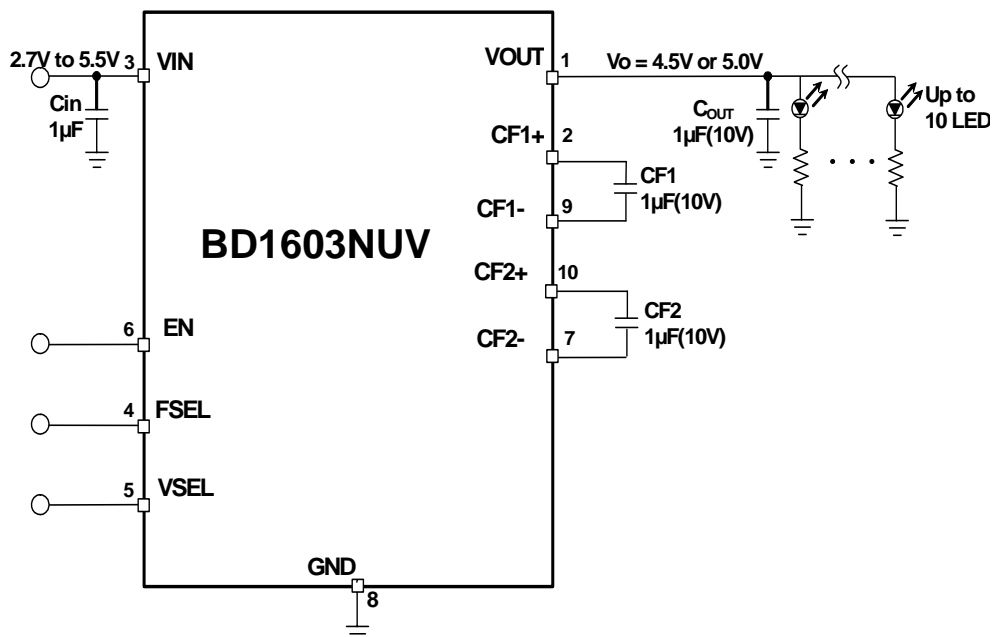

**● Absolute Maximum Ratings (Ta=25°C)**

Parameter	Symbol	Ratings	Unit	Condition
Terminal input voltage	VINMAX	7	V	
Terminal output voltage	VOMAX	7	V	
Operating temperature range	Topr	-30 to +85	°C	
Storage temperature range	Tstg	-55 to +150	°C	
Allowable loss	Pd	700(*1)	mW	

(\*1) When a glass epoxy substrate (70mm x 70mm x 1.6mm) has been mounted, this loss will decrease 5.6mW/°C if Ta is higher than or equal to 25°C.

**● Recommended Operating Rating (Ta=-30°C to +85°C)**

Parameter	Symbol	Ratings	Unit	Condition
Operating supply voltage	Vin	2.7 to 5.5	V	

**● Electrical Characteristics** ○ Unless otherwise specified, Ta = 25°C and Vin = 3.6V.

Parameter	Symbol	Limits			Unit	Condition
		Min.	Typ.	Max.		
Circuit current	I <sub>Q1</sub>	-	1.4	2.0	mA	Freq=238kHz, I <sub>OUT</sub> =0mA,
	I <sub>Q2</sub>	-	3.0	4.2	mA	Freq=642kHz, I <sub>OUT</sub> =0mA
	I <sub>Q3</sub>	-	-	2	μA	EN=0V
Output voltage	V <sub>OUT1</sub>	4.80	5.0	5.20	V	VSEL=V <sub>IN</sub> , I <sub>OUT</sub> =150mA
	V <sub>OUT2</sub>	4.275	4.5	4.725	V	VSEL=0V, I <sub>OUT</sub> =190mA
Output current	I <sub>OUT1</sub>	-	-	150	mA	VSEL=V <sub>IN</sub> 3.2V ≤ V <sub>IN</sub> *1)
	I <sub>OUT2</sub>	-	-	190	mA	VSEL=0V 3.2V ≤ V <sub>IN</sub> *1)
	I <sub>OUT3</sub>	-	-	60	mA	VSEL=V <sub>IN</sub> 2.85V ≤ V <sub>IN</sub> *1)
	I <sub>OUT4</sub>	-	-	120	mA	VSEL=0V 2.85V ≤ V <sub>IN</sub> *1)
Oscillation frequency	f <sub>OSC1</sub>	202	238	273	kHz	EN=V <sub>IN</sub> , FSEL=0V
	f <sub>OSC2</sub>	513	642	770	kHz	EN=V <sub>IN</sub> , FSEL=V <sub>IN</sub>
Output short-circuit current	I <sub>SC</sub>	-	-	600	mA	V <sub>OUT</sub> =0V
Efficiency	n <sub>1</sub>	-	75.0	-	%	V <sub>IN</sub> =3.3V, V <sub>OUT</sub> =5.0V I <sub>OUT</sub> =60mA, Freq=238kHz
	n <sub>2</sub>	-	74.5	-	%	V <sub>IN</sub> =3.3V, V <sub>OUT</sub> =5.0V I <sub>OUT</sub> =60mA, Freq=642kHz
[ Logic controller ]						
High threshold voltage	V <sub>IH</sub>	1.3	-	-	V	EN, VSEL and FSEL pins
Low threshold voltage	V <sub>IL</sub>	-	-	0.4	V	EN, VSEL and FSEL pins
'H' level input current	I <sub>IH</sub>	-	-	10	μA	EN, VSEL and FSEL pins
'L' level input current	I <sub>IL</sub>	-	-	10	μA	EN, VSEL and FSEL pins

\*1) Please design a VIN condition and a load current not to exceed Pd of the LSI.

●Pin Descriptions

Pin number	Pin name	In/Out	Function
1	VOUT	Out	Output pin
2	CF1+	In/Out	Connection pin for flying capacitor 1
3	VIN	In	Input voltage
4	FSEL	In	Frequency switch pin(L : 238kHz, H : 642kHz)
5	VSEL	In	Output voltage switch pin(L : 4.5V, H : 5.0V)
6	EN	In	ON/OFF control pin
7	CF2-	In/Out	Connection pin for flying capacitor 2
8	GND	-	Ground pin
9	CF1-	In/Out	Connection pin for flying capacitor 1
10	CF2+	In/Out	Connection pin for flying capacitor 2
-	Thermal PAD	-	Heat radiation PAD of back side Connect to GND

●Block Diagram

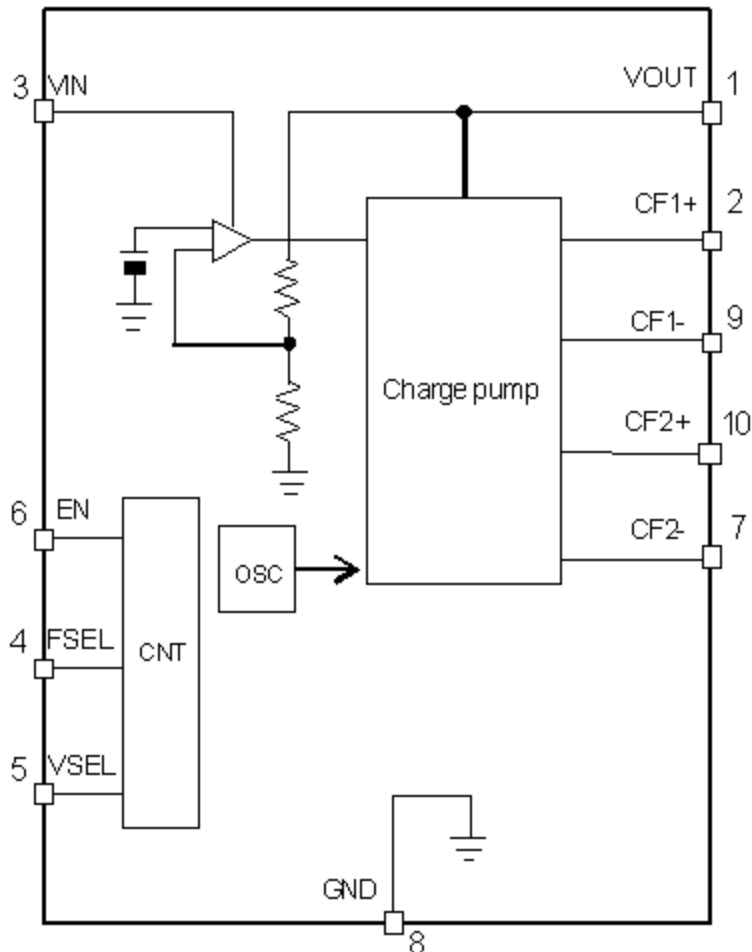

Figure 1. Block Diagram

● Typical Performance Curves

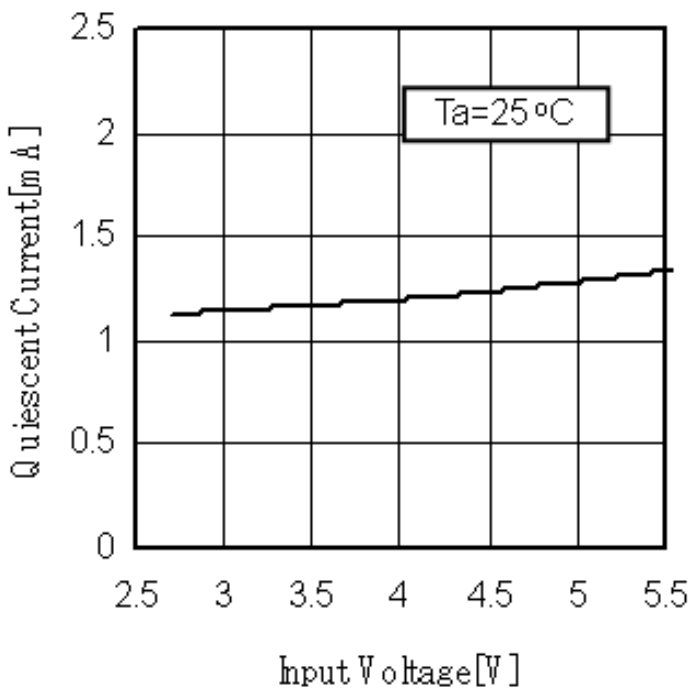

Figure 2. Quiescent Current1

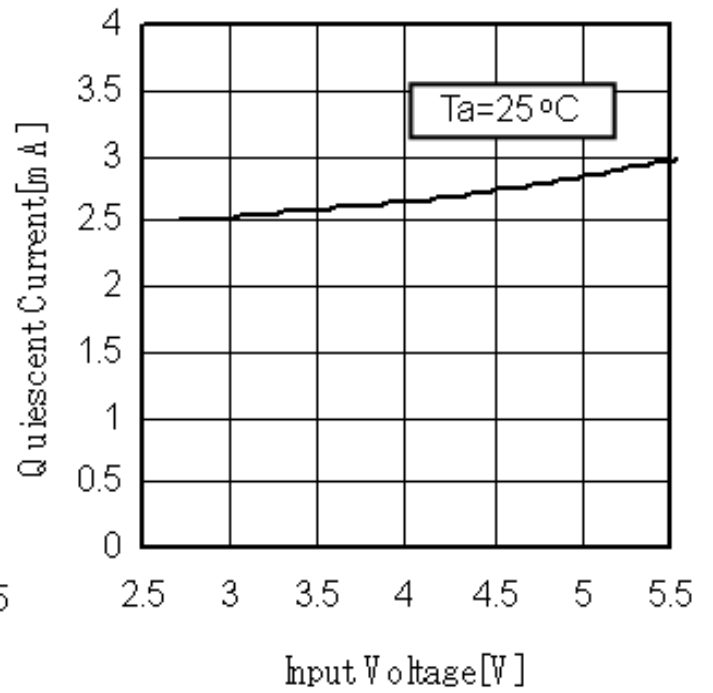

Figure 3. Quiescent Current2

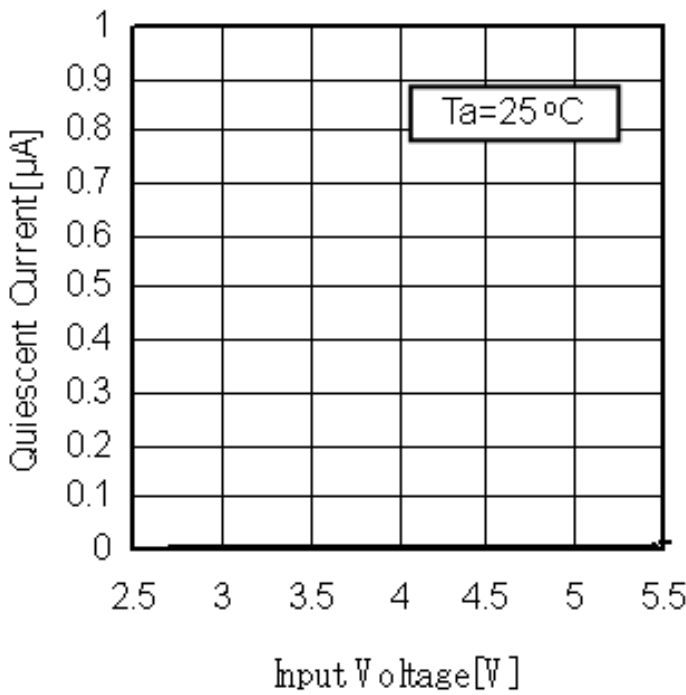

Figure 4. Quiescent Current3

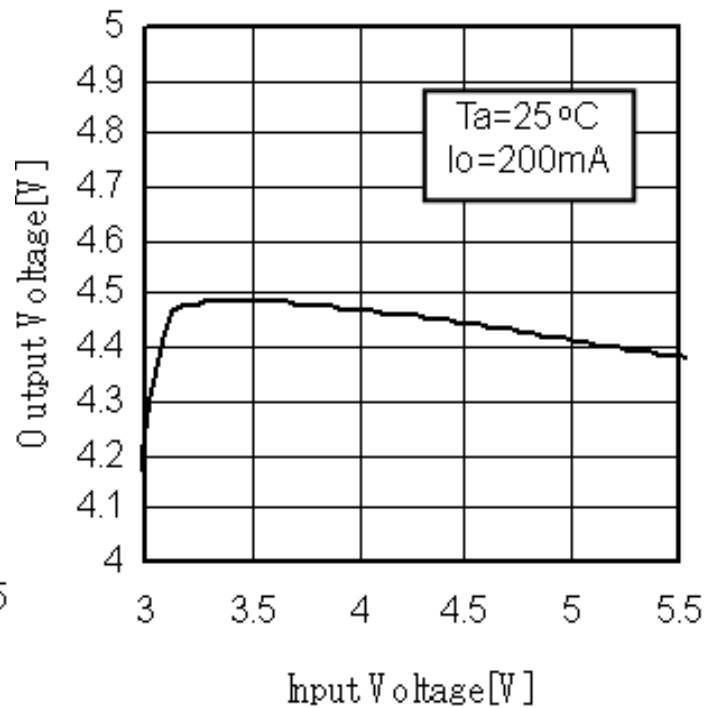

Figure 5. Line Regulation (VSEL = 0V)

● Typical Performance Curves - continued

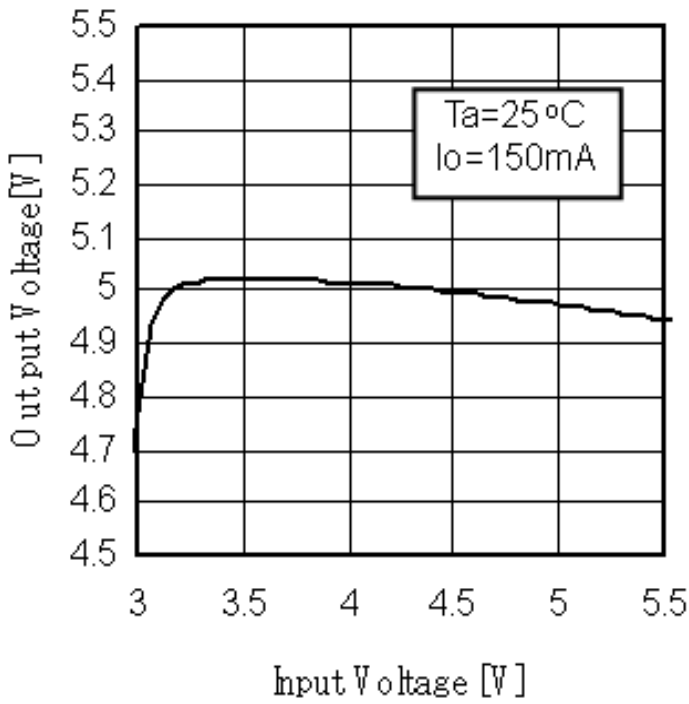

Figure 6. Line Regulation ( $V_{SEL} = V_{IN}$ )

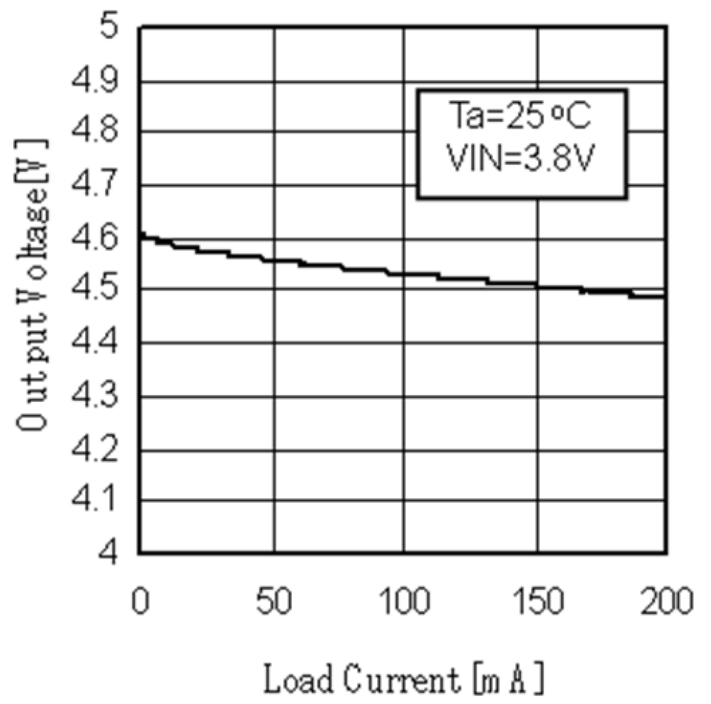

Figure 7. Load Regulation ( $V_{SEL} = 0\text{V}$ )

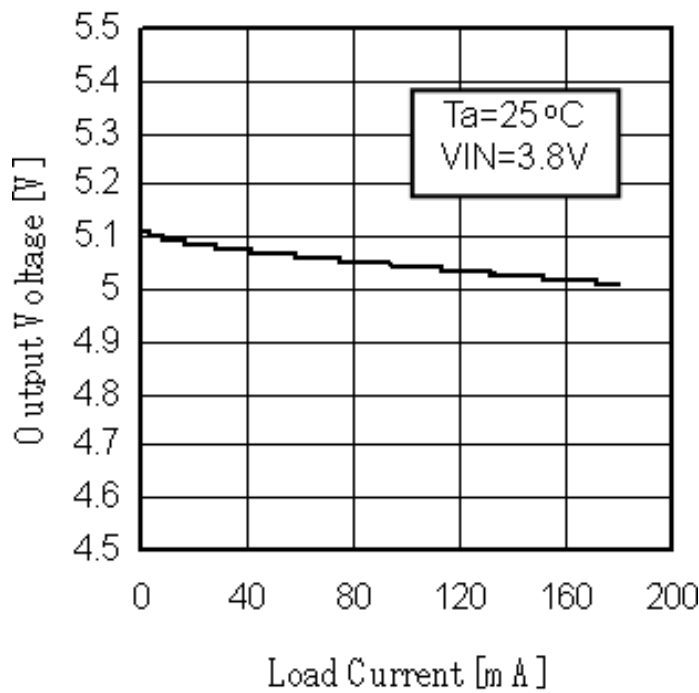

Figure 8. Load Regulation ( $V_{SEL} = V_{IN}$ )

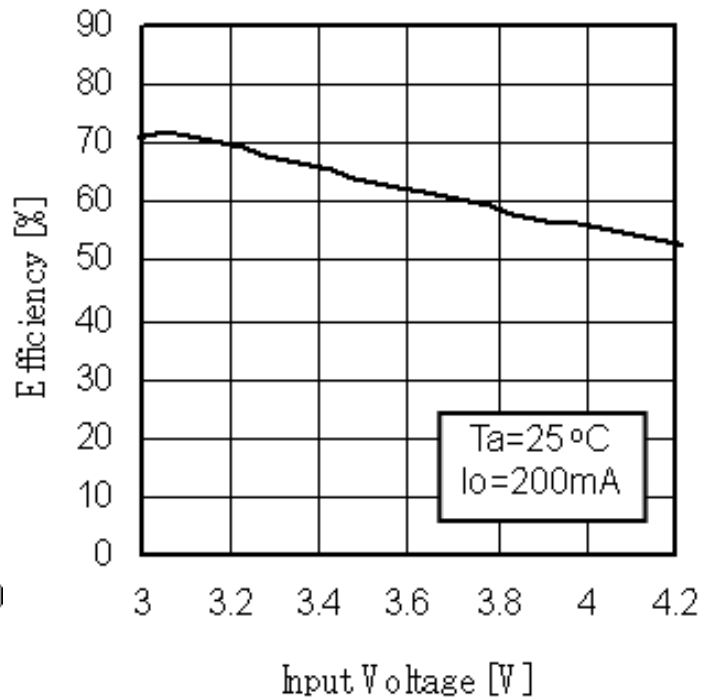

Figure 9. Efficiency vs. Input Voltage ( $V_{SEL} = 0\text{V}$ )

● Typical Performance Curves - continued

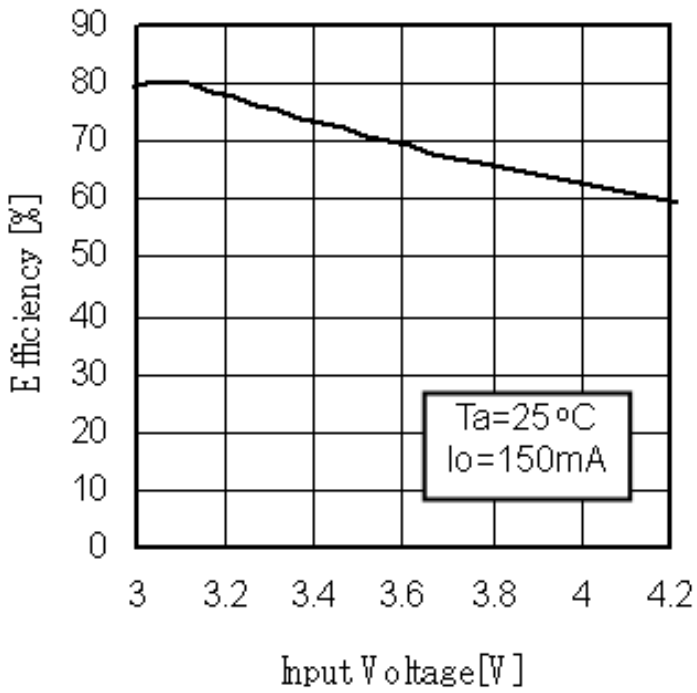

Figure 10. Efficiency vs. Input Voltage  
(VSEL = V<sub>IN</sub>)

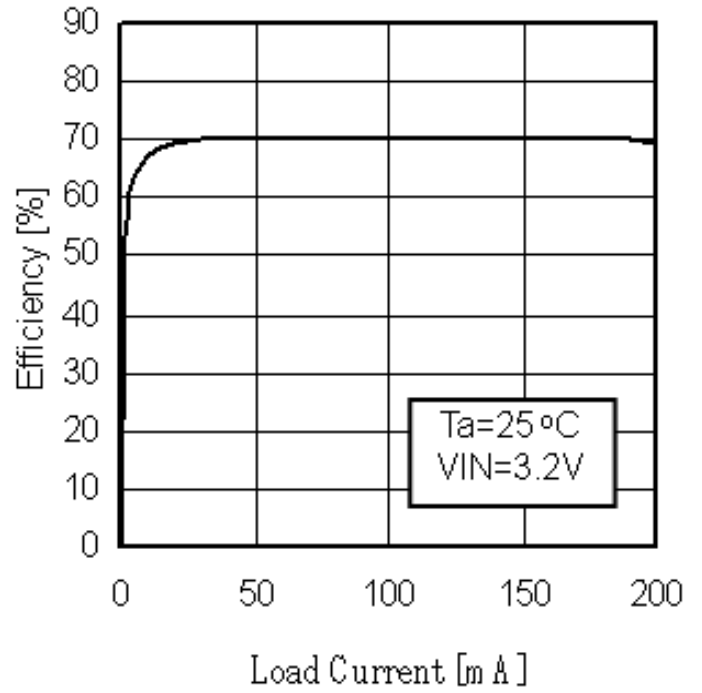

Figure 11. Efficiency vs. Load Current  
(VSEL = 0V)

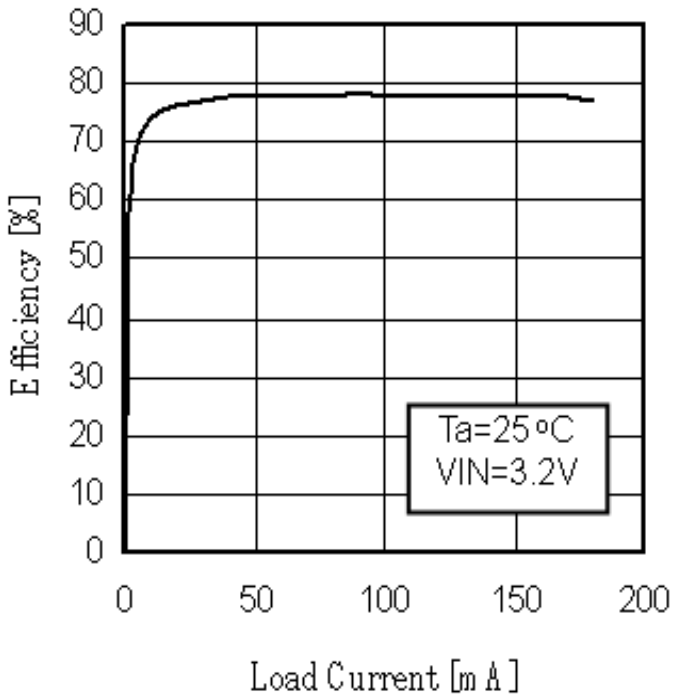

Figure 12. Efficiency vs. Load Current  
(VSEL = V<sub>IN</sub>)

## ●Description of Operations

1. ON/OFF Control  
ON/OFF control takes place via the external EN pin.  
EN = "H" : Operation  
EN = "L" : Standby
2. Low Ripple Charge Pump  
BD1603NUV is equipped with a complementary charge pump circuit that achieves low ripple output. Because BD1603NUV uses two pairs of charge switch and pump switch alternately, it can significantly reduce the output ripple in comparison with the conventional double charge pumps.
3. Frequency Select  
The operating frequency of a charge pump can be changed via the FSEL pin that is set to H or L. This operating frequency must be selected considering the influence on other devices and according to the allowable amount of ripple.

4. Efficiency  
The efficiency can be obtained from the following formula:

$$\eta = \frac{V_{OUT} \times I_O}{V_{IN} \times I_{IN}} \times 100[\%]$$

$V_{OUT}$  : Output voltage

$I_O$  : Load current

$V_{IN}$  : Input voltage

$I_{IN}$  : Input current

5. Power Consumption  
The power consumption can be obtained from the following formula:

$$P_D = P_{IN} - P_{OUT} \\ = (V_{IN} \times I_{IN}) - (V_O \times I_O) [w]$$

$V_{IN}$  and  $I_O$  must be set within an allowable loss of this LSI.

(You must set  $I_O$ [mA] that it doesn't exceed  $P_d$  of this LSI.)

Because the allowable loss greatly depends on the PCB layout, the PCB layout must be designed considering heat dissipation. In this PCB layout, the land pattern at the rear of this LSI must be directly connected to the ground plane.

6. Output Short-Circuit Current  
When the output is short-circuited to the ground, outflow current is limited for LSI protection. Once short-circuit is cleared, normal LSI operation is resumed (automatic return).
7. Thermal Shutdown  
When the chip setting temperature is 185°C (typ) or more, the thermal shutdown function is activated to turn off the charge pump circuit. When this temperature falls below to the thermal detection temperature, normal LSI operation is resumed. Accordingly, the following ON and OFF operations are repeated as thermal operations unless the primary cause is resolved.

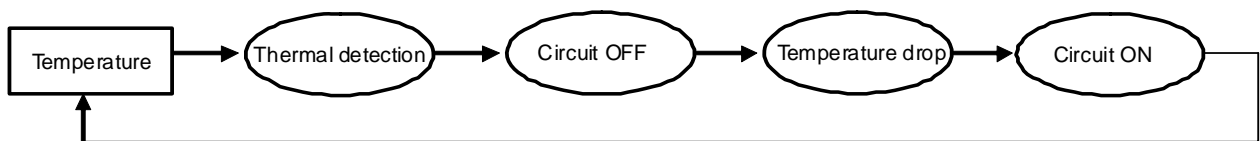

Figure 13. Thermal Detection Loop

8. Setting the LED Current

The LED current is set as follows.

The constant must be determined, considering variations in resistance and LED.

$$I_{LED} = \frac{V_{OUT} - V_F}{R} [A]$$

$V_{OUT}$ : Output voltage of BD1603NUV

$V_F$  :  $V_F$  in the LED to be connected

$R$  : LED current setting resistance

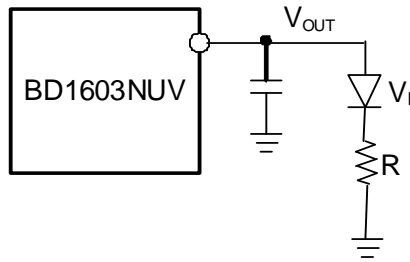

Figure 14. Setting the LED Current

9. Brightness Control

Brightness Control takes place in this LSI as follows.

a) PWM

The EN pin is turned ON or OFF repeatedly via the PWM signal.

It is recommended that the PWM frequency is 100Hz or below. This frequency must be determined, fully evaluating the linearity of brightness to the PWM duty. Brightness control must take place as shown in "b" below if the rush current causes a problem when the EN pin is ON.

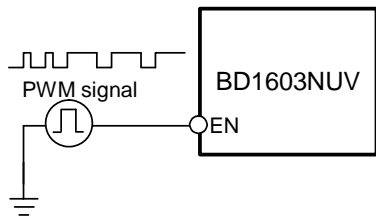

Figure 15. PWM Brightness Control

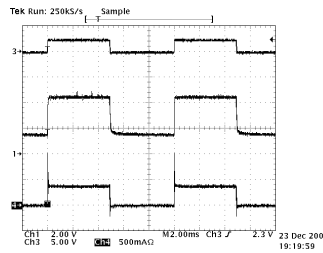

Figure 16. ON/OFF Pin Control  
(4.5V, 100Hz)

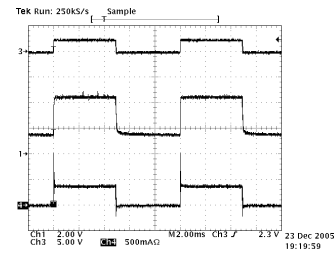

Figure 17. ON/OFF Pin Control  
(5.0V, 100Hz)

b) Switching the LED Current

Switching the LED current takes place via the external switch.

The constant must be determined, considering the ON resistance of the switch transistor.

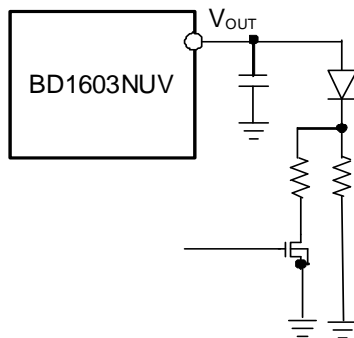

Figure 18. Brightness Control via the External Transistor



## 10. Cautions on PCB Design

BD1603NUV is equipped with a double charge pump. As the load current becomes larger, the input current also becomes larger.

- Wire a substrate in a way that the wiring impedance can be minimized. Special care should be taken for the input voltage, ground, output and flying capacitor connection pin.
- Wire the ground of an output capacitor ( $C_{OUT}$ ) near the GND pin of this LSI.
- Position a bypass capacitor to be inserted between  $V_{IN}$  (input voltage) and GND near this LSI and wire it near the  $V_{IN}$  and GND pins of this LSI.
- Heat radiation is controlled by the wiring status to the back metal. Connect it with GND plane as much as possible by a wide area.
- About the FSEL terminal and the VSEL terminal, process fixed logic by the PCB pattern when using it by fixed logic.

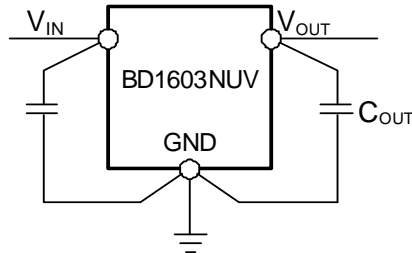
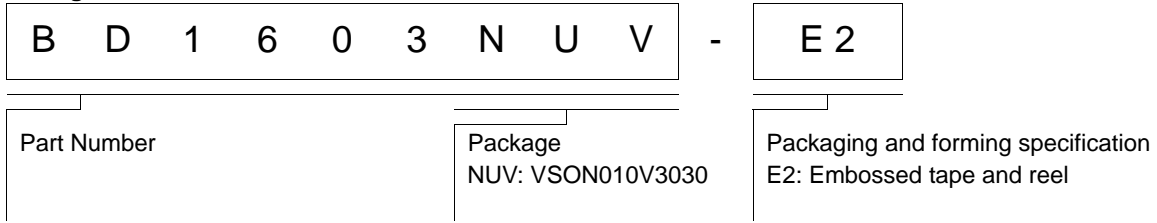

Figure 19. How to Ground in PCB Design

**●Operational Notes**

- (1) Absolute Maximum Ratings  
An excess in the absolute maximum ratings, such as supply voltage, temperature range of operating conditions, etc., can break down devices, thus making impossible to identify breaking mode such as a short circuit or an open circuit. If any special mode exceeding the absolute maximum ratings is assumed, consideration should be given to take physical safety measures including the use of fuses, etc.
- (2) Operating Conditions  
These conditions represent a range within which characteristics can be provided approximately as expected. The electrical characteristics are guaranteed under the conditions of each parameter.
- (3) Reverse Connection of Power Supply Connector  
The reverse connection of power supply connector can break down ICs. Take protective measures against the breakdown due to the reverse connection, such as mounting an external diode between the power supply and the IC's power supply terminal.
- (4) Power Supply Line  
Design PCB pattern to provide low impedance for the wiring between the power supply and the GND lines. Furthermore, for all power supply terminals to ICs, mount a capacitor between the power supply and the GND terminal. At the same time, in order to use an electrolytic capacitor, thoroughly check to be sure the characteristics of the capacitor to be used present no problem including the occurrence of capacity dropout at a low temperature, thus determining the constant.
- (5) GND Voltage  
Make setting of the potential of the GND terminal so that it will be maintained at the minimum in any operating state. Furthermore, check to be sure no terminals are at a potential lower than the GND voltage including an actual electric transient.
- (6) Short Circuit between Terminals and Erroneous Mounting  
In order to mount ICs on a set PCB, pay thorough attention to the direction and offset of the ICs. Erroneous mounting can break down the ICs. Furthermore, if a short circuit occurs due to foreign matters entering between terminals or between the terminal and the power supply or the GND terminal, the ICs can break down.
- (7) Operation in Strong Electromagnetic Field  
Be noted that using ICs in the strong electromagnetic field can malfunction them.
- (8) Inspection with Set PCB  
On the inspection with the set PCB, if a capacitor is connected to a low-impedance IC terminal, the IC can suffer stress. Therefore, be sure to discharge from the set PCB by each process. Furthermore, in order to mount or dismount the set PCB to/from the jig for the inspection process, be sure to turn OFF the power supply and then mount the set PCB to the jig. After the completion of the inspection, be sure to turn OFF the power supply and then dismount it from the jig. In addition, for protection against static electricity, establish a ground for the assembly process and pay thorough attention to the transportation and the storage of the set PCB.
- (9) Input Terminals  
In terms of the construction of IC, parasitic elements are inevitably formed in relation to potential. The operation of the parasitic element can cause interference with circuit operation, thus resulting in a malfunction and then breakdown of the input terminal. Therefore, pay thorough attention not to handle the input terminals, such as to apply to the input terminals a voltage lower than the GND respectively, so that any parasitic element will operate. Furthermore, do not apply a voltage to the input terminals when no power supply voltage is applied to the IC. In addition, even if the power supply voltage is applied, apply to the input terminals a voltage lower than the power supply voltage or within the guaranteed value of electrical characteristics.
- (10) Ground Wiring Pattern  
In terms of GND wiring, the recommended wiring is to make single-point grounding at a reference point on the set PCB. As for GND of external parts as well, please hold PCB design so that impedance may lower fully.
- (11) External Capacitor  
In order to use a ceramic capacitor as the external capacitor, determine the constant with consideration given to a degradation in the nominal capacitance due to DC bias and changes in the capacitance due to temperature, etc.
- (12) Thermal Shutdown Circuit (TSD)  
When a junction temperature rises above the setting value, the thermal shutdown circuit is activated to turn off the switch. The purpose of the thermal shutdown circuit is to block LSI when an uncontrolled operation takes place for a temperature above the setting value. The thermal shutdown circuit has not been engineered to protect or assure LSI. For this reason, don't use this circuit to enable continuous use or operation of LSI.
- (13) Thermal Design  
Thermal design must have enough margins, considering an allowable loss (Pd) in actual usage.
- (14) About the Rush Current  
For ICs with more than one power supply, it is possible that rush current may flow instantaneously due to the internal powering sequence and delays. Therefore, give special consideration to power coupling capacitance, power wiring, width of ground wiring, and routing of wiring.

●Ordering Information



●Marking Diagram

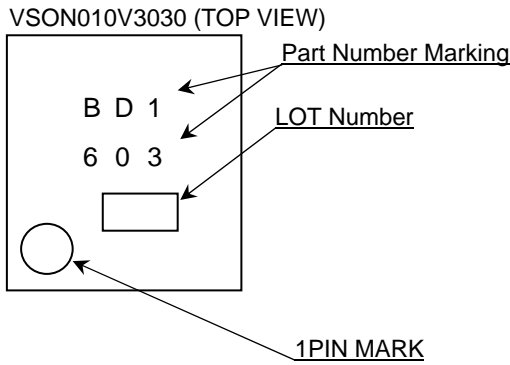

●Physical Dimension Tape and Reel Information

VSON010V3030

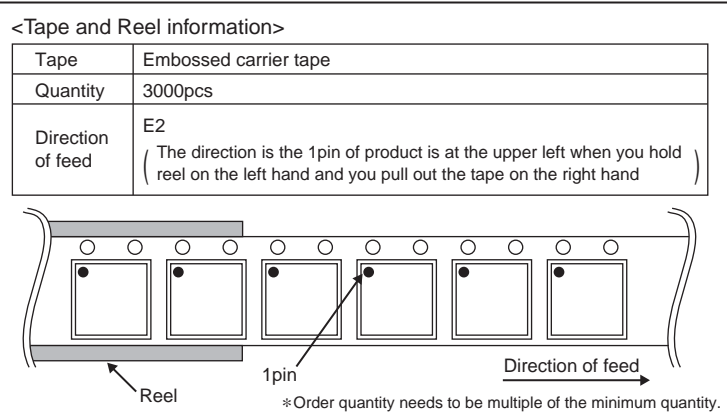
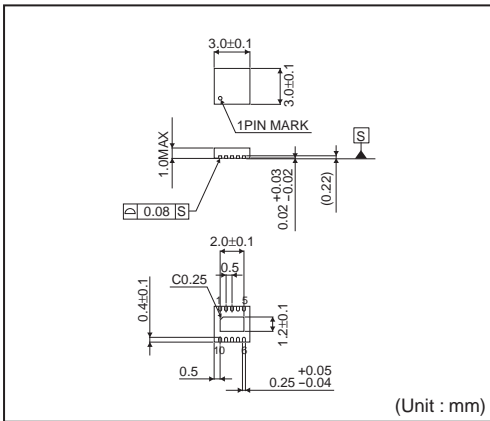

## ●Revision History

Date	Revision	Changes
17.Dec.2012	001	New Release

# Notice

## ●General Precaution

- 1) Before you use our Products, you are requested to carefully read this document and fully understand its contents. ROHM shall not be in any way responsible or liable for failure, malfunction or accident arising from the use of any ROHM's Products against warning, caution or note contained in this document.
- 2) All information contained in this document is current as of the issuing date and subject to change without any prior notice. Before purchasing or using ROHM's Products, please confirm the latest information with a ROHM sales representative.

## ●Precaution on using ROHM Products

- 1) Our Products are designed and manufactured for application in ordinary electronic equipments (such as AV equipment, OA equipment, telecommunication equipment, home electronic appliances, amusement equipment, etc.). If you intend to use our Products in devices requiring extremely high reliability (such as medical equipment, transport equipment, traffic equipment, aircraft/spacecraft, nuclear power controllers, fuel controllers, car equipment including car accessories, safety devices, etc.) and whose malfunction or failure may cause loss of human life, bodily injury or serious damage to property ("Specific Applications"), please consult with the ROHM sales representative in advance. Unless otherwise agreed in writing by ROHM in advance, ROHM shall not be in any way responsible or liable for any damages, expenses or losses incurred by you or third parties arising from the use of any ROHM's Products for Specific Applications.
- 2) ROHM designs and manufactures its Products subject to strict quality control system. However, semiconductor products can fail or malfunction at a certain rate. Please be sure to implement, at your own responsibilities, adequate safety measures including but not limited to fail-safe design against the physical injury, damage to any property, which a failure or malfunction of our Products may cause. The following are examples of safety measures:
  - [a] Installation of protection circuits or other protective devices to improve system safety
  - [b] Installation of redundant circuits to reduce the impact of single or multiple circuit failure
- 3) Our Products are designed and manufactured for use under standard conditions and not under any special or extraordinary environments or conditions, as exemplified below. Accordingly, ROHM shall not be in any way responsible or liable for any damages, expenses or losses arising from the use of any ROHM's Products under any special or extraordinary environments or conditions. If you intend to use our Products under any special or extraordinary environments or conditions (as exemplified below), your independent verification and confirmation of product performance, reliability, etc. prior to use, must be necessary:
  - [a] Use of our Products in any types of liquid, including water, oils, chemicals, and organic solvents
  - [b] Use of our Products outdoors or in places where the Products are exposed to direct sunlight or dust
  - [c] Use of our Products in places where the Products are exposed to sea wind or corrosive gases, including Cl<sub>2</sub>, H<sub>2</sub>S, NH<sub>3</sub>, SO<sub>2</sub>, and NO<sub>2</sub>
  - [d] Use of our Products in places where the Products are exposed to static electricity or electromagnetic waves
  - [e] Use of our Products in proximity to heat-producing components, plastic cords, or other flammable items
  - [f] Sealing or coating our Products with resin or other coating materials
  - [g] Use of our Products without cleaning residue of flux (even if you use no-clean type fluxes, cleaning residue of flux is recommended); or Washing our Products by using water or water-soluble cleaning agents for cleaning residue after soldering
  - [h] Use of the Products in places subject to dew condensation
- 4) The Products are not subject to radiation-proof design.
- 5) Please verify and confirm characteristics of the final or mounted products in using the Products.
- 6) In particular, if a transient load (a large amount of load applied in a short period of time, such as pulse) is applied, confirmation of performance characteristics after on-board mounting is strongly recommended. Avoid applying power exceeding normal rated power; exceeding the power rating under steady-state loading condition may negatively affect product performance and reliability.
- 7) De-rate Power Dissipation (Pd) depending on Ambient temperature (Ta). When used in sealed area, confirm the actual ambient temperature.
- 8) Confirm that operation temperature is within the specified range described in the product specification.
- 9) ROHM shall not be in any way responsible or liable for failure induced under deviant condition from what is defined in this document.

**●Precaution for Mounting / Circuit board design**

- 1) When a highly active halogenous (chlorine, bromine, etc.) flux is used, the residue of flux may negatively affect product performance and reliability.
- 2) In principle, the reflow soldering method must be used; if flow soldering method is preferred, please consult with the ROHM representative in advance.

For details, please refer to ROHM Mounting specification

**●Precautions Regarding Application Examples and External Circuits**

- 1) If change is made to the constant of an external circuit, please allow a sufficient margin considering variations of the characteristics of the Products and external components, including transient characteristics, as well as static characteristics.
- 2) You agree that application notes, reference designs, and associated data and information contained in this document are presented only as guidance for Products use. Therefore, in case you use such information, you are solely responsible for it and you must exercise your own independent verification and judgment in the use of such information contained in this document. ROHM shall not be in any way responsible or liable for any damages, expenses or losses incurred by you or third parties arising from the use of such information.

**●Precaution for Electrostatic**

This Product is electrostatic sensitive product, which may be damaged due to electrostatic discharge. Please take proper caution in your manufacturing process and storage so that voltage exceeding the Products maximum rating will not be applied to Products. Please take special care under dry condition (e.g. Grounding of human body / equipment / solder iron, isolation from charged objects, setting of Ionizer, friction prevention and temperature / humidity control).

**●Precaution for Storage / Transportation**

- 1) Product performance and soldered connections may deteriorate if the Products are stored in the places where:
  - [a] the Products are exposed to sea winds or corrosive gases, including Cl<sub>2</sub>, H<sub>2</sub>S, NH<sub>3</sub>, SO<sub>2</sub>, and NO<sub>2</sub>
  - [b] the temperature or humidity exceeds those recommended by ROHM
  - [c] the Products are exposed to direct sunshine or condensation
  - [d] the Products are exposed to high Electrostatic
- 2) Even under ROHM recommended storage condition, solderability of products out of recommended storage time period may be degraded. It is strongly recommended to confirm solderability before using Products of which storage time is exceeding the recommended storage time period.
- 3) Store / transport cartons in the correct direction, which is indicated on a carton with a symbol. Otherwise bent leads may occur due to excessive stress applied when dropping of a carton.
- 4) Use Products within the specified time after opening a humidity barrier bag. Baking is required before using Products of which storage time is exceeding the recommended storage time period.

**●Precaution for Product Label**

QR code printed on ROHM Products label is for ROHM's internal use only.

**●Precaution for Disposition**

When disposing Products please dispose them properly using an authorized industry waste company.

**●Precaution for Foreign Exchange and Foreign Trade act**

Since our Products might fall under controlled goods prescribed by the applicable foreign exchange and foreign trade act, please consult with ROHM representative in case of export.

**●Precaution Regarding Intellectual Property Rights**

- 1) All information and data including but not limited to application example contained in this document is for reference only. ROHM does not warrant that foregoing information or data will not infringe any intellectual property rights or any other rights of any third party regarding such information or data. ROHM shall not be in any way responsible or liable for infringement of any intellectual property rights or other damages arising from use of such information or data.:
- 2) No license, expressly or implied, is granted hereby under any intellectual property rights or other rights of ROHM or any third parties with respect to the information contained in this document.

● **Other Precaution**

- 1) The information contained in this document is provided on an "as is" basis and ROHM does not warrant that all information contained in this document is accurate and/or error-free. ROHM shall not be in any way responsible or liable for any damages, expenses or losses incurred by you or third parties resulting from inaccuracy or errors of or concerning such information.
- 2) This document may not be reprinted or reproduced, in whole or in part, without prior written consent of ROHM.
- 3) The Products may not be disassembled, converted, modified, reproduced or otherwise changed without prior written consent of ROHM.
- 4) In no event shall you use in any way whatsoever the Products and the related technical information contained in the Products or this document for any military purposes, including but not limited to, the development of mass-destruction weapons.
- 5) The proper names of companies or products described in this document are trademarks or registered trademarks of ROHM, its affiliated companies or third parties.

Компания «Океан Электроники» предлагает заключение долгосрочных отношений при поставках импортных электронных компонентов на взаимовыгодных условиях!

Наши преимущества:

- Поставка оригинальных импортных электронных компонентов напрямую с производств Америки, Европы и Азии, а так же с крупнейших складов мира;
- Широкая линейка поставок активных и пассивных импортных электронных компонентов (более 30 млн. наименований);
- Поставка сложных, дефицитных, либо снятых с производства позиций;
- Оперативные сроки поставки под заказ (от 5 рабочих дней);
- Экспресс доставка в любую точку России;
- Помощь Конструкторского Отдела и консультации квалифицированных инженеров;
- Техническая поддержка проекта, помощь в подборе аналогов, поставка прототипов;
- Поставка электронных компонентов под контролем ВП;
- Система менеджмента качества сертифицирована по Международному стандарту ISO 9001;
- При необходимости вся продукция военного и аэрокосмического назначения проходит испытания и сертификацию в лаборатории (по согласованию с заказчиком);
- Поставка специализированных компонентов военного и аэрокосмического уровня качества (Xilinx, Altera, Analog Devices, Intersil, Interpoint, Microsemi, Actel, Aeroflex, Peregrine, VPT, Syfer, Eurofarad, Texas Instruments, MS Kennedy, Miteq, Cobham, E2V, MA-COM, Hittite, Mini-Circuits, General Dynamics и др.);

Компания «Океан Электроники» является официальным дистрибьютором и эксклюзивным представителем в России одного из крупнейших производителей разъемов военного и аэрокосмического назначения «JONHON», а так же официальным дистрибьютором и эксклюзивным представителем в России производителя высокотехнологичных и надежных решений для передачи СВЧ сигналов «FORSTAR».



## JONHON

«JONHON» (основан в 1970 г.)

Разъемы специального, военного и аэрокосмического назначения:

(Применяются в военной, авиационной, аэрокосмической, морской, железнодорожной, горно- и нефтедобывающей отраслях промышленности)

«FORSTAR» (основан в 1998 г.)

ВЧ соединители, коаксиальные кабели,  
кабельные сборки и микроволновые компоненты:

(Применяются в телекоммуникациях гражданского и специального назначения, в средствах связи, РЛС, а так же военной, авиационной и аэрокосмической отраслях промышленности).



Телефон: 8 (812) 309-75-97 (многоканальный)

Факс: 8 (812) 320-03-32

Электронная почта: [ocean@oceanchips.ru](mailto:ocean@oceanchips.ru)

Web: <http://oceanchips.ru/>

Адрес: 198099, г. Санкт-Петербург, ул. Калинина, д. 2, корп. 4, лит. А