

LT1762/LT1962

150mA and 300mA Low Noise Micropower LDO Regulators

DESCRIPTION

Demonstration circuits DC339-A/DC339-B are low noise micropower voltage regulators using the LT[®]1762 and LT1962 in the 8-lead MSOP package. These circuits are primarily used in cellular phones, voltage-controlled

oscillators and RF power supplies, and as local regulators in larger systems. Their ability to tolerate a wide variety of output capacitors makes them ideal in space- and cost-sensitive systems.

 LTC and LT are registered trademarks of Linear Technology Corporation.

PERFORMANCE SUMMARY

$T_A = 25^\circ\text{C}$, $V_{IN} = 2.3\text{V}$, $V_{SHDN} = 5\text{V}$, $I_{LOAD} = 1\text{mA}$, $V_{OUT} = 1.22\text{V}$ (JP2 set on pins 1 and 2), unless otherwise specified.

PARAMETER	CONDITIONS	MIN	TYP	MAX	UNITS
Input Voltage Range		2.3		20	V
Output Voltage (Note 1)	$V_{IN} = 3.5\text{V}$, JP2 On Pins 5, 6 $V_{IN} = 4\text{V}$, JP2 On Pins 7, 8 $V_{IN} = 4.3\text{V}$, JP2 On Pins 9, 10 $V_{IN} = 5\text{V}$, JP2 On Pins 11, 12	1.205 2.455 2.936 3.207 4.848	1.220 2.506 3.019 3.300 5.006	1.235 2.571 3.103 3.396 5.167	V V V V V
Line Regulation	$\Delta V_{IN} = 2.3\text{V to } 20\text{V}$		1	5	mV
Quiescent Current	$I_{LOAD} = 0$		30	50	μA
Load Regulation	$\Delta I_{LOAD} = 1\text{mA to } 150\text{mA}$ (DC339-A) or 300mA (DC339-B)		0.2	1	%
SHDN Pin Threshold	On to Off Off to On, $I_{LOAD} = 150\text{mA}$ (DC339-A) or 300mA (DC339-B)	0.45	0.65	1.8	V
Output Voltage Noise	$I_{LOAD} = 150\text{mA}$ (DC339-A) or 300mA (DC339-B) BW = 10Hz to 100kHz		20		μV_{RMS}

Note 1: Output voltage variations include $\pm 1\%$ tolerance of feedback divider network. For tighter voltage range, use lower tolerance resistors or use fixed voltage output devices.

TYPICAL PERFORMANCE CHARACTERISTICS AND BOARD PHOTO

LT1762 Typical Dropout Voltage

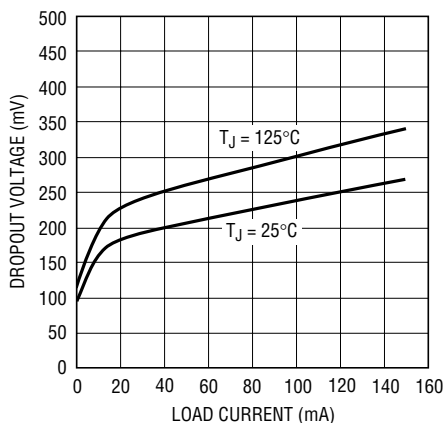

1762 G01

LT1762 (5V Output)
10Hz to 100kHz Output Noise

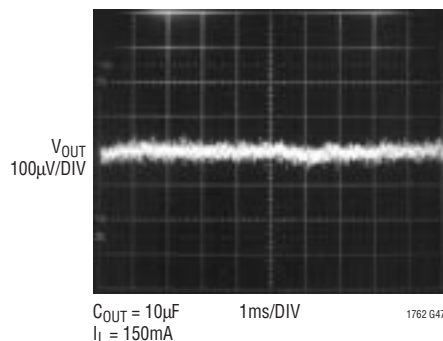

Component Side



DEMO MANUAL DC339-A/-B

LOW DROPOUT REGULATOR

TYPICAL PERFORMANCE CHARACTERISTICS AND BOARD PHOTO

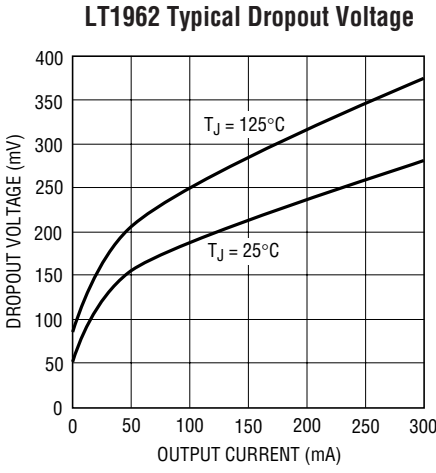

1962 G01

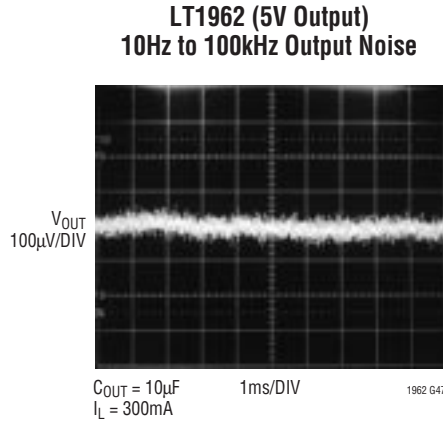

1962 G47



PACKAGE AND SCHEMATIC DIAGRAMS

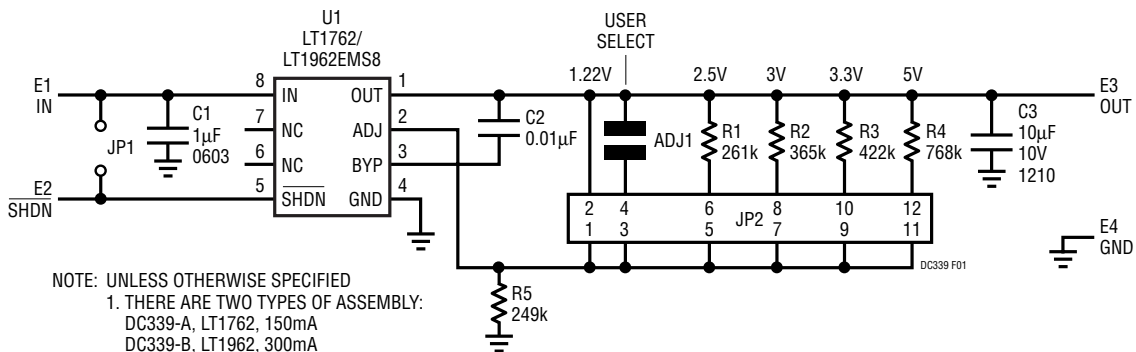
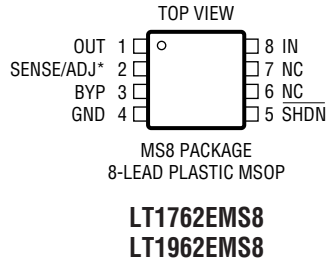

Figure 1. LT1762/LT1962 150mA/300mA Low Noise Micropower LDO Regulator

PARTS LIST

REFERENCE DESIGNATOR	QUANTITY	PART NUMBER	DESCRIPTION	VENDOR	TELEPHONE
ADJ1	0		Optional Resistor		
C1	1	0603ZG105ZAT1A	1 μ F 10V Y5V Chip Capacitor	AVX	(843) 946-0362
C2	1	0402ZG104ZAT1A	0.1 μ F 10V Y5V Chip Capacitor	AVX	(843) 946-0362
C3	1	LMK325BJ106MN	10 μ F 10V X7R Chip Capacitor	Taiyo-Yuden	(408) 573-4150
E1 to E4	4	2308-2	Pad Turret	Mill-Max	(516) 922-6000
JP1	0		Optional Jumper		
JP2	1	6351-12G1	Connector, SMT2X6, 0.39" Gap	Comm-Con	(626) 301-4200
Shunts for JP1 and JP2	2	CTAIJ1MM-G	Shunts for 0.39" Gap	Comm-Con	(626) 301-4200
R1	1	CR05-2613FM	261k 1/16W 1% Chip Resistor	AAC	(800) 508-1521
R2	1	CR05-3653FM	365k 1/16W 1% Chip Resistor	AAC	(800) 508-1521
R3	1	CR05-4223FM	422k 1/16W 1% Chip Resistor	AAC	(800) 508-1521
R4	1	CR05-7683FM	768k 1/16W 1% Chip Resistor	AAC	(714) 255-9186
R5	1	CR05-2493FM	249k 1/16W 1% Chip Resistor	AAC	(714) 255-9186
U1	1	LT1762EMS8 or LT1962EMS8	8-Lead MSOP IC Version -A 8-Lead MSOP IC Version -B	LTC	(408) 432-1900

OPERATION

HOOK-UP

Solid turret terminals are provided for easy connection to supplies and test equipment. Connect a 0V to 20V, 0.5A power supply across the IN and GND terminals and the load across the OUT and GND terminals. The SHDN pin can be disconnected from IN via JP1 to allow for separate shutdown control via a secondary control line. JP2 can be used to select any of a number of common fixed output voltages, or used in conjunction with ADJ1 to create a custom output voltage using the formula:

$$ADJ1 = (V_{OUT} - 1.22V)/4.93\mu A$$

OUTPUT CAPACITOR SELECTION

The output capacitor C3 is a 10 μ F X7R ceramic chip capacitor. Should a different output capacitor be desired, care must be exercised with the selection. Many ceramic capacitor dielectrics exhibit strong temperature and voltage characteristics that reduce their effective capacitance to as low as 10% to 20% of nominal over the full range. For further information, see Linear Technology

Application Note 83, "Performance Verification of Low Noise, Low Dropout Regulators," Appendix B, "Capacitor Selection Considerations," reprinted below.

CAPACITOR SELECTION CONSIDERATIONS

Bypass Capacitance and Low Noise Performance

Adding a capacitor between the regulator's V_{OUT} and BYP pins lowers output noise. A good quality, low leakage capacitor is recommended. This capacitor bypasses the regulator's reference, providing a low frequency noise pole. A 0.01 μ F capacitor lowers the output voltage noise to 20 μ V_{RMS}. Using a bypass capacitor also improves transient response. With no bypassing and a 10 μ F output capacitor, a 10mA to 500mA load step settles within 1% of final value in under 100 μ s. With a 0.01 μ F bypass capacitor, the output settles within 1% for the same load step in under 10 μ s; total output deviation is inside 2.5%. Regulator start-up time is inversely proportional to bypass capacitor size, slowing to 15ms with a 0.01 μ F bypass capacitor and 10 μ F at the output.

OPERATION

Output Capacitance and Transient Response

The regulators are designed to be stable with a wide range of output capacitors. Output capacitor ESR affects stability, most notably with small capacitors. A $3.3\mu\text{F}$ minimum output value with ESR of 3Ω or less is recommended to prevent oscillation. Transient response is a function of output capacitance. Larger values of output capacitance decrease peak deviations, providing improved transient response for large load current changes. Bypass capacitors, used to decouple individual components powered by the regulator, increase the effective output capacitor value. Larger values of reference bypass capacitance dictate larger output capacitors. For 100pF of bypass capacitance, $4.7\mu\text{F}$ of output capacitor is recommended. With 1000pF or more of bypass capacitance, a $6.8\mu\text{F}$ output capacitor is required.

The shaded regions of Figures B1 and B2 define the regulator's stability range. Minimum ESR needed is set by the amount of bypass capacitance used, while maximum ESR is 3Ω .

Ceramic Capacitors

Ceramic capacitors require extra consideration. They are manufactured with a variety of dielectrics, each with

different behavior across temperature and applied voltage. The most common dielectrics are Z5U, Y5V, X5R and X7R. The Z5U and Y5V dielectrics provide high capacitance in a small package, but exhibit strong voltage and temperature coefficients, as shown in Figures B3 and B4. Used with a 5V regulator, a $10\mu\text{F}$ Y5V capacitor shows values as low as $1\mu\text{F}$ to $2\mu\text{F}$ over the operating temperature range. The X5R and X7R dielectrics have more stable characteristics and are more suitable for output capacitor use. The X7R type has better stability over temperature, while the X5R is less expensive and available in higher values.

Voltage and temperature coefficients are not the only problem sources. Some ceramic capacitors have a piezoelectric response. A piezoelectric device generates voltage across its terminals due to mechanical stress, similar to the way a piezoelectric accelerometer or microphone works. For a ceramic capacitor, the stress can be induced by vibrations in the system or thermal transients. The resulting voltages can cause appreciable amounts of noise, especially when a ceramic capacitor is used for noise bypassing. A ceramic capacitor produced Figure B5's trace in response to light tapping from a pencil. Similar vibration-induced behavior can masquerade as increased output voltage noise.

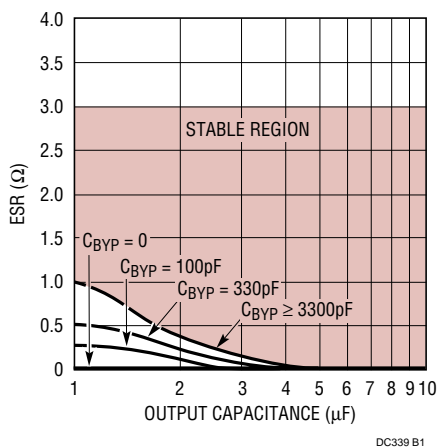

Figure B1. LT1762 Regulator Stability for Various Output and Bypass (C_{BYP}) Capacitor Characteristics

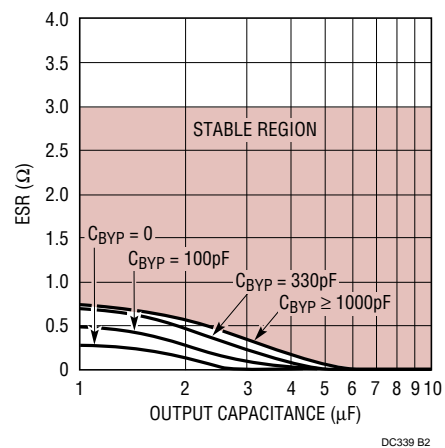
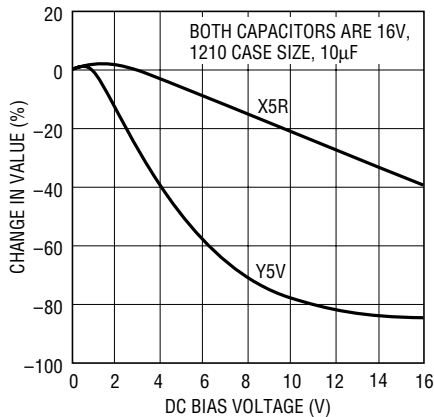

Figure B2. LT1962 Regulator Stability for Various Output and Bypass (C_{BYP}) Capacitor Characteristics

OPERATION



DC339 B3

Figure B3. Ceramic Capacitor DC Bias Characteristics Indicate Pronounced Voltage Dependence. Device Must Provide Desired Capacitance Value at Operating Voltage

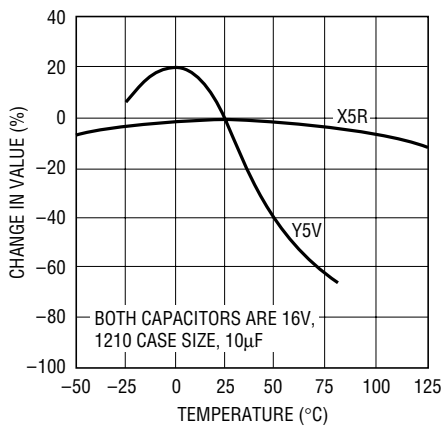

DC339 B4

Figure B4. Ceramic Capacitor Temperature Characteristics Show Large Capacitance Shift. Effect Should Be Considered When Determining Circuit Error Budget

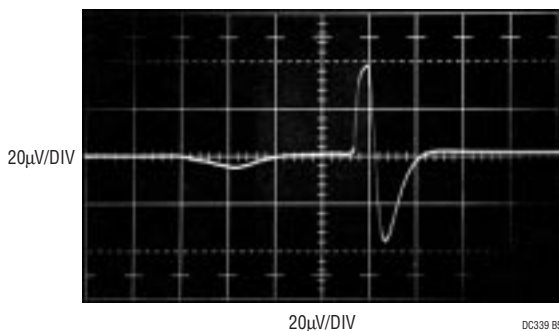

DC339 B5

Figure B5. A Ceramic Capacitor Responds to Light Pencil Tapping. Piezoelectric Based Response Approaches 80µV_{p-p}

OUTPUT VOLTAGE NOISE

Measuring output voltage noise can be a tricky process, further complicated by the low levels of noise inherent in a circuit such as this. Consideration must be given to regulator operating conditions, as well as the noise bandwidth of interest. Linear Technology has invested an enormous amount of time to provide accurate, relevant data to customers regarding noise performance. For further information on measuring output voltage noise, see Linear Technology Application Note 83, “Performance Verification of Low Noise, Low Dropout Regulators.”

Noise Testing Considerations

What noise bandwidth is of interest and why is it interesting? In most systems, the range of 10Hz to 100kHz is the information signal processing area of concern. Additionally, linear regulators produce little noise energy outside this region.¹ These considerations suggest a measurement bandpass of 10Hz to 100kHz, with steep slopes at the band limits. Figure 2 shows a conceptual filter for LDO noise testing. The Butterworth sections are the key to steep slopes and flatness in the passband. The small input level requires 60dB of low noise gain to provide adequate signal for the Butterworth filters. Figure 3 details the filter scheme. The regulator under test is at the diagram’s center.² A1–A3 make up a 60dB gain highpass section. A1 and A2, extremely low noise devices (<1nV√Hz), comprise a 60dB gain stage with a 5Hz highpass input. A3 provides a 10Hz, 2nd order Butterworth highpass characteristic. The LTC[®]1562 filter block is arranged as a 4th order Butterworth lowpass. Its output is delivered via the 330µF–100Ω highpass network. The circuit’s output drives a thermally responding RMS voltmeter.³ Note that all circuit power is furnished by batteries, precluding ground loops from corrupting the measurement.

Note 1: Switching regulators are an entirely different proposition, requiring very broadband noise measurement.

Note 2: Component choice for the regulator, more critical than might be supposed, is discussed in “Capacitor Selection Considerations.”

Note 3: The choice of the RMS voltmeter is absolutely crucial to obtaining meaningful measurements. See Appendix C, Application Note 83 “Understanding and Selecting RMS Voltmeters.”

DEMO MANUAL DC339-A/-B

LOW DROPOUT REGULATOR

OPERATION

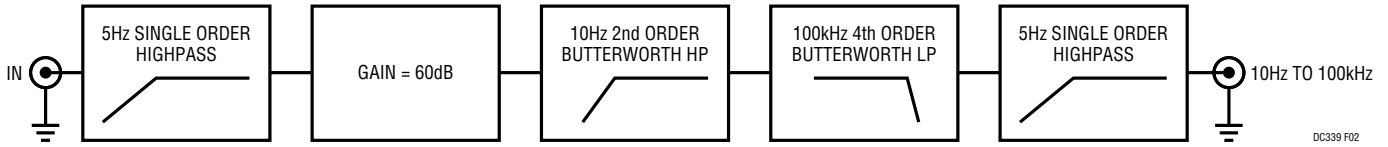
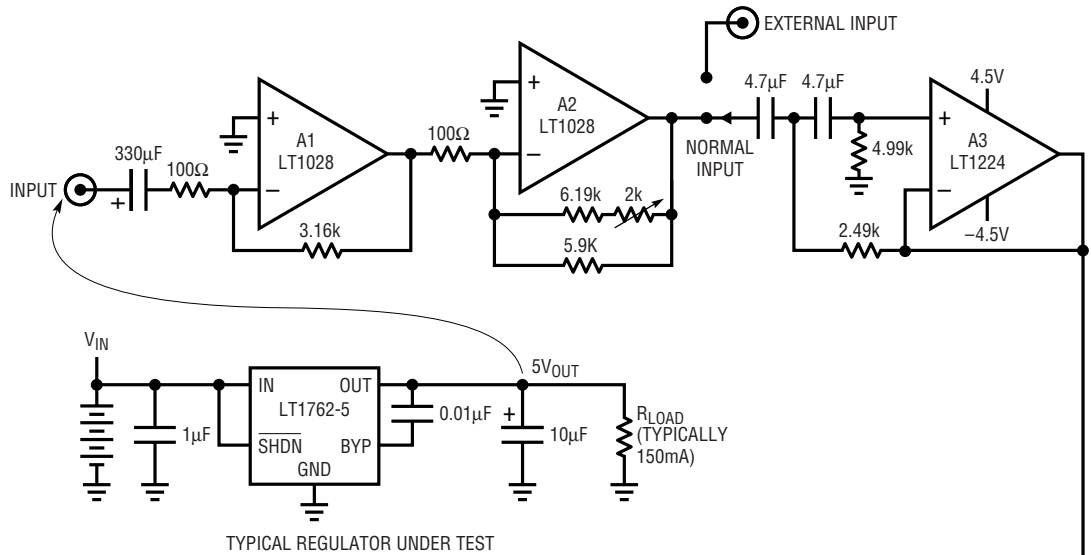

Figure 2. Filter Structure for Noise Testing LDOs. Butterworth Sections Provide Appropriate Response in Desired Frequency Range



ALL RESISTORS 1% METAL FILM
 4.7µF CAPACITORS = MYLAR, WIMA MKS-2
 330µF CAPACITORS = SANYO OSCON
 ±4.5V DERIVED FROM 6AA CELLS
 POWER REGULATOR FROM APPROPRIATE
 NUMBER OF D SIZE BATTERIES

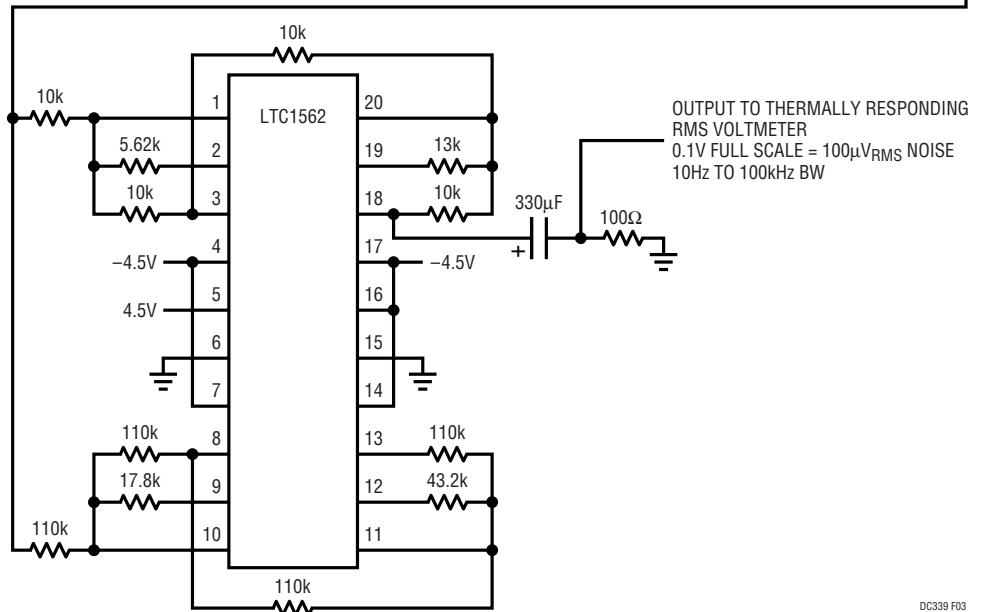
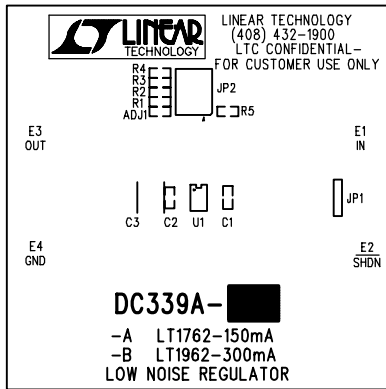
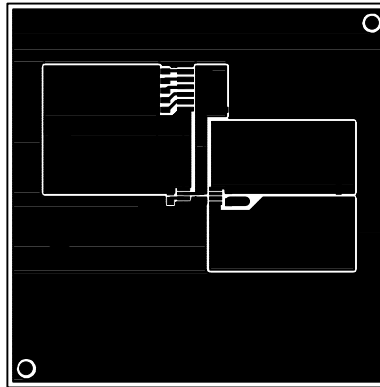

Figure 3. Implementation of Figure 2. Low Noise Amplifiers Provide Gain and Initial Highpass Shaping. LTC1562 Filter Supplies 4th Order Butterworth Lowpass Characteristic

PCB LAYOUT AND FILM



Component Side Silkscreen



Component Side

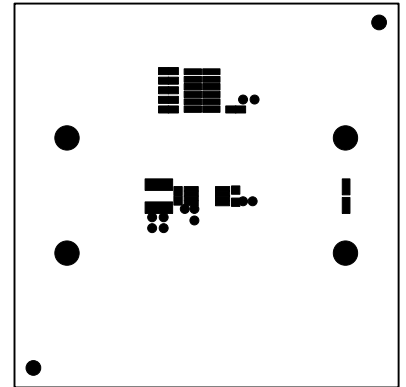

Component Side Solder Mask

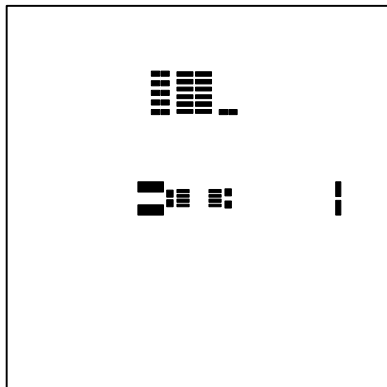

Component Side Paste Mask

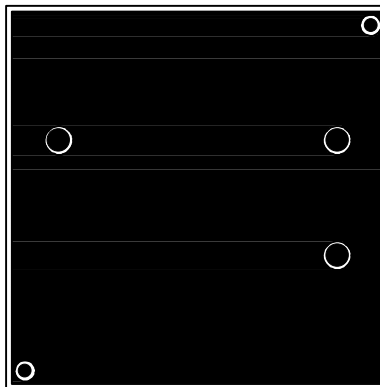

Solder Side

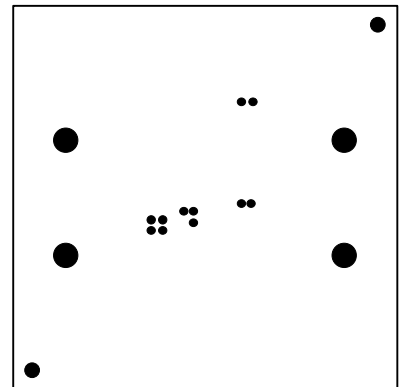

Solder Side Solder Mask

DEMO MANUAL DC339-A/-B

LOW DROPOUT REGULATOR

PC FAB DRAWING

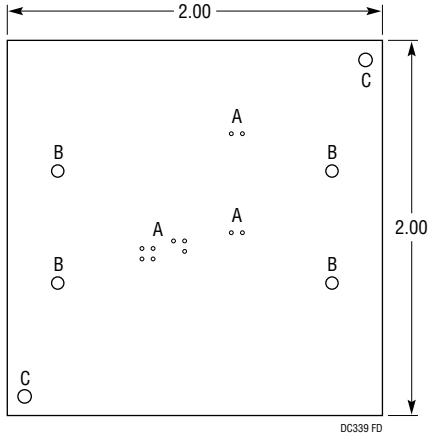

NOTES: UNLESS OTHERWISE SPECIFIED

1. MATERIAL: FR4 OR EQUIVALENT EPOXY,
2 OZ COPPER CLAD, THICKNESS 0.062 ± 0.006
TOTAL OF 2 LAYERS
2. FINISH: ALL PLATED HOLES 0.001 MIN/0.0015 MAX
COPPER PLATE, ELECTRODEPOSITED TIN-LEAD COMPOSITION
BEFORE REFLOW, SOLDER MASK OVER BARE COPPER (SMOBC)
3. SOLDER MASK: BOTH SIDES USING LPI OR EQUIVALENT
4. SILKSCREEN: USING WHITE NONCONDUCTIVE EPOXY INK
5. UNUSED SMD COMPONENTS SHOULD BE FREE OF SOLDER
6. FILL UP ALL VIAS WITH SOLDER
7. SCORING

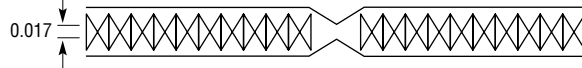

SYMBOL	DIAMETER	NUMBER OF HOLES	PLATED
A	0.020	11	PLTD
B	0.060	4	PLTD
C	0.070	2	NPLTD
	TOTAL HOLES	17	

Компания «Океан Электроники» предлагает заключение долгосрочных отношений при поставках импортных электронных компонентов на взаимовыгодных условиях!

Наши преимущества:

- Поставка оригинальных импортных электронных компонентов напрямую с производств Америки, Европы и Азии, а так же с крупнейших складов мира;
- Широкая линейка поставок активных и пассивных импортных электронных компонентов (более 30 млн. наименований);
- Поставка сложных, дефицитных, либо снятых с производства позиций;
- Оперативные сроки поставки под заказ (от 5 рабочих дней);
- Экспресс доставка в любую точку России;
- Помощь Конструкторского Отдела и консультации квалифицированных инженеров;
- Техническая поддержка проекта, помощь в подборе аналогов, поставка прототипов;
- Поставка электронных компонентов под контролем ВП;
- Система менеджмента качества сертифицирована по Международному стандарту ISO 9001;
- При необходимости вся продукция военного и аэрокосмического назначения проходит испытания и сертификацию в лаборатории (по согласованию с заказчиком);
- Поставка специализированных компонентов военного и аэрокосмического уровня качества (Xilinx, Altera, Analog Devices, Intersil, Interpoint, Microsemi, Actel, Aeroflex, Peregrine, VPT, Syfer, Eurofarad, Texas Instruments, MS Kennedy, Miteq, Cobham, E2V, MA-COM, Hittite, Mini-Circuits, General Dynamics и др.);

Компания «Океан Электроники» является официальным дистрибьютором и эксклюзивным представителем в России одного из крупнейших производителей разъемов военного и аэрокосмического назначения «JONHON», а так же официальным дистрибьютором и эксклюзивным представителем в России производителя высокотехнологичных и надежных решений для передачи СВЧ сигналов «FORSTAR».



JONHON

«JONHON» (основан в 1970 г.)

Разъемы специального, военного и аэрокосмического назначения:

(Применяются в военной, авиационной, аэрокосмической, морской, железнодорожной, горно- и нефтедобывающей отраслях промышленности)

«FORSTAR» (основан в 1998 г.)

ВЧ соединители, коаксиальные кабели,
кабельные сборки и микроволновые компоненты:

(Применяются в телекоммуникациях гражданского и специального назначения, в средствах связи, РЛС, а так же военной, авиационной и аэрокосмической отраслях промышленности).



Телефон: 8 (812) 309-75-97 (многоканальный)

Факс: 8 (812) 320-03-32

Электронная почта: ocean@oceanchips.ru

Web: <http://oceanchips.ru/>

Адрес: 198099, г. Санкт-Петербург, ул. Калинина, д. 2, корп. 4, лит. А