



## Features

- Single-turn (3851 and 3852)
- Linear and audio tapers
- 3-3/4-turn (3856)
- Wide resistance range
- Minimal depth package
- Good resolution

## 3851/3852/3856 - 3/4 " Diameter Panel Control

### Initial Electrical Characteristics<sup>1</sup>

|   | <b>3851<br/>Conductive Plastic Element</b>                  | <b>3852/3856<br/>Cermet Element</b>                          |
|---|---|--|
| Standard Resistance Range   |   |  |
| Linear Tapers (A, B, E, and H).....   | 1 K to 1 megohm.....  | 100 ohms to 1 megohm   |
| Audio Tapers (C, D, F, and G).....  | 1 K to 1 megohm.....  | 1 K ohms to 1 megohm   |
| Total Resistance Tolerance.....   | ±10 % or ±20 %.....   | ±5 % or ±10 %  |
| Independent Linearity.....  | ±10 %.....  | (A & H tapers) ±5 %  |
| Absolute Minimum Resistance.....  | 2 ohms maximum.....   | 2 ohms maximum   |
| Effective Electrical Angle.....   | 250 ° ±5 °.....   | 250 ° ±5 °   |
| Contact Resistance Variation.....   | ±1 %.....   | ±3 % of total resistance or 3 ohms<br>(whichever is greater) |
| Dielectric Withstanding Voltage (MIL-STD-202, Method 301)                         |   |  |
| Sea Level.....  | 900 VAC minimum.....  | 900 VAC minimum  |
| 70,000 Feet.....  | 350 VAC minimum.....  | 350 VAC minimum  |
| Insulation Resistance (500 VDC).....  | 1,000 megohms minimum.....                                  | 1,000 megohms minimum  |
| Power Rating (Voltage Limited By Power Dissipation or 350 VAC, Whichever Is Less) |   |  |
| +70 °C.....   | (Linear tapers) 1 watt.....<br>(Audio tapers) 0.5 watt..... | (Linear tapers) 2 watts<br>(Audio tapers) 1 watt             |
| +125 °C.....  | 0 watt.....   |  |
| +150 °C.....  | 0 watt.....   | 0 watt   |
| Theoretical Resolution.....   | Essentially infinite.....                                   | Essentially infinite   |

### Environmental Characteristics<sup>1</sup>

|  |                        |   |
|--|------------------------|---|
| Operating Temperature Range.....                           | -1 °C to +125 °C.....  | -1 °C to +125 °C                        |
| Storage Temperature Range.....                             | -65 °C to +125 °C..... | -65 °C to +150 °C                       |
| Temperature Coefficient Over                               |                        |   |
| Storage Temperature Range.....                             | ±1,000 ppm/°C.....     | ±150 ppm/°C                             |
| Vibration.....   | 20 G.....              | 20 G                                    |
| Total Resistance Shift.....                                | ±2 % maximum.....      | ±2 % maximum                            |
| Voltage Ratio Shift.....                                   | ±5 % maximum.....      | ±6 % maximum                            |
| Shock.....   | 100 G.....             | 100 G                                   |
| Total Resistance Shift.....                                | ±2 % maximum.....      | ±2 % maximum                            |
| Voltage Ratio Shift.....                                   | ±5 % maximum.....      | ±6 % maximum                            |
| Load Life.....   | 1,000 hours.....       | 1,000 hours                             |
| Total Resistance Shift.....                                | ±10 % maximum.....     | ±3 % maximum                            |
| Rotational Life (No Load).....                             | 100,000 cycles.....    | 50,000 cycles                           |
| Total Resistance Shift.....                                | ±15 % TRS maximum..... | ±5 % or 5 ohms TRS whichever is greater |
| Contact Resistance Variation.....                          | ±3 %.....              | ±3 %                                    |
| Moisture Resistance (MIL-STD-202, Method 103, Condition B) |                        |   |
| Total Resistance Shift.....                                | ±10 % maximum.....     | ±2 % maximum                            |
| IP Rating.....   | IP 40.....             | IP 40                                   |

### Mechanical Characteristics<sup>1</sup>

|  |   |
|--|---|
| Stop Strength                                  |   |
| 3851 & 3852.....                               | 56.5 N-cm (5 lb.-in.)   |
| 3856.....                                      | Continuous turn   |
| Mechanical Angle.....                          | 280 ° ±5 ° / 3856 – 1350 ° ±50 °  |
| Torque (Starting and Running).....             | A & B bushings 0.35 to 4.23 N-cm (0.05 to 6.0 oz.-in.)<br>C & E bushings 0.21 to 4.23 N-cm (0.3 to 6.0 oz.-in.)<br>3856 – 0.11 to 2.12 N-cm (0.15 to 3.0 oz.-in.)   |
| Mounting (Torque on Bushing).....              | 1.7-2.0 N-m (15-18 lb.-in.) maximum   |
| Weight (Single Section).....                   | 30 grams maximum  |
| Terminals.....                                 | Printed circuit terminals or solder lugs  |
| Soldering Condition.....                       | Recommended hand soldering using Sn95/Ag5 no clean solder, 0.025 " wire diameter.<br>Maximum temperature 399 °C (750 °F) for 3 seconds. No wash process to be used with no clean flux.<br>Part can be wave soldered at 260 °C (500 °F) for 5 seconds, no wash process with no clean flux. |
| Marking.....                                   | Manufacturer's trademark, wiring diagram, resistance, date code, and part number  |
| Ganging (Multiple Section Potentiometers)..... | 1 cup maximum   |
| Hardware.....                                  | One lockwasher and one mounting nut is shipped with each potentiometer, except where noted in the part number.  |

<sup>1</sup> At room ambient: +25 °C nominal and 50 % relative humidity nominal, except as noted.

\*RoHS Directive 2002/95/EC Jan. 27, 2003 including annex and RoHS Recast 2011/65/EU June 8, 2011.  
Specifications are subject to change without notice.  
The device characteristics and parameters in this data sheet can and do vary in different applications and actual device performance may vary over time.  
Users should verify actual device performance in their specific applications.

# 3851/3852/3856 - 3/4" Diameter Panel Control

**BOURNS®**

## Product Dimensions

### 3851A/3852A



### 3851B/3852B



## Terminal Configuration

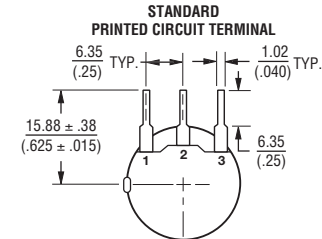

## SUGGESTED BOARD LAYOUT

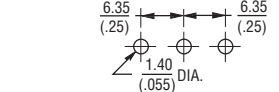

### 3851C/3852C



### 3851E/3852E

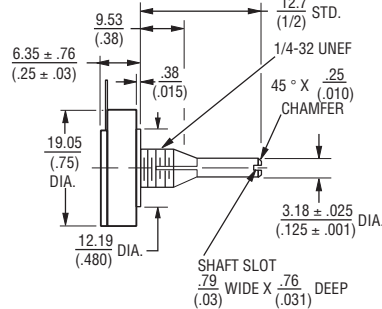

## 3851/3852/3856

### A, B & H BUSHINGS

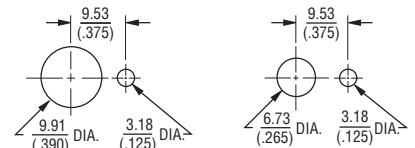

### 3856A



### 3856H

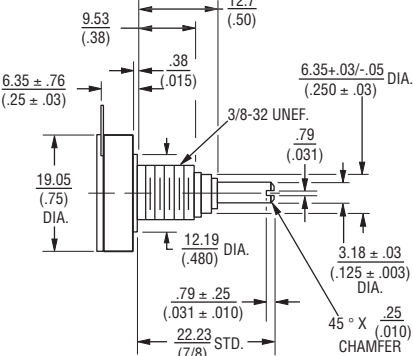

DIMENSIONS: MM (INCHES)

## Shaft End Detail

### 3850 Family

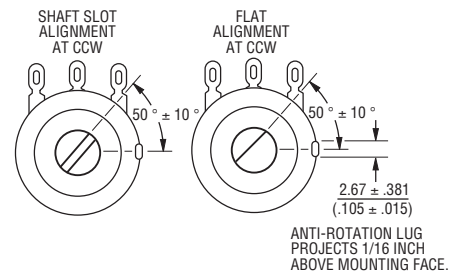

TOLERANCES EXCEPT AS NOTED:  
 DECIMALS: .XXX ± .127 .XX ± .38 (.005),  
 FRACTIONS: ± 1/64  
 ANGLE: ± 3%

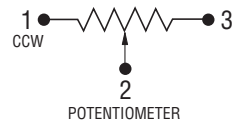

Specifications are subject to change without notice. The device characteristics and parameters in this data sheet can and do vary in different applications and actual device performance may vary over time. Users should verify actual device performance in their specific applications.

# 3851/3852/3856 - 3/4 " Diameter Panel Control

# BOURNS®

## How To Order

**3852 A - 28 2 - 103 A L**

| SHAFT TYPE (FMS) & DIAMETER |  | AVAILABLE ONLY IN  |           |
|-----------------------------|--|--------------------|-----------|
|                             |  | MODELS             | BUSHINGS  |
| 12                          | 3/8 " (9.53 mm) L X 1/8 " (3.18 mm) D  | 3851, 3852         | C         |
| 16                          | 1/2 " (12.7 mm) L x 1/4 " (6.35 mm) D  | 3851, 3852         | A         |
| 16                          | 1/2 " (12.7 mm) L x 1/8 " (3.18 mm) D  | 3851, 3852         | C, E      |
| 20                          | 5/8 " (15.88 mm) L X 1/4 " (6.35 mm) D | 3851, 3852         | A, B      |
| 28                          | 7/8 " (22.20 mm) L X 1/4 " (6.35 mm) D | 3851, 3852<br>3856 | A, B<br>A |
| 28                          | 7/8 " (22.20 mm) L X 1/8 " (3.18 mm) D | 3851, 3852<br>3856 | C, E<br>H |

Consult factory for lengths not shown.

| BUSHING   | APPLICABLE MODELS      |
|---|------------------------|
| A Plain 3/8 " (9.53 mm) D x 3/8 " (9.53 mm) L   | 3851, 3852, 3856       |
| B Locking 3/8 " (9.53 mm) D x 1/2 " (12.7 mm) L | 3851, 3852             |
| C Plain 1/4 " (6.35 mm) D x 1/4 " (6.35 mm) L   | 3851, 3852             |
| E Locking 1/4 " (6.35 mm) D x 1/2 " (12.7 mm) L | 3851, 3852             |
| H Plain 3/8 " (9.53 mm) D x 3/8 " (9.53 mm) L   | 3856 (3.18 mm D Shaft) |

| MODEL |                                       |
|-------|---------------------------------------|
| 3851  | 3/4 " (19.05 mm) D Single-Turn C.P.   |
| 3852  | 3/4 " (19.05 mm) D Single-Turn Cermet |
| 3856  | 3/4 " (19.05 mm) D 3-3/4-Turn Cermet  |

**Boldface features are Bourns standard options.**  
All others are available with higher minimum order quantities.

| TERMINAL STYLE AND SHAFT TYPE |                                 |
|-------------------------------|---------------------------------|
| 1                             | Solder Lugs, Plain End          |
| 2                             | <b>Solder Lugs, Slotted End</b> |
| 3                             | Solder Lugs, Flatted Shaft      |
| 5                             | PC Pins, Plain End              |
| 6                             | <b>PC Pins, Slotted End</b>     |
| 7                             | PC Pins, Flatted Shaft          |

| RESISTANCE CODE/VALUE (IN OHMS)<br>Model 3851 |       |
|---|-------|
| (102)   | 1 K   |
| (252)   | 2.5 K |
| (502)   | 5 K   |
| (103)   | 10 K  |
| (253)   | 25 K  |
| (503)   | 50 K  |
| (104)   | 100 K |
| (254)   | 250 K |
| (504)   | 500 K |
| (105)   | 1 M   |
| Models 3852/3856                              |       |
| (101)   | 100   |
| (251)   | 250   |
| (501)   | 500   |
| (102)   | 1 K   |
| (252)   | 2.5 K |
| (502)   | 5 K   |
| (103)   | 10 K  |
| (253)   | 25 K  |
| (503)   | 50 K  |
| (104)   | 100 K |
| (254)   | 250 K |
| (504)   | 500 K |
| (105)   | 1 M   |

| RoHS IDENTIFIER |           |
|-----------------|-----------|
| L               | Compliant |

| ELEMENT TAPER/TOLERANCE | APPLICABLE MODELS |
|-------------------------|-------------------|
| A Linear ±10 %          | 3852, 3856        |
| B Linear ±20 %          | 3851              |
| C Audio CW ±10 %        | 3852, 3856        |
| D Audio CW ±20 %        | 3851              |
| E Linear ±10 %          | 3851              |
| F Audio CCW ±10 %       | 3852, 3856        |
| G Audio CCW ±20 %       | 3851              |
| H Linear ±5 %           | 3852, 3856        |

REV. 03/15

Specifications are subject to change without notice.

The device characteristics and parameters in this data sheet can and do vary in different applications and actual device performance may vary over time. Users should verify actual device performance in their specific applications.

Компания «Океан Электроники» предлагает заключение долгосрочных отношений при поставках импортных электронных компонентов на взаимовыгодных условиях!

Наши преимущества:

- Поставка оригинальных импортных электронных компонентов напрямую с производств Америки, Европы и Азии, а так же с крупнейших складов мира;
- Широкая линейка поставок активных и пассивных импортных электронных компонентов (более 30 млн. наименований);
- Поставка сложных, дефицитных, либо снятых с производства позиций;
- Оперативные сроки поставки под заказ (от 5 рабочих дней);
- Экспресс доставка в любую точку России;
- Помощь Конструкторского Отдела и консультации квалифицированных инженеров;
- Техническая поддержка проекта, помощь в подборе аналогов, поставка прототипов;
- Поставка электронных компонентов под контролем ВП;
- Система менеджмента качества сертифицирована по Международному стандарту ISO 9001;
- При необходимости вся продукция военного и аэрокосмического назначения проходит испытания и сертификацию в лаборатории (по согласованию с заказчиком);
- Поставка специализированных компонентов военного и аэрокосмического уровня качества (Xilinx, Altera, Analog Devices, Intersil, Interpoint, Microsemi, Actel, Aeroflex, Peregrine, VPT, Syfer, Eurofarad, Texas Instruments, MS Kennedy, Miteq, Cobham, E2V, MA-COM, Hittite, Mini-Circuits, General Dynamics и др.);

Компания «Океан Электроники» является официальным дистрибьютором и эксклюзивным представителем в России одного из крупнейших производителей разъемов военного и аэрокосмического назначения «JONHON», а так же официальным дистрибьютором и эксклюзивным представителем в России производителя высокотехнологичных и надежных решений для передачи СВЧ сигналов «FORSTAR».



## JONHON

«JONHON» (основан в 1970 г.)

Разъемы специального, военного и аэрокосмического назначения:

(Применяются в военной, авиационной, аэрокосмической, морской, железнодорожной, горно- и нефтедобывающей отраслях промышленности)

«FORSTAR» (основан в 1998 г.)

ВЧ соединители, коаксиальные кабели, кабельные сборки и микроволновые компоненты:

(Применяются в телекоммуникациях гражданского и специального назначения, в средствах связи, РЛС, а так же военной, авиационной и аэрокосмической отраслях промышленности).



Телефон: 8 (812) 309-75-97 (многоканальный)

Факс: 8 (812) 320-03-32

Электронная почта: [ocean@oceanchips.ru](mailto:ocean@oceanchips.ru)

Web: <http://oceanchips.ru/>

Адрес: 198099, г. Санкт-Петербург, ул. Калинина, д. 2, корп. 4, лит. А