

### Features

- Efficiency up to 96%
- Only 40µA(TYP.) Quiescent Current
- Output Current: Up to 1A
- Internal Synchronous Rectifier
- 1.5MHz Switching Frequency
- Soft Start
- Under-Voltage Lockout
- Short Circuit Protection
- Thermal Shutdown
- 5-pin Small SOT23-5, DFN2x2 6-Pin and QFN3x3 16-Pin Packages
- Pb-Free Package

### Applications

- Cellular Phone
- Portable Electronics
- Wireless Devices
- Cordless Phone
- Computer Peripherals
- Battery Powered Widgets
- Electronic Scales
- Digital Frame

### General Description

The PAM2305 is a step-down current-mode, DC-DC converter. At heavy load, the constant-frequency PWM control performs excellent stability and transient response. To ensure the longest battery life in portable applications, the PAM2305 provides a power-saving Pulse-Skipping Modulation (PSM) mode to reduce quiescent current under light load operation to save power.

The PAM2305 supports a range of input voltages from 2.5V to 5.5V, allowing the use of a single Li+/Li-polymer cell, multiple Alkaline/NiMH cell, USB, and other standard power sources. The output voltage is adjustable from 0.6V to the input voltage, while the part number suffix PAM2305-XX indicates pre-set output voltage of 3.3V, 2.8V, 2.5V, 1.8V, 1.5V, 1.2V or adjustable. All versions employ internal power switch and synchronous rectifier for to minimize external part count and realize high efficiency. During shutdown, the input is disconnected from the output and the shutdown current is less than 0.1µA. Other key features include under-voltage lockout to prevent deep battery discharge.

The PAM2305 is available in SOT23-5, DFN2x2 6-Pin and QFN3x3 16-Pin packages.

### Typical Application

**Fixed Output Voltage**

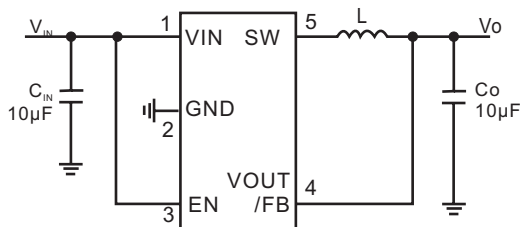

**Adjustable Output Voltage**

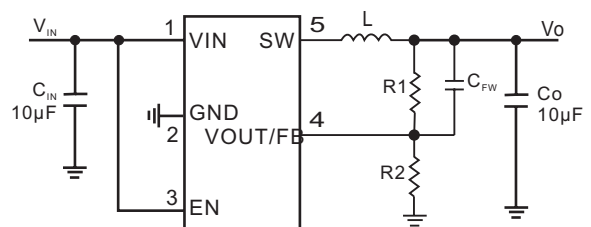

$$V_o = 0.6 \times \left( 1 + \frac{R1}{R2} \right)$$

### Block Diagram

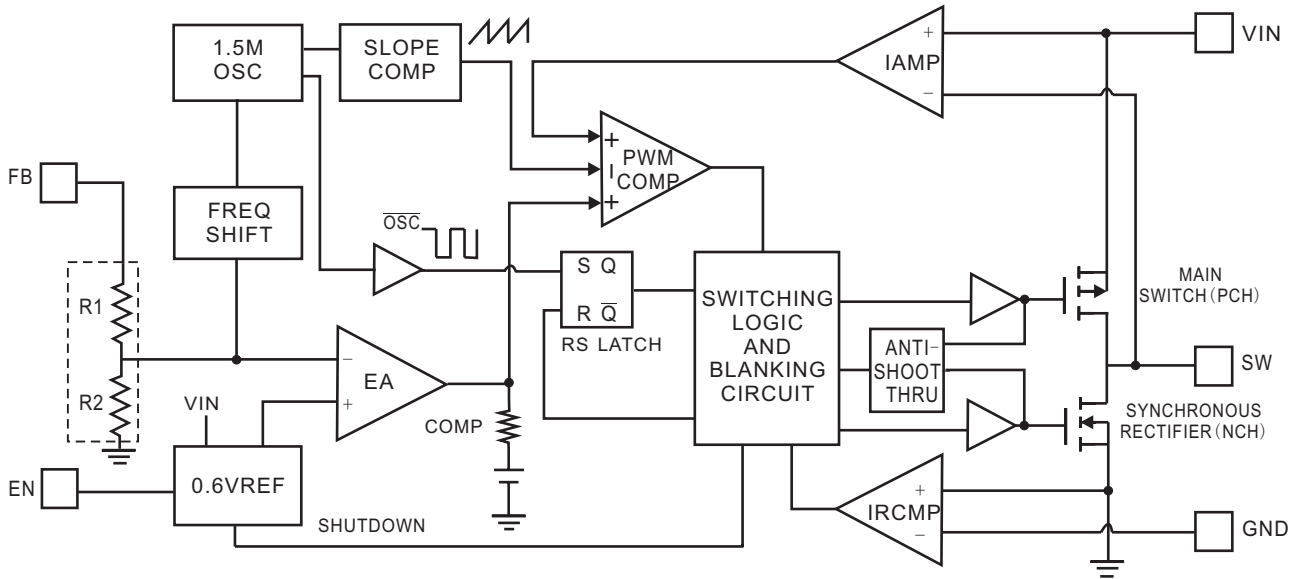

### Pin Configuration & Marking Information

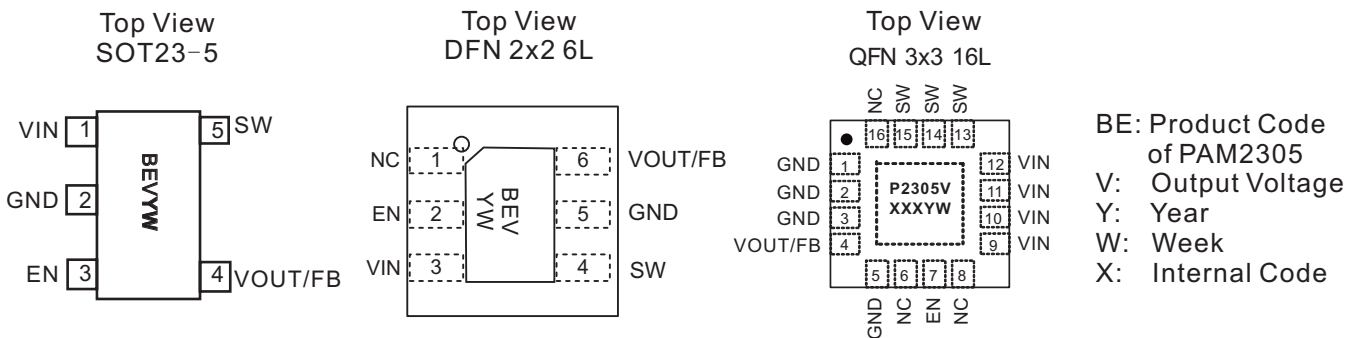

### Pin Description

Name	Function
VIN	Chip main power supply pin
GND	Ground
EN	Enable control input. Force this pin voltage above 1.5V, enables the chip, and below 0.3V shuts down the device.
VOUT/FB	VOUT: Output voltage feedback pin, an internal resistive divider divides the output voltage down for comparison to the internal reference voltage. FB: Feedback voltage to internal error amplifier, the threshold voltage is 0.6V.
SW	The drains of the internal main and synchronous power MOSFET.
NC	No connection

### Absolute Maximum Ratings

These are stress ratings only and functional operation is not implied. Exposure to absolute maximum ratings for prolonged time periods may affect device reliability. All voltages are with respect to ground.

Input Voltage.....-0.3V to 6.6V	Junction Temperature.....125°C
EN, FB Pin Voltage.....-0.3V to $V_{IN}$	Storage Temperature Range.....-65°C to 150°C
SW Pin Voltage.....-0.3V to $(V_{IN}+0.3V)$	Soldering Temperature.....300°C, 5sec

### Recommended Operating Conditions

Supply Voltage.....2.5V to 5.5V	Ambient Temperature Range.....-40°C to 85°C
Max. Supply Voltage (for Max. duration of 30 minutes).....6.0V	

### Thermal Information

Parameter	Package	Symbol	Maximum	Unit
Thermal Resistance (Junction to Case)	SOT23-5 <sup>Note</sup>	$\theta_{JC}$	130	°C/W
	DFN 2x2		20	
	QFN 3x3		12	
Thermal Resistance (Junction to Ambient)	SOT23-5	$\theta_{JA}$	102	
	DFN 2x2		68	
	QFN 3x3		34	
Internal Power Dissipation	SOT23-5	$P_D$	400	mW
	DFN 2x2		980	
	QFN 3x3		1470	

**Note:**

The maximum output current for SOT23-5 package is limited by internal power dissipation capacity as described in Application Information hereinafter.

### Electrical Characteristic

$T_A=25^{\circ}\text{C}$ ,  $V_{IN}=3.6\text{V}$ ,  $V_O=1.8\text{V}$ ,  $C_{IN}=10\mu\text{F}$ ,  $C_O=10\mu\text{F}$ ,  $L=4.7\mu\text{H}$ , unless otherwise noted.

PARAMETER	SYMBOL	Test Conditions	MIN	TYP	MAX	UNITS
Input Voltage Range	$V_{IN}$		2.5		5.5	V
Regulated Feedback Voltage	$V_{FB}$		0.588	0.6	0.612	V
Reference Voltage Line Regulation	$\Delta V_{FB}$			0.3		%/V
Regulated Output Voltage Accuracy	$V_O$	$I_O = 100\text{mA}$	-3		+3	%
Peak Inductor Current	$I_{PK}$	$V_{IN}=3\text{V}, V_{FB} = 0.5\text{V}$ or $V_O=90\%$		1.5		A
Output Voltage Line Regulation	LNR	$V_{IN} = 2.5\text{V to } 5\text{V}, I_O=10\text{mA}$		0.2	0.5	%/V
Output Voltage Load Regulation	LDR	$I_O=1\text{mA to } 800\text{mA}$		0.5	1.5	%
Quiescent Current	$I_Q$	No load		40	70	$\mu\text{A}$
Shutdown Current	$I_{SD}$	$V_{EN} = 0\text{V}$		0.1	1	$\mu\text{A}$
Oscillator Frequency	$f_{OSC}$	$V_O = 100\%$	1.2	1.5	1.8	MHz
		$V_{FB} = 0\text{V}$ or $V_O = 0\text{V}$		500		kHz
Drain-Source On-State Resistance	$R_{DS(ON)}$	$I_{DS}=100\text{mA}$	P MOSFET	0.3	0.45	$\Omega$
			N MOSFET	0.35	0.5	$\Omega$
SW Leakage Current	$I_{LSW}$			$\pm 0.01$	1	$\mu\text{A}$
High Efficiency	$\eta$			96		%
EN Threshold High	$V_{EH}$		1.5			V
EN Threshold Low	$V_{EL}$				0.3	V
EN Leakage Current	$I_{EN}$			$\pm 0.01$		$\mu\text{A}$
Over Temperature Protection	OTP			150		$^{\circ}\text{C}$
OTP Hysteresis	OTH			30		$^{\circ}\text{C}$

### Typical Performance Characteristics

$T_A=25^\circ\text{C}$ ,  $C_{IN}=10\mu\text{F}$ ,  $C_O=10\mu\text{F}$ ,  $L=4.7\mu\text{H}$ , unless otherwise noted.

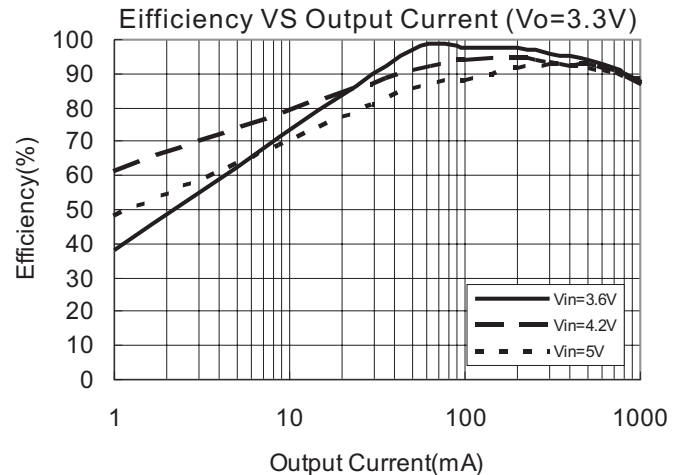
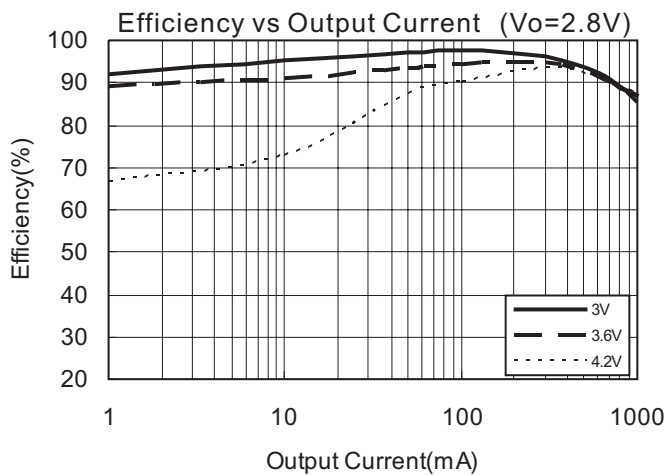
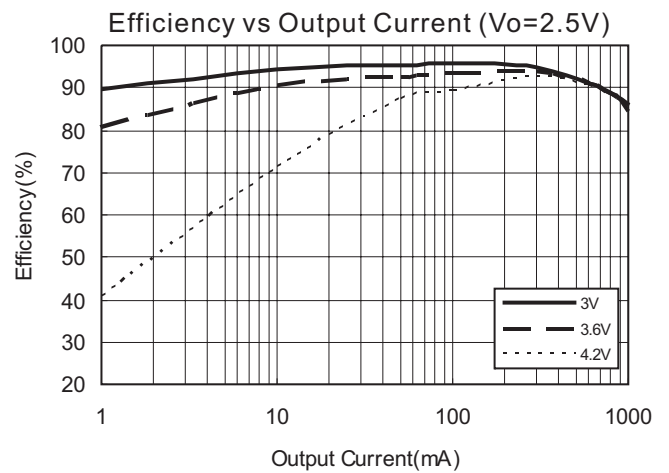
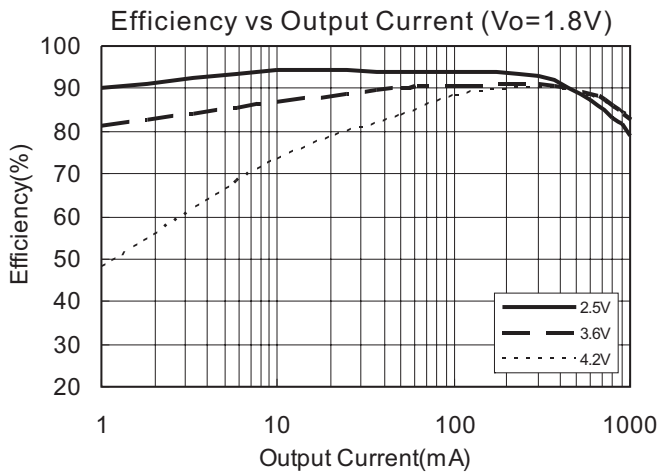
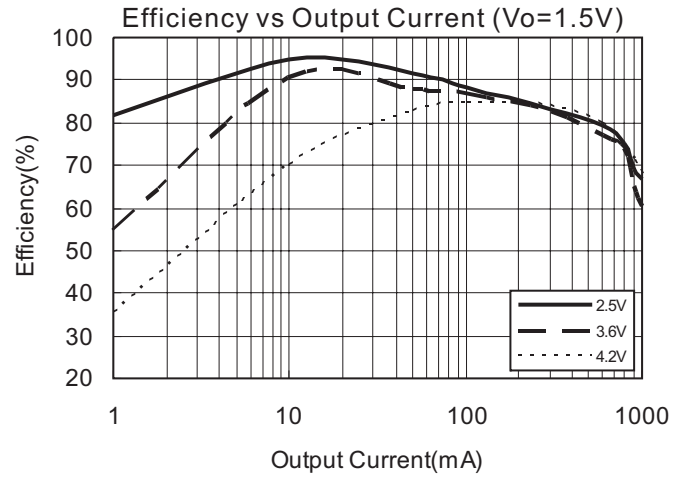
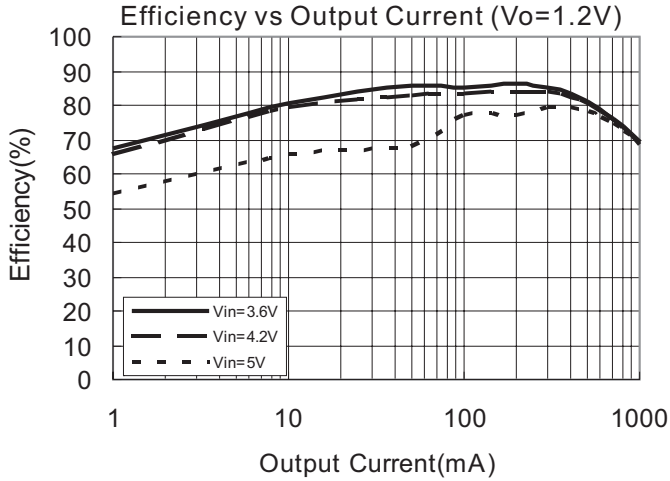

### Typical Performance Characteristics

$T_A=25^\circ\text{C}$ ,  $C_{IN}=10\mu\text{F}$ ,  $C_O=10\mu\text{F}$ ,  $L=4.7\mu\text{H}$ , unless otherwise noted.

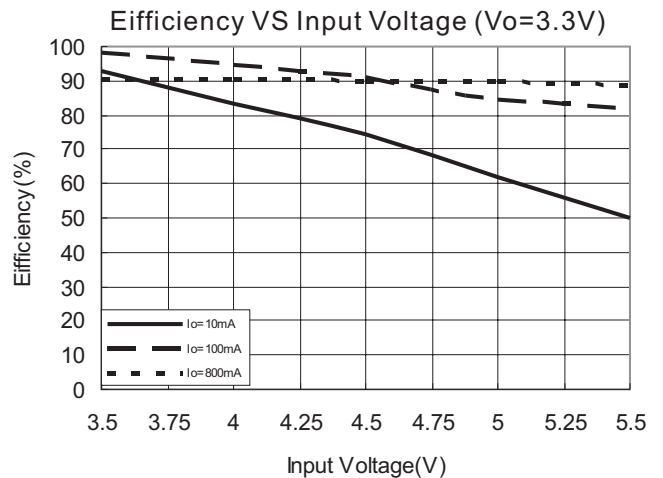
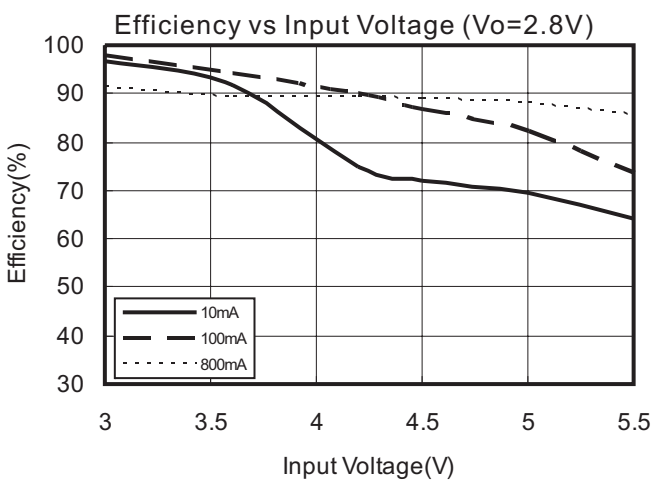
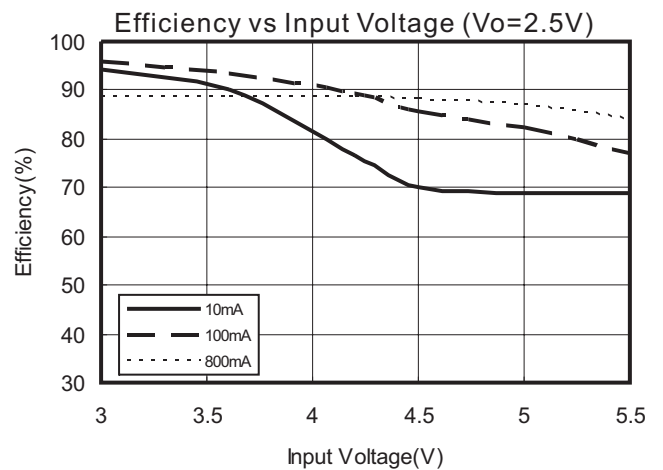
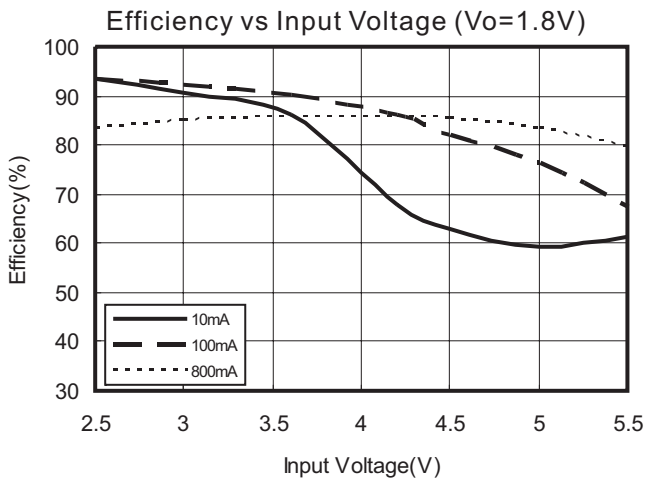
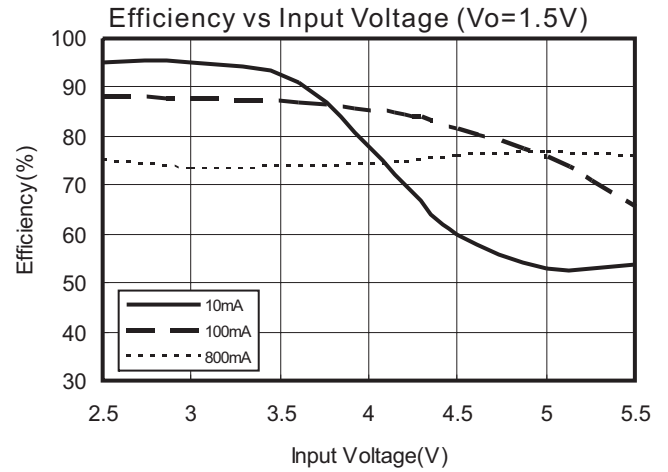
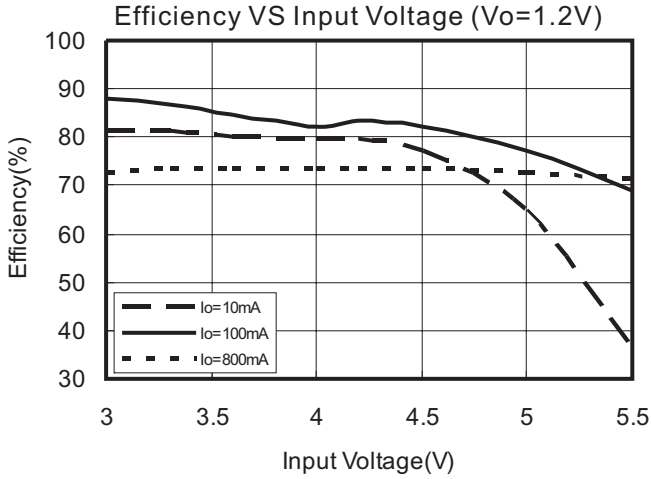

### Typical Performance Characteristics

$T_A=25^\circ\text{C}$ ,  $C_{IN}=10\mu\text{F}$ ,  $C_O=10\mu\text{F}$ ,  $L=4.7\mu\text{H}$ , unless otherwise noted.

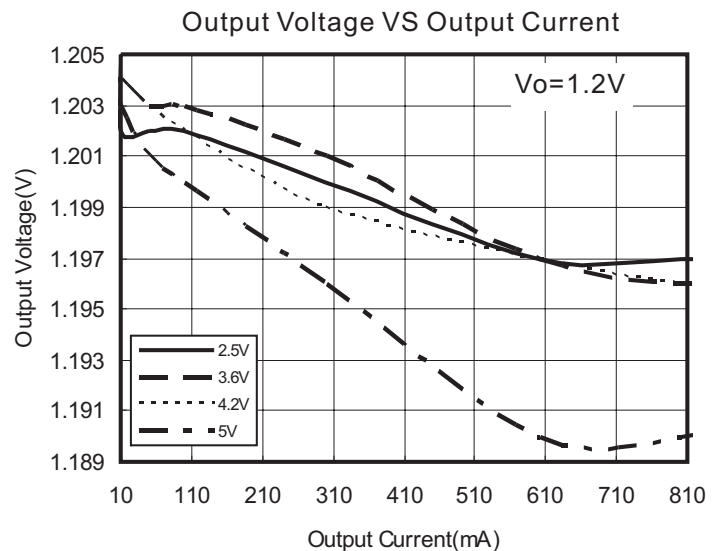
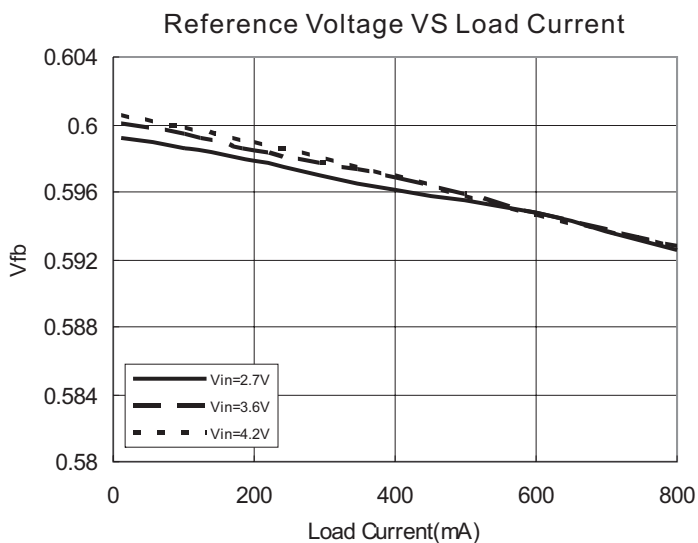
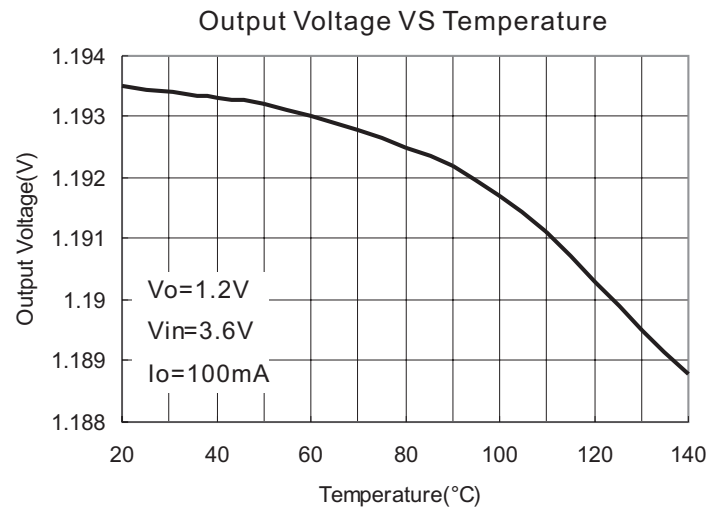
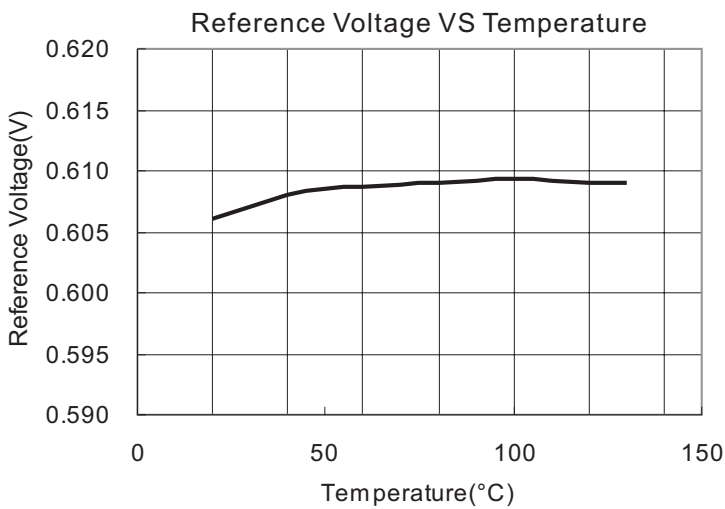
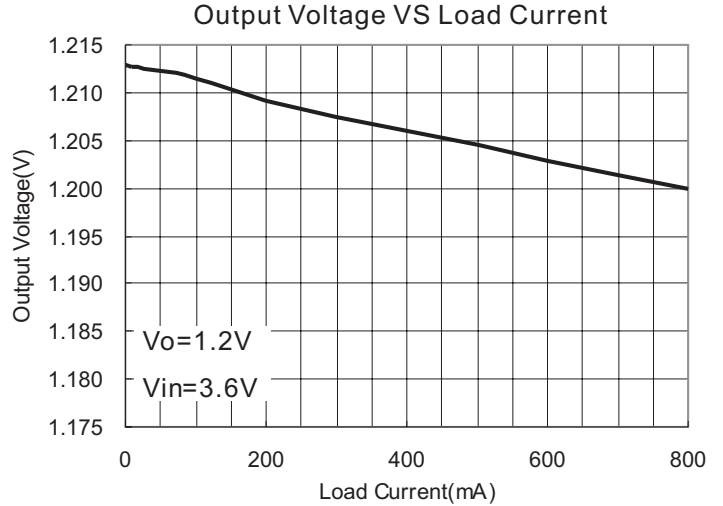
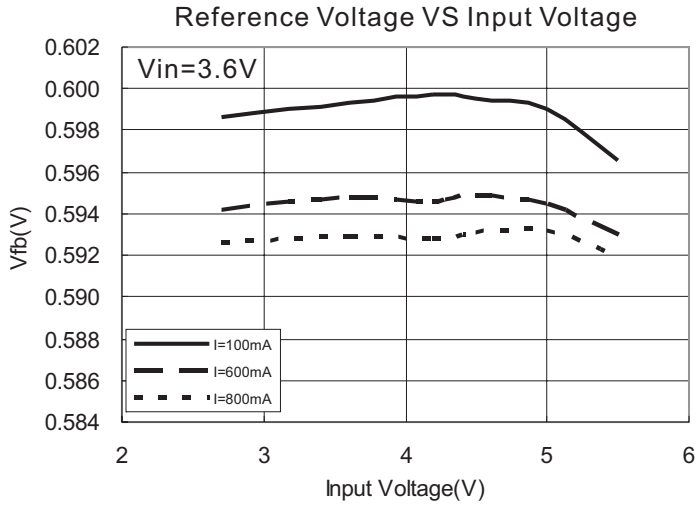

### Typical Performance Characteristics

$T_A=25^{\circ}\text{C}$ ,  $C_{IN}=10\mu\text{F}$ ,  $C_O=10\mu\text{F}$ ,  $L=4.7\mu\text{H}$ , unless otherwise noted.

Dynamic Supply Current VS Input Voltage

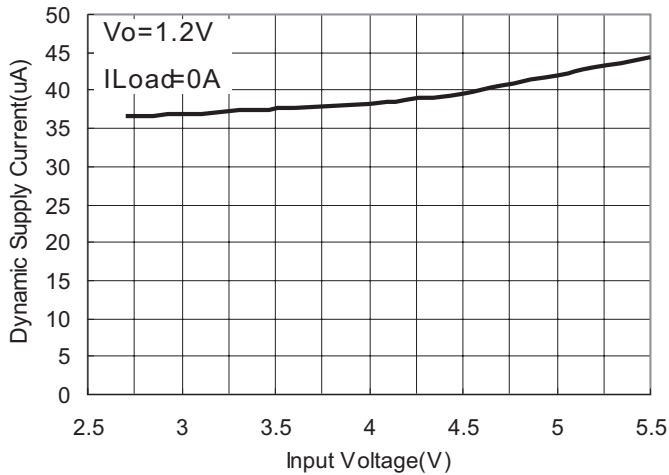

Dynamic Supply Current VS Temperature

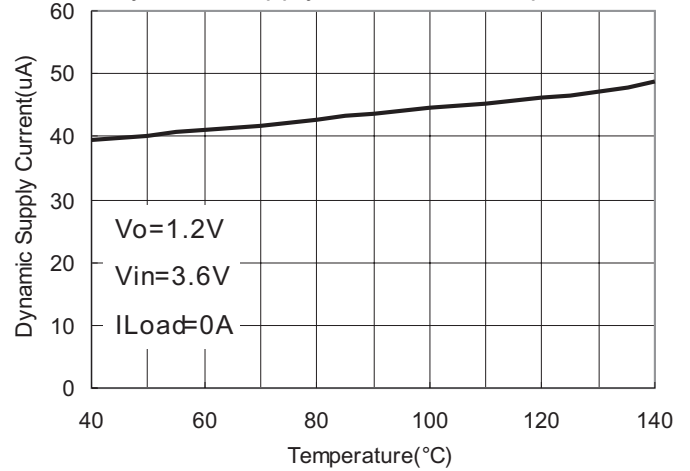

Rdson VS Input Voltage

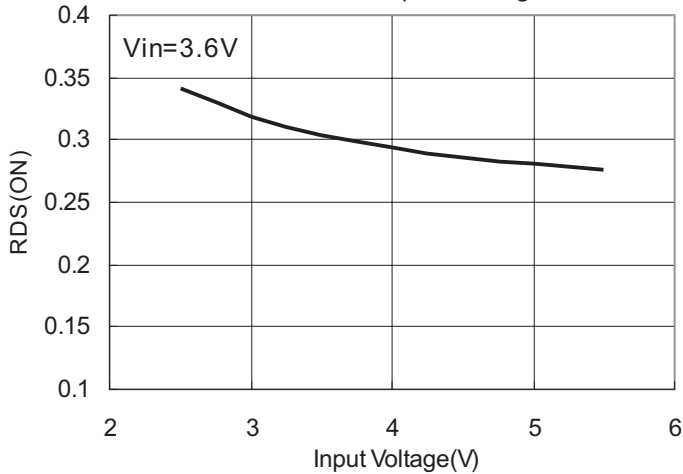

Rdson VS Temperature

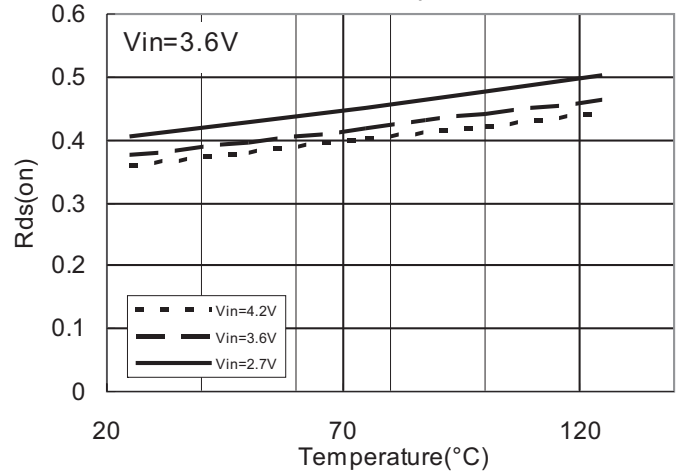

Oscillator Frequency VS Supply Voltage

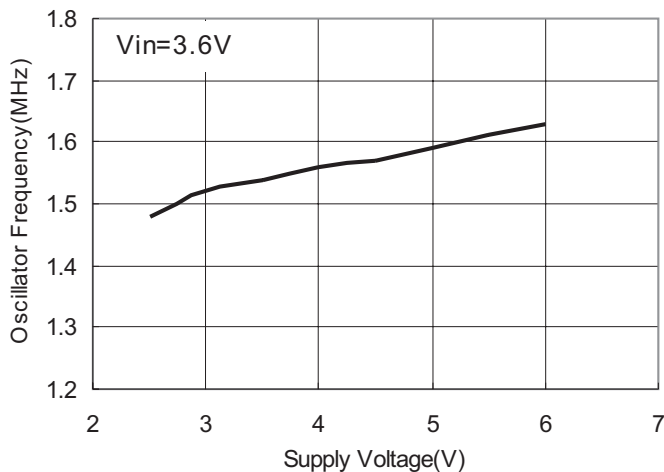

Oscillator Frequency VS Temperature

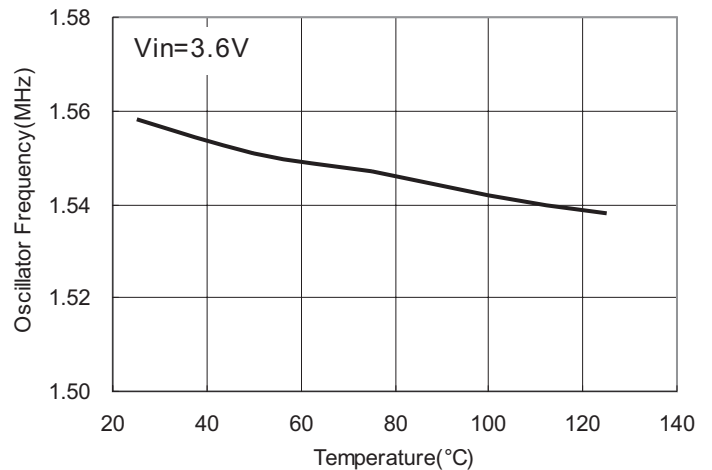



### Typical Performance Characteristics

$T_A=25^{\circ}\text{C}$ ,  $C_{IN}=10\mu\text{F}$ ,  $C_O=10\mu\text{F}$ ,  $L=4.7\mu\text{H}$ , unless otherwise noted.

Load Transient  
 $I_o=0-500\text{mA}$   $V_o=3.3\text{V}$   $V_{in}=5\text{V}$

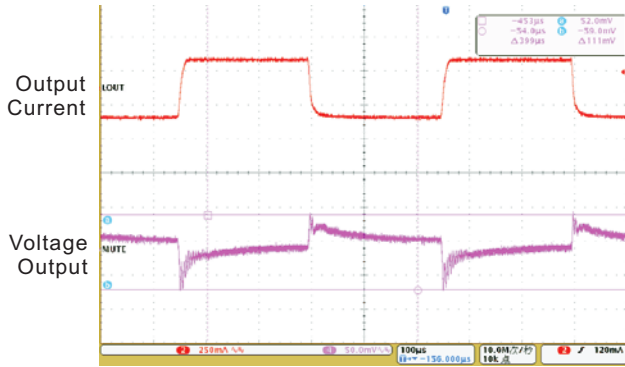

Load Transient  
 $I_o=0-1\text{A}$   $V_o=1.2\text{V}$   $V_{in}=3.6\text{V}$

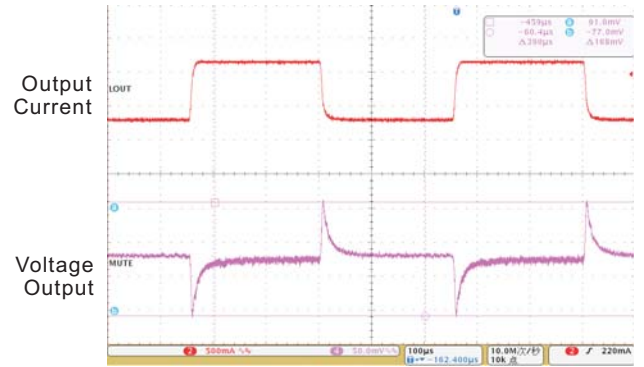

Start-up from Shutdown  
 $V_o=1.8\text{V}$ ,  $V_{in}=3.6\text{V}$

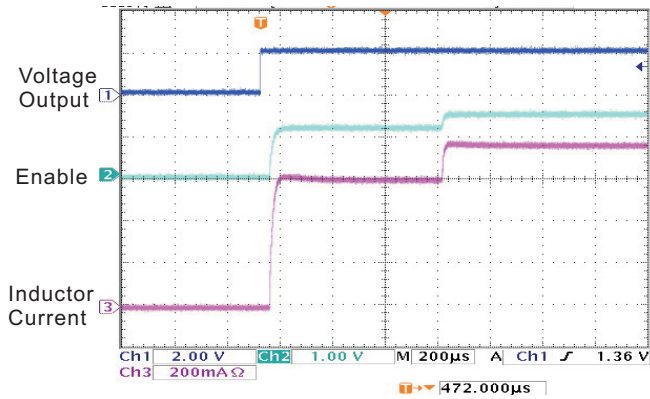

### Application Information

The basic PAM2305 application circuit is shown in Page 1. External component selection is determined by the load requirement, selecting L first and then Cin and Cout.

#### Inductor Selection

For most applications, the value of the inductor will fall in the range of 1μH to 4.7μH. Its value is chosen based on the desired ripple current. Large value inductors lower ripple current and small value inductors result in higher ripple currents. Higher VIN or Vout also increases the ripple current as shown in equation 1. A reasonable starting point for setting ripple current is ΔIL = 400mA (40% of 1A).

$$\Delta I_L = \frac{1}{(f)(L)} V_{OUT} \left( 1 - \frac{V_{OUT}}{V_{IN}} \right) \quad (1)$$

The DC current rating of the inductor should be at least equal to the maximum load current plus half the ripple current to prevent core saturation. Thus, a 1.4A rated inductor should be enough for most applications (1A + 400mA). For better efficiency, choose a low DC-resistance inductor.

Vo	1.2V	1.5V	1.8V	2.5V	3.3V
L	2.2μH	2.2μH	2.2μH	4.7μH	4.7μH

#### CIN and COUT Selection

In continuous mode, the source current of the top MOSFET is a square wave of duty cycle Vout/Vin. To prevent large voltage transients, a low ESR input capacitor sized for the maximum RMS current must be used. The maximum RMS capacitor current is given by:

$$C_{IN} \text{ required } I_{RMS} \cong I_{OMAX} \frac{[V_{OUT}(V_{IN} - V_{OUT})]^{1/2}}{V_{IN}}$$

This formula has a maximum at VIN = 2Vout, where IRMS = IOUT/2. This simple worst-case condition is commonly used for design because even significant deviations do not offer much relief. Note that the capacitor manufacturer's ripple current ratings are often based on 2000 hours of life. This makes it advisable to further derate the capacitor, or choose a capacitor rated at a higher temperature than required. Consult the manufacturer if there is any question.

The selection of Cout is driven by the required effective series resistance (ESR).

Typically, once the ESR requirement for Cout has been met, the RMS current rating generally far exceeds the I<sub>ripple</sub>(P-P) requirement. The output ripple ΔVout is determined by:

$$\Delta V_{OUT} \cong \Delta I_L \left( ESR + \frac{1}{8fC_{OUT}} \right)$$

Where f = operating frequency, C<sub>OUT</sub> = output capacitance and ΔIL = ripple current in the inductor. For a fixed output voltage, the output ripple is highest at maximum input voltage since ΔIL increases with input voltage.

#### Using Ceramic Input and Output Capacitors

Higher values, lower cost ceramic capacitors are now becoming available in smaller case sizes. Their high ripple current, high voltage rating and low ESR make them ideal for switching regulator applications. Using ceramic capacitors can achieve very low output ripple and small circuit size.

When choosing the input and output ceramic capacitors, choose the X5R or X7R dielectric formulations. These dielectrics have the best temperature and voltage characteristics of all the ceramics for a given value and size.

#### Thermal consideration

Thermal protection limits power dissipation in the PAM2305. When the junction temperature exceeds 150°C, the OTP (Over Temperature Protection) starts the thermal shutdown and turns the pass transistor off. The pass transistor resumes operation after the junction temperature drops below 120°C.

For continuous operation, the junction temperature should be maintained below 125°C. The power dissipation is defined as:

$$P_D = I_o^2 \frac{V_o R_{DS(ON)H} + (V_{IN} - V_o) R_{DS(ON)L}}{V_{IN}} + (t_{sw} F_s I_o + I_Q) V_{IN}$$

I<sub>o</sub> is the step-down converter quiescent current. The term tsw is used to estimate the full load step-down converter switching losses.

For the condition where the step-down converter is in dropout at 100% duty cycle, the total device dissipation reduces to:

$$P_D = I_o^2 R_{DS(ON)} + I_Q V_{IN}$$

Since  $R_{DS(ON)}$ , quiescent current, and switching losses all vary with input voltage, the total losses should be investigated over the complete input voltage range. The maximum power dissipation depends on the thermal resistance of IC package, PCB layout, the rate of surrounding airflow and temperature difference between junction and ambient. The maximum power dissipation can be calculated by the following formula:

$$P_D = \frac{T_{J(MAX)} - T_A}{\theta_{JA}}$$

Where  $T_J(max)$  is the maximum allowable junction temperature  $125^\circ C$ .  $T_A$  is the ambient temperature and  $\theta_{JA}$  is the thermal resistance from the junction to the ambient. Based on the standard JEDEC for a two layers thermal test board, the thermal resistance  $\theta_{JA}$  of SOT23-5 package is  $250^\circ C/W$ , DFN2X2  $102^\circ C/W$ , and QFN3X3  $68^\circ C/W$ , respectively. The maximum power dissipation at  $T_A = 25^\circ C$  can be calculated by following formula:

SOT-25 package:

$$P_D = (125^\circ C - 25^\circ C) / 250^\circ C/W = 0.4W$$

DFN2\*2 package:

$$P_D = (125^\circ C - 25^\circ C) / 102^\circ C/W = 0.984W$$

QFN3\*3 package:

$$P_D = (125^\circ C - 25^\circ C) / 68^\circ C/W = 1.47W$$

### Setting the Output Voltage

The internal reference is 0.6V (Typical). The output voltage is calculated as below:

$$V_o = 0.6 \times \left( 1 + \frac{R1}{R2} \right)$$

The output voltage is given by Table 1.

**Table 1:** Resistor selection for output voltage setting

Vo	R1	R2
1.2V	100k	100k
1.5V	150k	100k
1.8V	200k	100k
2.5V	380k	120k
3.3V	540k	120k

### 100% Duty Cycle Operation

As the input voltage approaches the output voltage, the converter turns the P-channel transistor continuously on. In this mode the output voltage is equal to the input voltage minus the voltage drop across the P - channel transistor:

$$V_{OUT} = V_{IN} - I_{LOAD} (R_{dson} + R_L)$$

where  $R_{dson}$  = P-channel switch ON resistance,  $I_{LOAD}$  = Output current,  $R_L$  = Inductor DC resistance

### UVLO and Soft-Start

The reference and the circuit remain reset until the VIN crosses its UVLO threshold.

The PAM2305 has an internal soft-start circuit that limits the in-rush current during start-up. This prevents possible voltage drops of the input voltage and eliminates the output voltage overshoot. The soft-start acts as a digital circuit to increase the switch current in several steps to the P-channel current limit (1500mA).

### Short Circuit Protection

The switch peak current is limited cycle-by-cycle to a typical value of 1500mA. In the event of an output voltage short circuit, the device operates with a frequency of 400kHz and minimum duty cycle, therefore the average input current is typically 200mA.

### Thermal Shutdown

When the die temperature exceeds  $150^\circ C$ , a reset occurs and the reset remains until the temperature decrease to  $120^\circ C$ , at which time the circuit can be restarted.

### PCB Layout Check List

When laying out the printed circuit board, the following checklist should be used to ensure proper operation of the PAM2305. These items are also illustrated graphically in Figure 1. Check the following in your layout:

1. The power traces, consisting of the GND trace, the SW trace and the VIN trace should be kept short, direct and wide.
2. Does the  $V_{FB}$  pin connect directly to the feedback resistors? The resistive divider R1/R2 must be connected between the (+) plate of  $C_{OUT}$  and ground.
3. Does the (+) plate of  $C_{IN}$  connect to VIN as closely as possible? This capacitor provides the AC current to the internal power MOSFETs.
4. Keep the switching node, SW, away from the sensitive VFB node.
5. Keep the (-) plates of  $C_{IN}$  and  $C_{OUT}$  as close as possible.

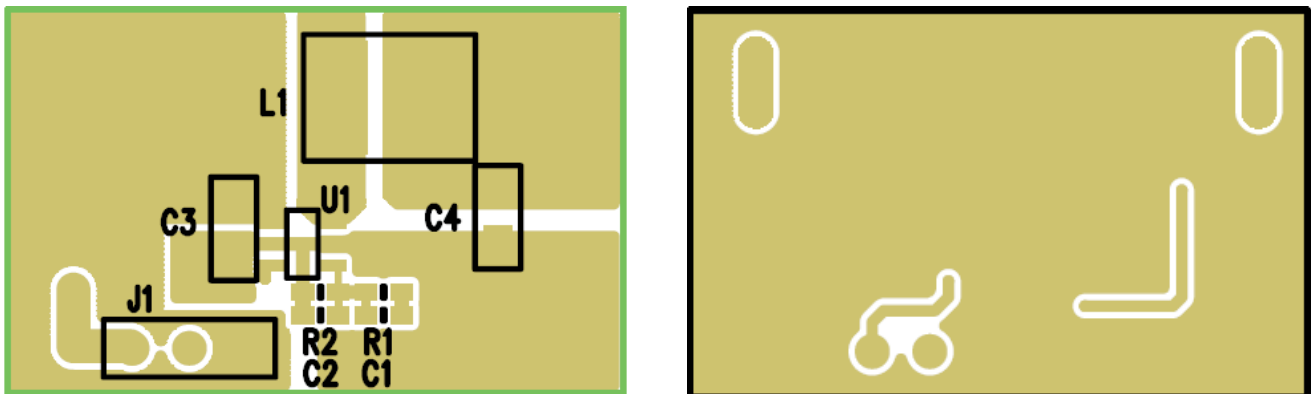
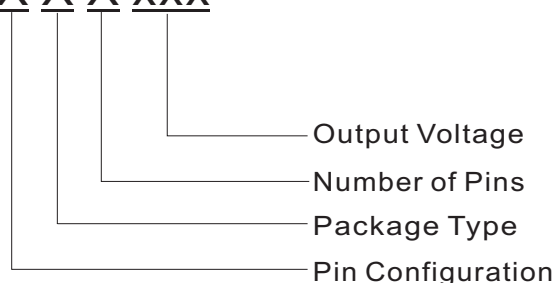

Figure 1 :PAM2305 Suggested Layout

## Ordering Information

PAM 2305 X X X xxx



Pin Configuration	Package Type	Number of Pins	Output Voltage
A Type	A: SOT-23	B: 5	330: 3.3V
1. VIN	J: QFN 3x3	E: 16	280: 2.8V
2. GND	G: DFN 2x2	F: 6	250: 2.5V
3. EN			180: 1.8V
4. VOUT/FB			150: 1.5V
5. SW			120: 1.2V
B Type :			ADJ: Adjustable
16 pins			
C Type:			
1. NC			
2. EN			
3. VIN			
4. SW			
5. GND			
6 : VOUT/FB			



## Ordering Information

Part Number	Output Voltage	Marking	Package Type	Standard Package
PAM2305AAB330	3.3V	BEKYW	SOT23-5	3,000Units/Tape&Reel
PAM2305AAB280	2.8V	BEHYW	SOT23-5	3,000Units/Tape&Reel
PAM2305AAB250	2.5V	BEGYW	SOT23-5	3,000Units/Tape&Reel
PAM2305AAB180	1.8V	BEEYW	SOT23-5	3,000Units/Tape&Reel
PAM2305AAB150	1.5V	BECYW	SOT23-5	3,000Units/Tape&Reel
PAM2305AAB120	1.2V	BEBYW	SOT23-5	3,000Units/Tape&Reel
PAM2305AABADJ	ADJ	BEAYW	SOT23-5	3,000Units/Tape&Reel
PAM2305BJE330	3.3V	P2305K	QFN3x3	3,000Units/Tape&Reel
PAM2305BJE280	2.8V	P2305H	QFN3x3	3,000Units/Tape&Reel
PAM2305BJE250	2.5V	P2305G	QFN3x3	3,000Units/Tape&Reel
PAM2305BJE180	1.8V	P2305E	QFN3x3	3,000Units/Tape&Reel
PAM2305BJE150	1.5V	P2305C	QFN3x3	3,000Units/Tape&Reel
PAM2305BJE120	1.2V	P2305B	QFN3x3	3,000Units/Tape&Reel
PAM2305BJEADJ	ADJ	P2305A	QFN3x3	3,000Units/Tape&Reel
PAM2305CGF330	3.3V	BEKYW	DFN2x2-6	3,000Units/Tape&Reel
PAM2305CGF280	2.8V	BEHYW	DFN2x2-6	3,000Units/Tape&Reel
PAM2305CGF250	2.5V	BEGYW	DFN2x2-6	3,000Units/Tape&Reel
PAM2305CGF180	1.8V	BEEYW	DFN2x2-6	3,000Units/Tape&Reel
PAM2305CGF150	1.5V	BECYW	DFN2x2-6	3,000Units/Tape&Reel
PAM2305CGF120	1.2V	BEBYW	DFN2x2-6	3,000Units/Tape&Reel
PAM2305CGFADJ	ADJ	BEAYW	DFN2x2-6	3,000Units/Tape&Reel

## Outline Dimensions

SOT23-5

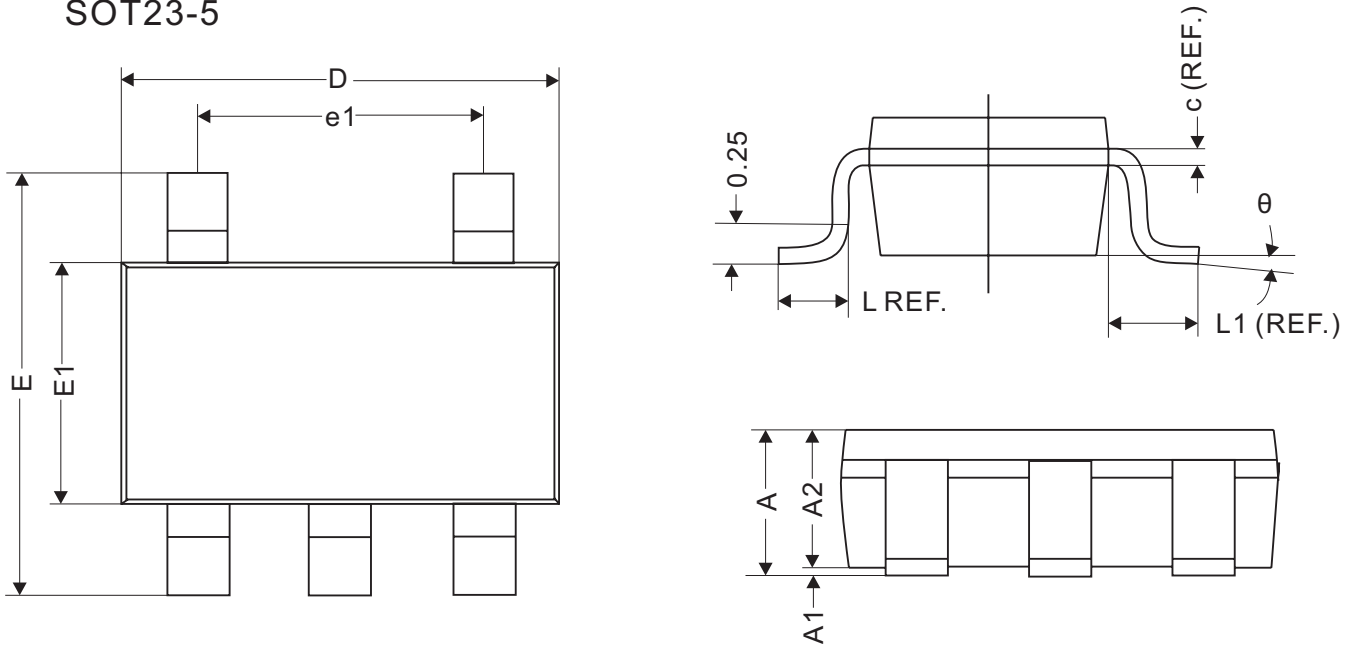

REF.	Millimeter		
	Min	Nom	Max
A	1.10MAX		
A1	0	0.05	0.10
A2	0.70	1.00	1.295
c	0.12REF.		
D	2.70	2.90	3.10
E	2.60	2.80	3.00
E1	1.40	1.60	1.80
L	0.45REF.		
L1	0.60REF.		
$\theta$	0°	5°	10°
b	0.30	0.40	0.50
e	0.95REF.		
e1	1.90REF.		

## Outline Dimensions

### DFN 2x2

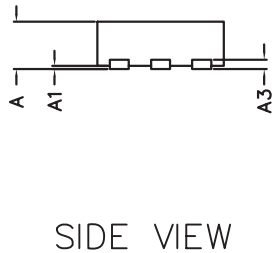
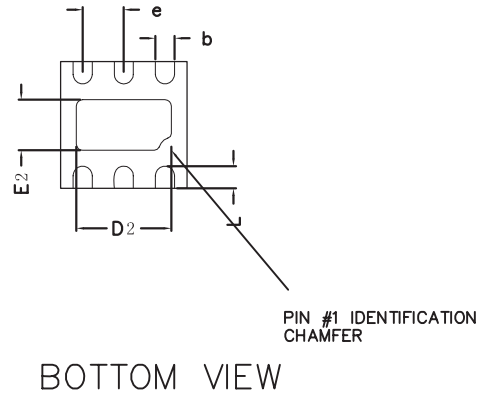
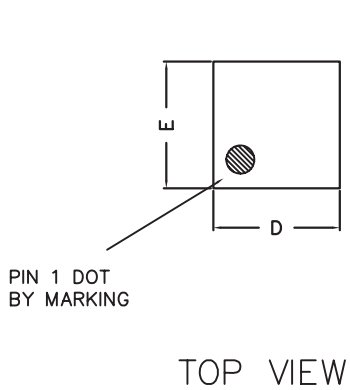

COMMON DIMENSIONS(MM)			
PKG.	W: VERY VERY THIN		
REF.	MIN.	NOM.	MAX
A	0.70	0.75	0.80
A1	0.00	-	0.05
A3	0.2 REF.		
D	1.95	2.00	2.05
E	1.95	2.00	2.05
b	0.25	0.30	0.35
L	0.25	0.35	0.45
D2	1.35	1.50	1.60
E2	0.65	0.80	0.90
e	0.65 BSC		



## Outline Dimensions

3x3 mm QFN 16

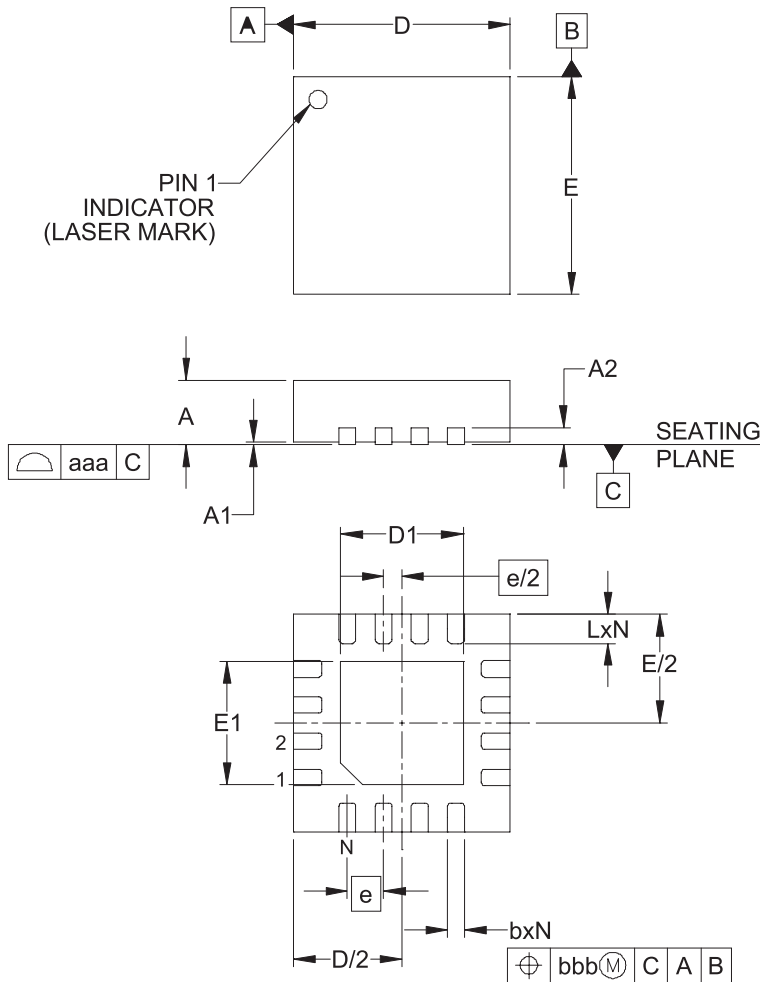

DIMENSIONS (Millimeters)			
	MIN	TYP	MAX
A	0.70	0.75	0.80
A1	0.00	0.02	0.05
A2	0.20		
b	0.18	0.25	0.30
D	2.90	3.00	3.10
D1	1.55	1.70	1.80
E	2.90	3.00	3.10
E1	1.55	1.70	1.80
e	0.50BSC		
L	0.30	0.40	0.50
N	16		
aaa	0.08		
bbb	0.10		

**NOTES:**

1. CONTROLLING DIMENSIONS ARE IN MILLIMETERS (ANGLES IN DEGREES).
2. COPLANARITY APPLIES TO THE EXPOSED PAD AS WELL AS THE TERMINALS.
3. DAP IS 1.90 x 1.90mm.

Компания «Океан Электроники» предлагает заключение долгосрочных отношений при поставках импортных электронных компонентов на взаимовыгодных условиях!

Наши преимущества:

- Поставка оригинальных импортных электронных компонентов напрямую с производств Америки, Европы и Азии, а так же с крупнейших складов мира;
- Широкая линейка поставок активных и пассивных импортных электронных компонентов (более 30 млн. наименований);
- Поставка сложных, дефицитных, либо снятых с производства позиций;
- Оперативные сроки поставки под заказ (от 5 рабочих дней);
- Экспресс доставка в любую точку России;
- Помощь Конструкторского Отдела и консультации квалифицированных инженеров;
- Техническая поддержка проекта, помощь в подборе аналогов, поставка прототипов;
- Поставка электронных компонентов под контролем ВП;
- Система менеджмента качества сертифицирована по Международному стандарту ISO 9001;
- При необходимости вся продукция военного и аэрокосмического назначения проходит испытания и сертификацию в лаборатории (по согласованию с заказчиком);
- Поставка специализированных компонентов военного и аэрокосмического уровня качества (Xilinx, Altera, Analog Devices, Intersil, Interpoint, Microsemi, Actel, Aeroflex, Peregrine, VPT, Syfer, Eurofarad, Texas Instruments, MS Kennedy, Miteq, Cobham, E2V, MA-COM, Hittite, Mini-Circuits, General Dynamics и др.);

Компания «Океан Электроники» является официальным дистрибьютором и эксклюзивным представителем в России одного из крупнейших производителей разъемов военного и аэрокосмического назначения «JONHON», а так же официальным дистрибьютором и эксклюзивным представителем в России производителя высокотехнологичных и надежных решений для передачи СВЧ сигналов «FORSTAR».



## JONHON

«JONHON» (основан в 1970 г.)

Разъемы специального, военного и аэрокосмического назначения:

(Применяются в военной, авиационной, аэрокосмической, морской, железнодорожной, горно- и нефтедобывающей отраслях промышленности)

«FORSTAR» (основан в 1998 г.)

ВЧ соединители, коаксиальные кабели, кабельные сборки и микроволновые компоненты:

(Применяются в телекоммуникациях гражданского и специального назначения, в средствах связи, РЛС, а так же военной, авиационной и аэрокосмической отраслях промышленности).



Телефон: 8 (812) 309-75-97 (многоканальный)

Факс: 8 (812) 320-03-32

Электронная почта: [ocean@oceanchips.ru](mailto:ocean@oceanchips.ru)

Web: <http://oceanchips.ru/>

Адрес: 198099, г. Санкт-Петербург, ул. Калинина, д. 2, корп. 4, лит. А