



»» Features

- 8A/12A miniature PCB Power Relay.
- Large contact gap : 2mm/1.5mm.
- High dielectric strength and comply with IEC 16950.
- Epoxy seal type and sealed flux free are both available.
- Design for UPS and power supply application.
- Complies with RoHS-Directive 2011/65/EU.

»» Type List

◆ Standard Type

Terminal style	Contact form	Contact gap	Designation (provided with)		
			Flux tight	Sealed type	Sealed type washable
PCB terminal	2A (DPNO)	1.5mm	894-2AC1-F-C	894-2AC1-F-V	894-2AC1-F-S
			894-2ACA1-F-C	894-2ACA1-F-V	894-2ACA1-F-S
		2.0mm	894-2AC2-F-C	894-2AC2-F-V	894-2AC2-F-S
			894-2ACA2-F-C	894-2ACA2-F-V	894-2ACA2-F-S
		1.5mm	894-2AH1-F-C	894-2AH1-F-V	894-2AH1-F-S
			894-2AHA1-F-C	894-2AHA1-F-V	894-2AHA1-F-S
	2.0mm	894-2AH2-F-C	894-2AH2-F-V	894-2AH2-F-S	
		894-2AHA2-F-C	894-2AHA2-F-V	894-2AHA2-F-S	
	2C (DPDT)	1.5mm	894-2CC1-F-C	894-2CC1-F-V	894-2CC1-F-S
			894-2CCA1-F-C	894-2CCA1-F-V	894-2CCA1-F-S
		2.0mm	894-2CC2-F-C	894-2CC2-F-V	894-2CC2-F-S
			894-2CCA2-F-C	894-2CCA2-F-V	894-2CCA2-F-S
		1.5mm	894-2CH1-F-C	894-2CH1-F-V	894-2CH1-F-S
			894-2CHA1-F-C	894-2CHA1-F-V	894-2CHA1-F-S
	2.0mm	894-2CH2-F-C	894-2CH2-F-V	894-2CH2-F-S	
		894-2CHA2-F-C	894-2CHA2-F-V	894-2CHA2-F-S	

◆ High Power Type

PCB terminal	2A (DPNO)	1.5mm	894H-2AC1-F-C	894H-2AC1-F-V	894H-2AC1-F-S
			894H-2ACA1-F-C	894H-2ACA1-F-V	894H-2ACA1-F-S
		2.0mm	894H-2AC2-F-C	894H-2AC2-F-V	894H-2AC2-F-S
			894H-2ACA2-F-C	894H-2ACA2-F-V	894H-2ACA2-F-S
		1.5mm	894H-2AH1-F-C	894H-2AH1-F-V	894H-2AH1-F-S
			894H-2AHA1-F-C	894H-2AHA1-F-V	894H-2AHA1-F-S
	2.0mm	894H-2AH2-F-C	894H-2AH2-F-V	894H-2AH2-F-S	
		894H-2AHA2-F-C	894H-2AHA2-F-V	894H-2AHA2-F-S	
	2C (DPDT)	1.5mm	894H-2CC1-F-C	894H-2CC1-F-V	894H-2CC1-F-S
			894H-2CCA1-F-C	894H-2CCA1-F-V	894H-2CCA1-F-S



PCB terminal	2C (DPDT)	2.0mm	894H-2CC2-F-C	894H-2CC2-F-V	894H-2CC2-F-S
			894H-2CCA2-F-C	894H-2CCA2-F-V	894H-2CCA2-F-S
		1.5mm	894H-2CH1-F-C	894H-2CH1-F-V	894H-2CH1-F-S
			894H-2CHA1-F-C	894H-2CHA1-F-V	894H-2CHA1-F-S
		2.0mm	894H-2CH2-F-C	894H-2CH2-F-V	894H-2CH2-F-S
			894H-2CHA2-F-C	894H-2CHA2-F-V	894H-2CHA2-F-S

◆ High Sensitivity Type

Terminal style	Contact form	Designation (provided with)		
		Flux tight	Sealed type	Sealed type washable
PCB terminal	2A (DPNO)	894N-2AC-F-C	894N-2AC-F-V	894N-2AC-F-S
		894N-2ACA-F-C	894N-2ACA-F-V	894N-2ACA-F-S
		894N-2AH-F-C	894N-2AH-F-V	894N-2AH-F-S
		894N-2AHA-F-C	894N-2AHA-F-V	894N-2AHA-F-S
	2C (DPDT)	894N-2CC-F-C	894N-2CC-F-V	894N-2CC-F-S
		894N-2CCA-F-C	894N-2CCA-F-V	894N-2CCA-F-S
		894N-2CH-F-C	894N-2CH-F-V	894N-2CH-F-S
		894N-2CHA-F-C	894N-2CHA-F-V	894N-2CHA-F-S

»» Ordering Information

894 - 2C C - - C
 1 2 3 4 5 6 7 8 9

- 1. 894 -- Basic series designation
- 2. Blank -- Standard type
H -- High power type
- 3. Blank -- Standard type (0.8 W; 1.4 W for 2CX2 only)
N -- High sensitivity type (0.53 W)
- 4. 2A -- Double pole normally open
2B -- Double pole normally closed
2C -- Double pole double throw
- 5. C -- Contact material AgNi
CA -- Contact material AgNi + Au
H -- Contact material AgSnO
- 6. Blank -- Standard type
1 -- Contact gap \geq 1.5mm
2 -- Contact gap \geq 2.0mm
- 7. Blank -- Standard type
F -- Class F
- 8. C -- Flux tight
V -- Sealed type
S -- Sealed type washable
- 9. -- Coil voltage (please refer to the coil rating data for the availability)

»» Contact Rating

Type	894	894H
Resistive load	8A 240VAC	NO : 12A 240VAC NC : 10A 240VAC

»» Coil Rating (DC)

◆ Standard Type

Rated voltage (V)	Rated current $\pm 10\%$ at 23°C (mA)	Coil resistance $\pm 10\%$ at 23°C (Ω)	Max. continuous voltage at 70°C	Pick up voltage(Max.) at 23°C	Drop out voltage(Min.) at 23°C	Power consumption at rated voltage
3	265	11.3	150 % of rated voltage	# of rated voltage (See note)	5 % of rated voltage	approx. 0.8W
5	161	31				
6	133	45				
9	89.1	101				
12	66.6	180				
18	44.4	405				
24	32.4	740				
48	16.7	2880				
60	13.3	4500				
110	7.3	15125				

Notes : # = 75% Contact form 2A / Contact gap 1.5mm only
 # = 85% Contact form 2C / Contact gap 1.5mm only
 # = 85% Contact form 2A / Contact gap 2.0mm only

◆ Standard Type (for "-2CX2" only)

Rated voltage (V)	Rated current $\pm 10\%$ at 23°C (mA)	Coil resistance $\pm 10\%$ at 23°C (Ω)	Max. continuous voltage at 70°C	Pick up voltage(Max.) at 23°C	Drop out voltage(Min.) at 23°C	Power consumption at rated voltage
3	468	6.4	130 % of rated voltage	85 % of rated voltage	5 % of rated voltage	approx. 1.4W
5	277	18				
6	230	26				
9	155	58				
12	117	102				
18	78	230				
24	58	410				
48	29	1650				
60	23	2570				
110	13	8640				

◆ High Sensitivity Type

Rated voltage (V)	Rated current $\pm 10\%$ at 23°C (mA)	Coil resistance $\pm 10\%$ at 23°C (Ω)	Max. continuous voltage at 70°C	Pick up voltage(Max.) at 23°C	Drop out voltage(Min.) at 23°C	Power consumption at rated voltage
3	175	17.1	150 % of rated voltage	75 % of rated voltage	5 % of rated voltage	approx. 0.53W
5	107	46.7				
6	87	68.7				
9	59	153.2				
12	44	272				
18	30	610				
24	22	1,081				
48	11	4,350				
60	8.8	6,790				
110	4.8	22,800				

»» Specification

Contact material	AgNi / AgSnO alloy	
Contact resistance ⁽¹⁾	100m Ω Max. (1A(100mA for Au-plating contact)/6VDC by 4 pipes m Ω meter)	
Operate time ⁽¹⁾	20ms Max.	
Release time ⁽¹⁾	15ms Max.	
Insulation resistance ⁽¹⁾	1000M Ω Min. (DC 500V)	
Dielectric strength ⁽¹⁾	Between open contact	: AC 2500V , 50/60Hz 1 min. AC 1000V , 50/60Hz 1 min. (for 894N/894HN)
	Between contact circuits	: AC 2500V , 50/60Hz 1 min.
	Between contact and coil	: AC 5000V , 50/60Hz 1 min.
Vibration resistance	Operating extremes	10~55Hz , amplitude 1.5 mm
	Damage limits	10~55Hz , amplitude 1.5 mm
Shock resistance	Operating extremes	10G
	Damage limits	100G
Life expectancy	Mechanical	3,000,000 operations (frequency 18,000 operations/hr)
		300,000 operations (for contact gap 2mm type) (frequency 9,000 operations/hr)
	Electrical	30,000 operations (frequency 360 operations/hr)
Operating ambient temperature	-40~+70°C (no freezing)	
Weight	Approx. 17 g	

Note : (1) Initial value. Operate and release time excluding contact bounce.

»» Safety Approval

Certified	TUV	CSA / CUS	UL / CUL	VDE
File No.	R 50008226	1223057	E88991	40007827

»» Safety Approval Rating

◆UL/CUL · CSA/CUS

894		894H	
C · CA	H · HA	C · CA	H · HA
8A 277VAC 1/4HP 125VAC 1/2HP 250VAC	8A 277VAC 1/4HP 125VAC 1/2HP 250VAC TV-3 (NO)	12A 277VAC 1/3HP 125VAC	12A 277VAC 1/3HP 125VAC 3/4HP 250VAC (NO) TV-5(NO)

◆VDE

894	894N	894H	894HN
8A 250VAC T55	8A 250VAC T70	10A 250VAC T55	10A 250VAC T70

Note : Please contact Song Chuan for the rating details of contact gap 2.0mm.

◆TUV

894	894H
8A 277VAC	12A 250VAC

»» Outline Dimensions

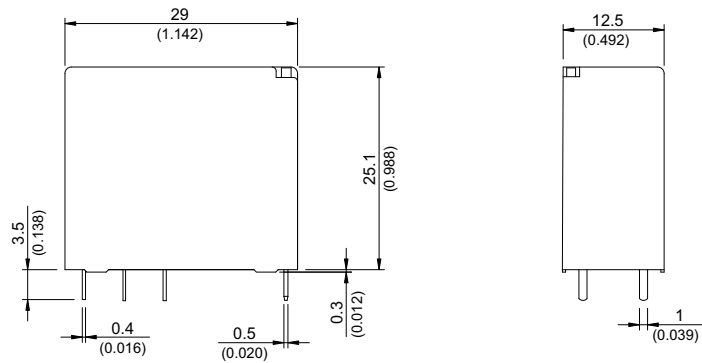

»» Wiring Diagram

BOTTOM VIEW

2C

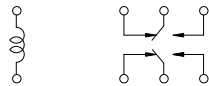

2A

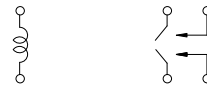

PC Board Layout BOTTOM VIEW

2C

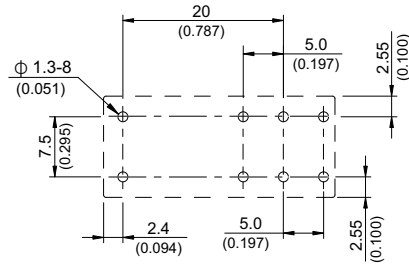

2A

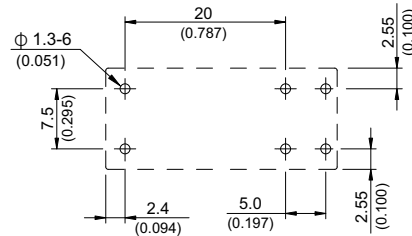

Engineering Data

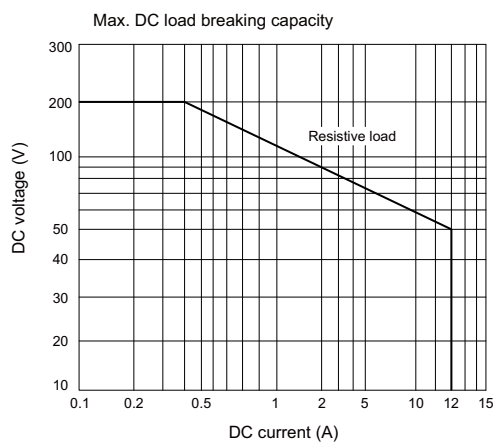
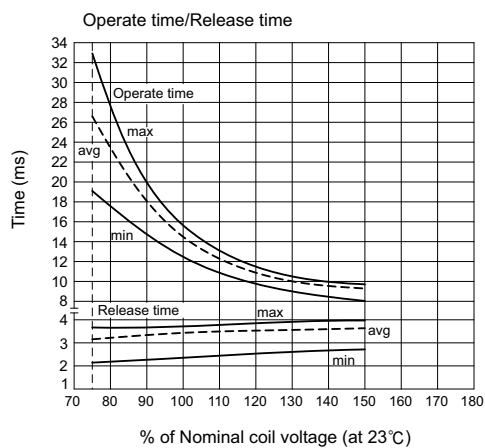
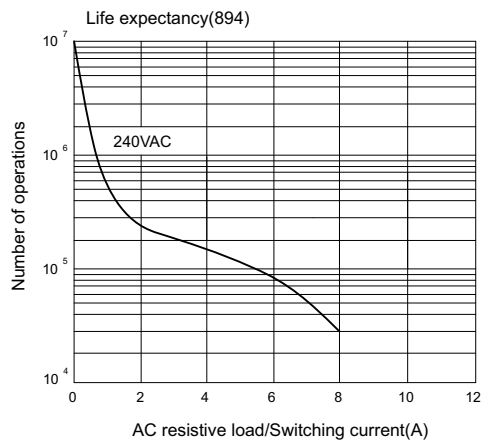
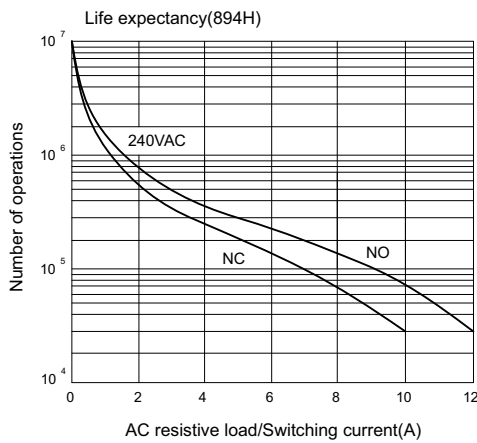
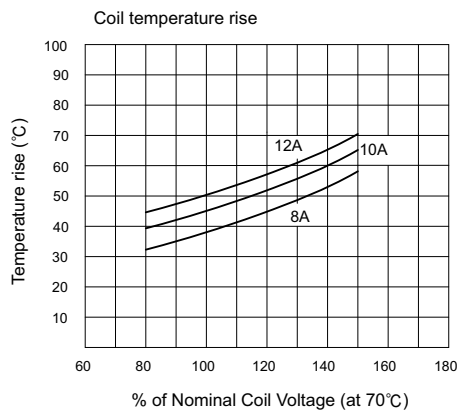
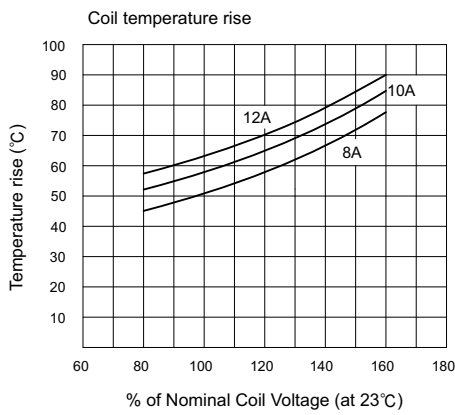

Компания «Океан Электроники» предлагает заключение долгосрочных отношений при поставках импортных электронных компонентов на взаимовыгодных условиях!

Наши преимущества:

- Поставка оригинальных импортных электронных компонентов напрямую с производств Америки, Европы и Азии, а так же с крупнейших складов мира;
- Широкая линейка поставок активных и пассивных импортных электронных компонентов (более 30 млн. наименований);
- Поставка сложных, дефицитных, либо снятых с производства позиций;
- Оперативные сроки поставки под заказ (от 5 рабочих дней);
- Экспресс доставка в любую точку России;
- Помощь Конструкторского Отдела и консультации квалифицированных инженеров;
- Техническая поддержка проекта, помощь в подборе аналогов, поставка прототипов;
- Поставка электронных компонентов под контролем ВП;
- Система менеджмента качества сертифицирована по Международному стандарту ISO 9001;
- При необходимости вся продукция военного и аэрокосмического назначения проходит испытания и сертификацию в лаборатории (по согласованию с заказчиком);
- Поставка специализированных компонентов военного и аэрокосмического уровня качества (Xilinx, Altera, Analog Devices, Intersil, Interpoint, Microsemi, Actel, Aeroflex, Peregrine, VPT, Syfer, Eurofarad, Texas Instruments, MS Kennedy, Miteq, Cobham, E2V, MA-COM, Hittite, Mini-Circuits, General Dynamics и др.);

Компания «Океан Электроники» является официальным дистрибьютором и эксклюзивным представителем в России одного из крупнейших производителей разъемов военного и аэрокосмического назначения «JONHON», а так же официальным дистрибьютором и эксклюзивным представителем в России производителя высокотехнологичных и надежных решений для передачи СВЧ сигналов «FORSTAR».



JONHON

«JONHON» (основан в 1970 г.)

Разъемы специального, военного и аэрокосмического назначения:

(Применяются в военной, авиационной, аэрокосмической, морской, железнодорожной, горно- и нефтедобывающей отраслях промышленности)

«FORSTAR» (основан в 1998 г.)

ВЧ соединители, коаксиальные кабели, кабельные сборки и микроволновые компоненты:

(Применяются в телекоммуникациях гражданского и специального назначения, в средствах связи, РЛС, а так же военной, авиационной и аэрокосмической отраслях промышленности).



Телефон: 8 (812) 309-75-97 (многоканальный)

Факс: 8 (812) 320-03-32

Электронная почта: ocean@oceanchips.ru

Web: <http://oceanchips.ru/>

Адрес: 198099, г. Санкт-Петербург, ул. Калинина, д. 2, корп. 4, лит. А