

SPECIFICATION

- Part No. : **TG.22.0151**
- Product Name : TG22 2G/3G Cellular Connector Mount Monopole Antenna
GPRS-GSM-DCS-PCS-UMTS-CDMA- EDGE-HSPA
824MHz ~2170 MHz
- Features : Ground dependent (Needs mounting to ground-plane)
White Version
3dBi Gain
30%+ Efficiency
Dimensions - 49mm * 8mm
50 Ohms
RP-SMA(M)
Connector customizable
ROHS Compliant



1. Introduction

The TG.22.0151 2G/3G monopole helical antenna operates from 824MHz to 2170MHz on GSM-DCS-PCS-UMTS-CDMA-GPRS-EDGE-HSPA. Once mounted to an adequate ground-plane it is a compact robust terminal antenna with high gain and stable efficiency in a small form factor. Connection is made via straight RP-SMA(M) connector.

Typical applications

- Remote monitoring

At only 49mm in height, with a hardened TPEE casing, this antenna is the ideal GPRS/UMTS antenna for telematics devices where larger antennas cannot be used.

Like all small monopole antennas, it must be mounted on a ground-plane to radiate efficiently. The antenna should be mounted at the edge of the ground-plane of the mainboard of the device. See below charts for analysis of performance. A larger ground-plane of more than 100mm is needed for stable performance on all bands. Also no metal should be used near the antenna, with at least 20mm of clearance required, the more clearance the better.

For devices with ground-planes smaller than 100mm in length or where metal clearance is not adequate, alternative larger antennas should be considered such as the TG.30. If small size is needed, a custom tuned solution or a new design may also be necessary. Contact your Taoglas regional sales office for support.

2. Electrical Specification

Parameter	Specification				
Bands	GSM850	GSM900	DCS	PCS	WCDMA I
Frequency Range	824~896MHz	880~960MHz	1710~1880MHz	1850~1990MHz	1920~2170MHz
Return Loss	≤-5dB				
VSWR	≤3.5				
Peak Gain	1.42dBi	1.91dBi	2.51dBi	3.23dBi	2.89dBi
Efficiency	64.40%	68.29%	70.67%	72.61%	68.48%
Average Gain	-1.92dBi	-1.66dBi	-1.51dBi	-1.39dBi	-1.67dBi
Polarization	Linear				
Power handling	20 W				
Impedance	50 Ohms				
Connector	Straight RP-SMA(M)				

*All the antenna characteristics were measured with 150mm*90mm ground plane

Environmental & Mechanical Characteristics

Parameter	Specification
Temperature	-40°C to +85°C
Radome color	Black
Radome material	TPEE
Weight	6 g

3. TEST SET UP

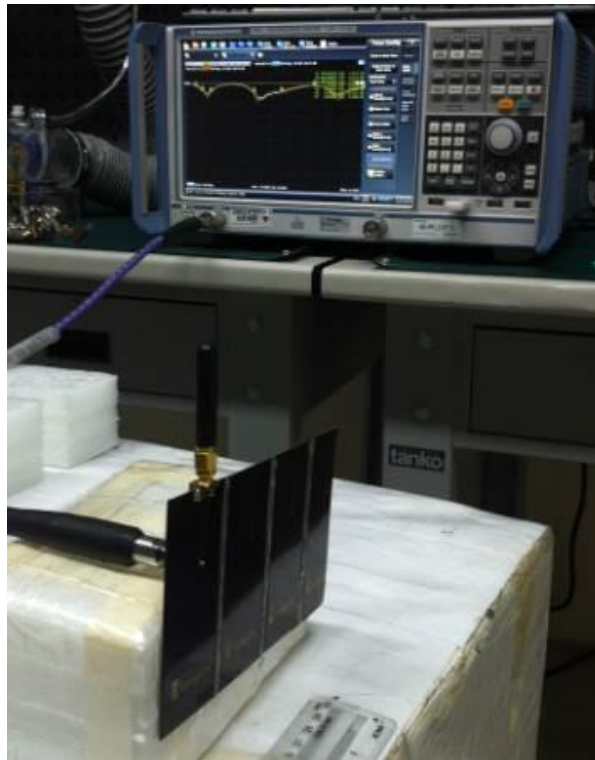

Figure 1. Impedance and VSWR measurements

4. ANTENNA PARAMETERS

4.1. Return Loss

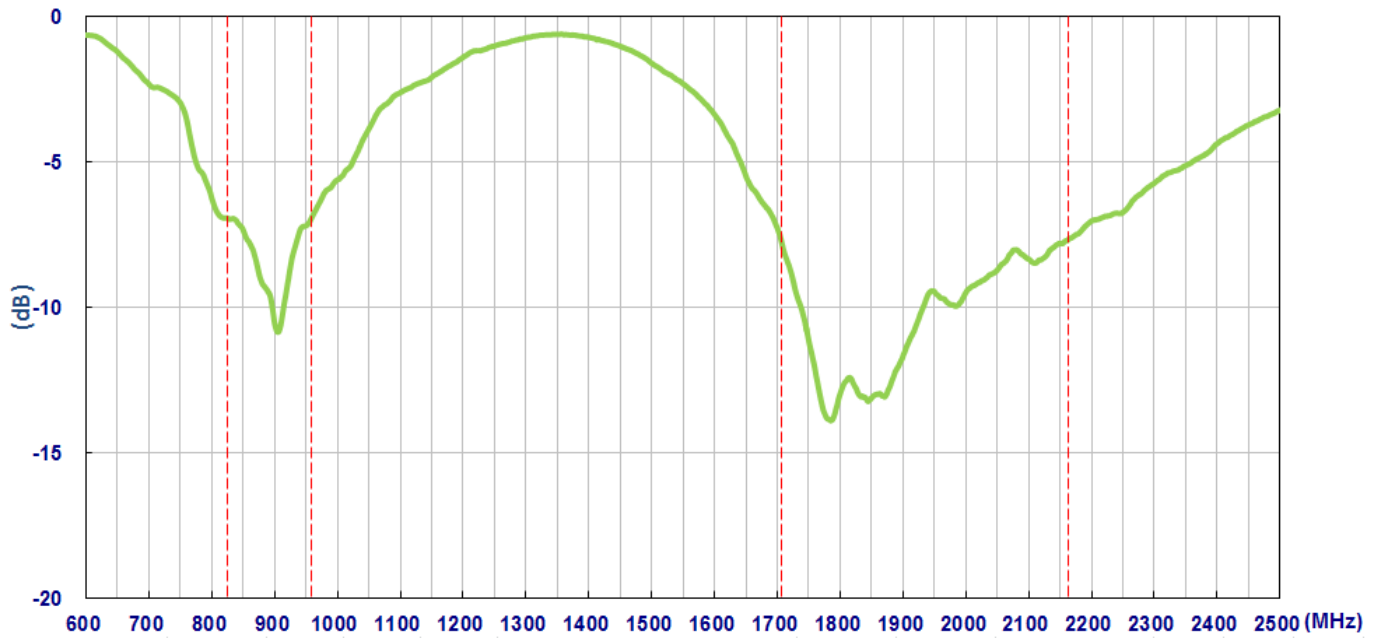

Figure 2. Return Loss of TG.22.0151

4.2. VSWR

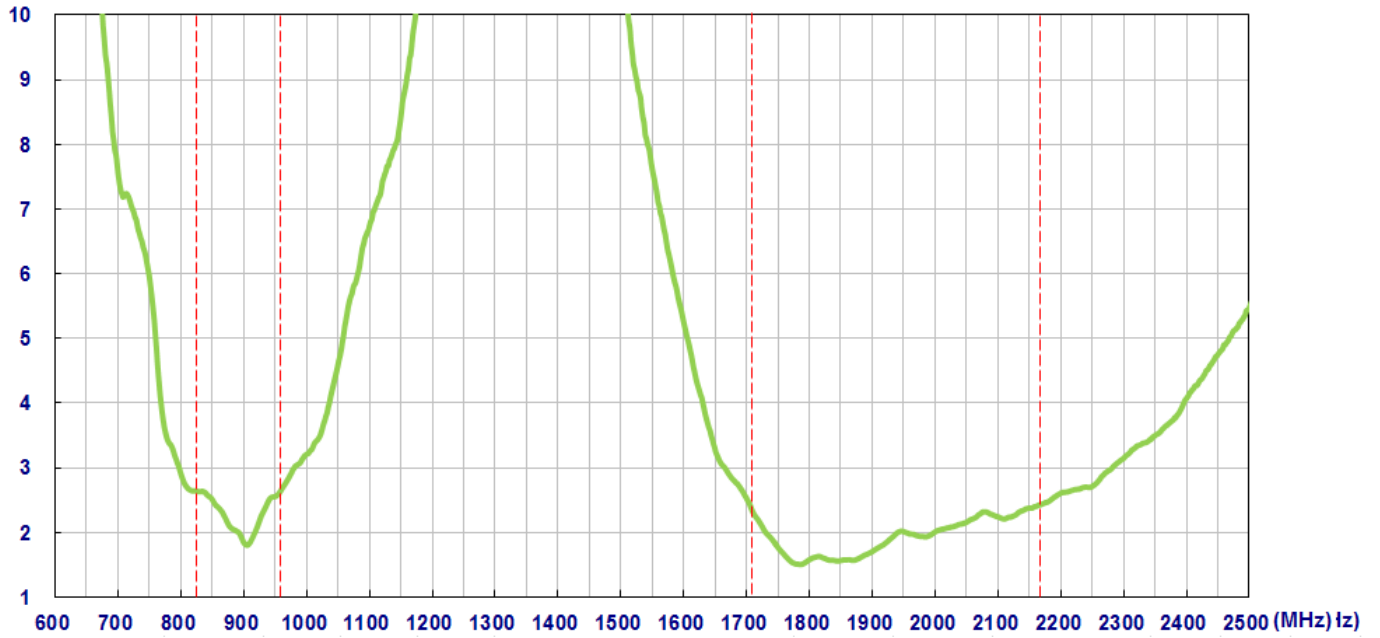

Figure 3. VSWR of TG.22.0151

4.3 Efficiency (%)

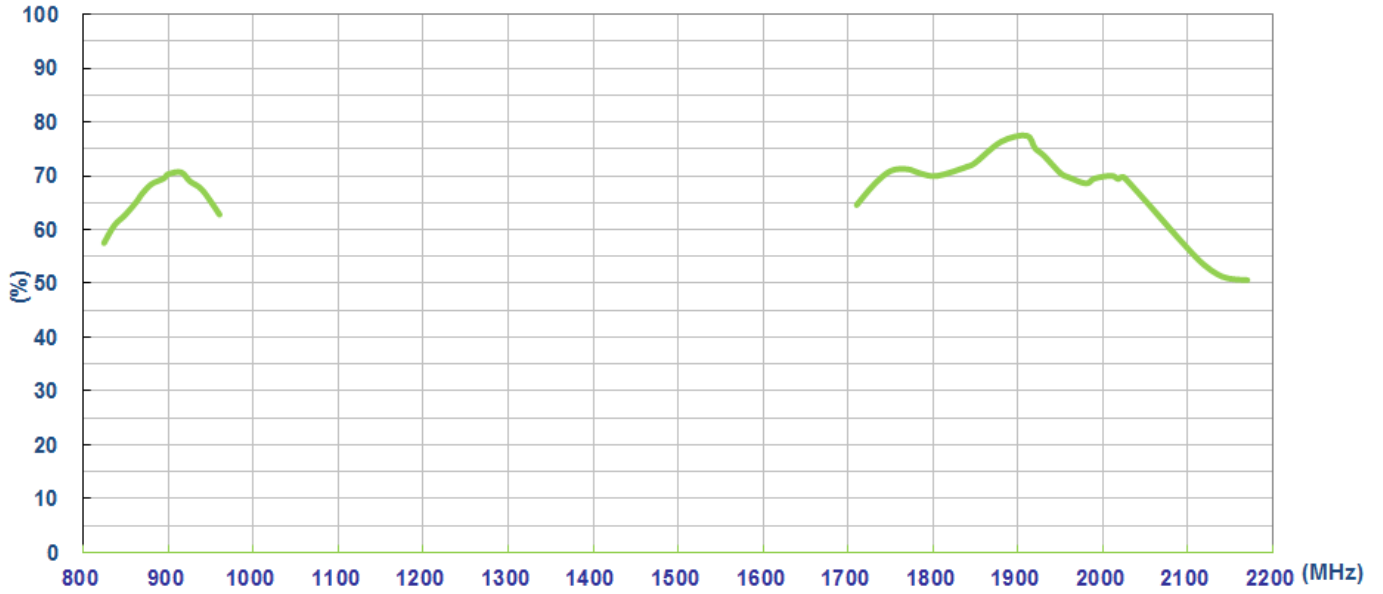

Figure 4. Efficiency of TG.22.0151

4.4 Peak Gain(dBi)

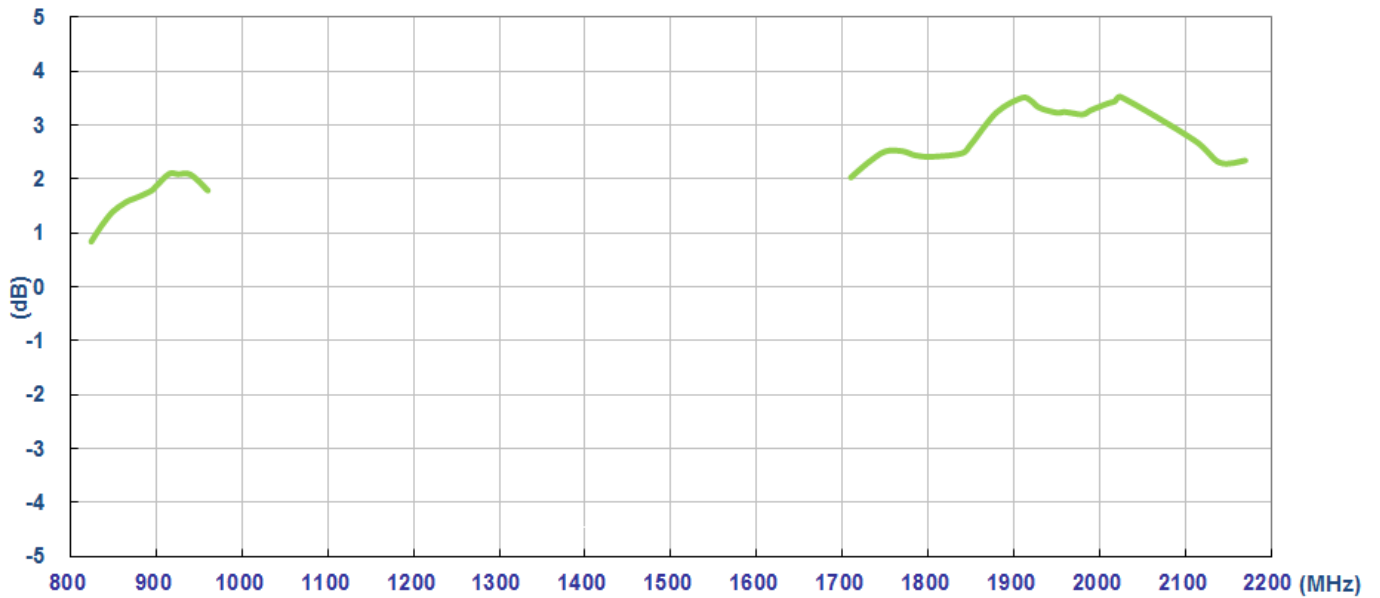

Figure 5. Peak Gain of TG.22.0151

4.5 Average Gain(dBi)

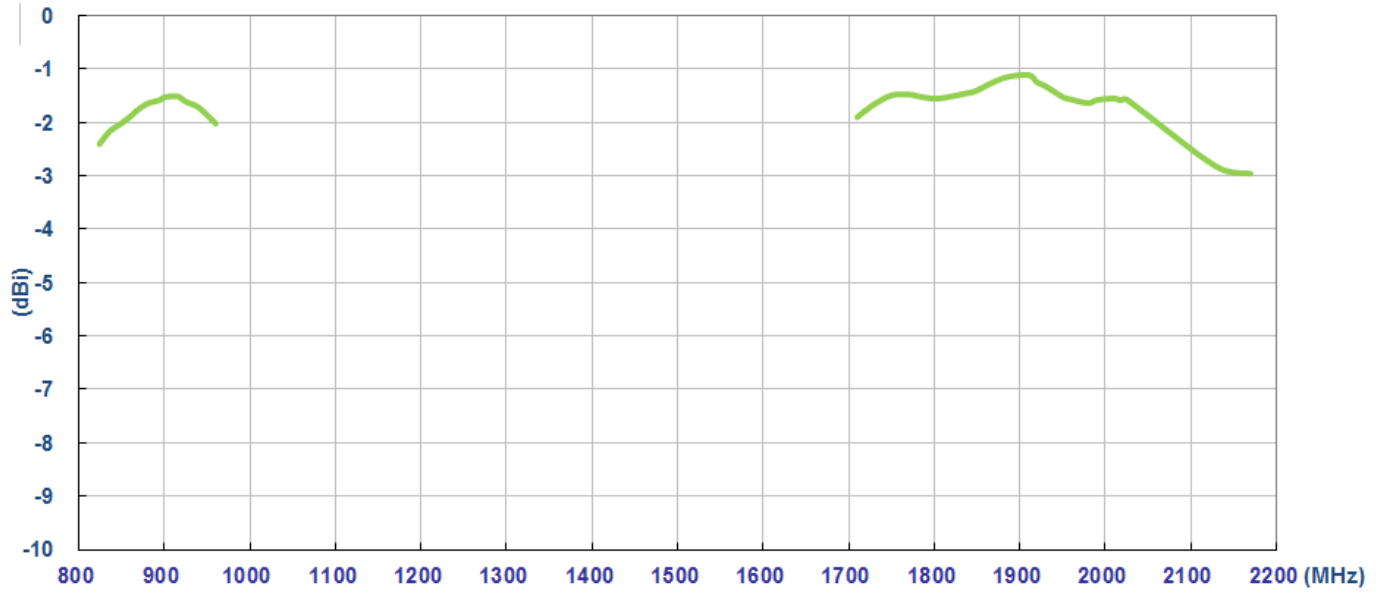
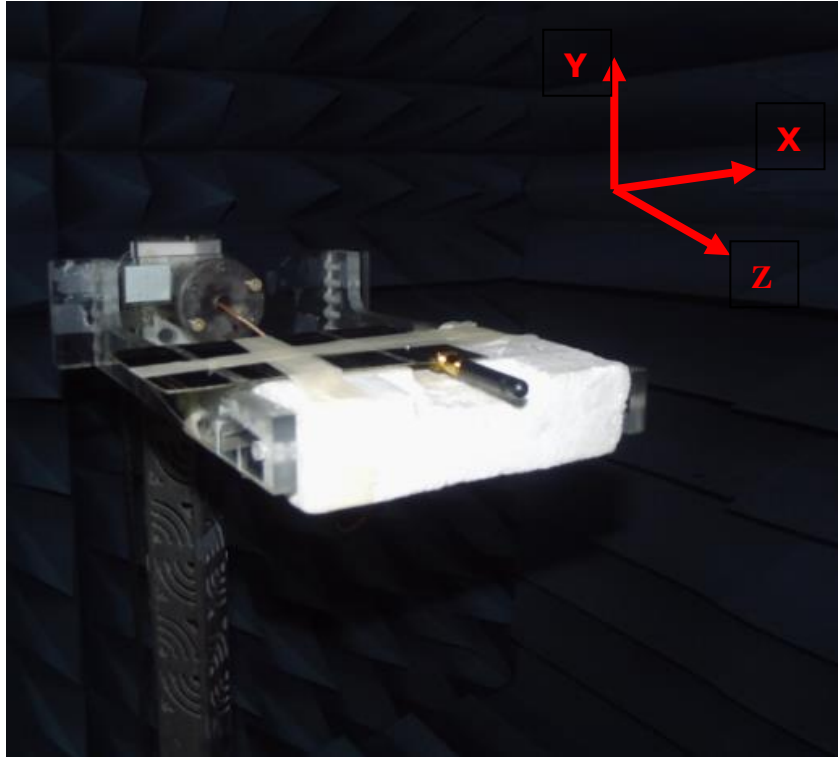

Figure 6. Average Gain of TG.22.0151

4.6 Radiation Pattern Data



4.6.1 Radiation Pattern

XY Plane

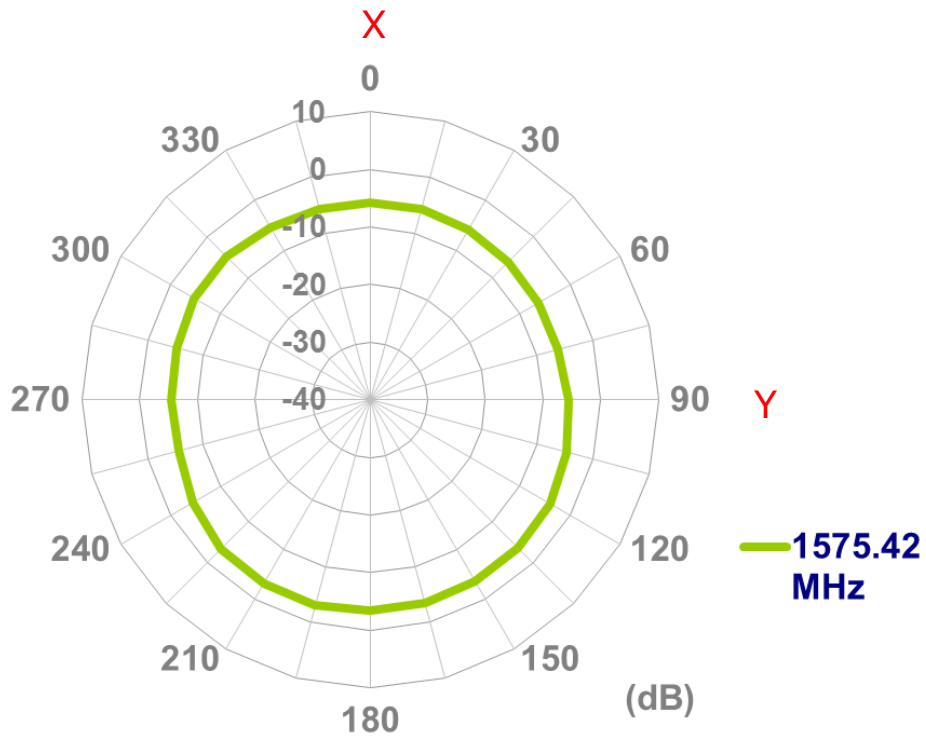
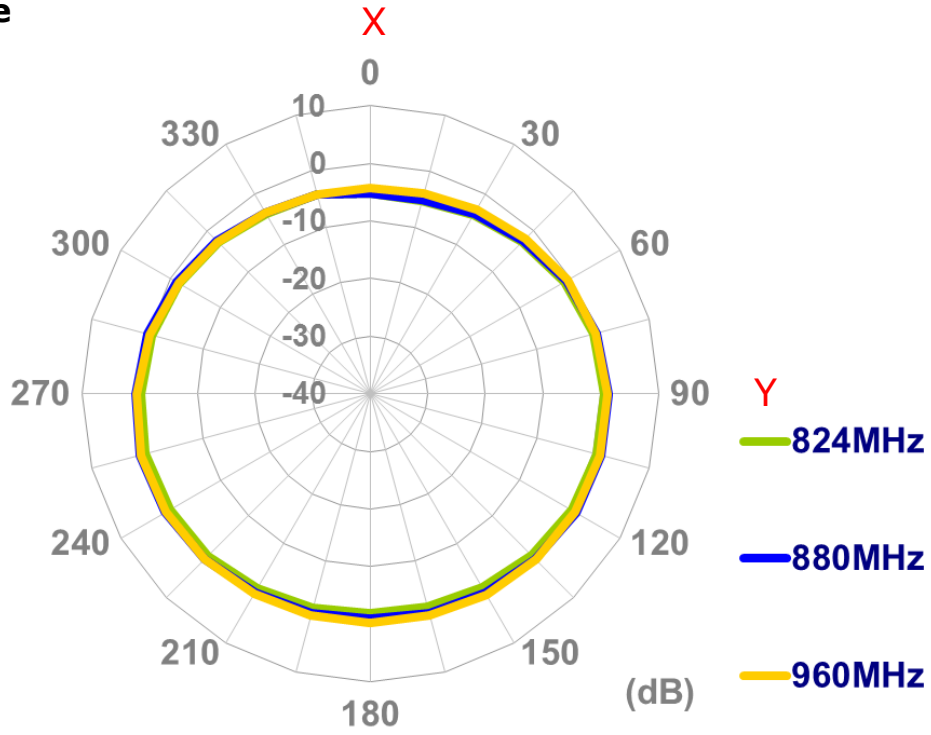

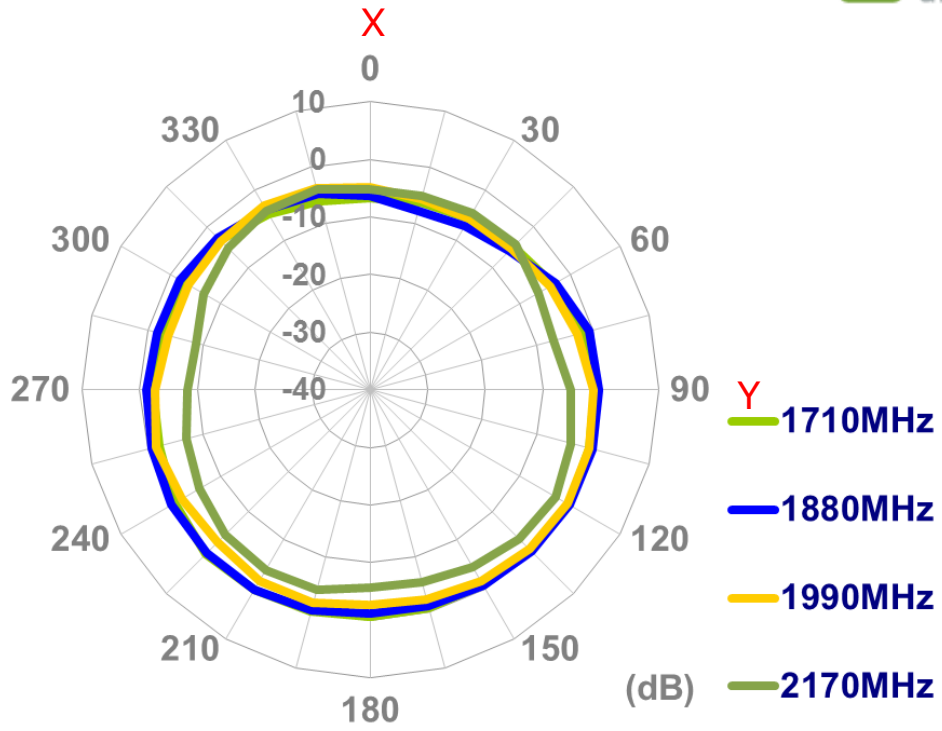

XZ Plane

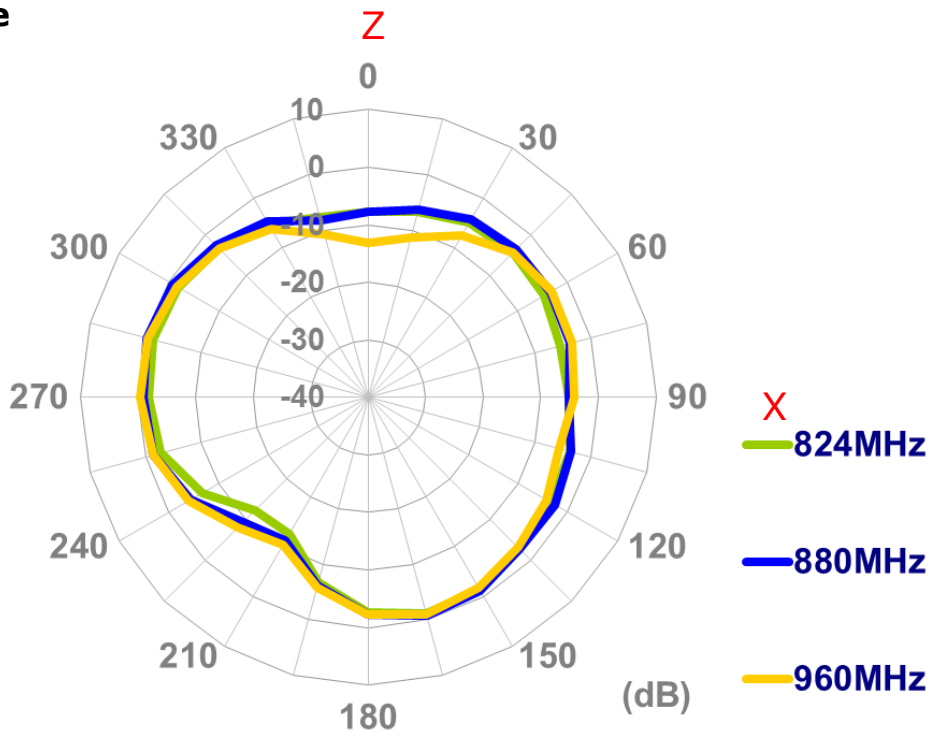

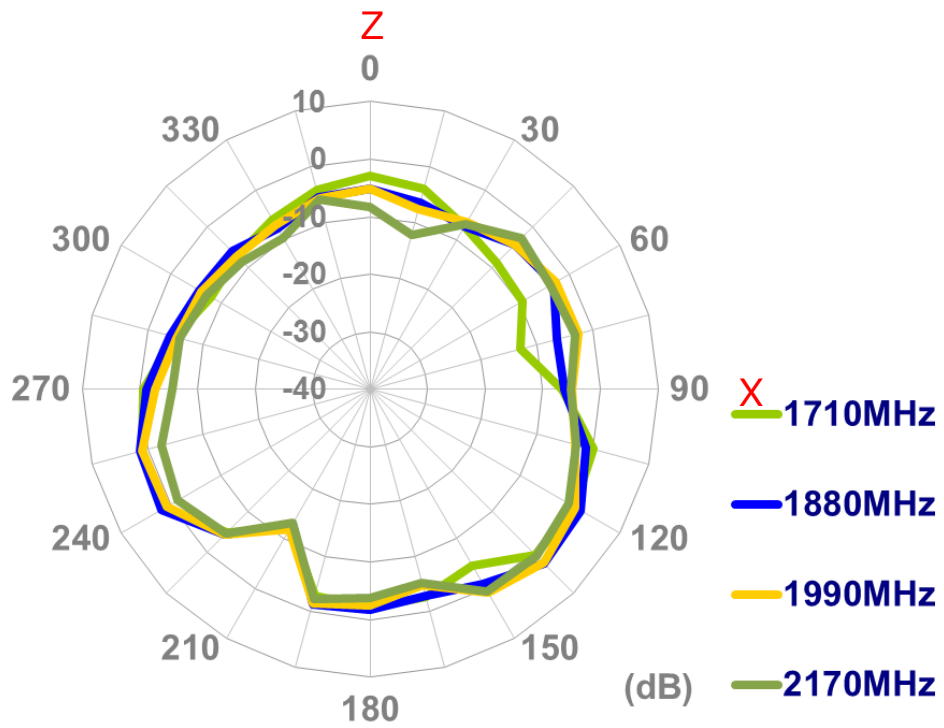
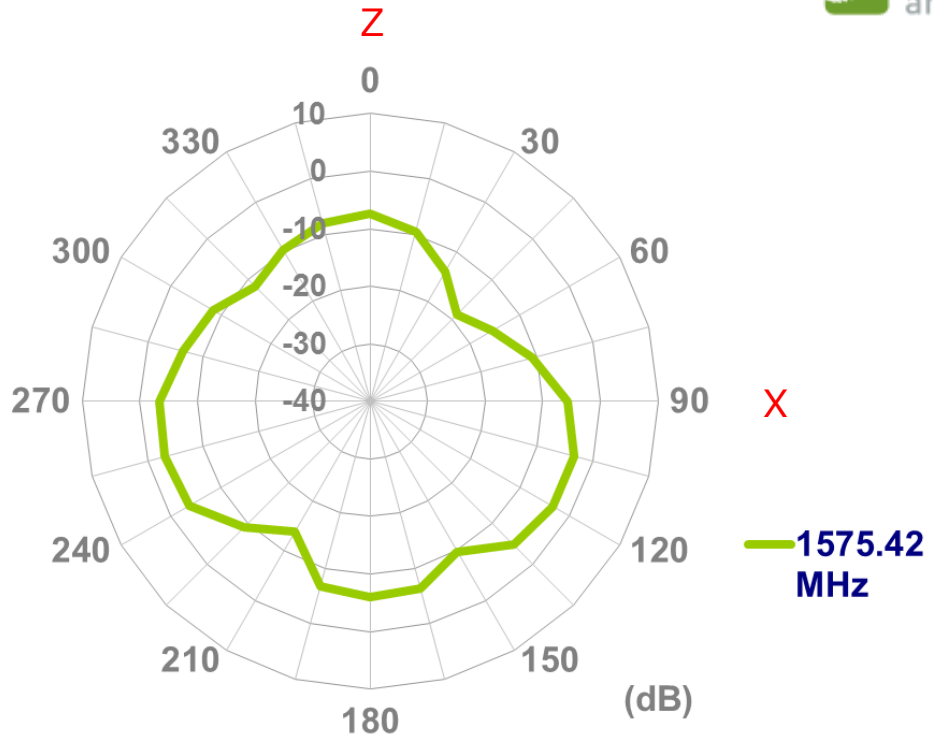

YZ Plane

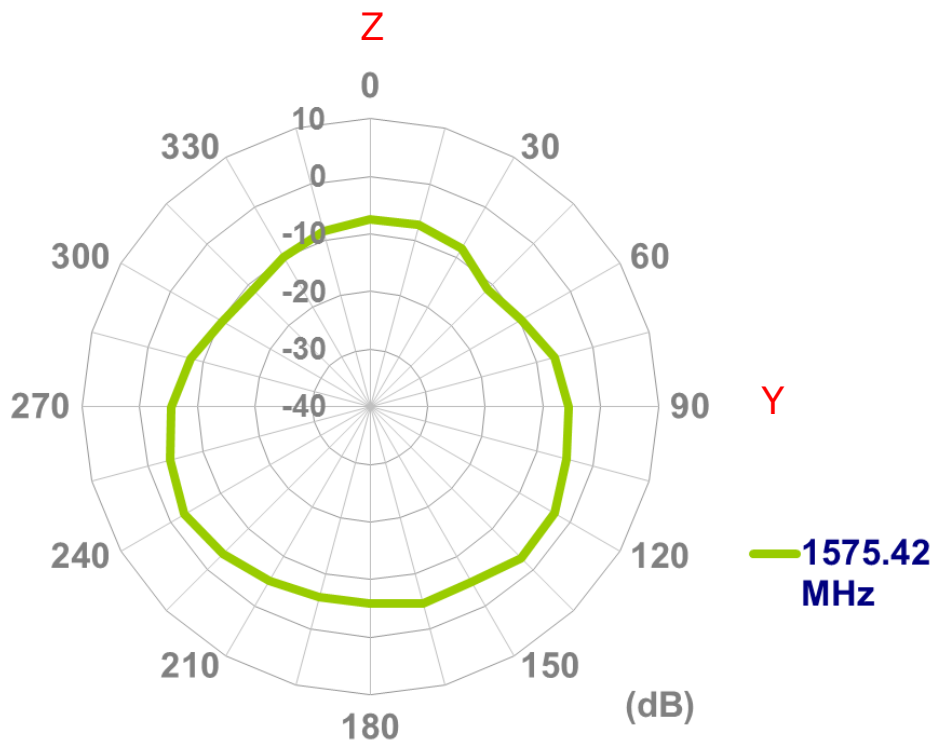
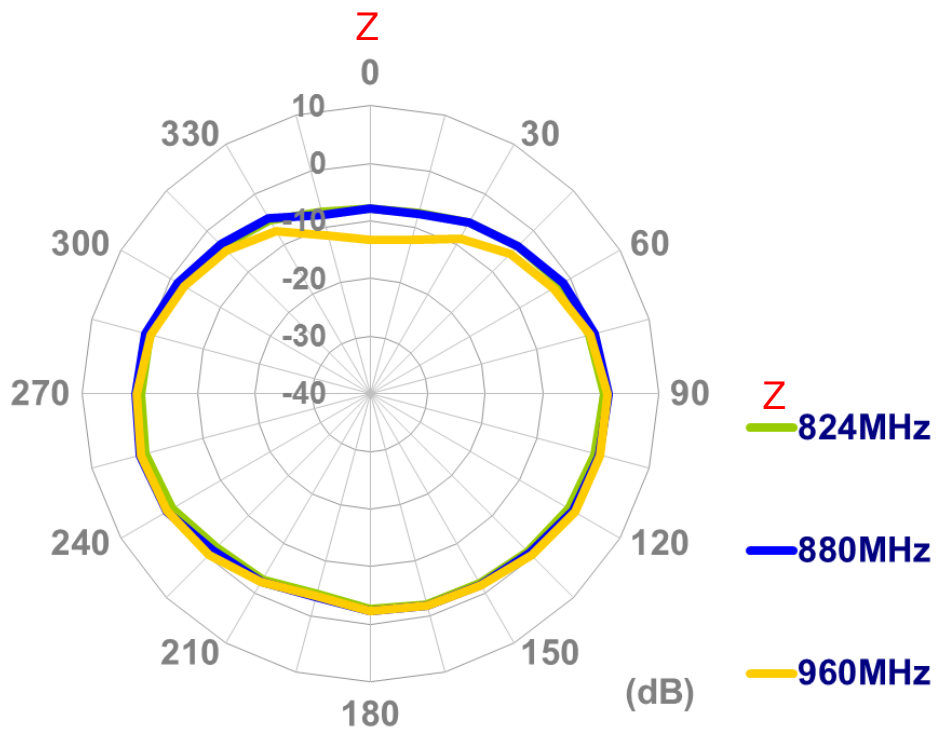

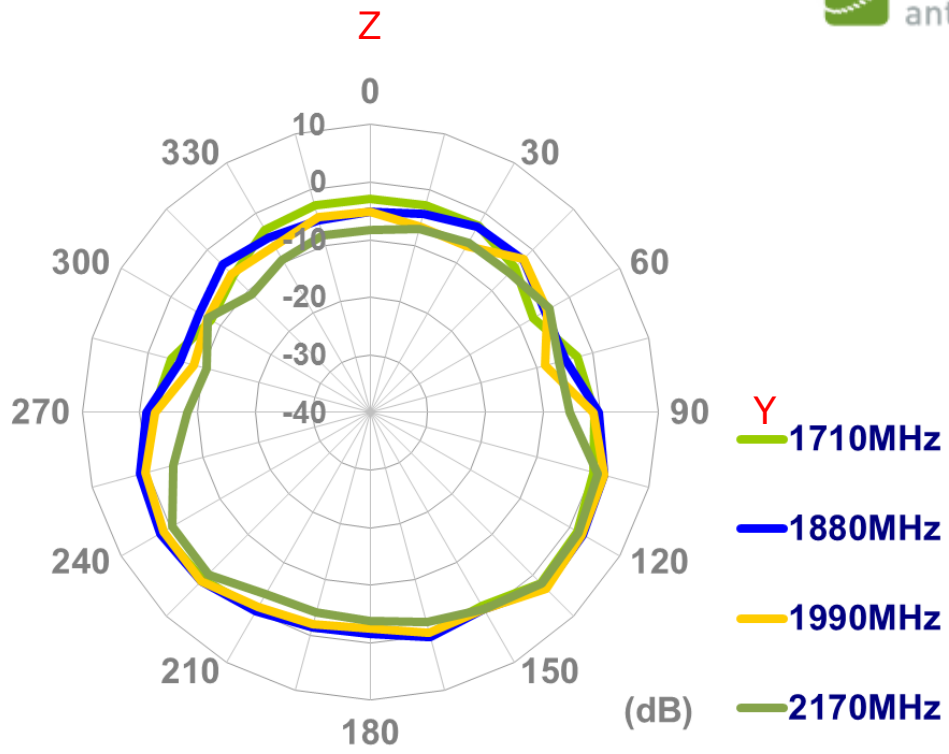

4. Drawing and Dimensions (unit: mm)

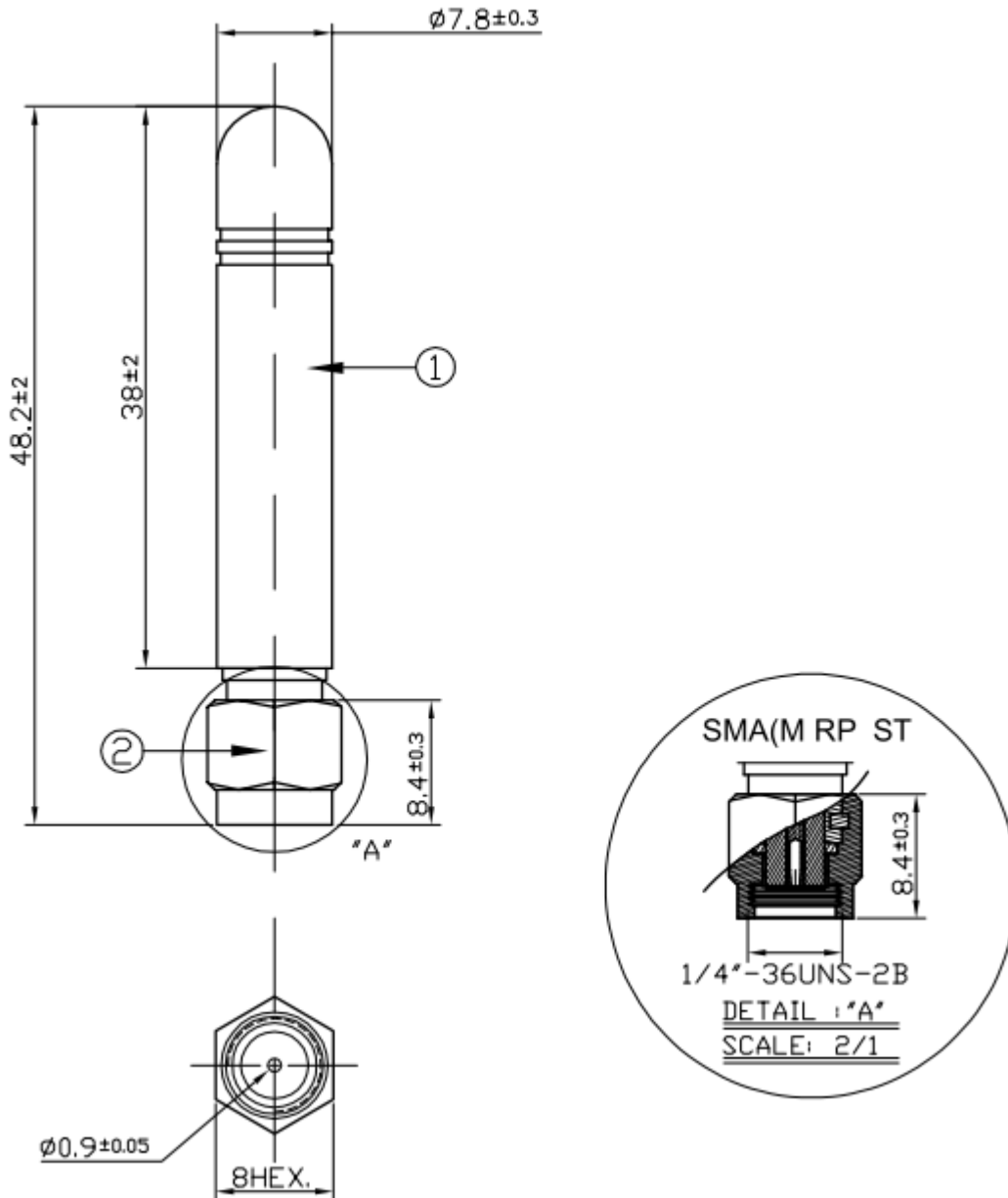

	Name	P/N	Material	Finish	Quantity
1	Antenna Housing	000111F0300XXA	TPEE	Black	1
2	RP-SMA(M) ST	200211J000002A	Brass	Gold	1

6. Packaging

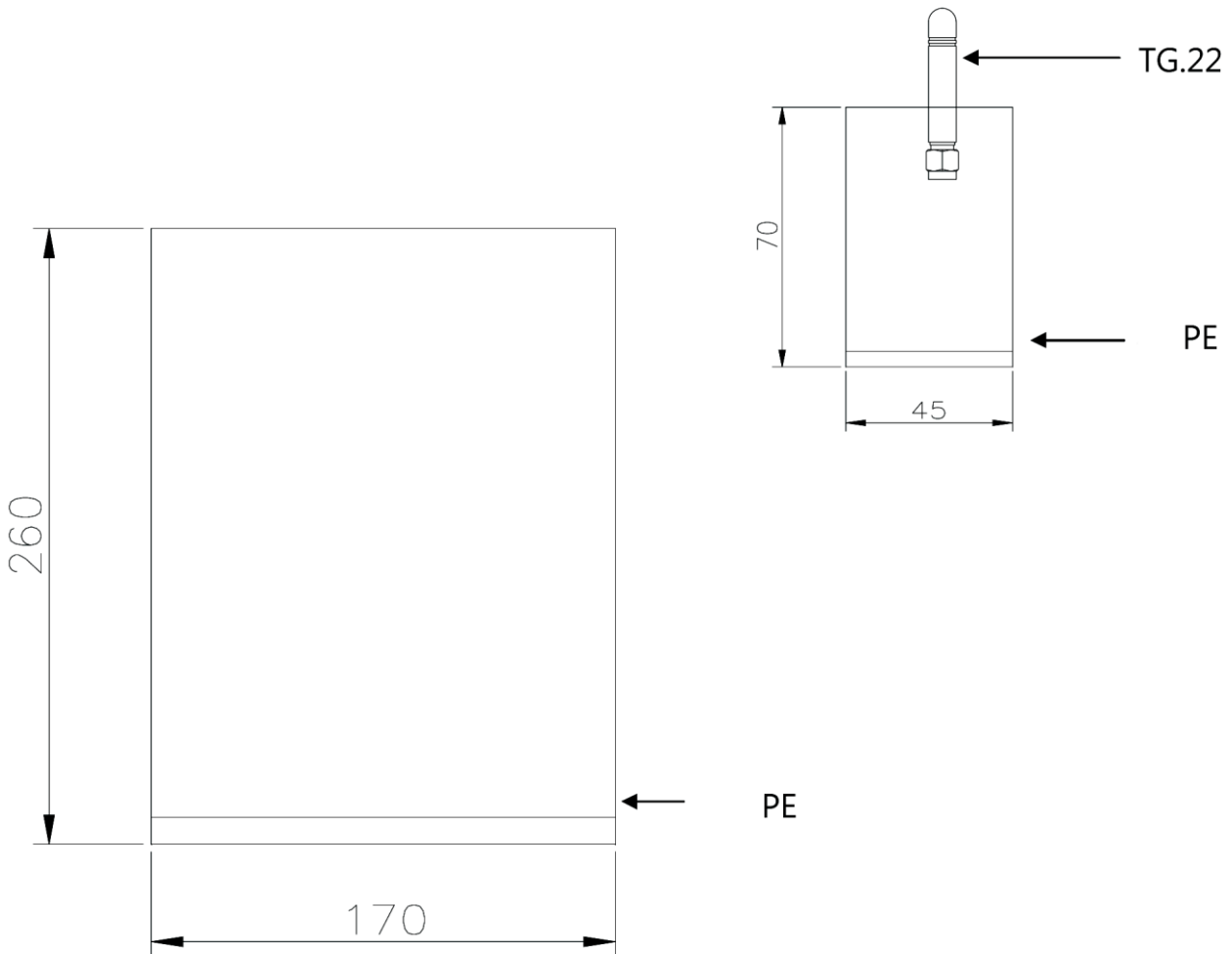

1pcs antennas per small PE bag.

100 small PE bags per big PE bag.

100pcs antennas per big sealed PE bag.

7. Installation

- 1) Use hand to screw the SMA connector.
Tighten it until it feels a little tight.



- 2) Use torque wrench which has 0.9 Nm torque limit to tighten it.



- 3) Do not use normal wrench.



8. Application Note

This section, Taoglas provides the ground variation effects to TG.22.0151 antenna. Detail setup is setup as below.

8.1 Ground Plane Dimensions:

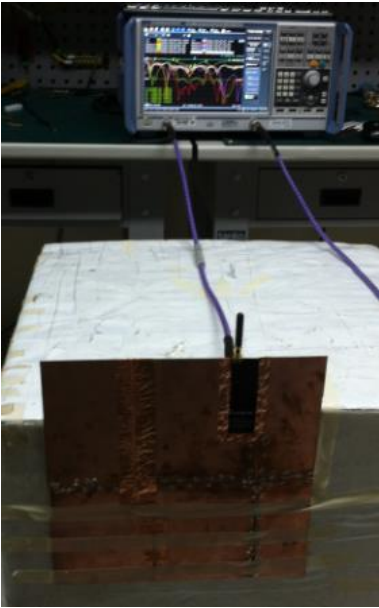

30cm*30cm



20cm*20cm

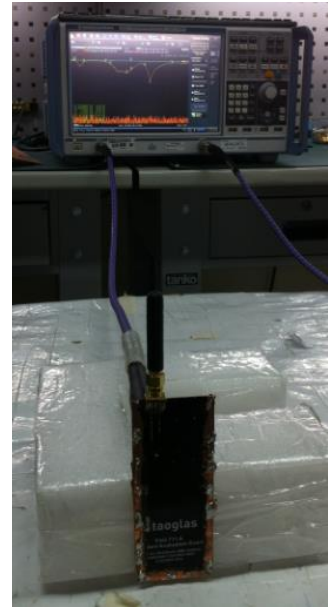

10cm*4cm

8.2 Return Loss:

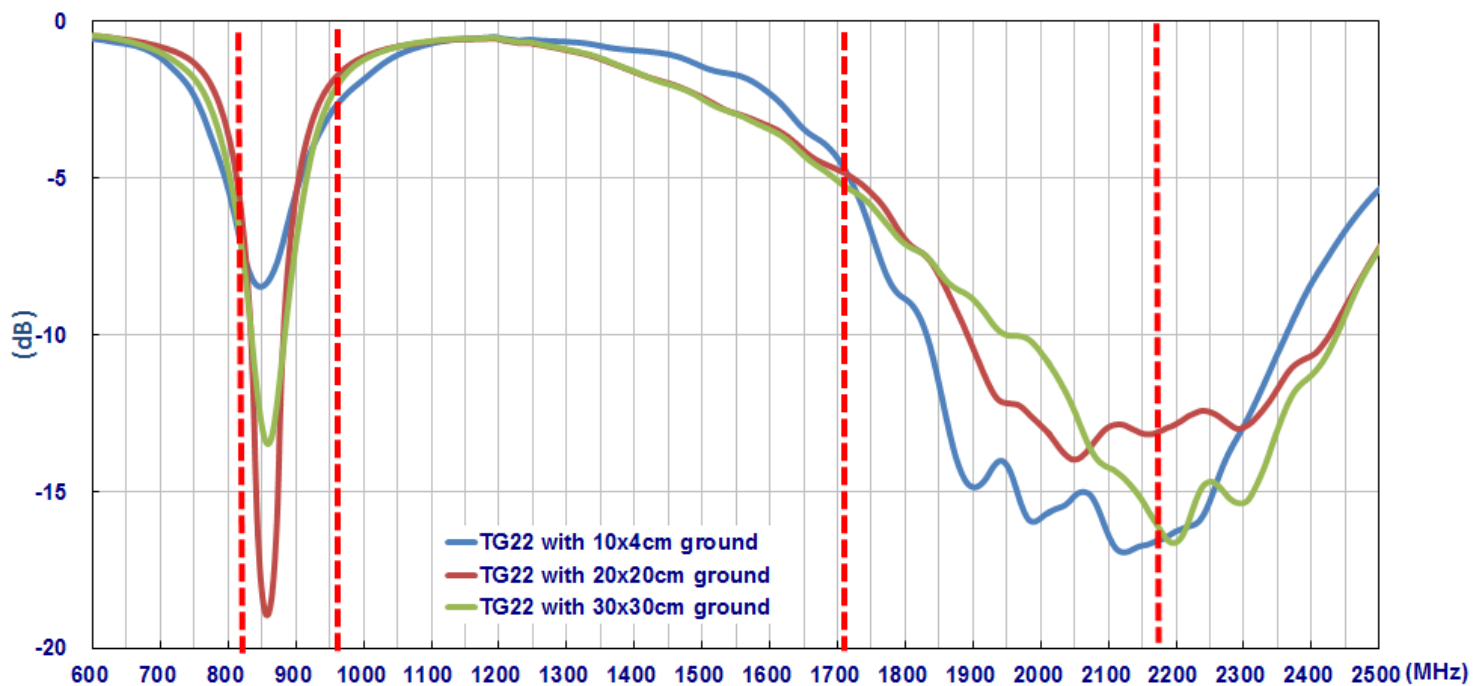

8.3 Efficiency:

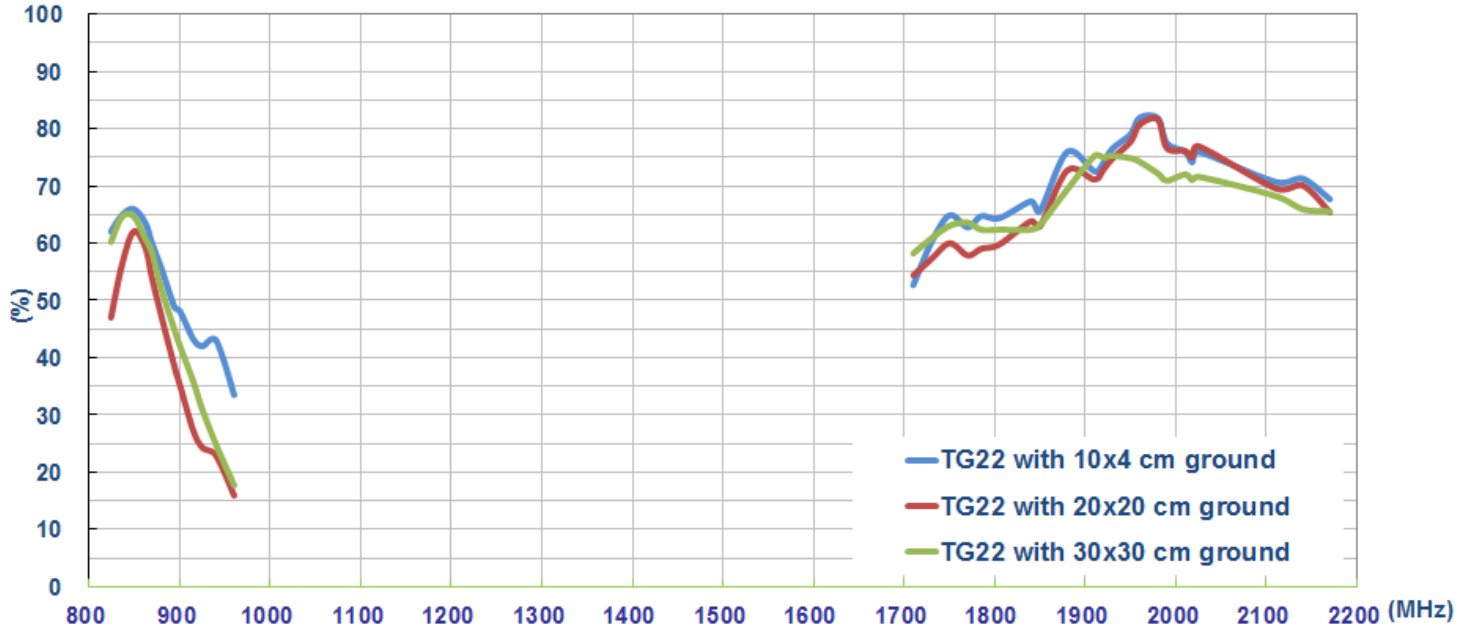

8.4 Peak Gain:

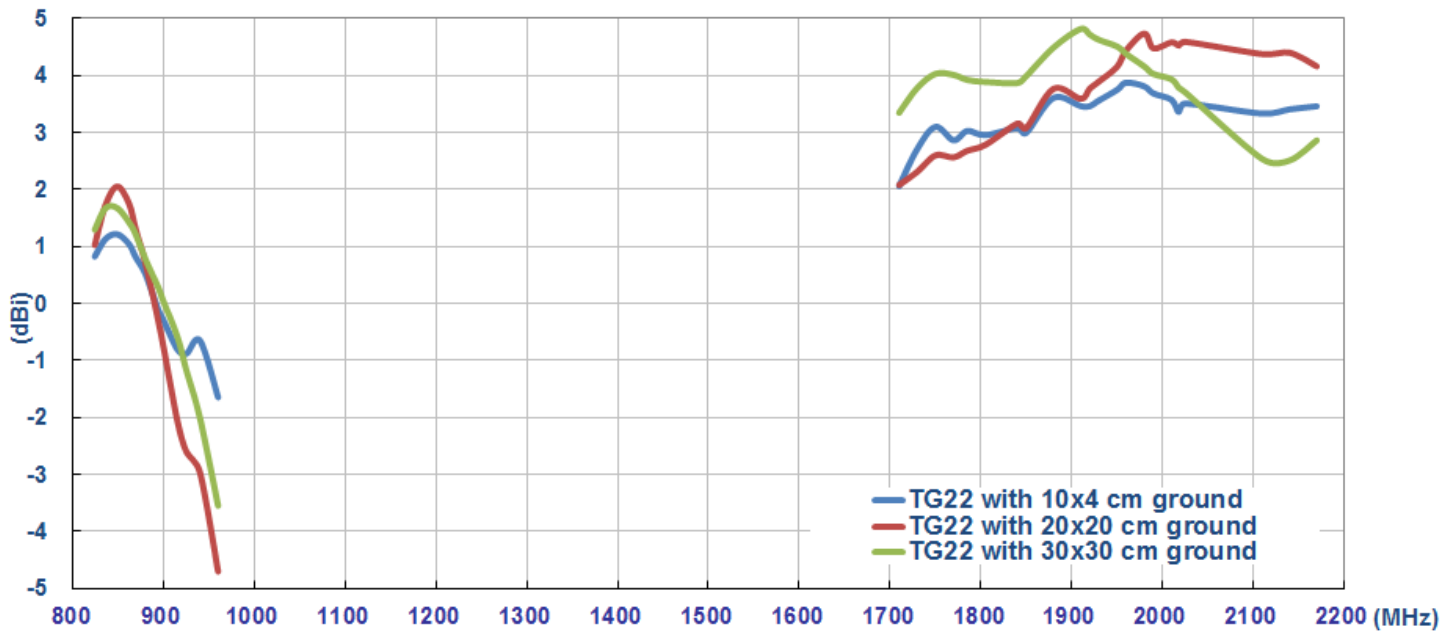

8.5 Radiation Pattern Measurement Setup:

8.5.1 30cm*30cm Ground Plane

Setup

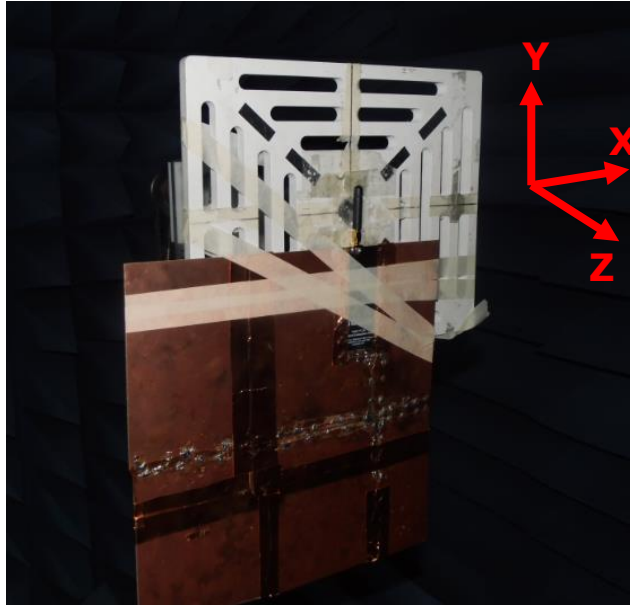

XY Plane

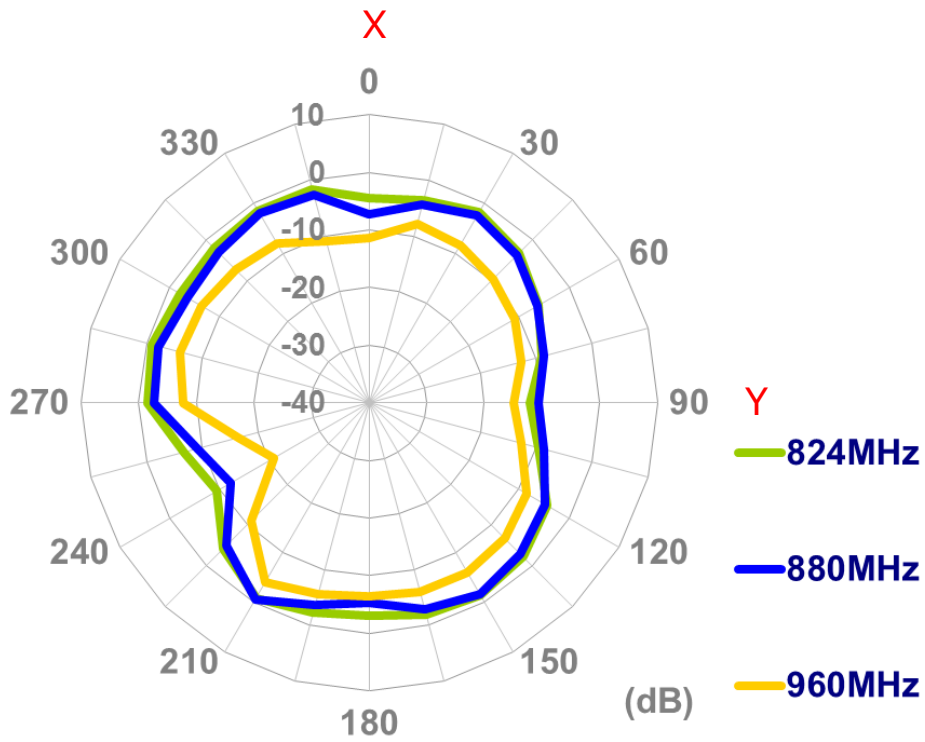

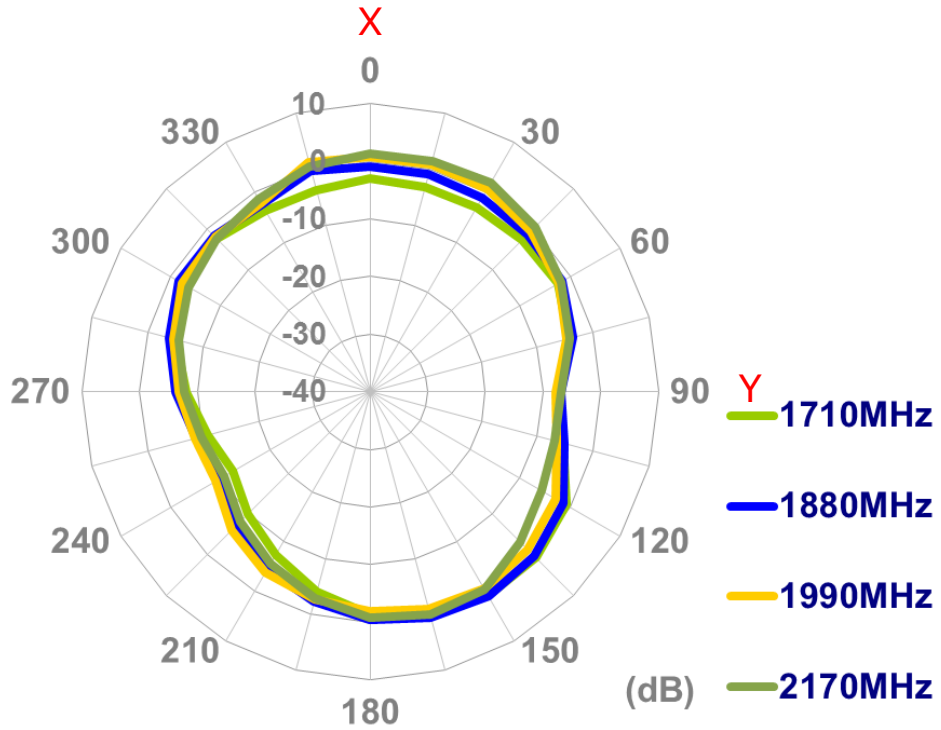
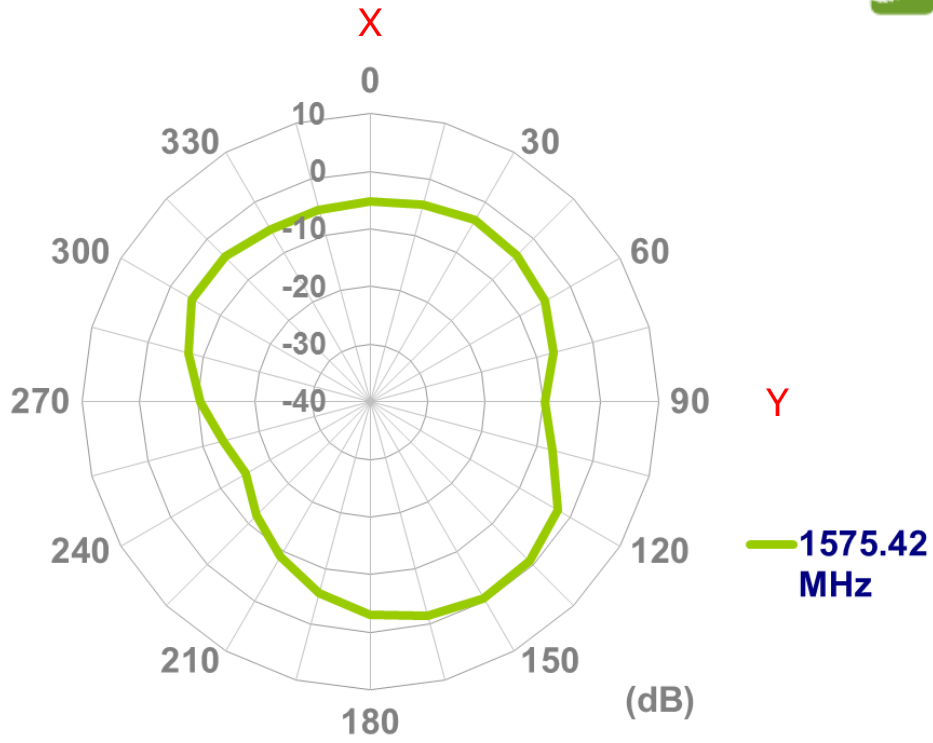

XZ Plane

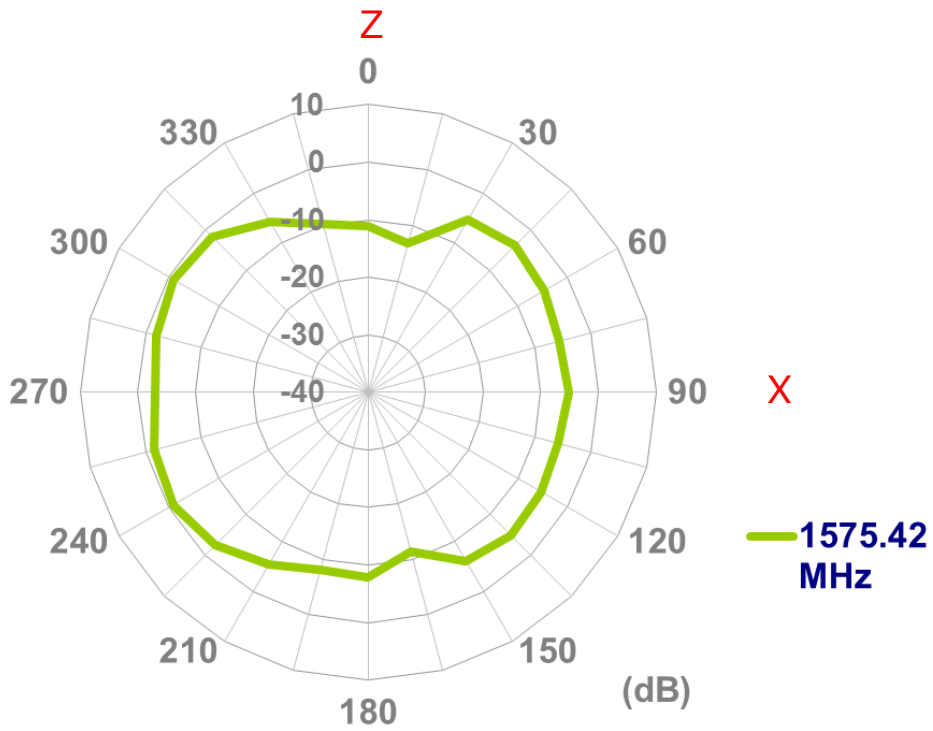
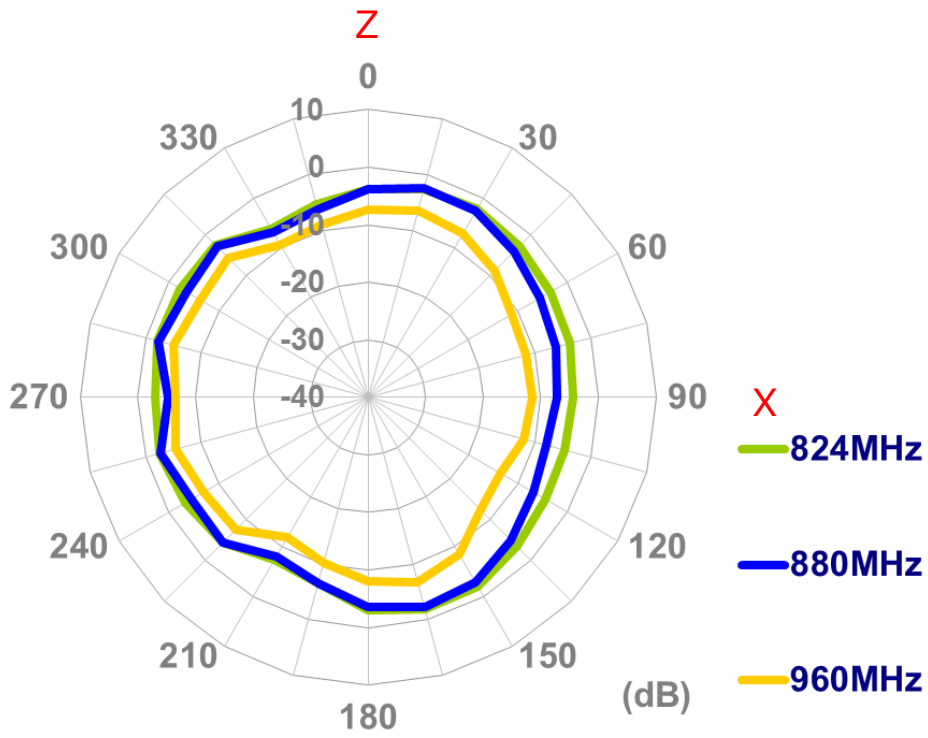

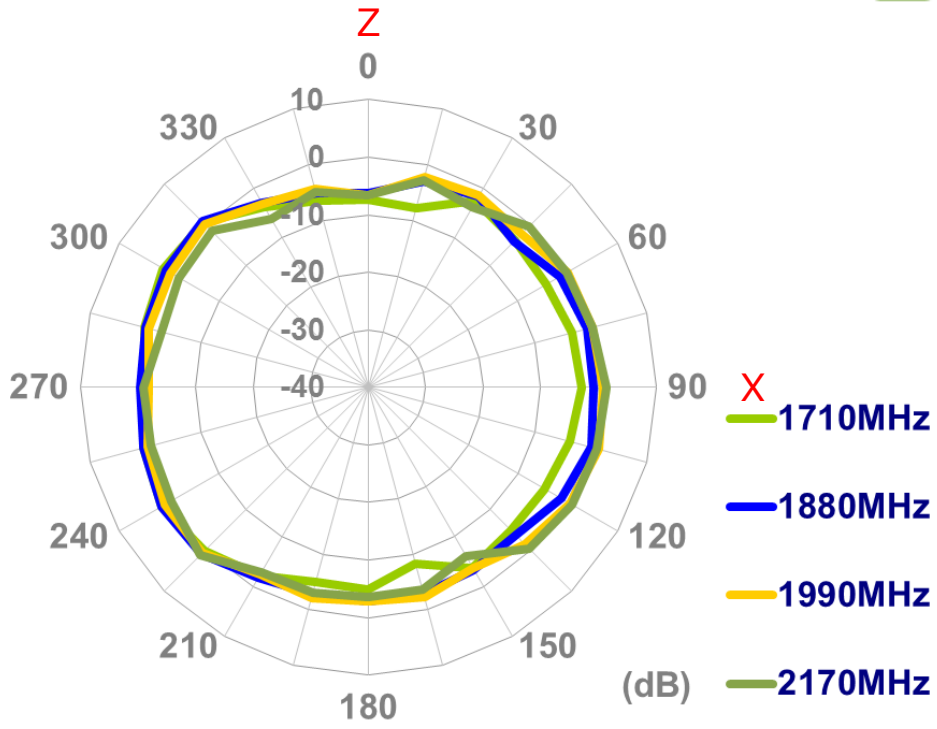

YZ Plane

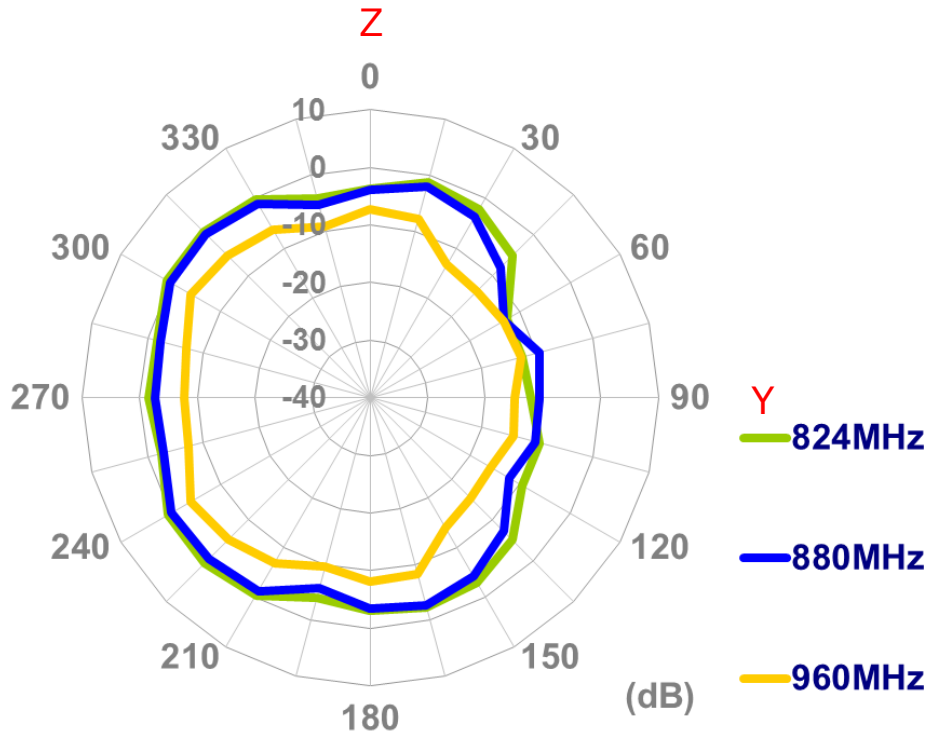

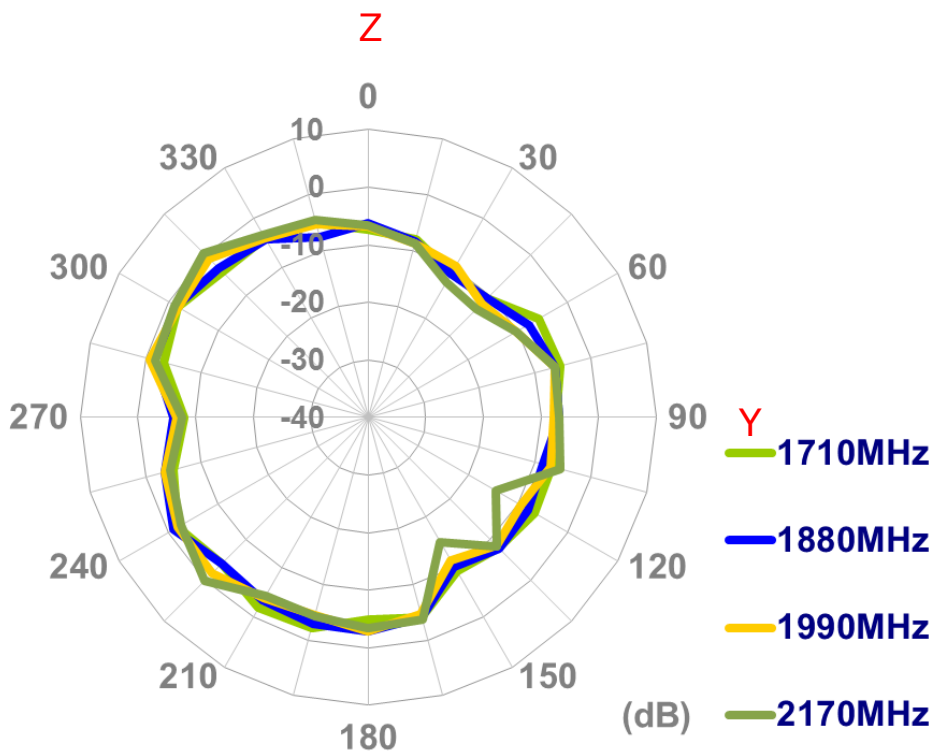
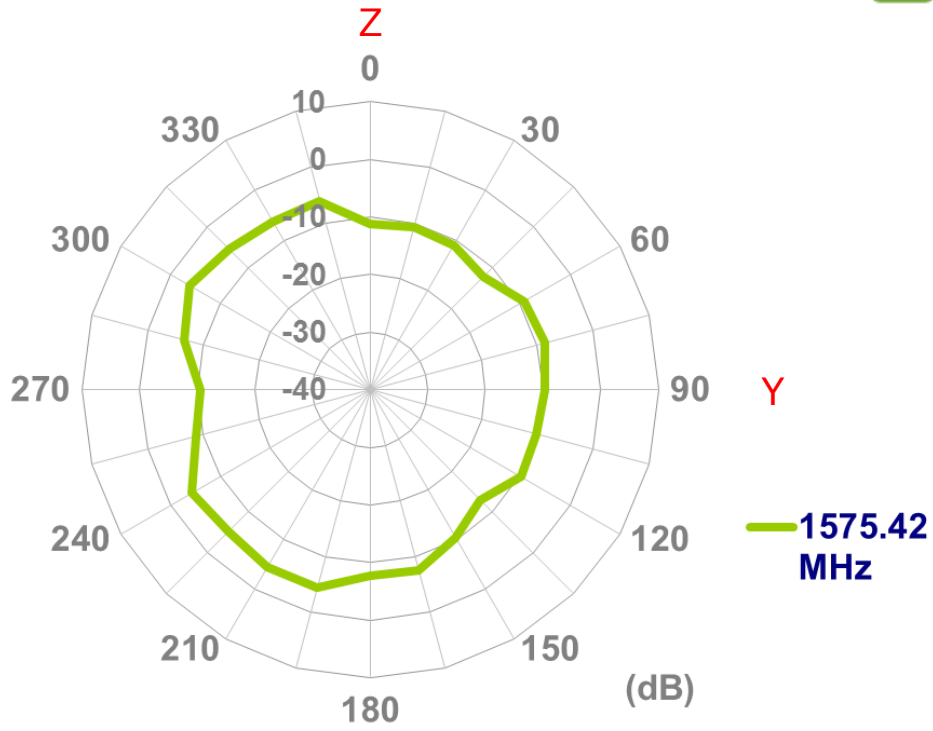

8.5.2 20cm*20cm Ground Plane

Setup

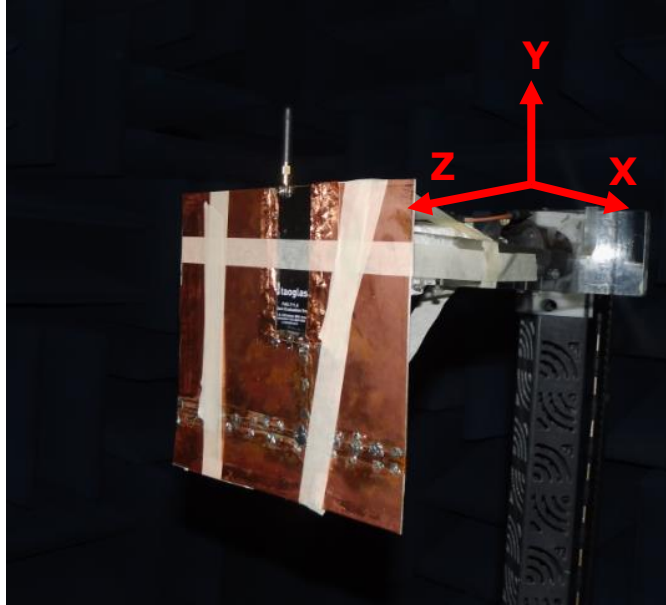

XY Plane

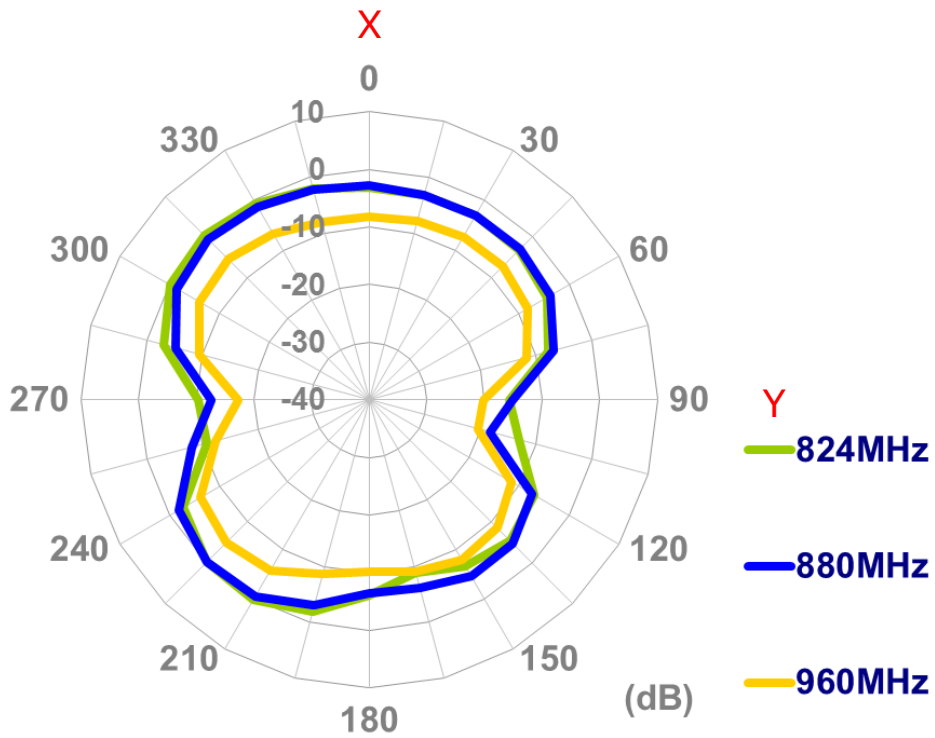

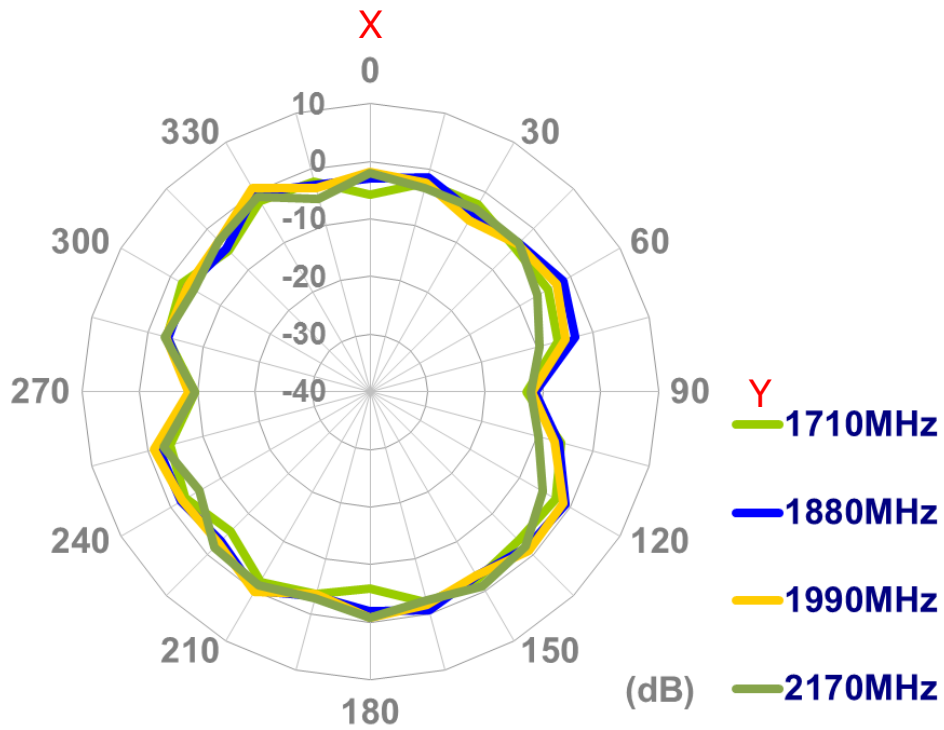
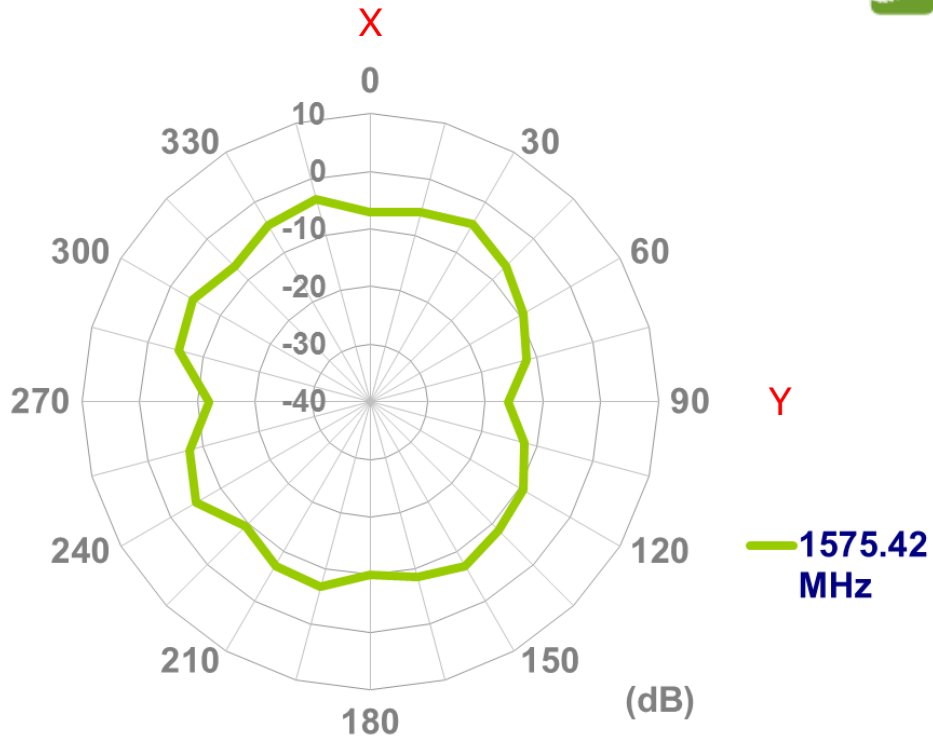

XZ Plane

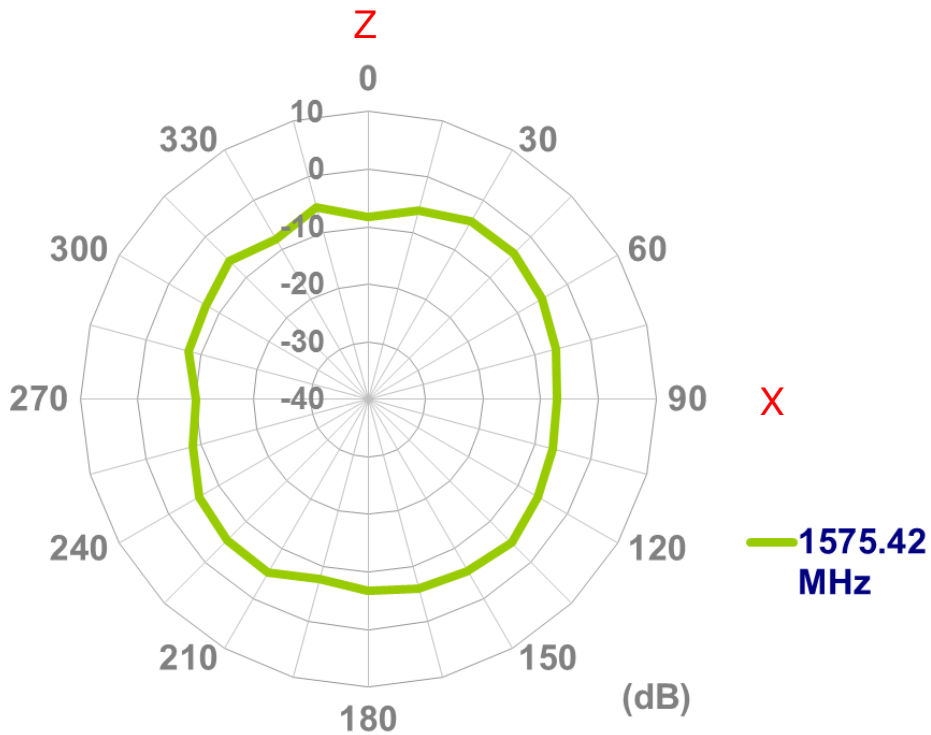
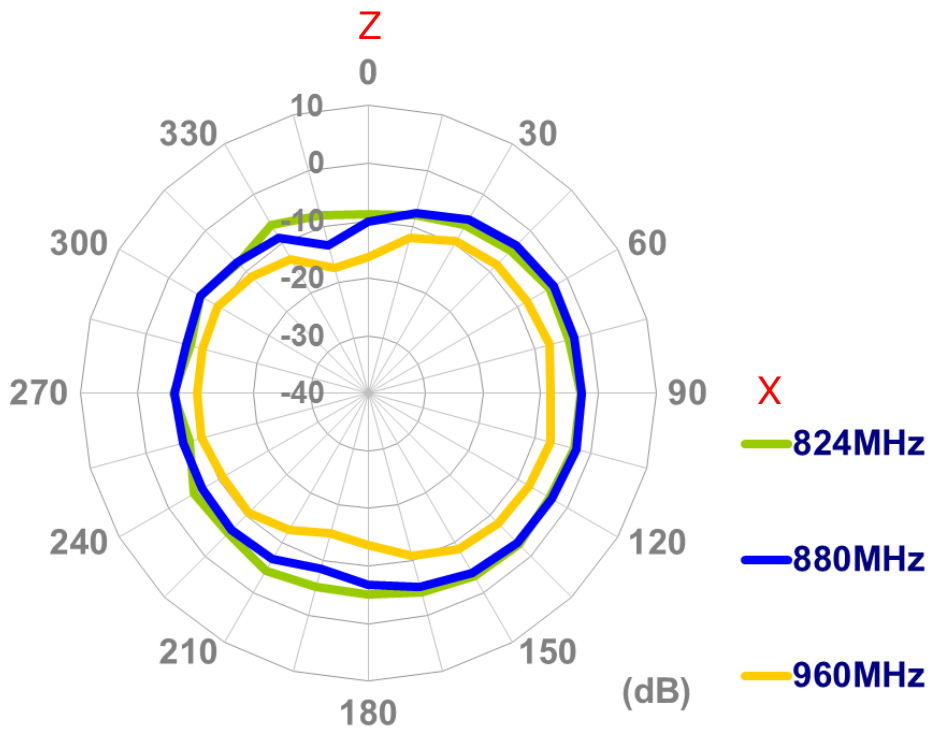

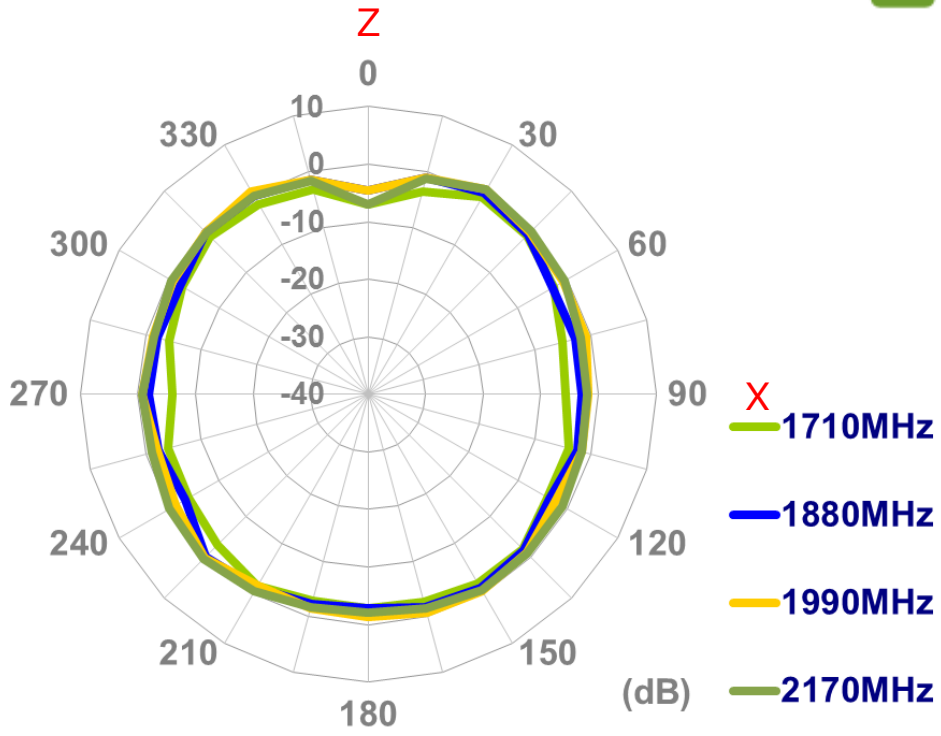

YZ Plane

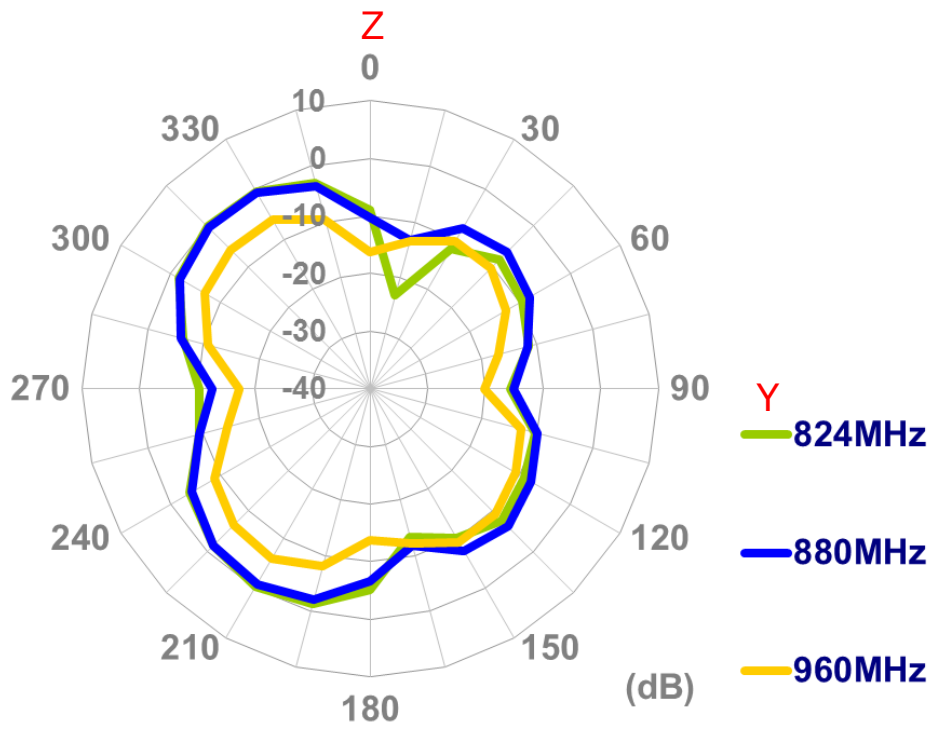

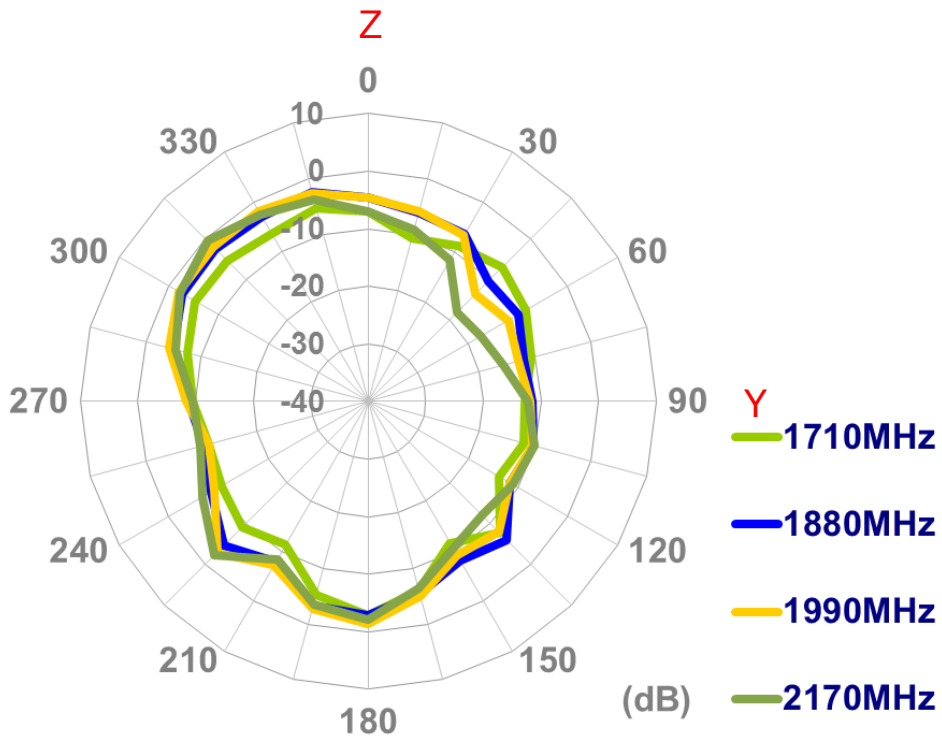
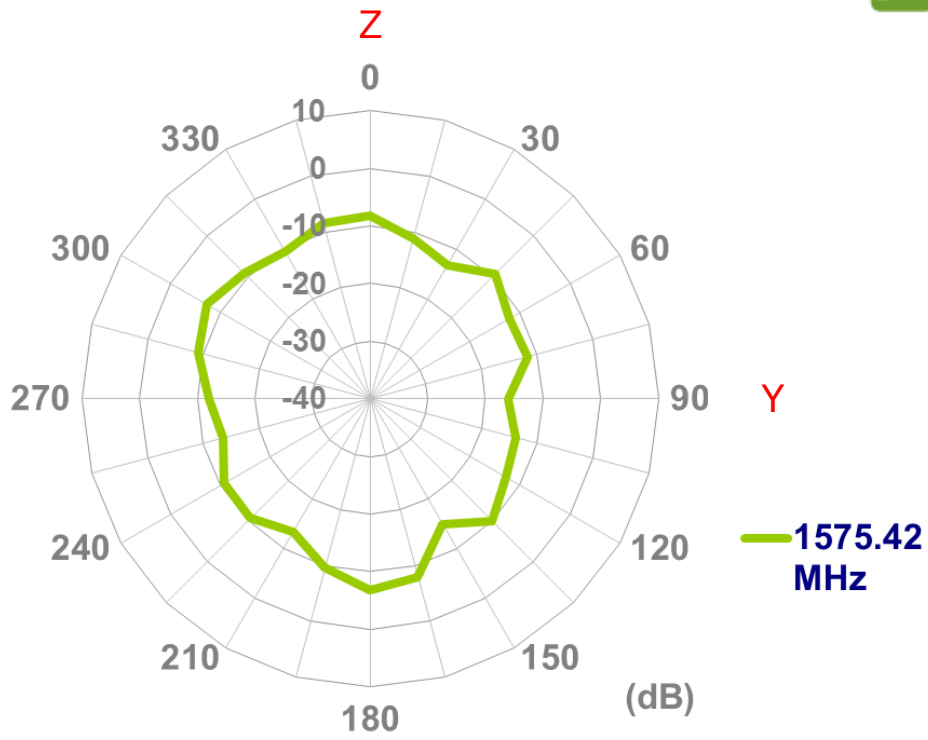

8.5.3 10cm*4cm Ground Plane

Setup

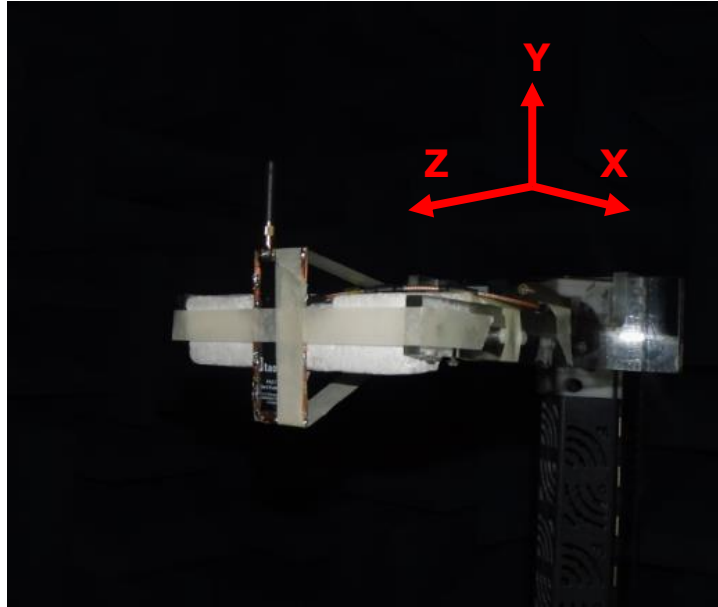

XY Plane

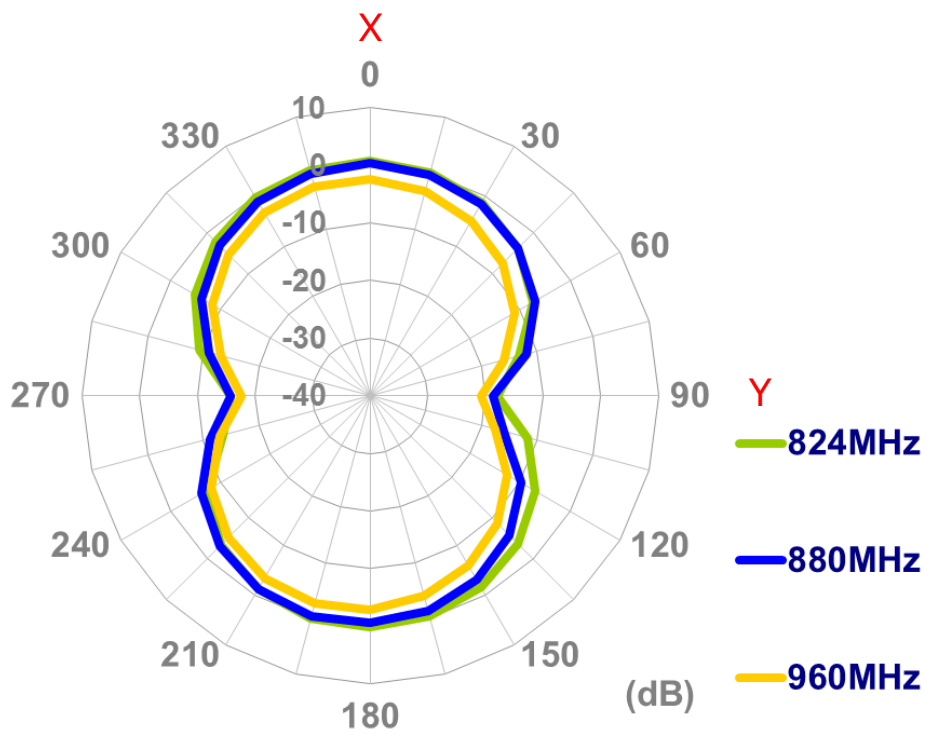

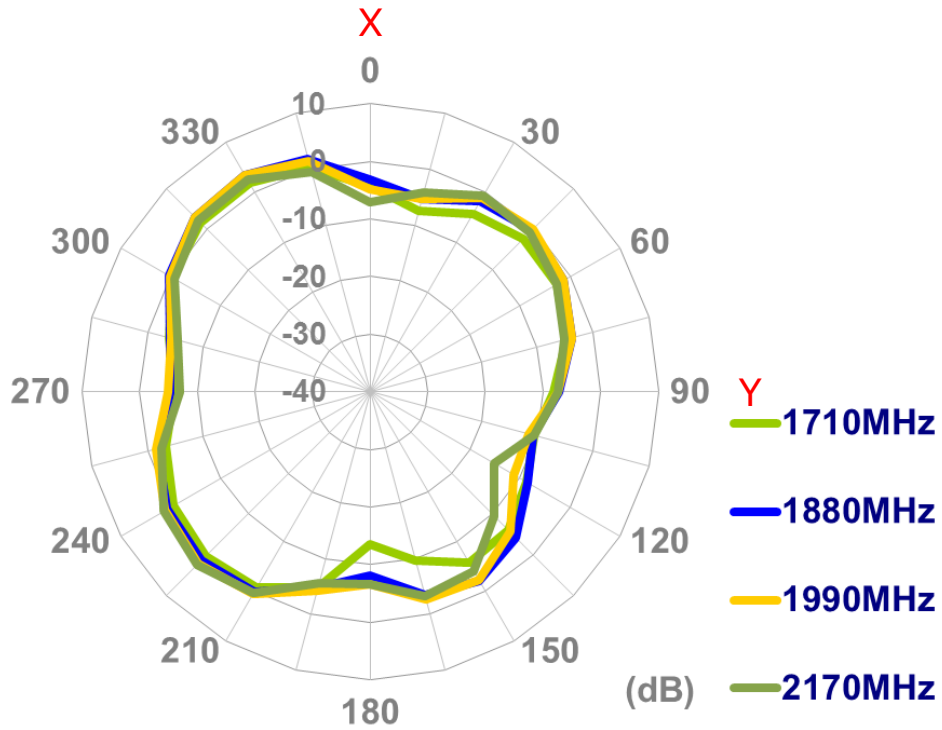
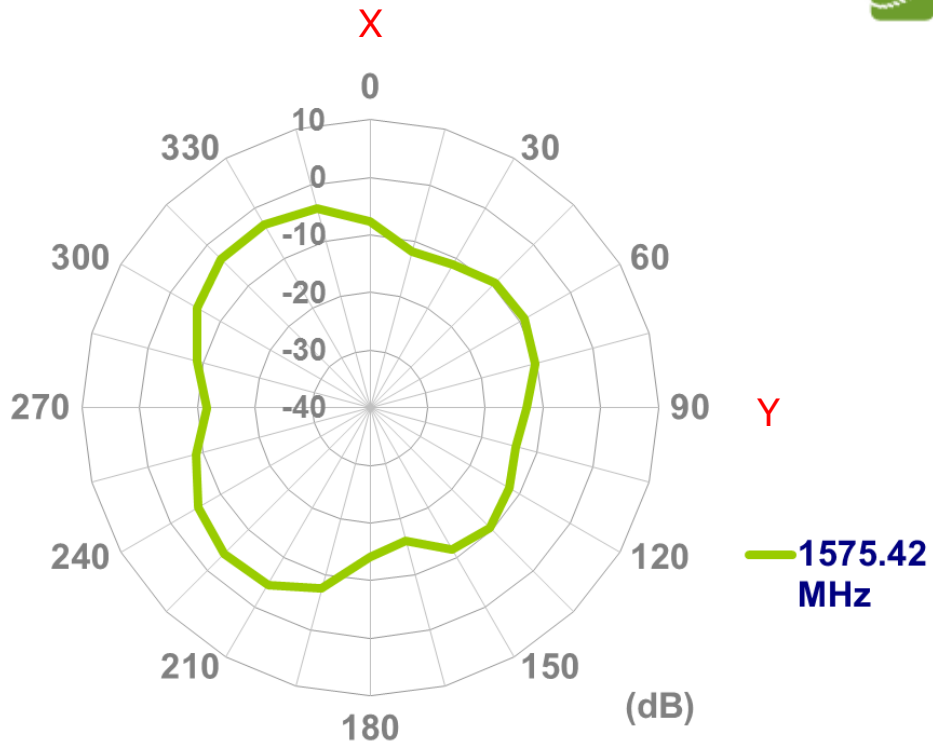

XZ Plane

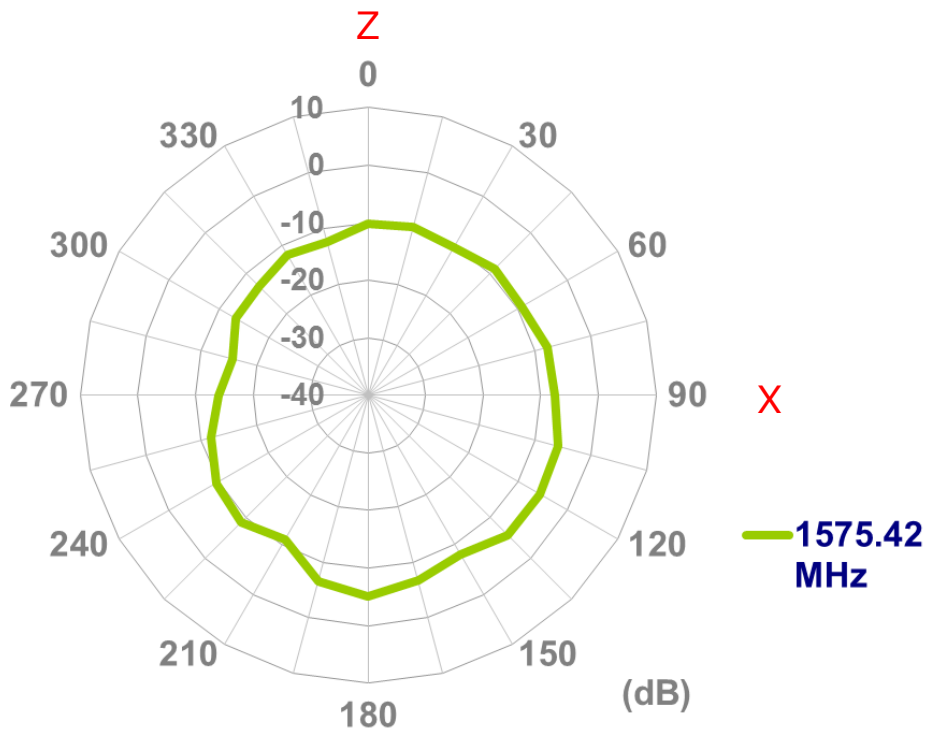
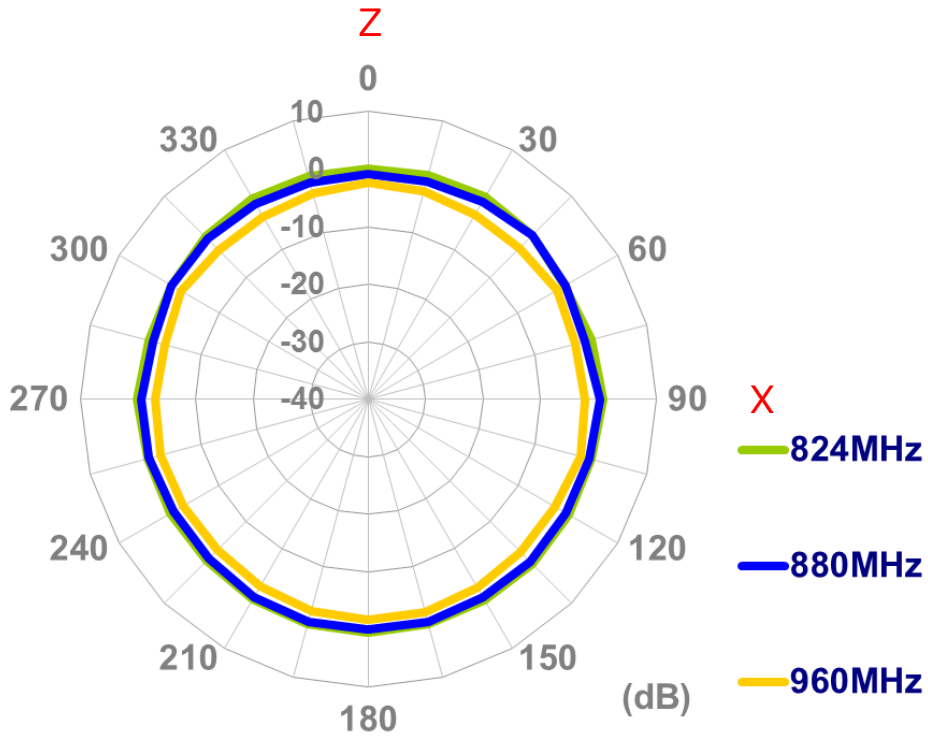

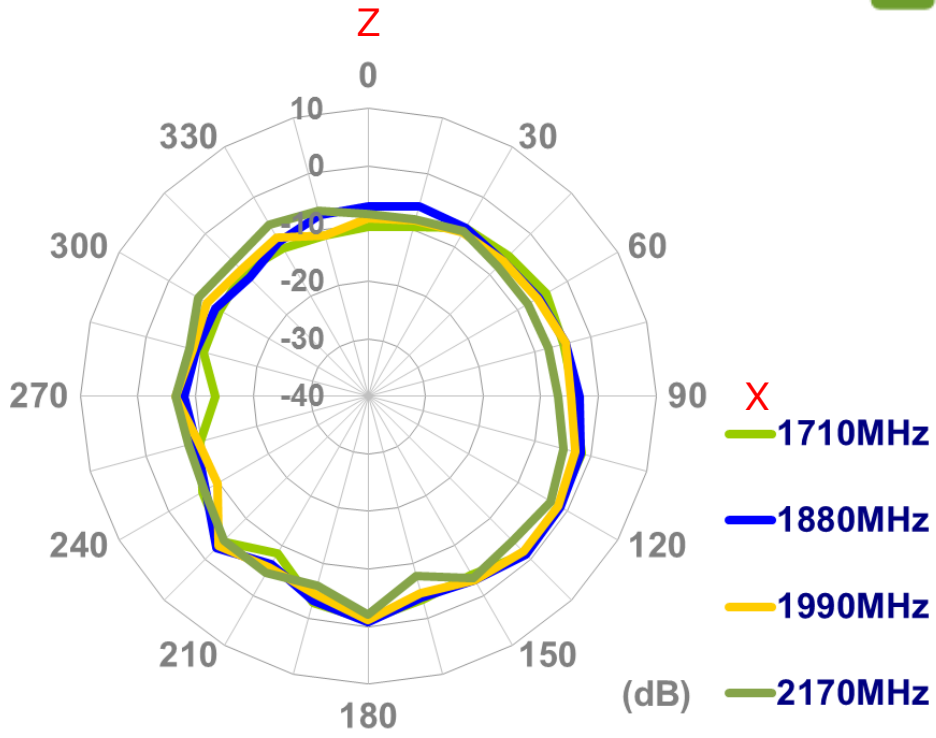

YZ Plane

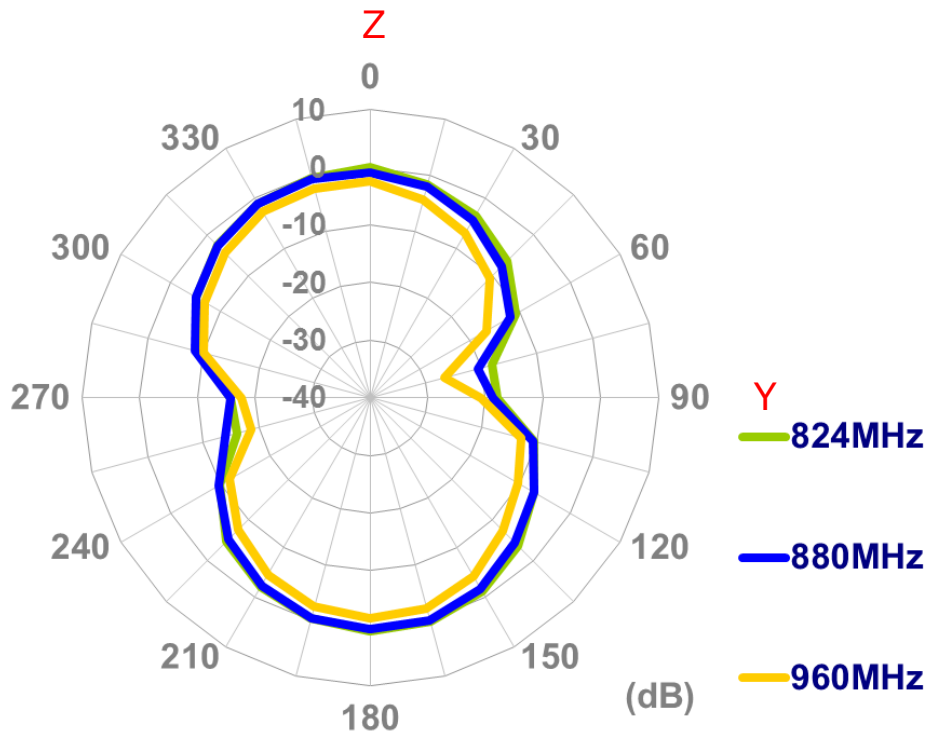

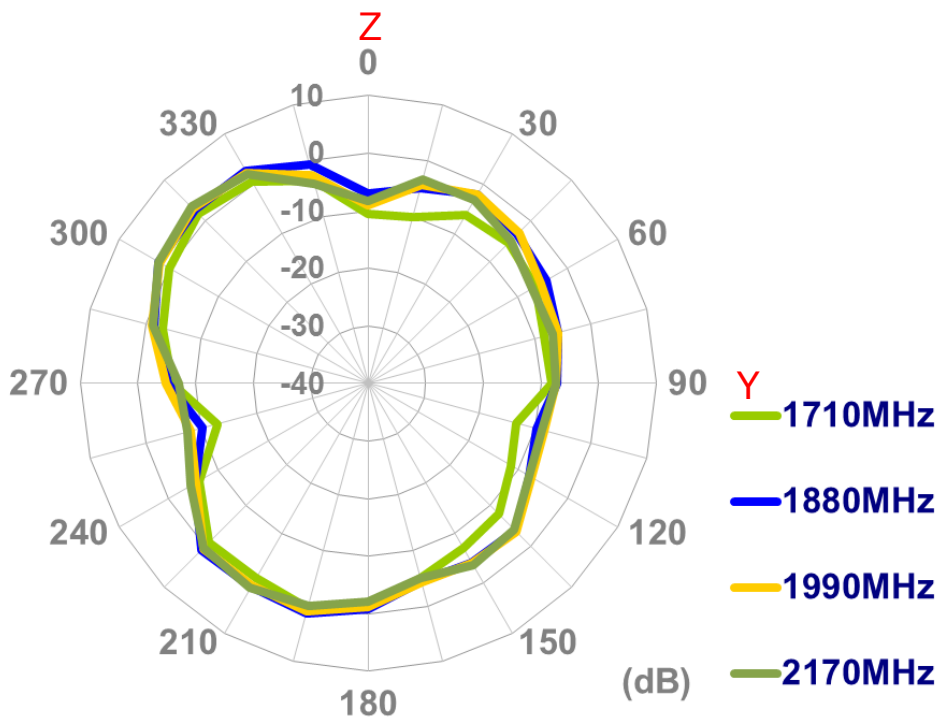
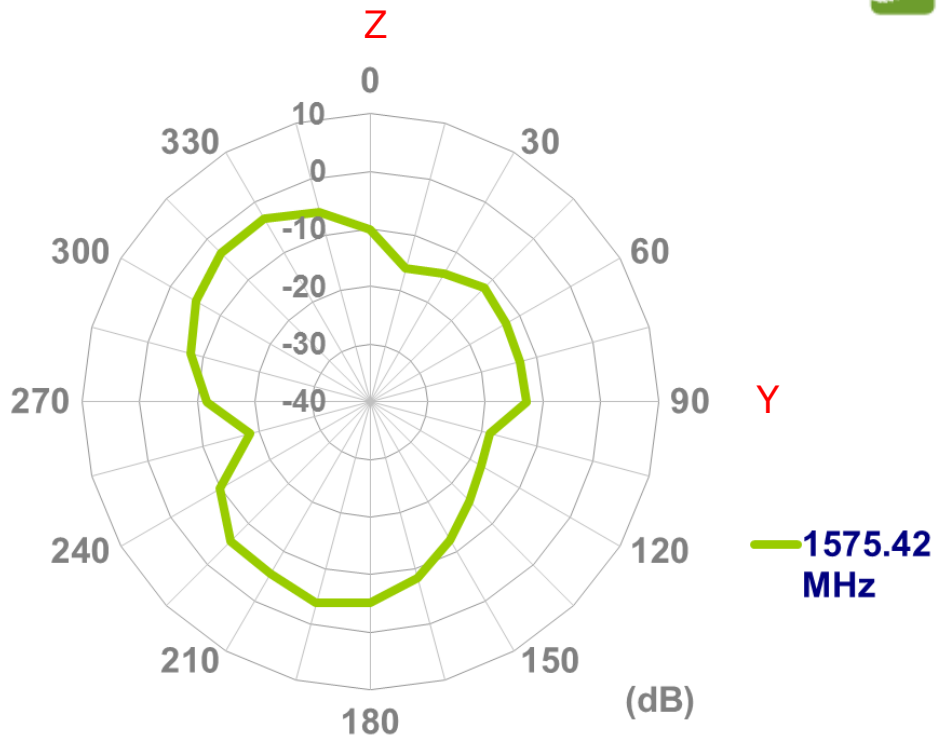

Компания «Океан Электроники» предлагает заключение долгосрочных отношений при поставках импортных электронных компонентов на взаимовыгодных условиях!

Наши преимущества:

- Поставка оригинальных импортных электронных компонентов напрямую с производств Америки, Европы и Азии, а так же с крупнейших складов мира;
- Широкая линейка поставок активных и пассивных импортных электронных компонентов (более 30 млн. наименований);
- Поставка сложных, дефицитных, либо снятых с производства позиций;
- Оперативные сроки поставки под заказ (от 5 рабочих дней);
- Экспресс доставка в любую точку России;
- Помощь Конструкторского Отдела и консультации квалифицированных инженеров;
- Техническая поддержка проекта, помощь в подборе аналогов, поставка прототипов;
- Поставка электронных компонентов под контролем ВП;
- Система менеджмента качества сертифицирована по Международному стандарту ISO 9001;
- При необходимости вся продукция военного и аэрокосмического назначения проходит испытания и сертификацию в лаборатории (по согласованию с заказчиком);
- Поставка специализированных компонентов военного и аэрокосмического уровня качества (Xilinx, Altera, Analog Devices, Intersil, Interpoint, Microsemi, Actel, Aeroflex, Peregrine, VPT, Syfer, Eurofarad, Texas Instruments, MS Kennedy, Miteq, Cobham, E2V, MA-COM, Hittite, Mini-Circuits, General Dynamics и др.);

Компания «Океан Электроники» является официальным дистрибьютором и эксклюзивным представителем в России одного из крупнейших производителей разъемов военного и аэрокосмического назначения «JONHON», а так же официальным дистрибьютором и эксклюзивным представителем в России производителя высокотехнологичных и надежных решений для передачи СВЧ сигналов «FORSTAR».



JONHON

«JONHON» (основан в 1970 г.)

Разъемы специального, военного и аэрокосмического назначения:

(Применяются в военной, авиационной, аэрокосмической, морской, железнодорожной, горно- и нефтедобывающей отраслях промышленности)

«FORSTAR» (основан в 1998 г.)

ВЧ соединители, коаксиальные кабели, кабельные сборки и микроволновые компоненты:

(Применяются в телекоммуникациях гражданского и специального назначения, в средствах связи, РЛС, а так же военной, авиационной и аэрокосмической отраслях промышленности).



Телефон: 8 (812) 309-75-97 (многоканальный)

Факс: 8 (812) 320-03-32

Электронная почта: ocean@oceanchips.ru

Web: <http://oceanchips.ru/>

Адрес: 198099, г. Санкт-Петербург, ул. Калинина, д. 2, корп. 4, лит. А