

GP2A231LRSA

Light Modulation, Reflection Type OPIC Photointerrupter

■ Features

1. Light modulation system impervious to external disturbing light
2. Compact and 3-pin connector output type
3. Long focal distance type
(Optimum detecting distance : 3 to 7 mm)
4. Capable of TTL direct connection

■ Applications

1. Copiers
2. Facsimiles
3. LBPs

■ Absolute Maximum Ratings

(T_a=25°C)

Parameter	Symbol	Rating	Unit
Supply voltage	V _{CC}	-0.5 to +7	V
Output voltage	V _O	7	V
*1 Output current	I _{OL}	50	mA
*2 Operating temperature	T _{opr}	-10 to +70	°C
Storage temperature	T _{stg}	-20 to +80	°C

*1 Output current vs. ambient temperature: Refer to Fig.5

Sink current

*2 The connector should be plugged in/out at normal temperature

■ Outline Dimensions

(Unit : mm)

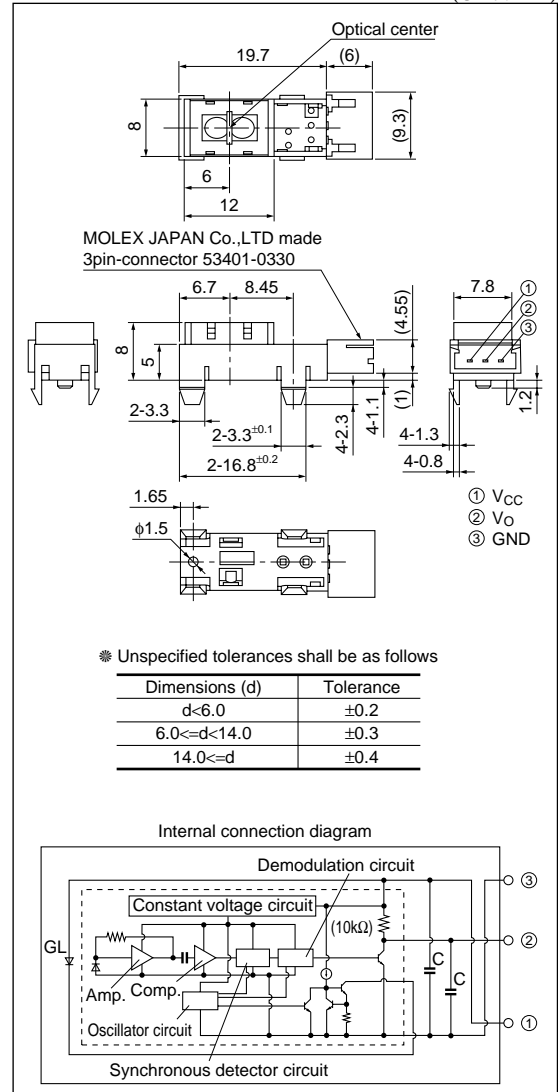

* "OPIC" (Optical IC) is a trademark of the SHARP Corporation.

An OPIC consists of a light-detecting element and signal-processing circuit integrated onto a single chip.

■ Electro-optical Characteristics

($V_{CC}=5V, T_a=25^{\circ}C$)

Parameter	Symbol	Conditions	MIN.	TYP.	MAX.	Unit
Supply voltage	V_{CC}	—	4.75	—	5.25	V
Dissipation current (I)	I_{CC}	$V_{CC}=5V, R_L=\infty$, smoothing value	—	—	20	mA
Dissipation current (II)	I_{CCP}	^{*3} $V_{CC}=5V$, peak pulse value	—	—	100	mA
Low level output voltage	V_{OL}	$V_{CC}=5V, I_{OL}=16mA$, at detecting time	—	—	0.4	V
High level output voltage	V_{OH}	$V_{CC}=5V, R_L=\infty$, at non-detecting time	4.5	—	—	V
Non-detecting distance	L_{LHL}	^{*4} Kodak 90% reflective paper, $V_{CC}=5V$	—	—	27.0	mm
Detecting distance	L_{HLS}	^{*4} Kodak 90% reflective paper, $V_{CC}=5V$	—	—	1.0	mm
	L_{HLS}	^{*4} Black paper, $V_{CC}=5V$	—	—	3.0	mm
	L_{HLL}	^{*4} Kodak 90% reflective paper, $V_{CC}=5V$	9.0	—	—	mm
	L_{HLL}	^{*4} Black paper, $V_{CC}=5V$	7.0	—	—	mm
Response time	t_{PHL}	^{*5} $V_{CC}=5V$	—	—	1.0	ms
	t_{PLH}	^{*5} $V_{CC}=5V$	—	—	1.0	ms
External disturbing light illuminance	E_{V1}	^{*6}	3 000	—	—	lx
	E_{V2}	^{*6}	1 500	—	—	lx

*3 Refer to Fig.1

*4 Refer to Fig.2

*5 Refer to Fig.3

*6 Refer to Fig.4

Fig.1 Test Condition for Peak Pulse Value I_{CCP}

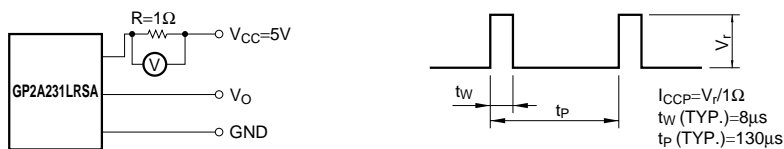

Fig.2 Test Condition for Detecting Distance Characteristics

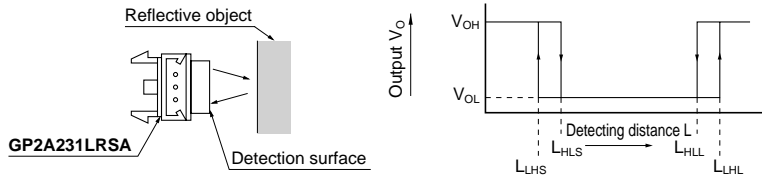

Fig.3 Test Circuit For Response Time

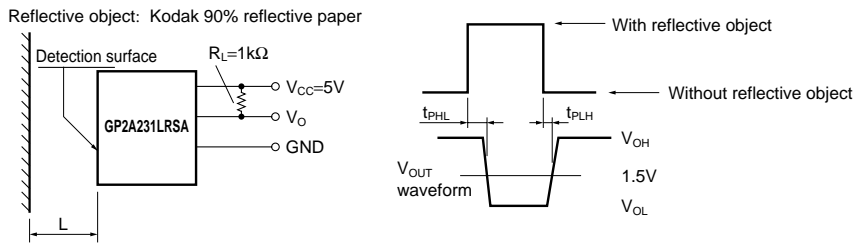

Fig.4 Test Condition for External Disturbing Light Illuminance

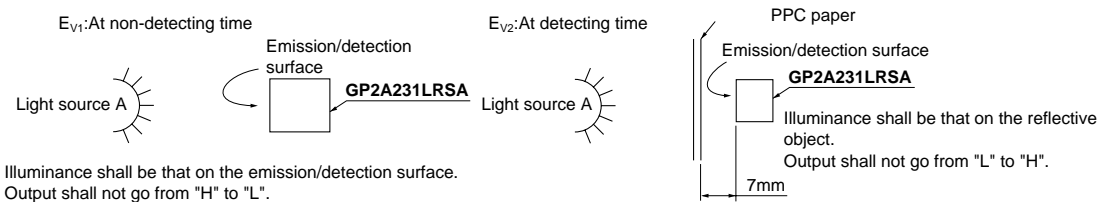
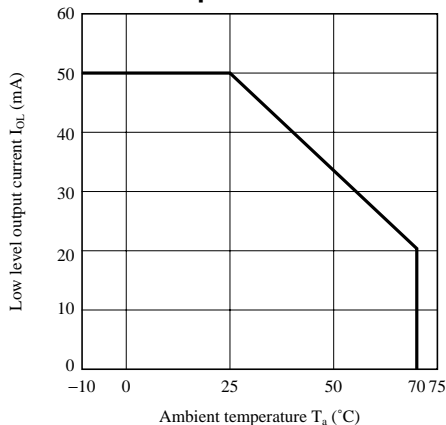
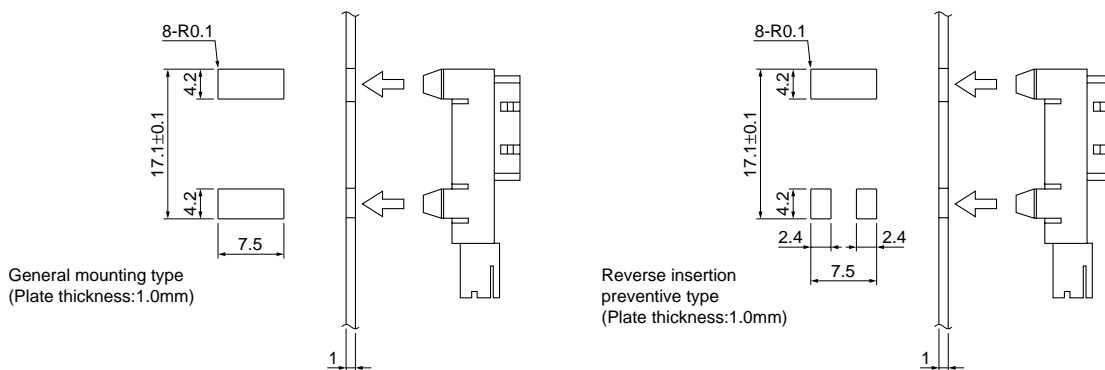

Fig.5 Low Level Output Current vs. Ambient Temperature



■ Recommended Mounting Hole Shape



1. It is recommended to mount the shear droop surface (punch side) of the mounting plate (metal plate) with "GP2A231LRSA".
2. Mounting workability, shaking after mounting and mounting strength depend on the corner radius of the mounting plate and the state of punching.

Determine the mounting dimensions after check on an actual machine.

3. General dimensional tolerances shall be ± 0.1 mm.

■ Precautions for Use

1. In order to stabilize power supply line, connect a by-pass capacitor of more than $0.33\mu\text{F}$ between V_{CC} and GND near the device.
2. For cleaning
 - Acryle resin is used as the material of the lens surface. As to cleaning, this refractive type photointerrupter shall not clean by cleaning materials absolutely. Dust and stain shall clean by air blow, or shall clean by soft cloth soaked in washing materials.
3. The connector should be plugged in / out at normal temperature.

NOTICE

- The circuit application examples in this publication are provided to explain representative applications of SHARP devices and are not intended to guarantee any circuit design or license any intellectual property rights. SHARP takes no responsibility for any problems related to any intellectual property right of a third party resulting from the use of SHARP's devices.
- Contact SHARP in order to obtain the latest device specification sheets before using any SHARP device. SHARP reserves the right to make changes in the specifications, characteristics, data, materials, structure, and other contents described herein at any time without notice in order to improve design or reliability. Manufacturing locations are also subject to change without notice.
- Observe the following points when using any devices in this publication. SHARP takes no responsibility for damage caused by improper use of the devices which does not meet the conditions and absolute maximum ratings to be used specified in the relevant specification sheet nor meet the following conditions:
 - (i) The devices in this publication are designed for use in general electronic equipment designs such as:
 - Personal computers
 - Office automation equipment
 - Telecommunication equipment [terminal]
 - Test and measurement equipment
 - Industrial control
 - Audio visual equipment
 - Consumer electronics
 - (ii) Measures such as fail-safe function and redundant design should be taken to ensure reliability and safety when SHARP devices are used for or in connection with equipment that requires higher reliability such as:
 - Transportation control and safety equipment (i.e., aircraft, trains, automobiles, etc.)
 - Traffic signals
 - Gas leakage sensor breakers
 - Alarm equipment
 - Various safety devices, etc.
 - (iii) SHARP devices shall not be used for or in connection with equipment that requires an extremely high level of reliability and safety such as:
 - Space applications
 - Telecommunication equipment [trunk lines]
 - Nuclear power control equipment
 - Medical and other life support equipment (e.g., scuba).
- If the SHARP devices listed in this publication fall within the scope of strategic products described in the Foreign Exchange and Foreign Trade Law of Japan, it is necessary to obtain approval to export such SHARP devices.
- This publication is the proprietary product of SHARP and is copyrighted, with all rights reserved. Under the copyright laws, no part of this publication may be reproduced or transmitted in any form or by any means, electronic or mechanical, for any purpose, in whole or in part, without the express written permission of SHARP. Express written permission is also required before any use of this publication may be made by a third party.
- Contact and consult with a SHARP representative if there are any questions about the contents of this publication.

Компания «Океан Электроники» предлагает заключение долгосрочных отношений при поставках импортных электронных компонентов на взаимовыгодных условиях!

Наши преимущества:

- Поставка оригинальных импортных электронных компонентов напрямую с производств Америки, Европы и Азии, а так же с крупнейших складов мира;
- Широкая линейка поставок активных и пассивных импортных электронных компонентов (более 30 млн. наименований);
- Поставка сложных, дефицитных, либо снятых с производства позиций;
- Оперативные сроки поставки под заказ (от 5 рабочих дней);
- Экспресс доставка в любую точку России;
- Помощь Конструкторского Отдела и консультации квалифицированных инженеров;
- Техническая поддержка проекта, помощь в подборе аналогов, поставка прототипов;
- Поставка электронных компонентов под контролем ВП;
- Система менеджмента качества сертифицирована по Международному стандарту ISO 9001;
- При необходимости вся продукция военного и аэрокосмического назначения проходит испытания и сертификацию в лаборатории (по согласованию с заказчиком);
- Поставка специализированных компонентов военного и аэрокосмического уровня качества (Xilinx, Altera, Analog Devices, Intersil, Interpoint, Microsemi, Actel, Aeroflex, Peregrine, VPT, Syfer, Eurofarad, Texas Instruments, MS Kennedy, Miteq, Cobham, E2V, MA-COM, Hittite, Mini-Circuits, General Dynamics и др.);

Компания «Океан Электроники» является официальным дистрибьютором и эксклюзивным представителем в России одного из крупнейших производителей разъемов военного и аэрокосмического назначения «JONHON», а так же официальным дистрибьютором и эксклюзивным представителем в России производителя высокотехнологичных и надежных решений для передачи СВЧ сигналов «FORSTAR».



JONHON

«JONHON» (основан в 1970 г.)

Разъемы специального, военного и аэрокосмического назначения:

(Применяются в военной, авиационной, аэрокосмической, морской, железнодорожной, горно- и нефтедобывающей отраслях промышленности)

«FORSTAR» (основан в 1998 г.)

ВЧ соединители, коаксиальные кабели, кабельные сборки и микроволновые компоненты:

(Применяются в телекоммуникациях гражданского и специального назначения, в средствах связи, РЛС, а так же военной, авиационной и аэрокосмической отраслях промышленности).



Телефон: 8 (812) 309-75-97 (многоканальный)

Факс: 8 (812) 320-03-32

Электронная почта: ocean@oceanchips.ru

Web: <http://oceanchips.ru/>

Адрес: 198099, г. Санкт-Петербург, ул. Калинина, д. 2, корп. 4, лит. А