



User Guide for
FEBFAN9673Q_B1H5000A
Evaluation Board

5 kW Three-Channel CCM PFC
with 12 V_{SB} Module
Evaluation Board

Featured Fairchild Product:
FAN9673Q

*Direct questions or comments
about this evaluation board to:
“Worldwide Direct Support”*

Fairchild Semiconductor.com



Table of Contents

1. Introduction.....	3
1.1. Features	3
2. Evaluation Board Specifications.....	3
3. Photograph	4
4. Printed Circuit Board	5
5. Schematic	8
6. Bill of Materials	10
7. Transformer and Winding Specifications	13
7.1. TX2 Specification	13
7.2. L1 & L2 Specification.....	14
7.3. L3, L4, & L5 Specification	15
7.4. L11 Specification	16
8. Test Conditions & Test Equipment.....	17
8.1. Features	17
8.2. Test Procedure.....	17
9. Performance of Evaluation Board.....	18
9.1. AC Trim Up & Trim Down.....	18
9.2. PFC ON / OFF & RDY	18
9.3. Ripple & Noise.....	19
9.4. Efficiency	19
9.5. Current Harmonic.....	20
10. Notice Letter	24
11. Safety Precautions.....	25
12. Revision History	26



This user guide supports the 5000 W evaluation board for a three-channel CCM PFC using the FAN9673. It should be used in conjunction with the FAN9673 datasheet as well as Fairchild's application notes and technical support team. Please visit Fairchild's website at www.fairchildsemi.com/.

1. Introduction

The FAN9673 is a 32-pin, Continuous Conduction Mode (CCM) Power Factor Correction (PFC) controller IC intended for PFC pre-regulators. The FAN9673 includes average current and boost-type power factor correction, which results in a power supply that fully complies with the IEC1000-3-2 specification. A TriFault Detect™ function helps reduce external components and provides full protection for feedback loops, such as over voltage. An over-voltage comparator shuts down the PFC stage in the event of a sudden load decrease. The RDY signal can be used for power-on sequence control. The Channel Management (CM) function can enable / disable the each channel independently. The FAN9673 also includes PFC soft-start, peak current limiting, and input voltage brown-in/out protection.

1.1. Features

- Continuous Conduction Mode Control
- Maximum Three-Channel PFC Control
- Average Current Mode Control
- PFC Slave Channels External Signal / Channel Management Function Control
- Programmable Operation Frequency Range: 18 kHz~40 kHz or 55 kHz~75 kHz
- Programmable PFC Output Voltage
- Two Types of Current Limit
- TriFault Detect™ Protects Against Feedback Loop Failure
- SAG Protection
- Programmable Soft Start
- Under-Voltage Lockout (UVLO)
- Differential Current Sensing
- Available in 32-Pin LQFP Package

2. Evaluation Board Specifications

All data for this table was measured at an ambient temperature of 25°C.

Table 1. Summary of Features and Performance

Description	Symbol	Value	Comments
Output Power	P_O	5 kW	
Efficiency	Eff, η	>95%	
Input Voltage	V_{AC}	180~264 V	
Input Frequency		47~63 Hz	
Output Voltage	V_{OUT}, V_{PFC}	393 V	$V_{PVO}=0$ V
Brown In / Out Voltage	V_{AC}	170 V / 155 V	
PFC Frequency	f_{SW}	40 kHz	
PFC RDY	V_{RDY}	2.4 V / 1.55 V (96% / 62% of V_{PFC})	

3. Photograph

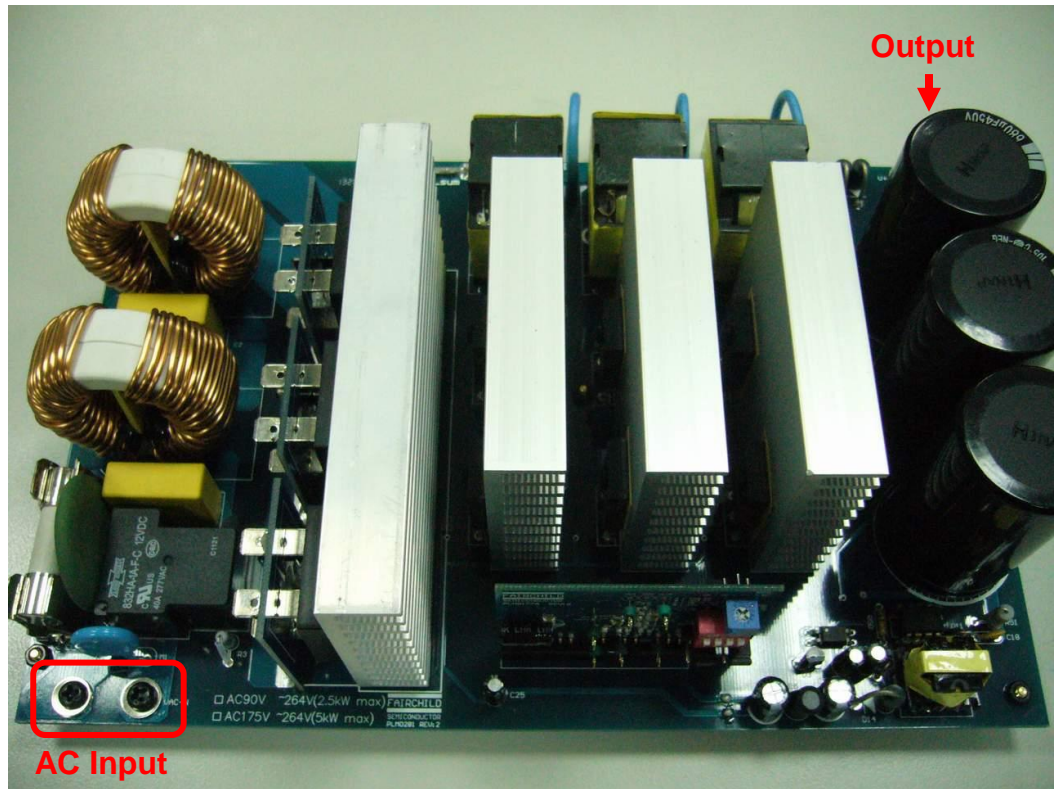

Figure 1. Top View of Evaluation Board

4. Printed Circuit Board

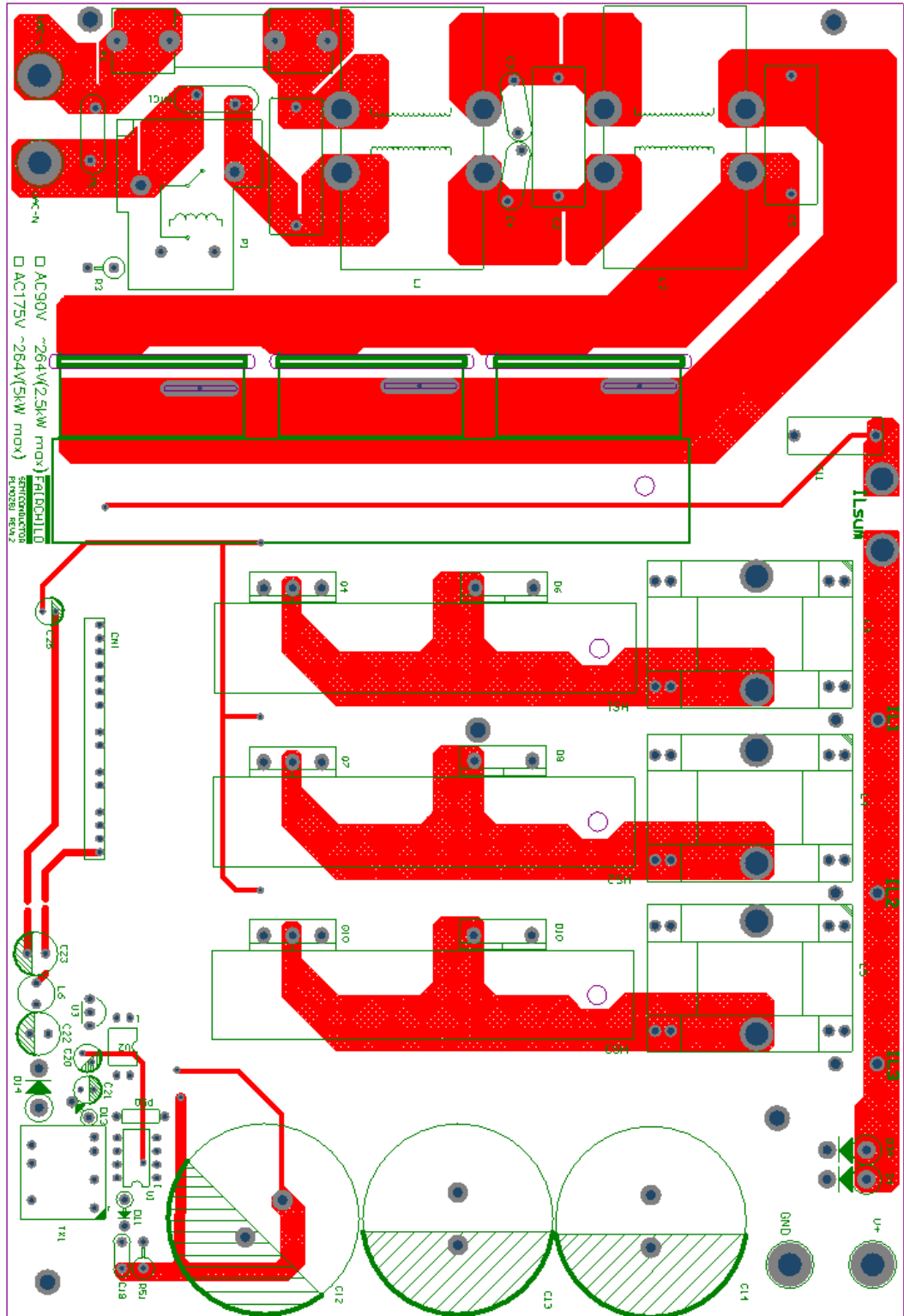

Figure 2. Top Side of Evaluation Board

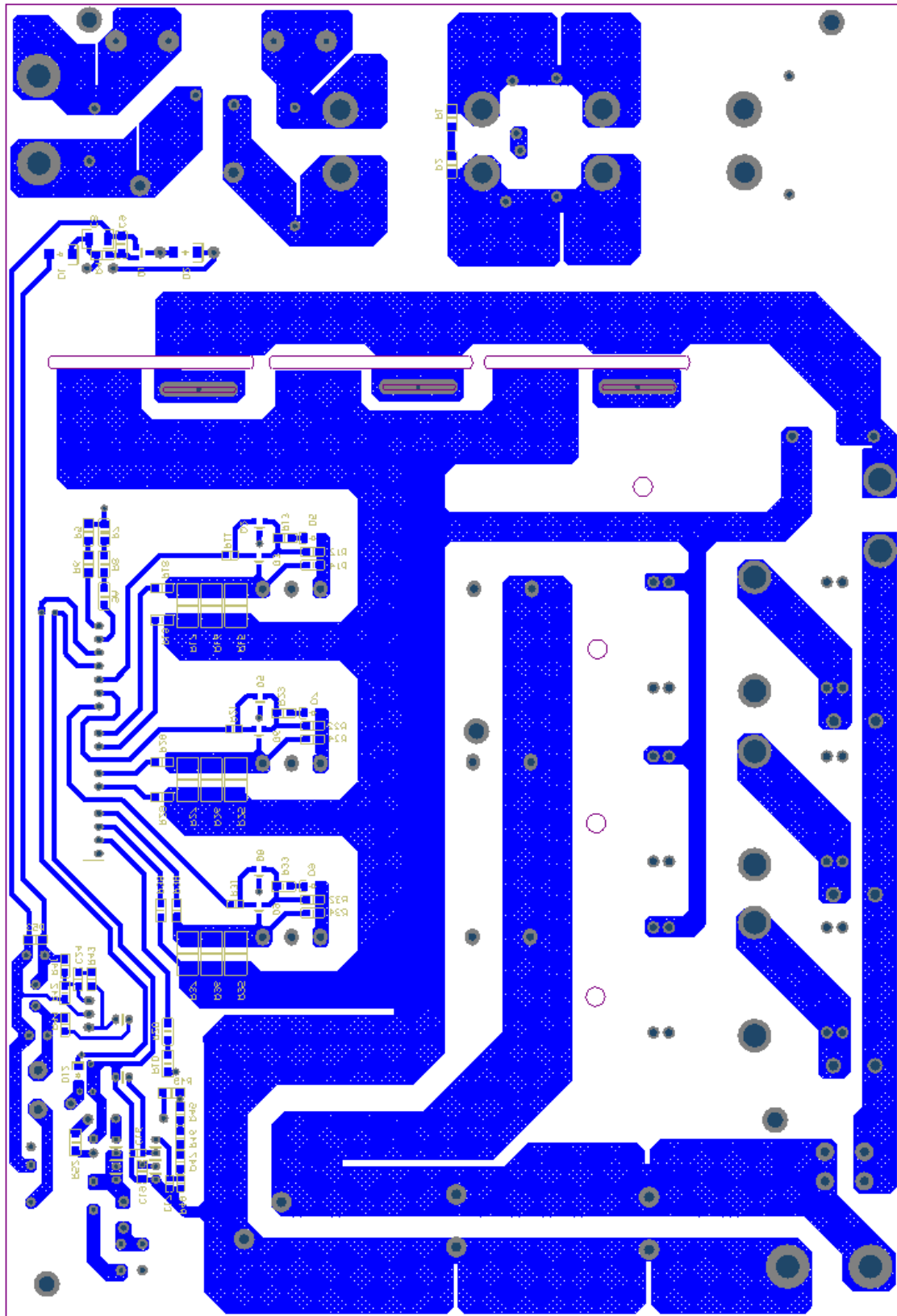

Figure 3. Bottom Side of Evaluation Board

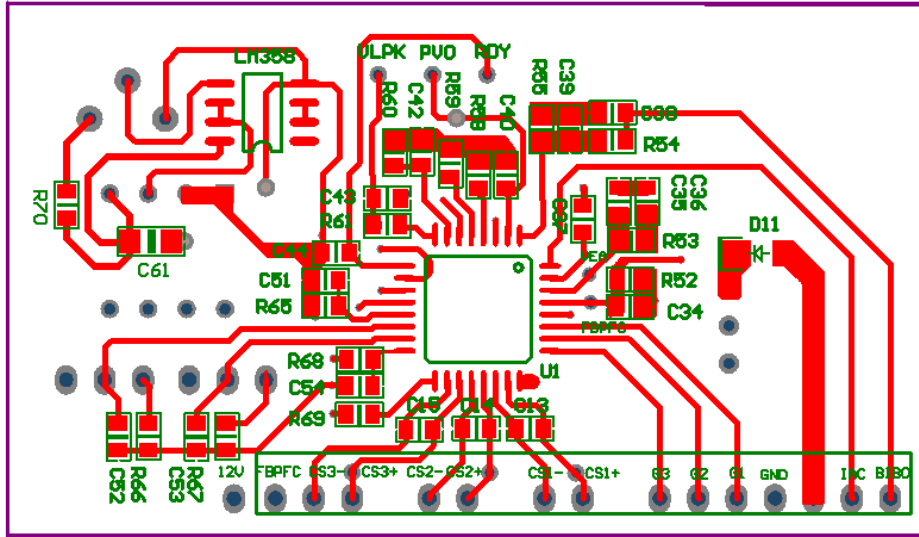

Figure 4. Top Side of Daughter Card

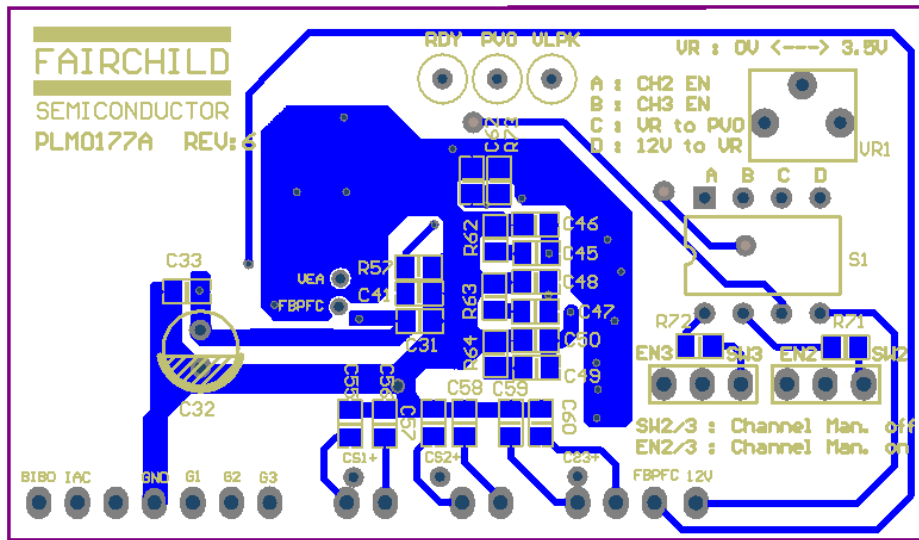

Figure 5. Bottom Side of Daughter Card

5. Schematic

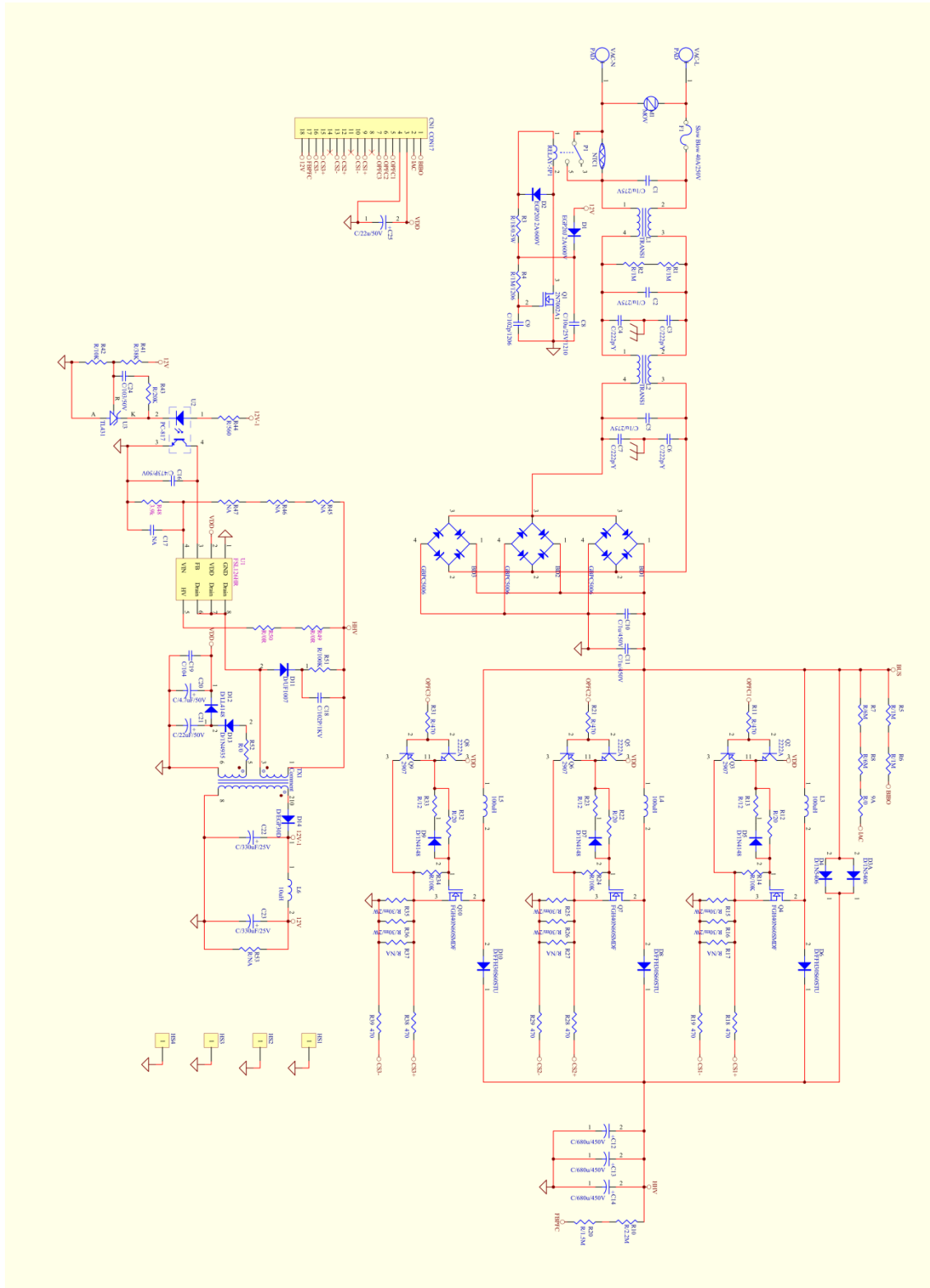

Figure 6. Evaluation Board Schematic

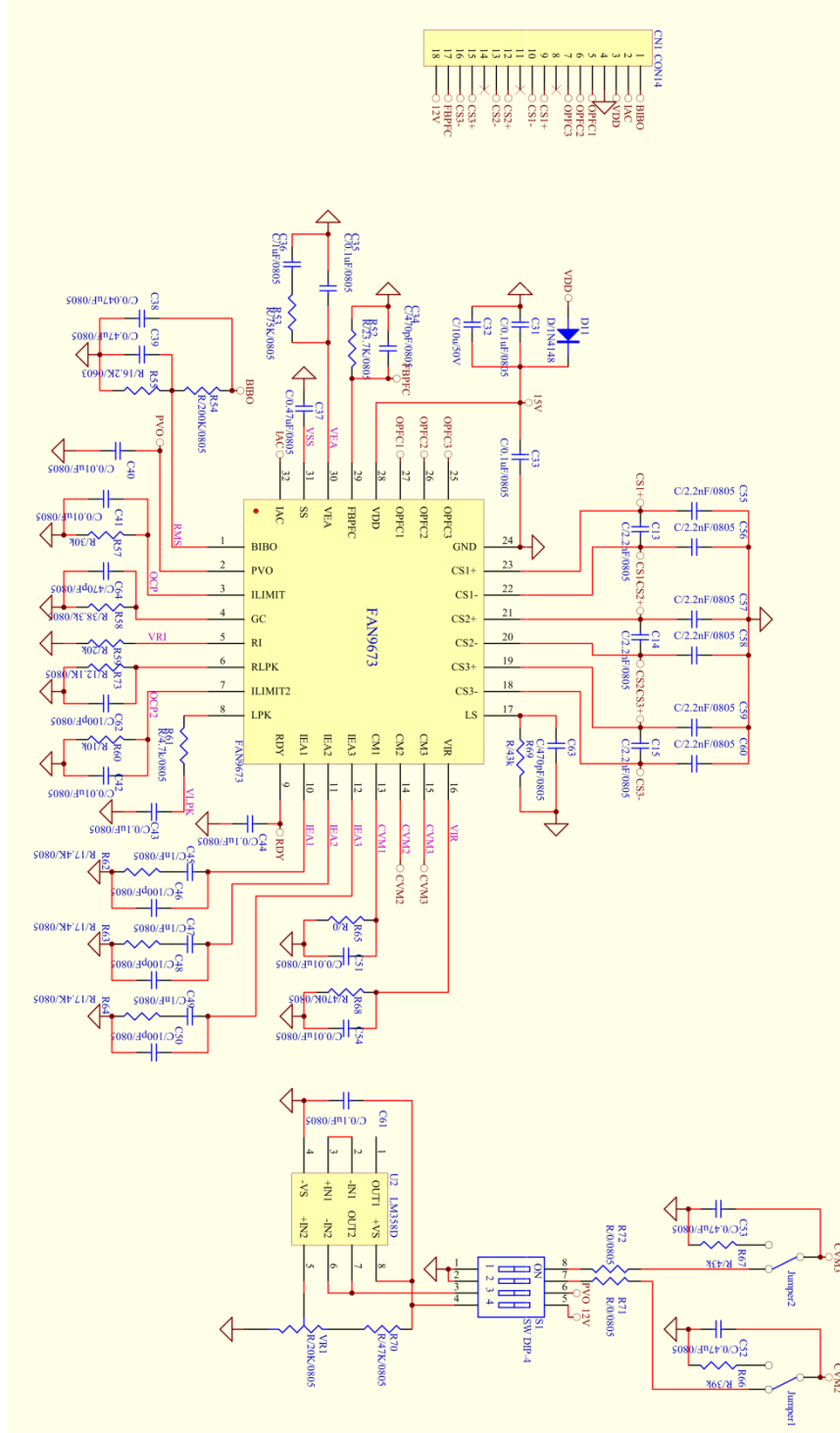

Figure 7. Daughter Card Schematic



6. Bill of Materials

Main Board (PLM281 REV.2)					
Reference	Qty.	Part Number	Value	Description	Manufacturer
BD1, BD2, BD3	3	GBPC5006			
PLM0276AV0 x3	3			Transfer Card for Bridge	
C1, C2, C5	3		1 μ F / 275 V		
C10	1		1 μ F / 450 V		
C12, C13, C14	3		680 μ F / 450 V		
C16	1		47 nF / 50 V		
C18	1		1 nF / 1 kV		
C19	1		0.1 μ F		
C20	1		4.7 μ F / 50 V		
C21, C25	2		22 μ F / 50 V		
C22, C23	2		330 μ F / 25 V		
C24	1		10 nF / 50 V		
C3, C4	2		2.2 pF / 250 V		
C8	1		10 μ F / 25 V		
C9	1		1 nF / 1 kV		
CN1	1			CON18	
D1, D2	2	S1J			
D11	1	UF1007			
D13	1	1N4935			Fairchild
D14	1	EGP30D			
D3, D4	2	1N5406			Fairchild
D5, D7, D9, D12	4	1N4148			
D6, D8, D10	3	FFH30S60STU			Fairchild
F1	1	Slow Blow Fuse	40 A / 250 V		
HS1	1	H-sink			
HS2, HS3, HS4	3	H-sink			
L1, L2	2	FS4015H-2LB		EMI	FORMOSA SHING GA ENTERPRISE CO., LTE.
L3, L4, L5	3	Core Type: QP3925H	100 μ H		
L6	1		10 μ H		
M1	1		MOV		
Q1	1	2N7002A			
Q2, Q5, Q8	3	2222A			
Q3, Q6, Q9	3	2907			
Q4, Q7, Q10	3	FGH40N60SMDF			Fairchild
R1, R2, R4, R5, R6	5		1 M Ω		
R11, R21, R31	3		470 Ω		
R12, R22, R32	3		20 Ω		



Main Board (PLM281 REV.2)					
Reference	Qty.	Part Number	Value	Description	Manufacturer
R13, R23, R33	3		12 Ω		
R14, R24, R34, R42	4		10 k Ω		
R15, R16, R25, R26, R35, R36	6		30 m Ω / 2 W		
R18, R19, R28, R29, R38, R39	6		470 Ω		
R20	1		1.5 M Ω		
R3	1		20 Ω		
R41	1		38.3 k Ω		
R43	1		20 k Ω		
R44	1		560 Ω		
R48	1		3.9 k Ω		
R49, R50, R52	3		0 Ω		
R51	1		100 k Ω		
R7	1		5.1 M Ω		
R8	1		4.7 M Ω		
R9A, R10	2		2.2 M Ω		
Relay1	1	Power Relay	40 A		
TX1	1	750342371		12 V _{SB} Transformer	Würth Elektronik
U1	1	FSL126HR		Controller	Fairchild
U2	1	PC-817			
U3	1	TL431			

Daughter Card (PLM0177A REV.6)					
Reference	Qty.	Part Number	Value	Description	Manufacturer
C35, C40, C41, C42, C51, C54	6	SMD 0805	0.01 μ F		
C38	1	SMD 0805	0.047 μ F		
C31, C33, C43, C44, C61	5	SMD 0805	0.1 μ F		
C36, C37, C39, C52, C53	5	SMD 0805	0.47 μ F		
C45, C47, C49	3	SMD 0805	1.2 nF		
C46, C48, C50, C62	4	SMD 0805	100 pF		
C32	1		10 μ / 50 V		
C13, C14, C15	3	SMD 0805	2.2 nF		
C55, C56, C57, C58, C59, C60	6	SMD 0805	2.2 nF		
C34, C63, C64	1	SMD 0805	470 pF		
CN1	1			CON14	
D11	1		1N4148		



Daughter Card (PLM0177A REV.6)					
Reference	Qty.	Part Number	Value	Description	Manufacturer
U1	1	FAN9673		Controller	Fairchild
U2	1	LM358D			Fairchild
R56, R65, R72, R71	4	SMD 0805	0 Ω		
R60	1	SMD 0805	10 k Ω		
R73	1	SMD 0805	12.1 k Ω		
R55	1	SMD 0603	16.2 k Ω		
R62, R63, R64	3	SMD 0805	17.4 k Ω		
R69	1	SMD 0805	43 k Ω		
R54	1	SMD 0805	200 k Ω		
R59	1	SMD 0805	20 k Ω		
VR1	1	SMD 0805	20 k Ω		
R52	1	SMD 0805	23.7 k Ω		
R57	1	SMD 0805	30 k Ω		
R58	1	SMD 0805	38.3 k Ω		
R61	1	SMD 0805	4.7 k Ω		
R68	1	SMD 0805	470 k Ω		
R66, R67, R70	3	SMD 0805	47 k Ω		
R53	1	SMD 0805	75 k Ω		
S1	1	DIP-4		Switch	

7. Transformer and Winding Specifications

7.1. TX2 Specification

- Core: EE-16 (3C94)
- Bobbin: 10 Pins

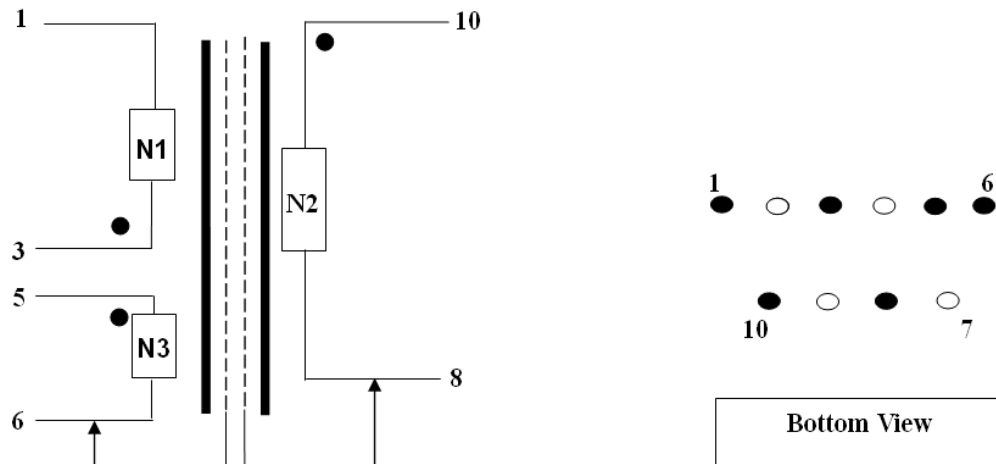

Figure 8. Transformer Specifications & Construction

Table 2. Winding Specifications

No.	Winding	Pin (S → F)	Wire	Turns	Winding Method
1	N1	3 → 2	0.29φ×1	36	Solenoid Winding
2	Insulation: Polyester Tape t = 0.025 mm, 3-Layer				
3	N2	10 → 8	0.35φ×3	10	Solenoid Winding
4	Insulation: Polyester Tape t = 0.025 mm, 3-Layer				
5	N1	2 → 1	0.29φ×1	18	Solenoid Winding
6	Insulation: Polyester Tape t = 0.025 mm, 6-Layer				
7	N3	5 → 6	0.15φ×1	13	Solenoid Winding
8	Insulation: Polyester Tape t = 0.025 mm, 3-Layer				
9	Copper-Foil 1.2T to PIN6				

Table 3. Electrical Characteristics

	Pins	Specifications
Inductance	3 - 1	800 μH ±5%

7.2. L1 & L2 Specification

FORMOSA SHING GA ENTERPRISE CO., LTD.

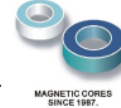

SPECIFICATION FOR PRODUCTS

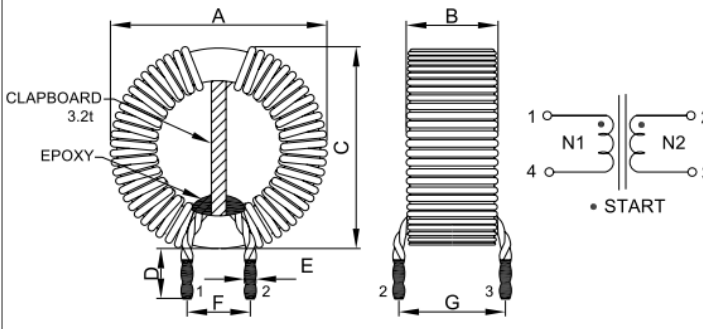
CUST	FAIRCHILD		OUT DWG NO.																				
ITEM	SN-403215-A		DATE	2014/06/16																			
PART NO.			REV:A2																				
1.SCHEMATIC DIMENSION:																							
				<table border="1"> <thead> <tr> <th colspan="2">SPEC.(mm)</th> </tr> </thead> <tbody> <tr> <td>A</td> <td>53.0 MAX</td> </tr> <tr> <td>B</td> <td>27.0 MAX</td> </tr> <tr> <td>C</td> <td>49.0 MAX</td> </tr> <tr> <td>D</td> <td>10.0±1.0</td> </tr> <tr> <td>E</td> <td>4.0 MAX</td> </tr> <tr> <td>F</td> <td>10.0 REF</td> </tr> <tr> <td>G</td> <td>24.0 REF</td> </tr> </tbody> </table>				SPEC.(mm)		A	53.0 MAX	B	27.0 MAX	C	49.0 MAX	D	10.0±1.0	E	4.0 MAX	F	10.0 REF	G	24.0 REF
SPEC.(mm)																							
A	53.0 MAX																						
B	27.0 MAX																						
C	49.0 MAX																						
D	10.0±1.0																						
E	4.0 MAX																						
F	10.0 REF																						
G	24.0 REF																						
*Vacuum Varnish Processed																							
2.WINDING & ELECTRONICS: (150kHz 0.1V)30°C																							
ITEM	START	FINISH	MATERIAL	TURNS	COLOR	INDUCTANCE	DCR(mΩ)																
N1	1	4	2UEW φ 1.6*2P	16TS	N	1.0mH MIN	/																
N2	2	3	2UEW φ 1.6*2P	16TS	N	1.0mH MIN	/																
3.TEST INSTRUMENTS: L.C.R.CH-1062;502B																							
4.MATERIAL LIST:																							
NO	ITEM	MATERIAL	SUPPLIER		UL NO.	CLASS																	
1	CORE	SN403215-A	FORMOSA SHING GA ENTERPRISE CO., LTD.																				
2	WIRE	2UEW	PACIFIC ELECTRIC WIRE & CABLE CO.,LTD.		E201757	130°C																	
3	EPOXY	G-9008	GUDAK CHEMISTRY TECH.(D.G)LTD		E218090	90°C																	
4	CLAPBOARD	FR-4	HUIZHOU JIANYONG INSULATED PRODUCT CO.,LTD		E123995	130°C																	
5	MYLAR TAPE	CT-280	HUIZHOU YAHUA STICKING TAPE CO.,LTD		E165111																		
6	VARNISH	V1630FS	ELANTAS ELECTRICAL INSULATION ELANTAS PDG INC		E75225																		
CUSTOMER		APPROVAL		CHECKED		DRAWN																	
		AI-PING		STEVEN CHANG		SANDY CHEN																	

■ TEL : 886-2-87875958 ■ FAX : 886-2-87875969 ■ E-MAIL : philip01@ms2.hinet.net

7.3. L3, L4, & L5 Specification

- Core: QP3925H (3C94)
- Bobbin: 7 Pins

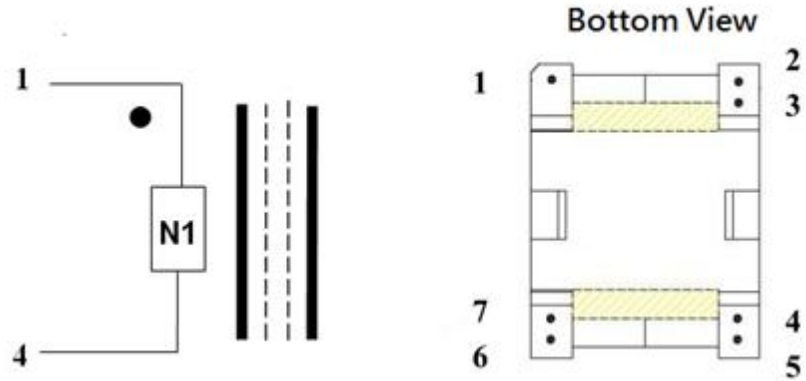

Figure 9. Transformer Specifications & Construction

Table 4. Winding Specifications

No.	Winding	Pin (S → F)	Wire	Turns	Winding Method
1	N1	1 → 6, 7	0.2φ×35 *1	25	Solenoid Winding
2	Insulation: Polyester Tape t = 0.025 mm, 2-Layer				
3	Copper-Foil 1.2T to PIN4, 5				

Table 5. Electrical Characteristics

	Pin	Specifications
Inductance	1 → 6, 7	100 μH ± 5%

7.4. L11 Specification

- Core: Ferrite core DRWW 6x10(6ψ*10 mm)
- Bobbin: 2 Pins

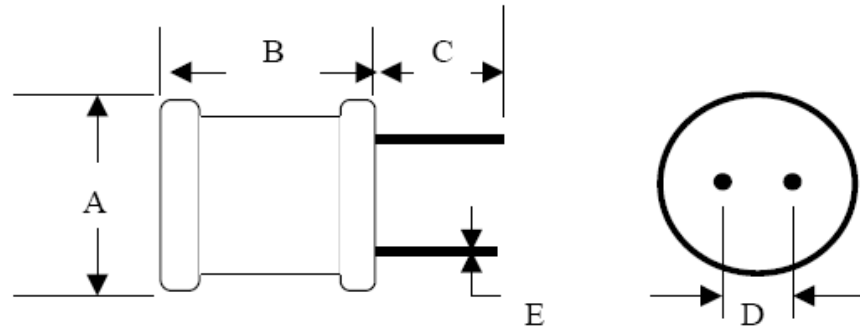

Figure 10. Transformer Specifications & Construction

Table 6. Winding Specifications

No.	Winding	Pin (S → F)	Wire	Turns	Winding Method
1	N1	1 → 2	0.55 mm	18	Solenoid Winding
2	Ferrite core DRWW 6x10 (6ψ*10 mm)				

Table 7. Electrical Characteristics

	Pin	Specifications
Inductance	1 - 2	10 μH ± 5%

8. Test Conditions & Test Equipment

8.1. Features

Table 8. Test Conditions & Test Equipment

Test Mode	FEBFAN9673Q_B1H5000A
Test Date	Nov.4, 2013
Test Temperature	Ambient 25°C
Test Equipment	AC Source: EXTECH 6220 AC/DC Electronic Load: Chroma 63020 Power Meter: HIOKI 3390 Oscilloscope: Lecroy Wavesurfer 424
Test Items	1. AC Trim Up & Trim Down 2. PFC ON/OFF & RDY 3. Ripple & Noise 4. Efficiency 5. Current Harmonic

8.2. Test Procedure

Before powering up the board, verify that the AC voltage source is connected to line input terminals on the evaluation board and the AC-DC electronic load is connected to the PFC output.

1. Set the electronic load to no-load or light-load condition and apply the AC voltage across the input of the evaluation board.
2. When the AC voltage (180~264 V_{AC}) is supplied to the board, the FAN9673 begins normal operation and the on-board flyback converter provides the 12 V_{SB} output. The Flyback transformer's auxiliary winding supplies the V_{DD} voltage for the FAN9673 to power up the PFC stage.
3. PFC startup is controlled by the V_{EA} level. Prior to the soft-start voltage reaching 6 V, the V_{EA} level is limited by soft start.
4. After the bulk capacitor or PFC output voltage reaches the steady-state value, 392 V, the load condition of the electronic load can be changed to test system performance.

Hint:

1. It is recommended that an external fan be added to help dissipate the heat on the NTC, IGBT, diode, and bridge on the evaluation board.

9. Performance of Evaluation Board

9.1. AC Trim Up & Trim Down

Test Condition:

Switch the input voltage from 180 V to 264 V or from 264 V to 180 V, the output voltages should be normal and the output of PFC bus should be less than 450 V.

Test Result:

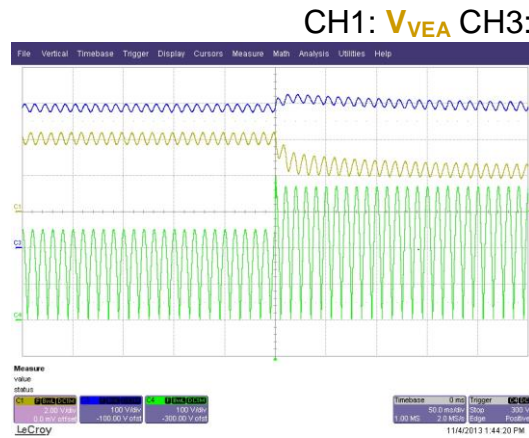

Figure 11. 180 V→264 V 5000 W Load

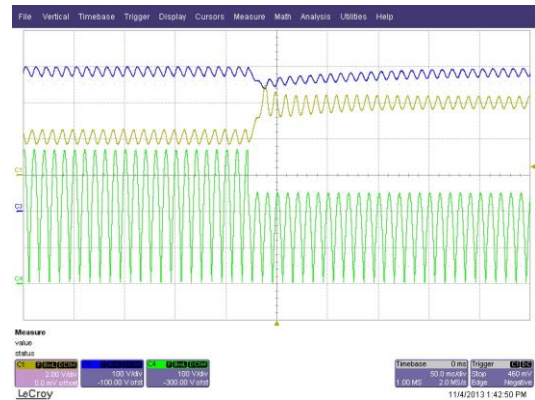

Figure 12. 264 V→180 V 5000 W Load

9.2. PFC ON / OFF & RDY

Test Result:

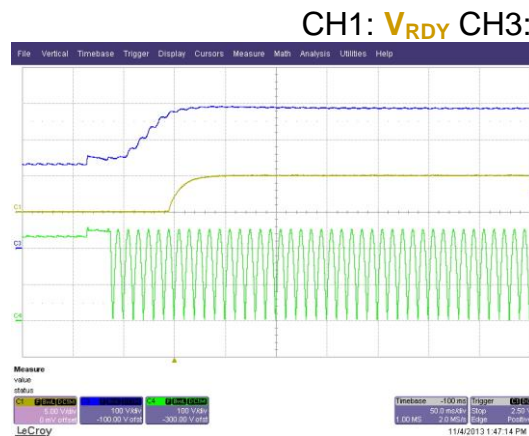

Figure 13. PFC ON

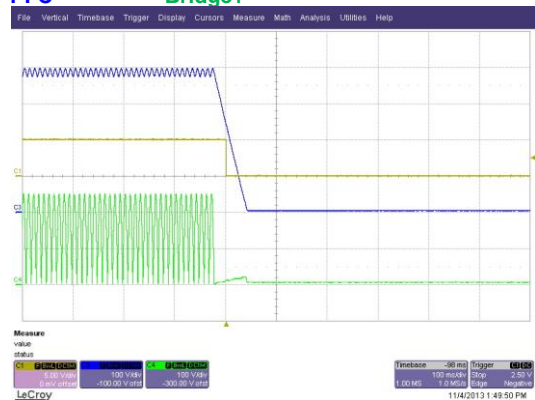

Figure 14. PFC OFF

9.3. Ripple & Noise

Test Result:

CH3: V_{PFC}

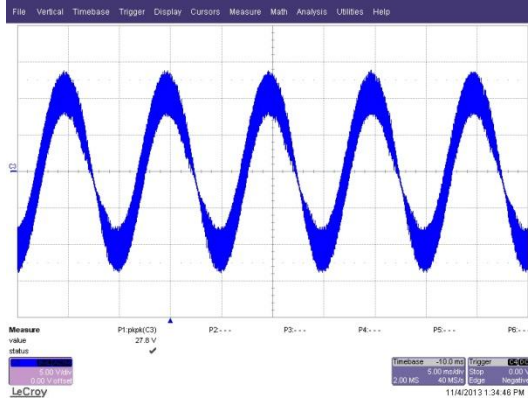

Figure 15. 180 V / 50 Hz

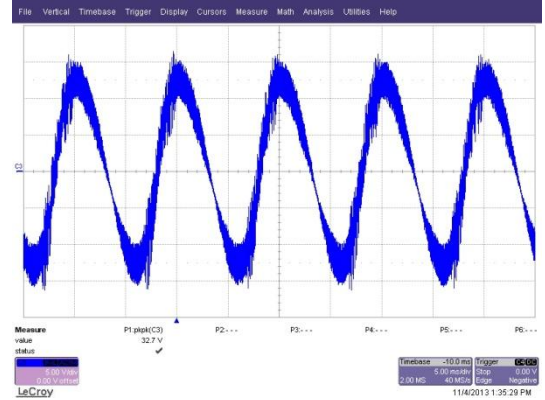

Figure 16. 264 V / 50 Hz

9.4. Efficiency

Test Condition:

Measure efficiency at min., mid., and max. loading.

Test Result:

FAN9673	Input Watts (W)	Output Watts (W)	Efficiency
A. $V_{IN}=180$ V at 25% Load	1295	1250	96.5%
B. $V_{IN}=180$ V at 50% Load	2590	2500	96.5%
C. $V_{IN}=180$ V at 75% Load	3885	3750	96.5%
D. $V_{IN}=180$ V at 100% Load	5195	5000	96.2%
E. $V_{IN}=220$ V at 25% Load	1288	1250	97.0%
F. $V_{IN}=220$ V at 50% Load	2573	2500	97.1%
G. $V_{IN}=220$ V at 75% Load	3856	3750	97.2%
H. $V_{IN}=220$ V at 100% Load	5149	5000	97.1%
I. $V_{IN}=264$ V at 25% Load	1280	1250	97.6%
J. $V_{IN}=264$ V at 50% Load	2553	2500	97.9%
K. $V_{IN}=264$ V at 75% Load	3836	3750	97.7%
L. $V_{IN}=264$ V at 100% Load	5122	5000	97.6%

9.5. Current Harmonic

Test Results:

FAN9673			
Input Voltage	Condition	PF	THD (%)
180 V / 50 Hz	25% Load	0.9912	10.55
	50% Load	0.9947	9.17
	75% Load	0.9971	6.62
	100% Load	0.9974	6.40
220 V / 50 Hz	25% Load	0.9800	14.32
	50% Load	0.9868	14.36
	75% Load	0.9905	12.55
	100% Load	0.9924	11.26
264 V / 50 Hz	25% Load	0.9365	25.85
	50% Load	0.9369	33.22
	75% Load	0.9526	29.59
	100% Load	0.9600	27.29

180 V / 50 Hz Input Current Waveform & Harmonic

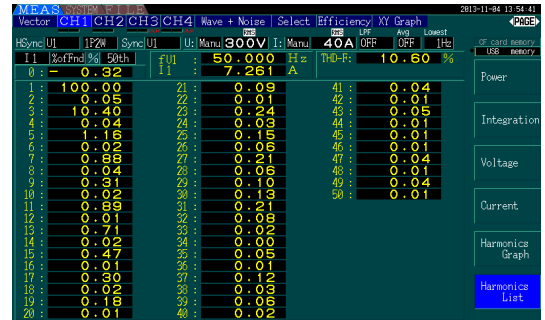
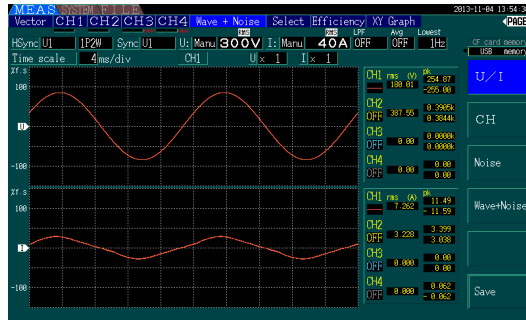

Figure 17. 25% Load

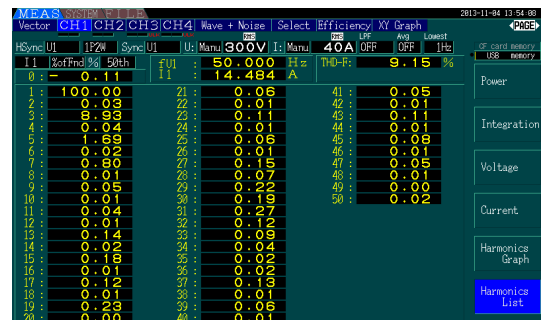
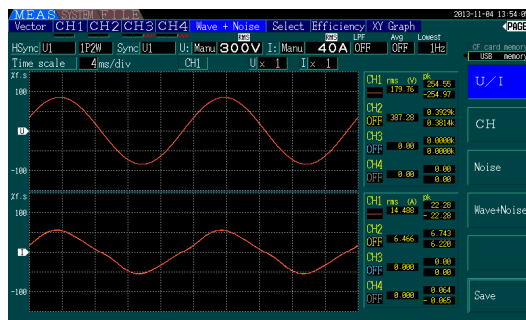

Figure 18. 50% Load

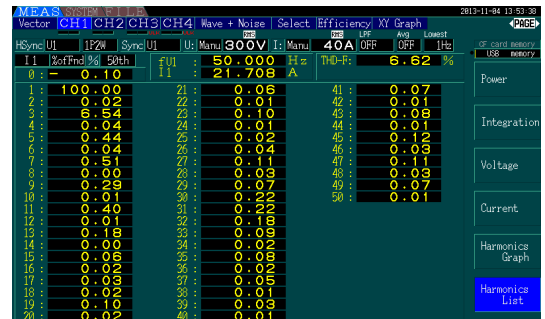
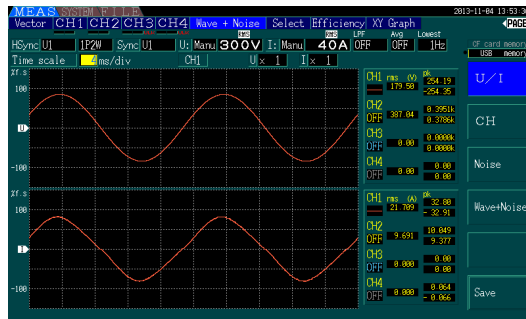

Figure 19. 75% Load

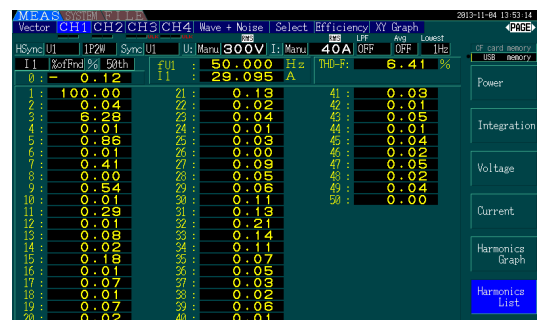
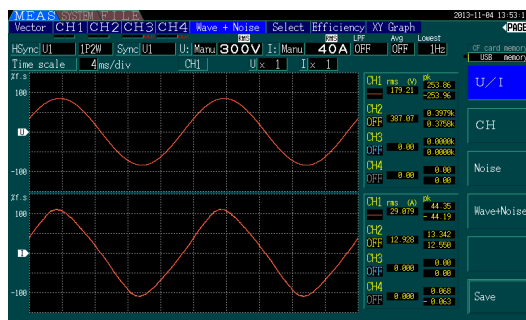

Figure 20. 100% Load



220 V / 50 Hz Input Current Waveform & Harmonic

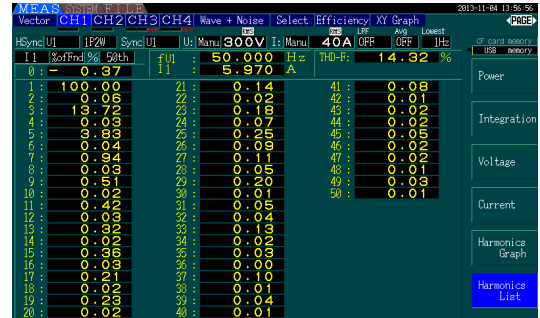
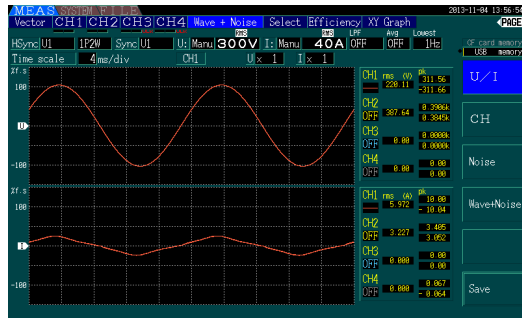

Figure 21. 25% Load

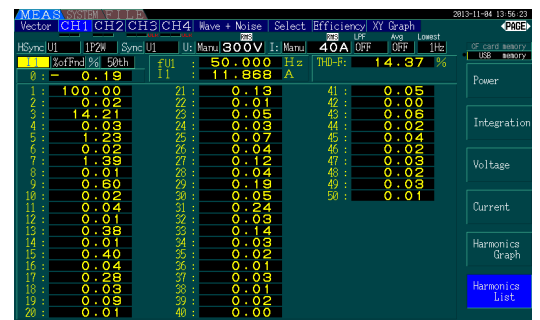
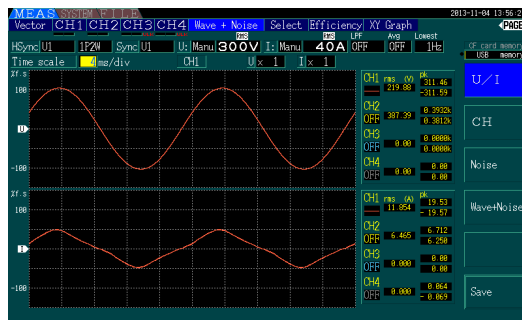

Figure 22. 50% Load

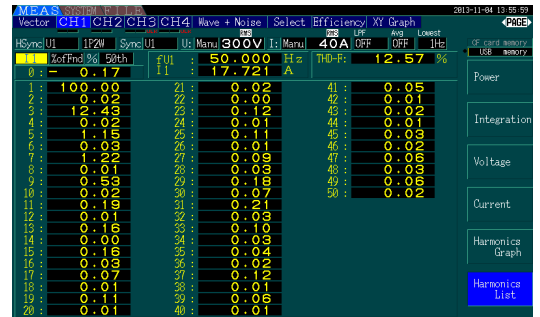
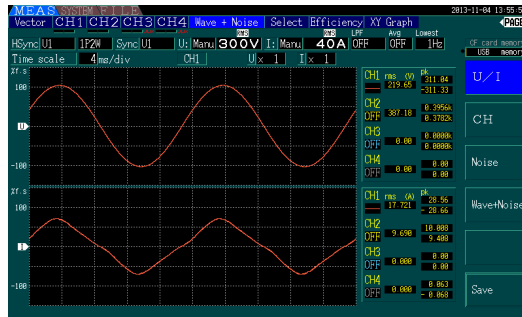

Figure 23. 75% Load

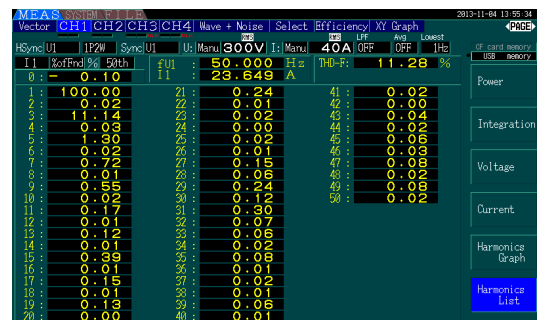
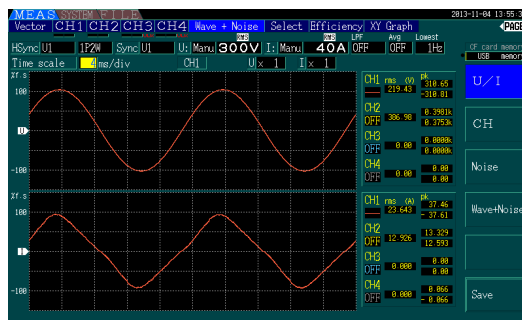

Figure 24. 100% Load



264 V / 50 Hz Input Current Waveform & Harmonic

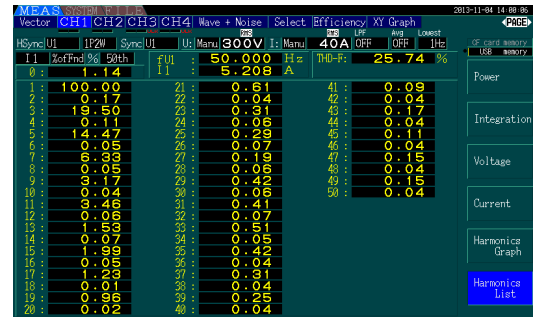
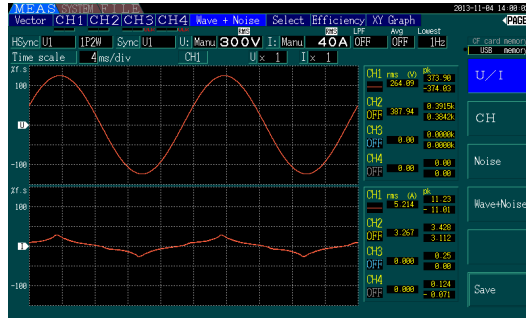

Figure 25. 25% Load

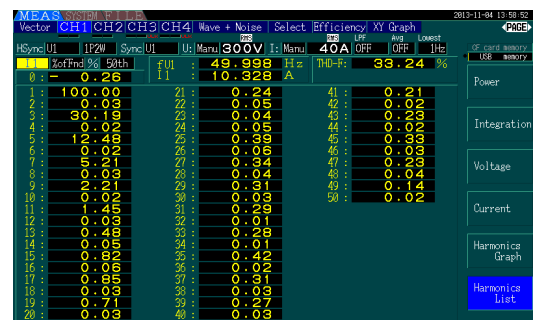
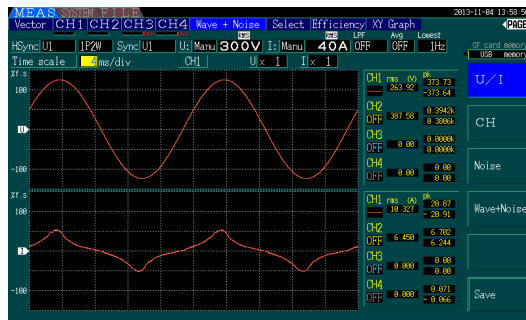

Figure 26. 50% Load

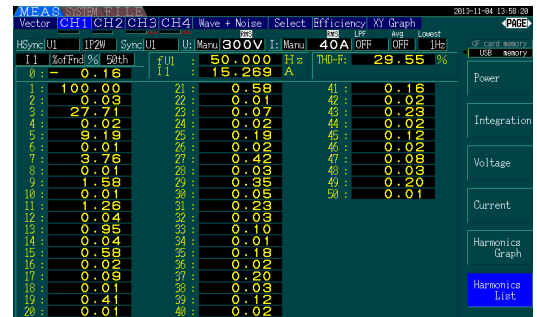
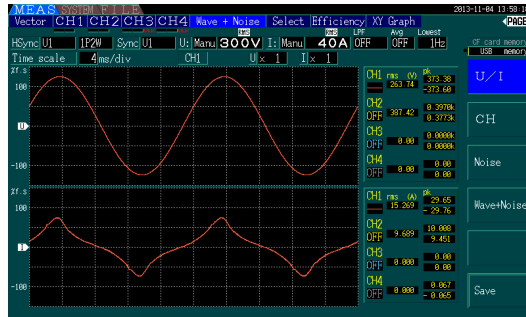

Figure 27. 75% Load

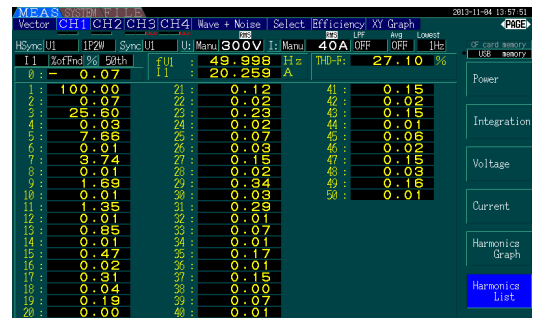
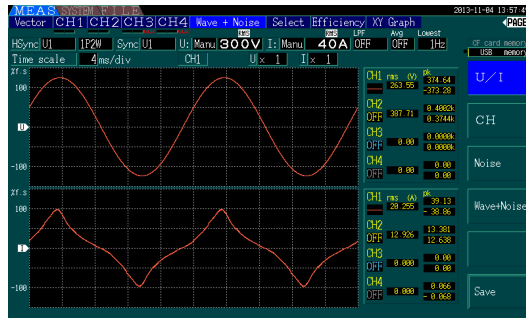

Figure 28. 100% Load

10. Notice Letter

To properly operate the high-power interleaved CCM PFC evaluation board, cooling fans must be enabled to remove the heat from switching IGBTs and diodes. The fans are usually set up as shown in the following picture.

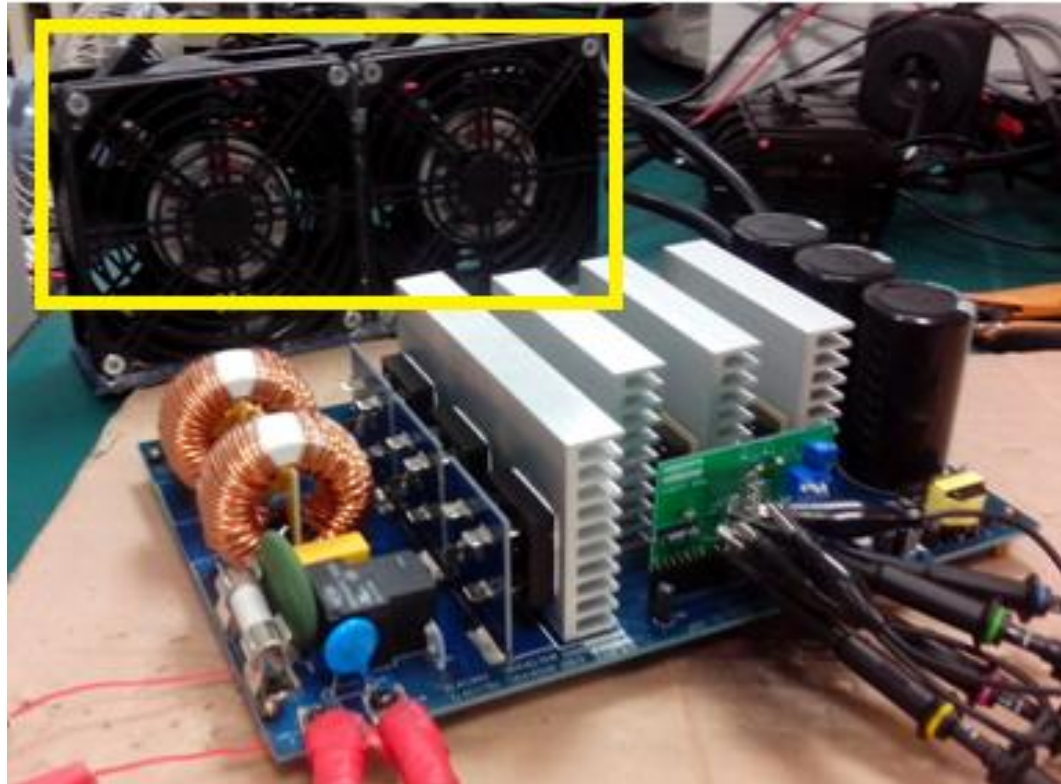

Figure 29. Recommended Fan Setup

Note:

2. Fans are not provided with the evaluation board. Supply fans for testing.

11. Safety Precautions



Before applying power to the FEBFAN9673Q_B1H5000A evaluation board, it is imperative that all involved personnel read and understand the safety precautions and understand the power on/off procedures.

The FEBFAN9673Q_B1H5000A evaluation board operates at lethal voltages and has bulk capacitors that store significant charge. Accidental contact can lead to lab equipment damage, personnel injury, and may be fatal. Be exceptionally careful when probing and handling this board. Always observe normal laboratory precautions, including:

- A. All connected computers and measurement equipment **MUST** be isolated from the AC mains before operating voltages are applied to the board. Alternatively, AC/DC power to the board may be isolated.
- B. When using an oscilloscope with this board, it must be isolated from the AC line. Alternatively, high-voltage (700 V+) isolated probes may be utilized.
- C. Start with a clean working surface, clear of any conductive material.
- D. Be careful while turning on the power switch to the AC source.
- E. Never probe or move a probe on the board while the AC line voltage is present.
- F. Ensure the bulk capacitors are discharged before disconnecting the high power load.

Note:

3. Even when a computer is isolated from AC mains through external supply, a connection to earth-potential may exist through LAN, VGA, or other connections to peripherals.



12. Revision History

Rev.	Date	Description
1.0.0	Jan 2014	Initial release
1.0.1	April 2014	Update to BOM
1.0.2	July 2014	Update to BOM
1.3	March 2014	Updated Part number to FEBFAN9673Q_B1H5000A

WARNING AND DISCLAIMER

Replace components on the Evaluation Board only with those parts shown on the parts list (or Bill of Materials) in the Users' Guide. Contact an authorized Fairchild representative with any questions.

This board is intended to be used by certified professionals, in a lab environment, following proper safety procedures. Use at your own risk. The Evaluation board (or kit) is for demonstration purposes only and neither the Board nor this User's Guide constitute a sales contract or create any kind of warranty, whether express or implied, as to the applications or products involved. Fairchild warrants that its products meet Fairchild's published specifications, but does not guarantee that its products work in any specific application. Fairchild reserves the right to make changes without notice to any products described herein to improve reliability, function, or design. Either the applicable sales contract signed by Fairchild and Buyer or, if no contract exists, Fairchild's standard Terms and Conditions on the back of Fairchild invoices, govern the terms of sale of the products described herein.

DISCLAIMER

FAIRCHILD SEMICONDUCTOR RESERVES THE RIGHT TO MAKE CHANGES WITHOUT FURTHER NOTICE TO ANY PRODUCTS HEREIN TO IMPROVE RELIABILITY, FUNCTION, OR DESIGN. FAIRCHILD DOES NOT ASSUME ANY LIABILITY ARISING OUT OF THE APPLICATION OR USE OF ANY PRODUCT OR CIRCUIT DESCRIBED HEREIN; NEITHER DOES IT CONVEY ANY LICENSE UNDER ITS PATENT RIGHTS, NOR THE RIGHTS OF OTHERS.

LIFE SUPPORT POLICY

FAIRCHILD'S PRODUCTS ARE NOT AUTHORIZED FOR USE AS CRITICAL COMPONENTS IN LIFE SUPPORT DEVICES OR SYSTEMS WITHOUT THE EXPRESS WRITTEN APPROVAL OF THE PRESIDENT OF FAIRCHILD SEMICONDUCTOR CORPORATION.

As used herein:

1. Life support devices or systems are devices or systems which, (a) are intended for surgical implant into the body, or (b) support or sustain life, or (c) whose failure to perform when properly used in accordance with instructions for use provided in the labeling, can be reasonably expected to result in significant injury to the user.
2. A critical component is any component of a life support device or system whose failure to perform can be reasonably expected to cause the failure of the life support device or system, or to affect its safety or effectiveness.

ANTI-COUNTERFEITING POLICY

Fairchild Semiconductor Corporation's Anti-Counterfeiting Policy. Fairchild's Anti-Counterfeiting Policy is also stated on our external website, www.fairchildsemi.com, under Sales Support.

Counterfeiting of semiconductor parts is a growing problem in the industry. All manufacturers of semiconductor products are experiencing counterfeiting of their parts. Customers who inadvertently purchase counterfeit parts experience many problems such as loss of brand reputation, substandard performance, failed applications, and increased cost of production and manufacturing delays. Fairchild is taking strong measures to protect ourselves and our customers from the proliferation of counterfeit parts. Fairchild strongly encourages customers to purchase Fairchild parts either directly from Fairchild or from Authorized Fairchild Distributors who are listed by country on our web page cited above. Products customers buy either from Fairchild directly or from Authorized Fairchild Distributors are genuine parts, have full traceability, meet Fairchild's quality standards for handling and storage and provide access to Fairchild's full range of up-to-date technical and product information. Fairchild and our Authorized Distributors will stand behind all warranties and will appropriately address any warranty issues that may arise. Fairchild will not provide any warranty coverage or other assistance for parts bought from Unauthorized Sources. Fairchild is committed to combat this global problem and encourage our customers to do their part in stopping this practice by buying direct or from authorized distributors.

EXPORT COMPLIANCE STATEMENT

These commodities, technology, or software were exported from the United States in accordance with the Export Administration Regulations for the ultimate destination listed on the commercial invoice. Diversion contrary to U.S. law is prohibited.

U.S. origin products and products made with U.S. origin technology are subject to U.S. Re-export laws. In the event of re-export, the user will be responsible to ensure the appropriate U.S. export regulations are followed.

Mouser Electronics

Authorized Distributor

Click to View Pricing, Inventory, Delivery & Lifecycle Information:

[ON Semiconductor:](#)

[FEBFAN9673Q_B1H5000A](#) [FEBFAN9673Q-B1H5000A-GEVB](#)

Компания «Океан Электроники» предлагает заключение долгосрочных отношений при поставках импортных электронных компонентов на взаимовыгодных условиях!

Наши преимущества:

- Поставка оригинальных импортных электронных компонентов напрямую с производств Америки, Европы и Азии, а так же с крупнейших складов мира;
- Широкая линейка поставок активных и пассивных импортных электронных компонентов (более 30 млн. наименований);
- Поставка сложных, дефицитных, либо снятых с производства позиций;
- Оперативные сроки поставки под заказ (от 5 рабочих дней);
- Экспресс доставка в любую точку России;
- Помощь Конструкторского Отдела и консультации квалифицированных инженеров;
- Техническая поддержка проекта, помощь в подборе аналогов, поставка прототипов;
- Поставка электронных компонентов под контролем ВП;
- Система менеджмента качества сертифицирована по Международному стандарту ISO 9001;
- При необходимости вся продукция военного и аэрокосмического назначения проходит испытания и сертификацию в лаборатории (по согласованию с заказчиком);
- Поставка специализированных компонентов военного и аэрокосмического уровня качества (Xilinx, Altera, Analog Devices, Intersil, Interpoint, Microsemi, Actel, Aeroflex, Peregrine, VPT, Syfer, Eurofarad, Texas Instruments, MS Kennedy, Miteq, Cobham, E2V, MA-COM, Hittite, Mini-Circuits, General Dynamics и др.);

Компания «Океан Электроники» является официальным дистрибьютором и эксклюзивным представителем в России одного из крупнейших производителей разъемов военного и аэрокосмического назначения «JONHON», а так же официальным дистрибьютором и эксклюзивным представителем в России производителя высокотехнологичных и надежных решений для передачи СВЧ сигналов «FORSTAR».



JONHON

«JONHON» (основан в 1970 г.)

Разъемы специального, военного и аэрокосмического назначения:

(Применяются в военной, авиационной, аэрокосмической, морской, железнодорожной, горно- и нефтедобывающей отраслях промышленности)

«FORSTAR» (основан в 1998 г.)

ВЧ соединители, коаксиальные кабели, кабельные сборки и микроволновые компоненты:

(Применяются в телекоммуникациях гражданского и специального назначения, в средствах связи, РЛС, а так же военной, авиационной и аэрокосмической отраслях промышленности).



Телефон: 8 (812) 309-75-97 (многоканальный)

Факс: 8 (812) 320-03-32

Электронная почта: ocean@oceanchips.ru

Web: <http://oceanchips.ru/>

Адрес: 198099, г. Санкт-Петербург, ул. Калинина, д. 2, корп. 4, лит. А