

## 25 W + 25 W stereo amplifier with mute and standby

### Features

- Wide supply voltage range (up to  $\pm 22.5$  V)
- Split supply
- High output power
  - 25 W + 25 W into 8  $\Omega$
  - with  $V_S = \pm 20$  V and THD = 10%
- No “pop” at turn on/off
- Mute (“pop”-free)
- Standby feature (low  $I_Q$ )
- Few external components
- Short-circuit protection
- Thermal overload protection

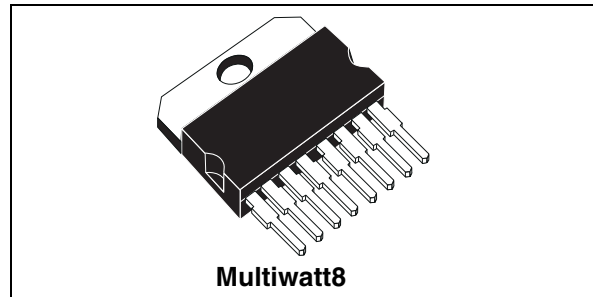

### Description

The TDA7264 is class-AB dual audio power amplifier assembled in a Multiwatt package.

It is specially designed for high-quality sound applications such as hi-fi music centers and stereo TV sets.

**Table 1. Device summary**

Order code	Operating temperature	Package	Packaging
TDA7264	0 to 70 °C	Multiwatt8	Tube

**Figure 1. Applications circuit**

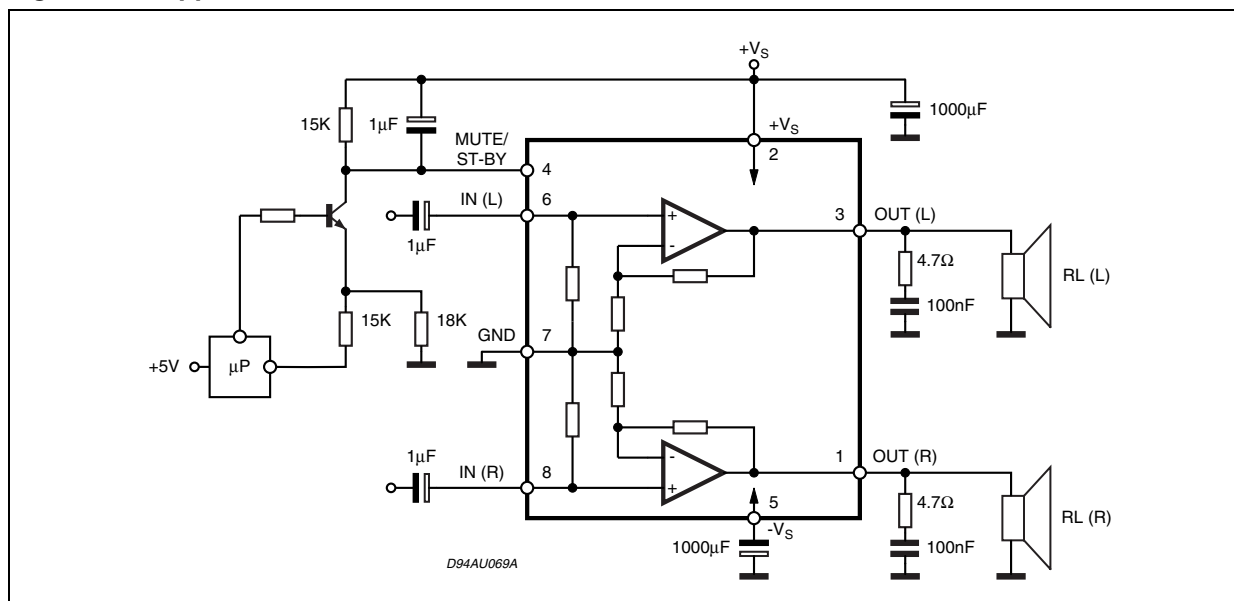

# 1 Pin description

Figure 2. Pin connection (top view)

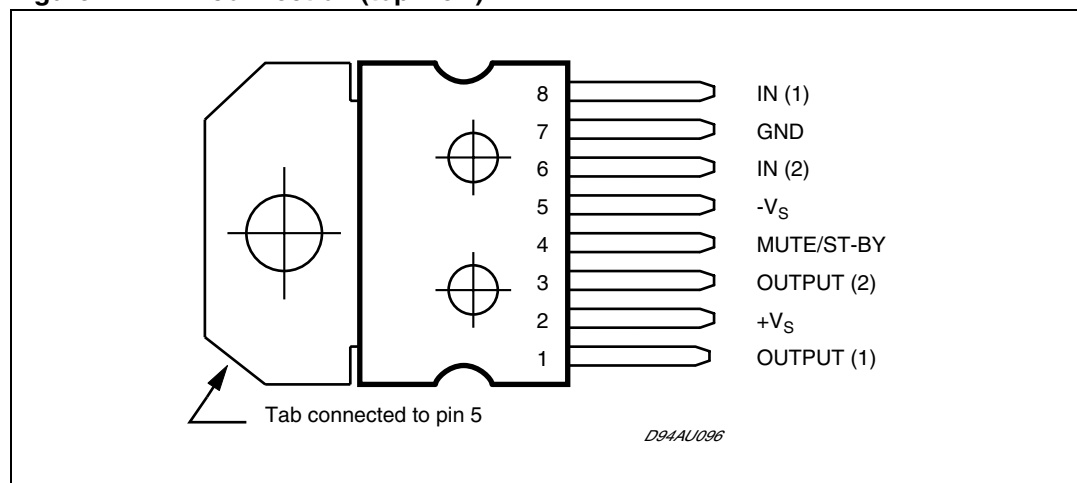

## 2 Electrical specifications

### 2.1 Absolute maximum ratings

Table 2. Absolute maximum ratings

Symbol	Parameter	Value	Unit
$V_S$	DC supply voltage	$\pm 25$	V
$I_O$	Output Peak Current (internally limited)	4.5	A
$P_{tot}$	power Dissipation $T_{case} = 70^\circ\text{C}$	30	W
$T_{op}$	Operating temperature	-20 to 85	$^\circ\text{C}$
$T_j$	Junction temperature	-40 to 150	$^\circ\text{C}$
$T_{stg}$	Storage temperature	-40 to 150	$^\circ\text{C}$

### 2.2 Thermal data

Table 3. Thermal data

Symbol	Parameter	Min	Typ	Max	Unit
$R_{th\ j-case}$	Thermal resistance, junction to case	-	-	2	$^\circ\text{C/W}$

### 2.3 Electrical specifications

Unless otherwise stated, the results in [Table 4](#) below are given for the conditions:  $V_S = \pm 20\text{ V}$ ,  $R_L$  (load) = 8  $\Omega$ ,  $R_S$  (source) = 50  $\Omega$ ,  $f = 1\text{ kHz}$ , and  $T_{amb} = 25^\circ\text{C}$ . See also the applications circuit in [Figure 12 on page 9](#).

Table 4. Electrical specifications

Symbol	Parameter	Conditions	Min	Typ	Max	Unit
$V_S$	Supply voltage range	-	$\pm 5$	-	$\pm 22.5$	V
$I_q$	Total quiescent current	-	-	80	130	mA
$P_{OM}$	Music output power <sup>(1)</sup>	THD = 10%, $R_L = 8\ \Omega$ , $V_S = \pm 22.5\text{ V}$	-	32	-	W
$P_O$	Output power	THD = 10%: $R_L = 8\ \Omega$ , $V_S = \pm 20\text{ V}$ $R_L = 4\ \Omega$ , $V_S = \pm 16\text{ V}$	20	25 25	-	W
		THD = 1%: $R_L = 8\ \Omega$ , $V_S = \pm 20\text{ V}$ $R_L = 4\ \Omega$ , $V_S = \pm 16\text{ V}$	-	20 20	-	

**Table 4. Electrical specifications (continued)**

Symbol	Parameter	Conditions	Min	Typ	Max	Unit
THD	Total harmonic distortion	$P_O = 1\text{ W}$ , $f = 1\text{ kHz}$ , $R_L = 8\ \Omega$ , $V_S = \pm 20\text{ V}$ ,	-	0.02	-	%
		$P_O = 0.1\text{ to }15\text{ W}$ , $f = 100\text{ Hz to }15\text{ kHz}$ , $R_L = 8\ \Omega$ , $V_S = \pm 20\text{ V}$	-	-	0.5	
		$P_O = 1\text{ W}$ , $f = 1\text{ kHz}$ , $R_L = 4\ \Omega$ , $V_S = \pm 16\text{ V}$ ,	-	0.03	-	
		$P_O = 0.1\text{ to }12\text{ W}$ , $f = 100\text{ Hz to }15\text{ kHz}$ , $R_L = 4\ \Omega$ , $V_S = \pm 16\text{ V}$	-	-	1.0	
$C_T$	Crosstalk	$f = 1\text{ kHz}$ $f = 10\text{ kHz}$	-	70 60	-	dB
SR	Slew rate	-	-	10	-	V/ $\mu$ s
$G_V$	Closed-loop voltage gain	-	29	30	31	dB
$\Delta G_V$	Voltage gain matching	-	-	0.2	-	dB
eN	Total input noise	A curve $f = 20\text{ Hz to }22\text{ kHz}$	-	2.5 3.5	8 -	$\mu$ V
$R_i$	Input resistance	-	15	20	-	k $\Omega$
SVRR	Supply voltage rejection ratio	$f_r = 100\text{ Hz}$ , $V_r = 0.5\text{ V}$	-	60	-	dB
$T_j$	Junction temperature at thermal shut-down	-	-	145	-	$^{\circ}$ C
Mute mode (see also <a href="#">Table 5 on page 8</a> )						
$V_{T\_MUTE}$	Mute/play threshold	-	-7	-6	-5	V
$A_{MUTE}$	Mute attenuation	-	60	90	-	dB
Standby mode (see also <a href="#">Table 5 on page 8</a> )						
$V_{T\_STBY}$	Standby/mute threshold	-	-3.5	-2.5	-1.5	V
$A_{STBY}$	Standby attenuation	-	-	110	-	dB
$I_{q\_STBY}$	Quiescent current in standby	-	-	3	-	mA

1. FULL POWER up to  $V_S = \pm 22.5\text{ V}$  with  $R_L = 8\ \Omega$  and  $V_S = \pm 16\text{ V}$  with  $R_L = 4\ \Omega$ .  
MUSIC POWER is the maximum power which the amplifier is capable of producing across the rated load resistance (regardless of non-linearity) 1 s after the application of a sinusoidal input signal of frequency 1 kHz.

### 3 Characterization curves

Figure 3. Quiescent current vs Supply Voltage

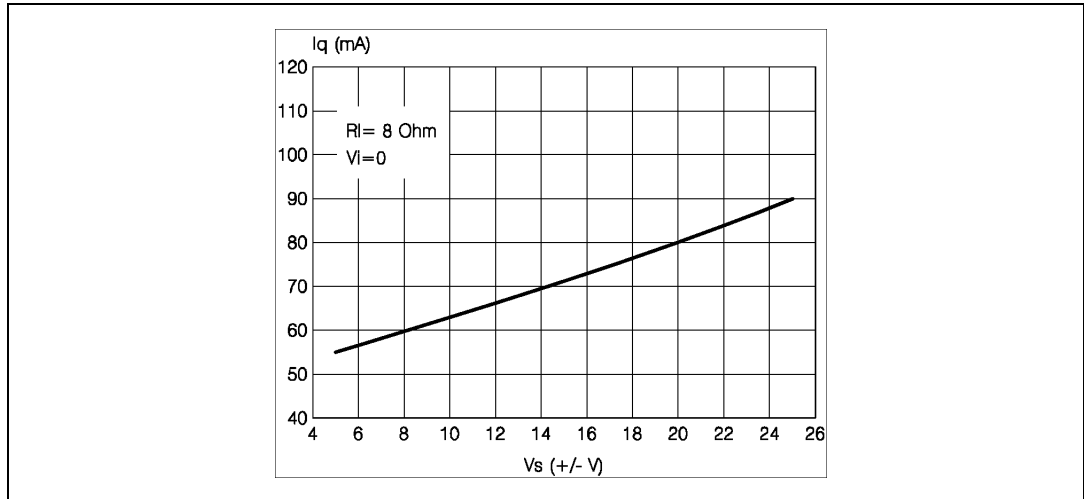
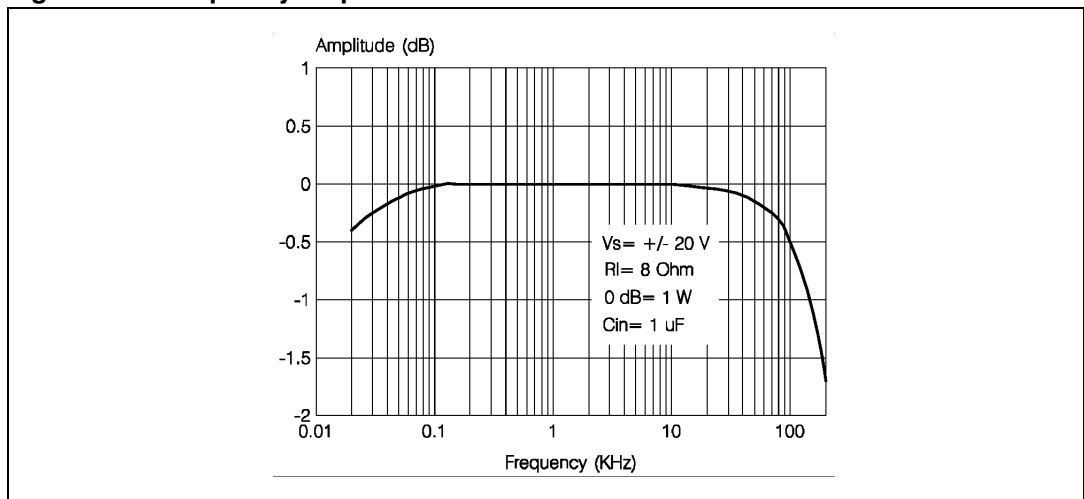
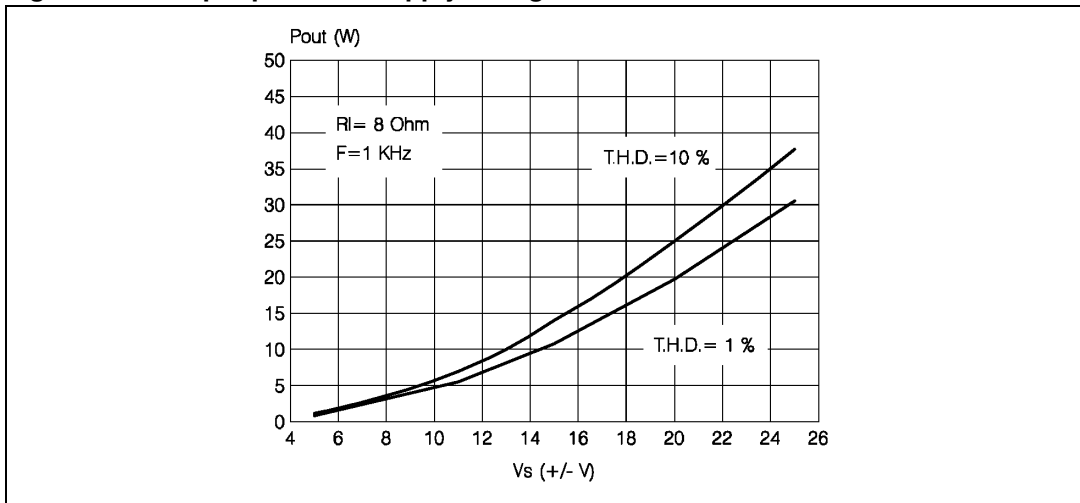

Figure 4. Frequency response



**Figure 5. Output power vs supply voltage**



**Figure 6. Distortion vs output power**

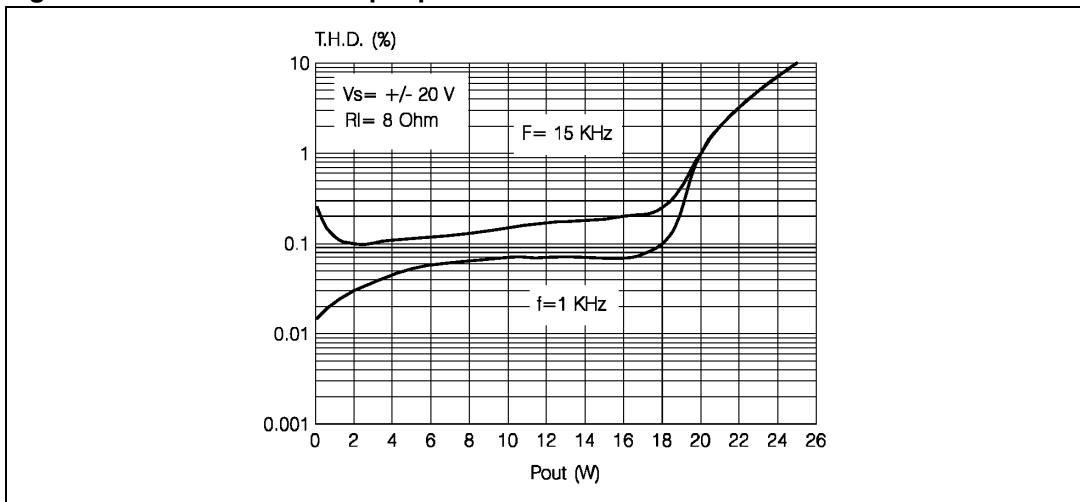

**Figure 7. Crosstalk vs frequency**

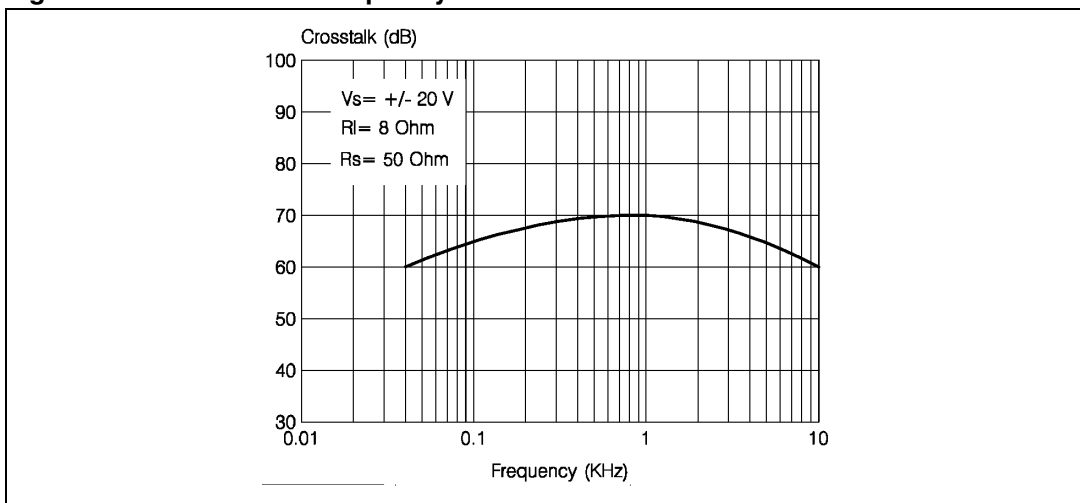

Figure 8. SVRR vs frequency

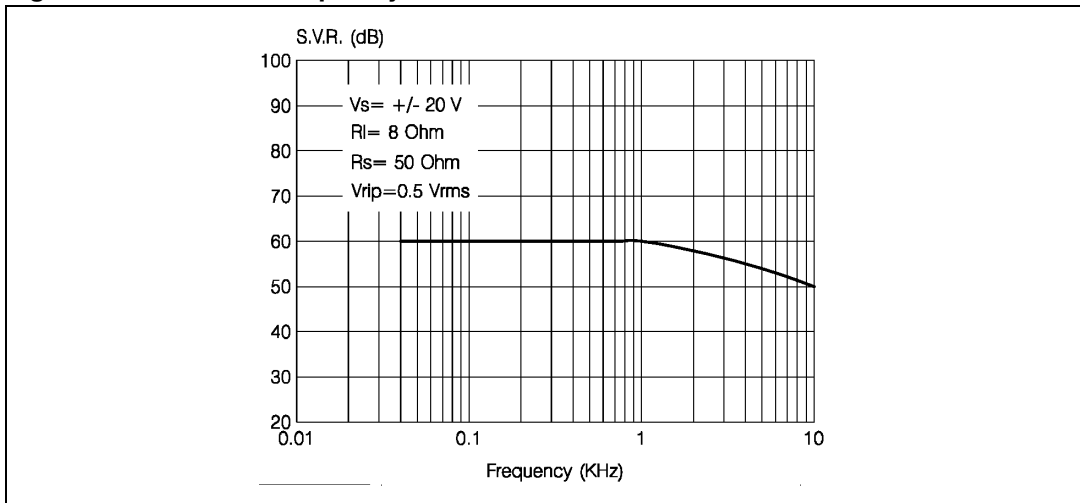

Figure 9. Attenuation and quiescent current vs voltage on pin 4

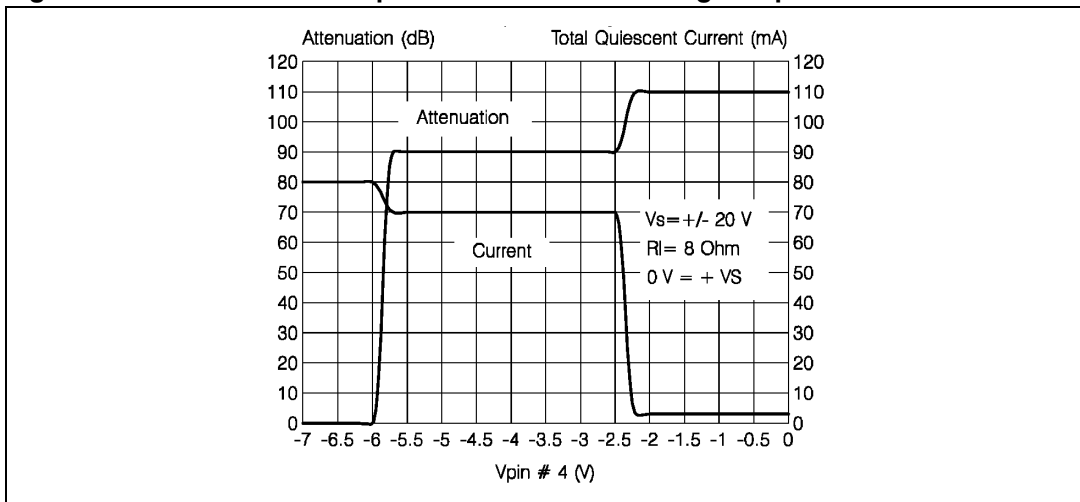
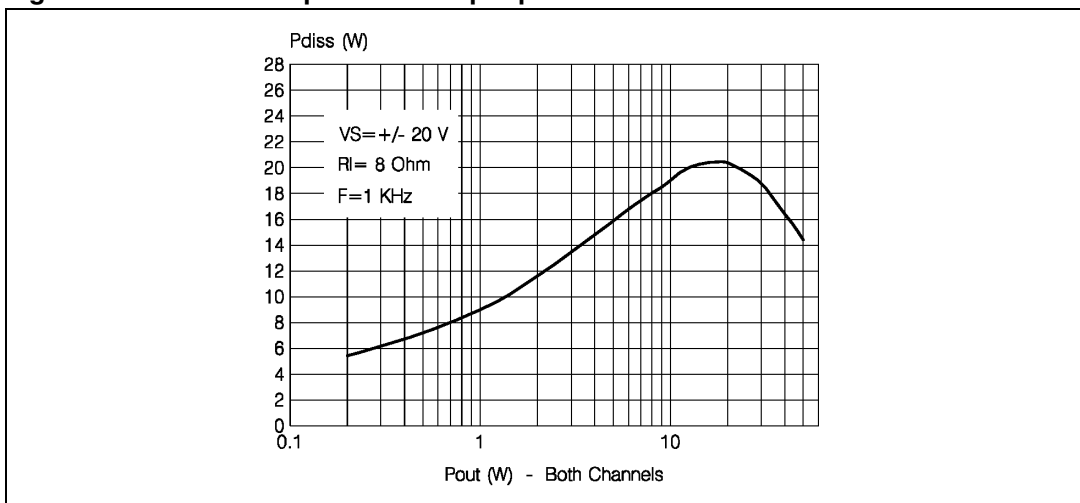

Figure 10. Power dissipation vs output power



## 4 Mute and standby modes

Pin 4 (MUTE/STANDBY) controls the amplifier status by two different thresholds referenced to  $+V_S$  as given in [Table 5](#) below. See also [Table 4: Electrical specifications on page 3](#).

**Table 5. Mute and standby thresholds on pin 5**

Nominal voltage on pin 4, $V_{PIN4}$	Mode	Remarks
$> +V_S - 2.5 \text{ V}$	Standby	Output stages turned off
$> +V_S - 6.0 \text{ V}, < +V_S - 2.5 \text{ V}$	Mute	Output stages turned on, amplifiers muted
$< +V_S - 6.0 \text{ V}$	Play	Amplifiers active

**Figure 11. Mute and standby thresholds on pin 4**

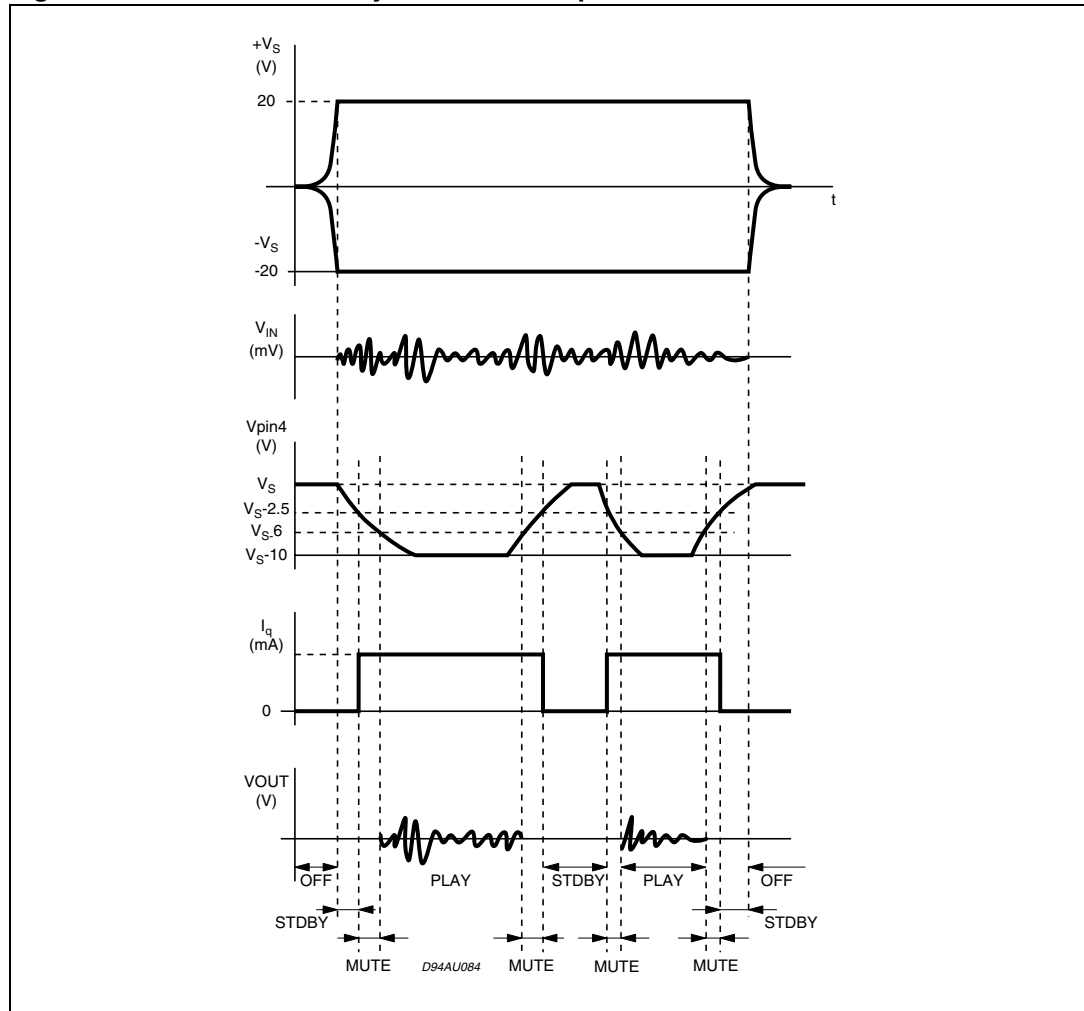



# 5 Applications information

Figure 12. Schematic of demo board

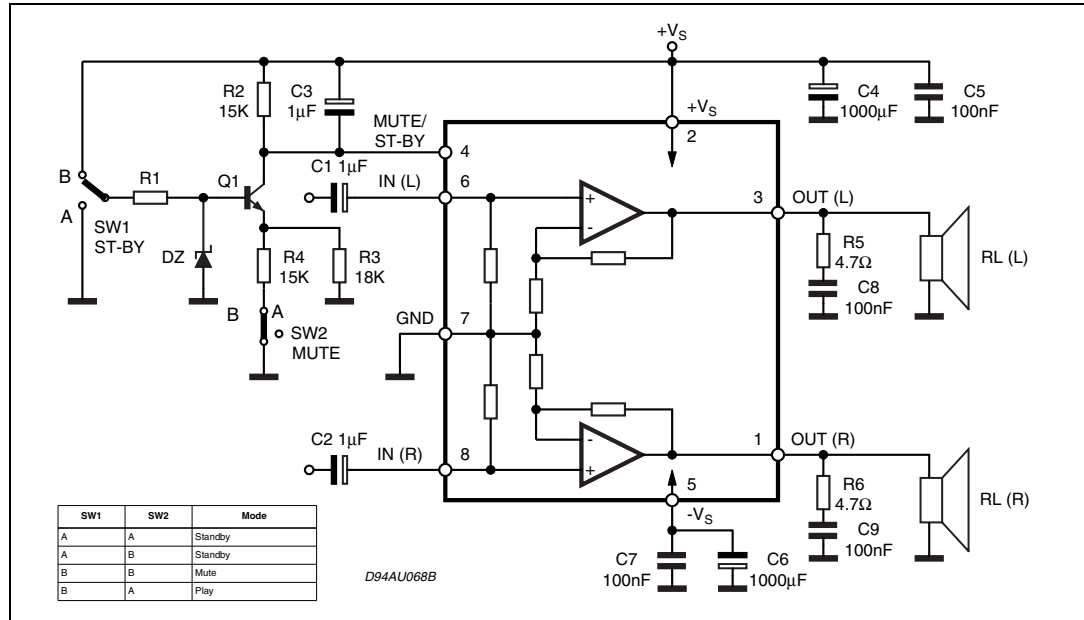
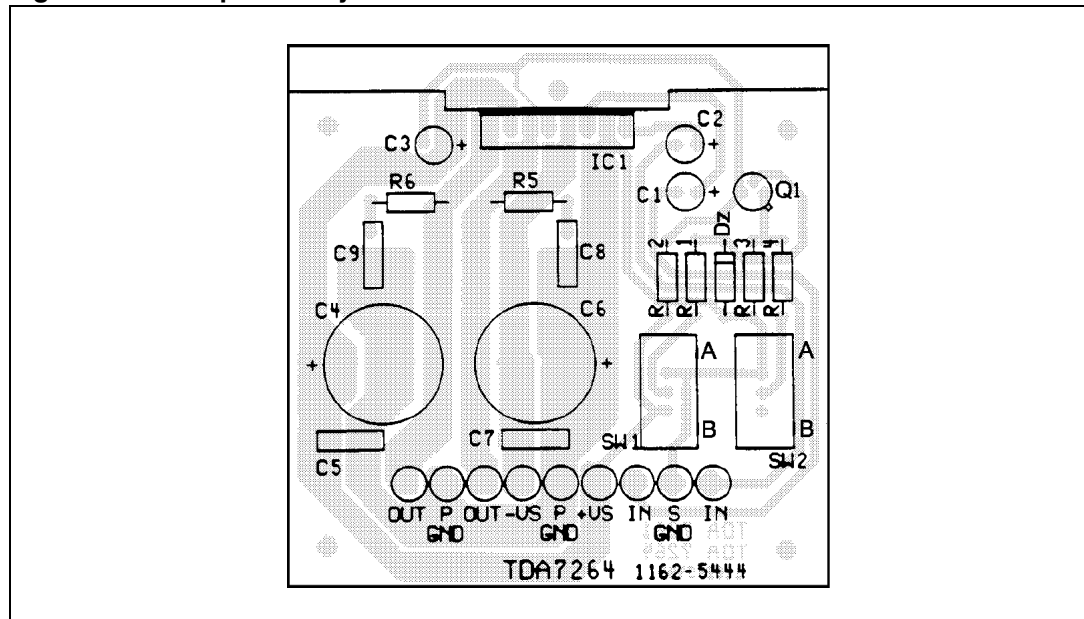

Figure 13. Component layout of demo-board



**Table 6. Recommended component values for demo board**

Component	Recommended value	Purpose	Larger than recommended value	Smaller than recommended value
R1	10 k $\Omega$	Mute circuit	Decrease in DZ biasing current	-
R2	15 k $\Omega$	Mute circuit	V <sub>PIN4</sub> shifted downwards	V <sub>PIN4</sub> shifted upwards
R3	18 k $\Omega$	Mute circuit	V <sub>PIN4</sub> shifted upwards	V <sub>PIN4</sub> shifted downwards
R4	15 k $\Omega$	Mute circuit	V <sub>PIN4</sub> shifted upwards	V <sub>PIN4</sub> shifted downwards
R5, R6	4.7 $\Omega$	Frequency stability	Danger of oscillation	Danger of oscillation
C1, C2	1 $\mu$ F	Input AC coupling	-	Higher low-frequency cutoff
C3	1 $\mu$ F	Standby/mute time constant	Longer on/off time	Shorter on/off time
C4, C6	1000 $\mu$ F	Supply voltage decoupling	-	Danger of oscillation
C5, C7	0.1 $\mu$ F	Supply voltage decoupling	-	Danger of oscillation
C8, C9	0.1 $\mu$ F	Frequency stability	-	-
Dz	5.1 V	Mute circuit	-	-
Q1	BC107	Mute circuit	-	-

## 6 Package mechanical data

The TDA7264 comes in a 8-pin Multiwatt package with pin 5 internally connected to the metal tab.

**Figure 14. Multiwatt8 outline drawing**

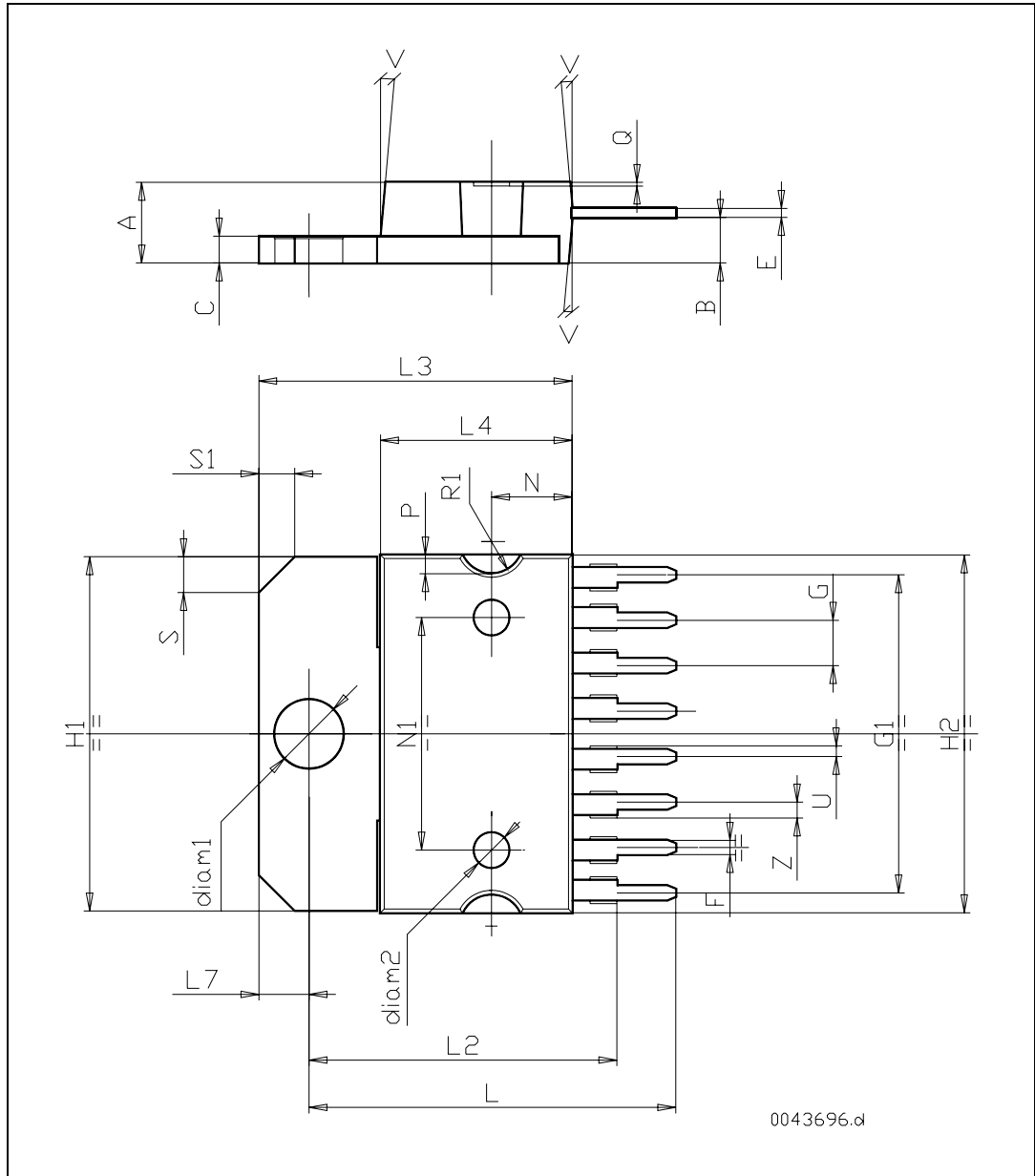

In order to meet environmental requirements, ST offers these devices in different grades of ECOPACK® packages, depending on their level of environmental compliance. ECOPACK® specifications, grade definitions and product status are available at: [www.st.com](http://www.st.com). ECOPACK® is an ST trademark.

Table 7. Multiwatt8 package dimensions

Reference	Dimensions in mm			Dimensions in inches		
	Min	Typ	Max	Min	Typ	Max
A	-	-	5.00	-	-	0.197
B	-	-	2.65	-	-	0.104
C	-	-	1.60	-	-	0.063
E	0.49	-	0.55	0.019	-	0.22
F	0.78	-	0.85	0.031	-	0.033
G	2.40	2.54	2.68	0.094	0.100	0.106
G1	17.64	17.78	17.92	0.694	0.700	0.706
H1	19.60	-	-	0.772	-	-
H2	-	-	20.20	-	-	0.787
L	20.35	-	20.65	0.801	-	0.813
L2	17.05	17.20	17.35	0.671	0.677	0.683
L3	17.25	17.50	17.75	0.679	0.689	0.699
L4	10.30	10.70	10.90	0.406	0.421	0.429
L7	2.65	-	2.90	0.104	-	0.114
N	-	-	-	-	-	-
N1	-	-	-	-	-	-
P	-	-	-	-	-	-
Q	-	-	-	-	-	-
R1	-	-	-	-	-	-
S	1.90	-	2.60	0.075	-	0.102
S1	1.90	-	2.60	0.075	-	0.102
U	0.40	-	0.55	0.016	-	0.022
V	-	5 deg	-	-	5 deg	-
Z	0.70	-	0.85	-	-	0.033
Diam.1	3.65	-	3.85	0.144	-	0.152
Diam.2	-	-	-	-	-	-

## 7 Revision history

**Table 8. Document revision history**

Date	Revision	Changes
Jan-2004	5	First issue in EDOCS
01-Jul-2009	6	Removed references to TDA7264A

**Please Read Carefully:**

Information in this document is provided solely in connection with ST products. STMicroelectronics NV and its subsidiaries ("ST") reserve the right to make changes, corrections, modifications or improvements, to this document, and the products and services described herein at any time, without notice.

All ST products are sold pursuant to ST's terms and conditions of sale.

Purchasers are solely responsible for the choice, selection and use of the ST products and services described herein, and ST assumes no liability whatsoever relating to the choice, selection or use of the ST products and services described herein.

No license, express or implied, by estoppel or otherwise, to any intellectual property rights is granted under this document. If any part of this document refers to any third party products or services it shall not be deemed a license grant by ST for the use of such third party products or services, or any intellectual property contained therein or considered as a warranty covering the use in any manner whatsoever of such third party products or services or any intellectual property contained therein.

**UNLESS OTHERWISE SET FORTH IN ST'S TERMS AND CONDITIONS OF SALE ST DISCLAIMS ANY EXPRESS OR IMPLIED WARRANTY WITH RESPECT TO THE USE AND/OR SALE OF ST PRODUCTS INCLUDING WITHOUT LIMITATION IMPLIED WARRANTIES OF MERCHANTABILITY, FITNESS FOR A PARTICULAR PURPOSE (AND THEIR EQUIVALENTS UNDER THE LAWS OF ANY JURISDICTION), OR INFRINGEMENT OF ANY PATENT, COPYRIGHT OR OTHER INTELLECTUAL PROPERTY RIGHT.**

**UNLESS EXPRESSLY APPROVED IN WRITING BY AN AUTHORIZED ST REPRESENTATIVE, ST PRODUCTS ARE NOT RECOMMENDED, AUTHORIZED OR WARRANTED FOR USE IN MILITARY, AIR CRAFT, SPACE, LIFE SAVING, OR LIFE SUSTAINING APPLICATIONS, NOR IN PRODUCTS OR SYSTEMS WHERE FAILURE OR MALFUNCTION MAY RESULT IN PERSONAL INJURY, DEATH, OR SEVERE PROPERTY OR ENVIRONMENTAL DAMAGE. ST PRODUCTS WHICH ARE NOT SPECIFIED AS "AUTOMOTIVE GRADE" MAY ONLY BE USED IN AUTOMOTIVE APPLICATIONS AT USER'S OWN RISK.**

Resale of ST products with provisions different from the statements and/or technical features set forth in this document shall immediately void any warranty granted by ST for the ST product or service described herein and shall not create or extend in any manner whatsoever, any liability of ST.

ST and the ST logo are trademarks or registered trademarks of ST in various countries.

Information in this document supersedes and replaces all information previously supplied.

The ST logo is a registered trademark of STMicroelectronics. All other names are the property of their respective owners.

© 2009 STMicroelectronics - All rights reserved

STMicroelectronics group of companies

Australia - Belgium - Brazil - Canada - China - Czech Republic - Finland - France - Germany - Hong Kong - India - Israel - Italy - Japan - Malaysia - Malta - Morocco - Philippines - Singapore - Spain - Sweden - Switzerland - United Kingdom - United States of America

[www.st.com](http://www.st.com)

Компания «Океан Электроники» предлагает заключение долгосрочных отношений при поставках импортных электронных компонентов на взаимовыгодных условиях!

Наши преимущества:

- Поставка оригинальных импортных электронных компонентов напрямую с производств Америки, Европы и Азии, а так же с крупнейших складов мира;
- Широкая линейка поставок активных и пассивных импортных электронных компонентов (более 30 млн. наименований);
- Поставка сложных, дефицитных, либо снятых с производства позиций;
- Оперативные сроки поставки под заказ (от 5 рабочих дней);
- Экспресс доставка в любую точку России;
- Помощь Конструкторского Отдела и консультации квалифицированных инженеров;
- Техническая поддержка проекта, помощь в подборе аналогов, поставка прототипов;
- Поставка электронных компонентов под контролем ВП;
- Система менеджмента качества сертифицирована по Международному стандарту ISO 9001;
- При необходимости вся продукция военного и аэрокосмического назначения проходит испытания и сертификацию в лаборатории (по согласованию с заказчиком);
- Поставка специализированных компонентов военного и аэрокосмического уровня качества (Xilinx, Altera, Analog Devices, Intersil, Interpoint, Microsemi, Actel, Aeroflex, Peregrine, VPT, Syfer, Eurofarad, Texas Instruments, MS Kennedy, Miteq, Cobham, E2V, MA-COM, Hittite, Mini-Circuits, General Dynamics и др.);

Компания «Океан Электроники» является официальным дистрибьютором и эксклюзивным представителем в России одного из крупнейших производителей разъемов военного и аэрокосмического назначения «JONHON», а так же официальным дистрибьютором и эксклюзивным представителем в России производителя высокотехнологичных и надежных решений для передачи СВЧ сигналов «FORSTAR».



## JONHON

«JONHON» (основан в 1970 г.)

Разъемы специального, военного и аэрокосмического назначения:

(Применяются в военной, авиационной, аэрокосмической, морской, железнодорожной, горно- и нефтедобывающей отраслях промышленности)

«FORSTAR» (основан в 1998 г.)

ВЧ соединители, коаксиальные кабели,  
кабельные сборки и микроволновые компоненты:

(Применяются в телекоммуникациях гражданского и специального назначения, в средствах связи, РЛС, а так же военной, авиационной и аэрокосмической отраслях промышленности).



Телефон: 8 (812) 309-75-97 (многоканальный)

Факс: 8 (812) 320-03-32

Электронная почта: [ocean@oceanchips.ru](mailto:ocean@oceanchips.ru)

Web: <http://oceanchips.ru/>

Адрес: 198099, г. Санкт-Петербург, ул. Калинина, д. 2, корп. 4, лит. А