

# OMRON

## Smart Sensors High-Precision Contact Type

### ZX-T Series

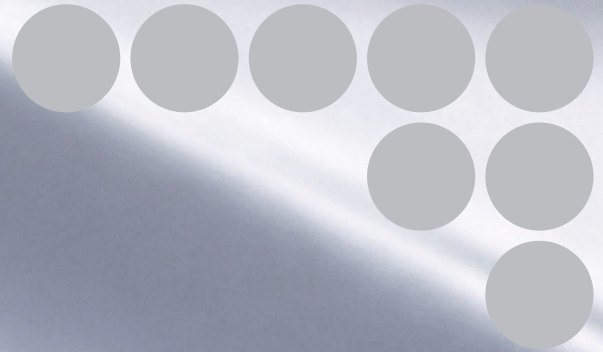

Lineup Includes Vacuum-retracting Models with Ultra-low Operating Force for Long-range Sensing Up to 10 mm.

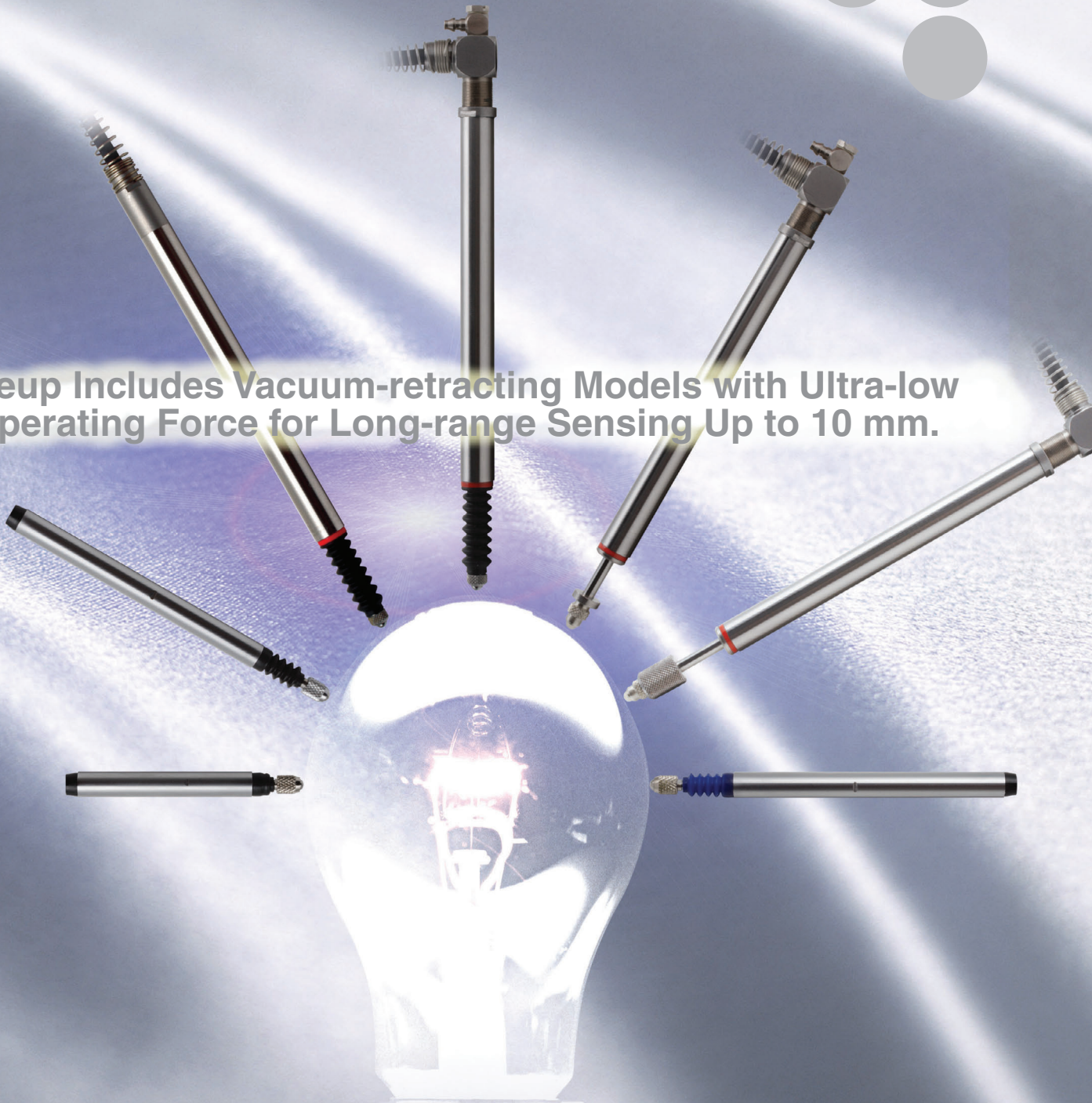

realizing

# Powerful Support for Multi-point and

## Variations

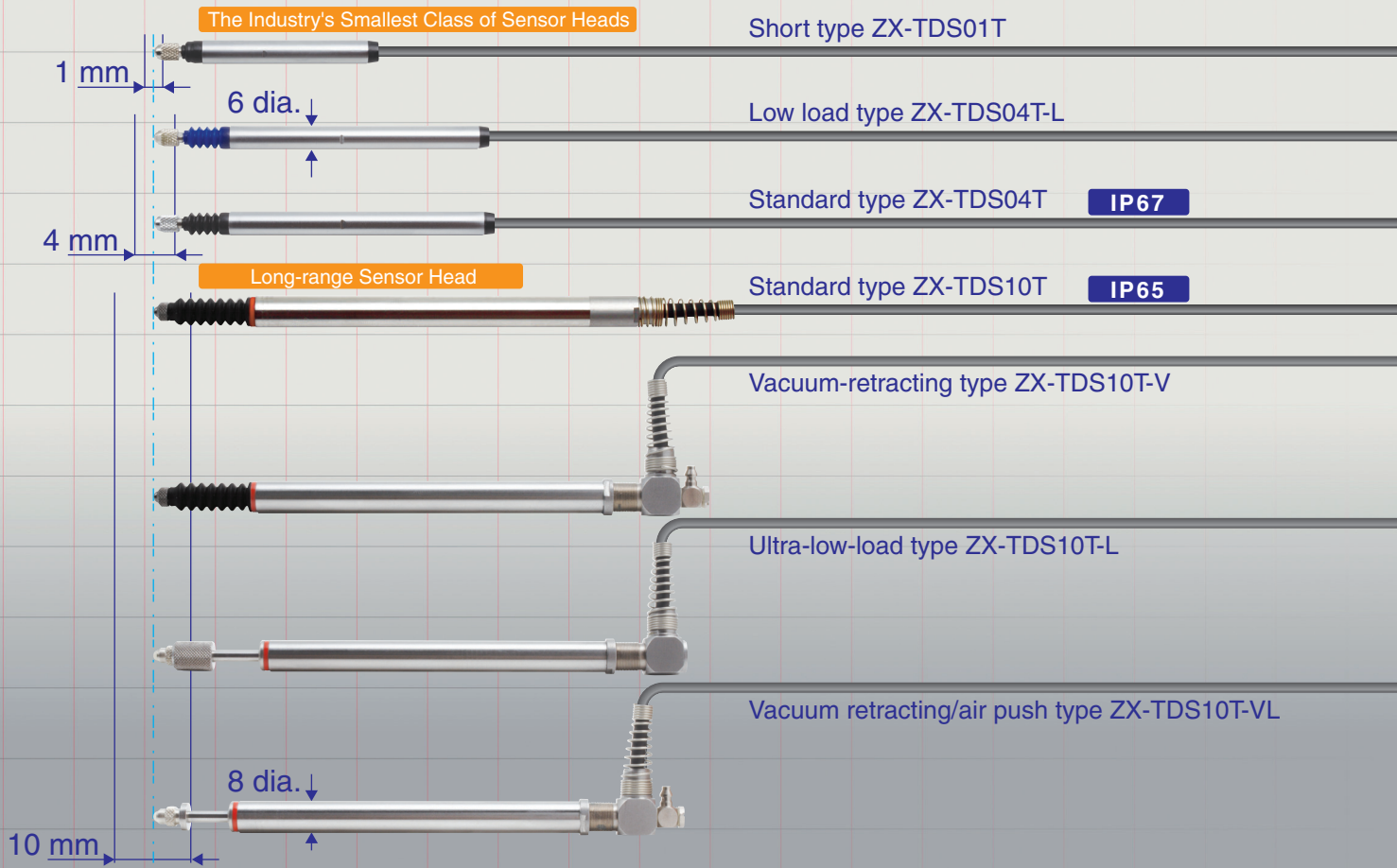

## Smart Sensors

High-Precision Contact Type

### ZX-T Series

The ZX-T Series offers a host of remarkable functions inside a compact body. The complete lineup of Sensor Heads provides various sensing capabilities to handle an even wider range of applications. This is the platform for OMRON's sensing technology.



# Inline Measurement

## Fully Compatible Sensor Heads and Amplifier Units

When changing measurement distances or replacing a damaged Sensor Head, you can continue using the same Amplifier Unit.

ZX-TDA11



## Multi-point Calculation

The multi-point calculation method allows up to 8 Sensor Heads to be connected at one time. Multiple-point addition and subtraction computed based on one Sensor Head yields up to 7 outputs. Analog outputs do not have to be written to a PLC or A/D Board to perform calculations.

All measurement data can be input to a PLC quickly and easily through the Communication Interface Unit.

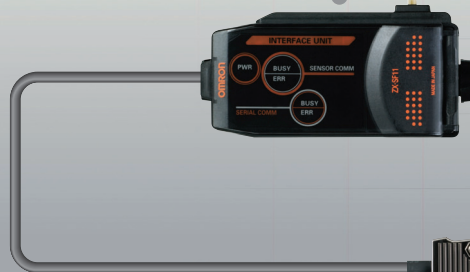

**Note:** A ZX-CAL2 Calculating Unit is required for calculations. An optional ZX-SFW11 or ZX-SF11 Communication Interface Unit is also required for PC/PLC connection.



# The Smart Answer to High-precision Measuring Applications that Were Difficult with Non-contact Types

## Industry's Top Class Resolution

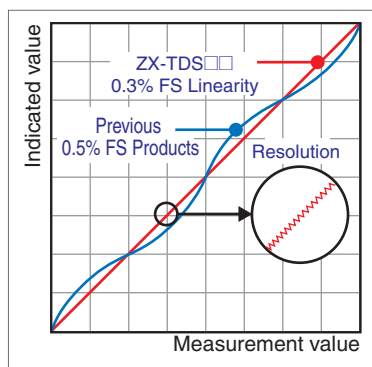

The long-stroke ZX-TDS04T (4-mm measurement range) achieves high-precision measurement with the industry's top class of resolution (0.1 μm) and linearity of 0.3 FS max.

- ZX-TDS10T-□□ long-range type  
Resolution: 0.4 mm, Linearity: ±0.5% FS

## Ultra-low-load Type (0.065 N)

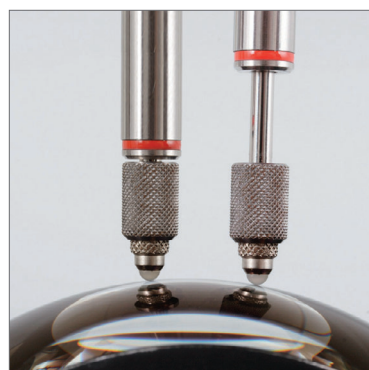

Since micropressure contact is achieved using the Actuator's own weight, these Sensor Heads are ideal for taking measurements where non-contact Sensors cannot be used, such as on transparent and glossy products or products that are easily scratched or warped

## Automate Measurements with Vacuum-retracting Type (Air Lifter Type).

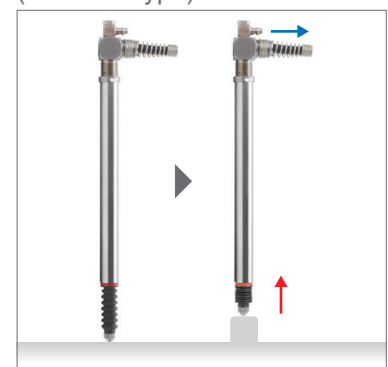

Switching from dial gauges to automatic inspection is a snap with the ZX-TDS10T-V. Meanwhile, the ZX-TDS10T-VL can control air push models in addition to air lift models so that contact force can now be controlled externally.

# Smart Sensors

High-Precision Contact Type

## ZX-T Series

# Combines Reliability and Innovations in Advanced Technology with Remarkable Ease of Use

### No Need to Calculate or Reset the Origin

The ZX-T uses a differential transformer method, so there is no need to change the absolute origin position. As a result, master adjustment and origin calculation do not have to be performed each time operation is started. There is also no need for complex zero point return operations have been eliminated.

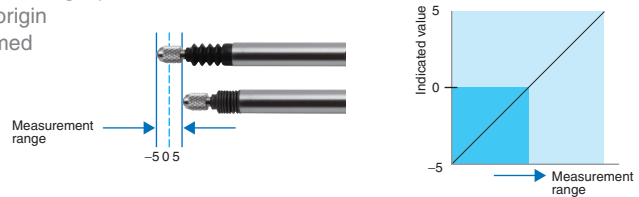

### Auto Scale Function

The Amplifier automatically displays the measurement distance when it is connected to the Sensor Head. The cable also be extended up to 10 meters with no effect on characteristics.

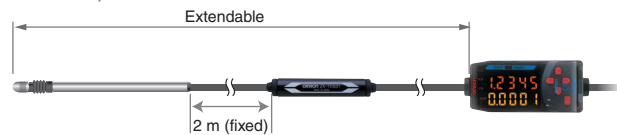

### Warming-up Display

After the power is turned ON, this display indicates when the Sensor Head has warmed up to its optimum measurement condition.



### Long Product Life (Mechanical Durability: 10,000,000 Operations Min.)

The ZX-TDS01T Sensor Head (1-mm measurement range) and the ZX-TDS04T Sensor Head (4-mm measurement range) have long service lives thanks to the unique linear ball-bearing structure shown below. Sliding parts move smoothly and the rubber sleeves keep dust out.

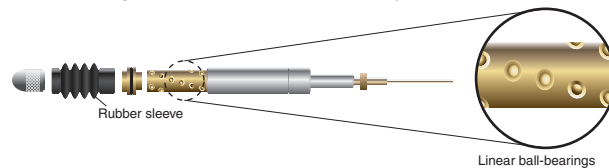

### Pressing Force Alarm

Problems caused by excessive pressing force in inappropriate measurement situations can be detected in advance and a signal can be output to prevent malfunction. For example, preventive measures can be taken with a PLC, such as automatically stopping the measurement.

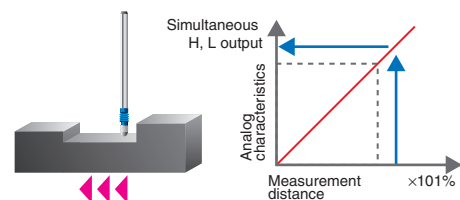

### Actuators (1-mm and 4-mm measurement range types only: ZX-TDS01T and ZX-TDS04T)

Select the most appropriate Actuator for your application.



# A Host of Applications



## Measuring Parts Height during Clock Assembly

The Sensor Head can be placed in direct contact with the measurement object, so height differences can be confirmed even in extremely small parts.

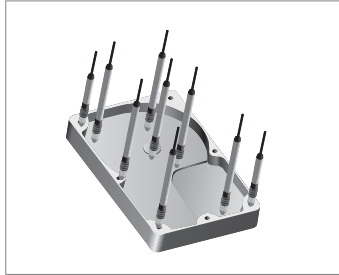

## Measuring Warp in HDD Chassis

Measurement time can be greatly reduced by using the multi-point measurement function.



## Measuring Processing Dimensions in Engine Parts

Because the ZX-TDS01T and ZX-TDS04T conform to IP67, they can be reliably used in applications that are subject to water splashing.

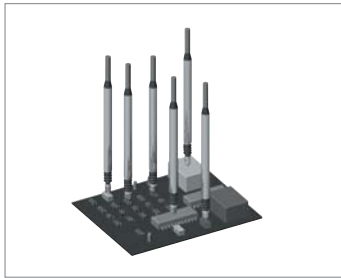

## Insulated Sensor Measurement

The relatively low measurement power allows multi-points to be simultaneously measured for small or thin parts. Because the Sensor Heads are insulated, there is no risk of the measurement object being electrically damaged by leak current. (ZX-TDS01T/04T only)



## Glass Warping Measurement

Sensor Heads with a low measurement force ensure that high-precision measurements can be taken without damaging products.

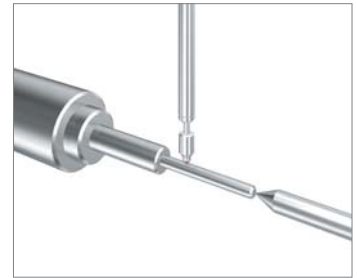

## Precise Product Measurement

Vacuum-retracting Sensor Heads enable post-processing measurements to be automated.



## Small Parts Measurement

Multi-contact Sensor Heads can be used to precisely measure all the dimensions of small parts at the same time.

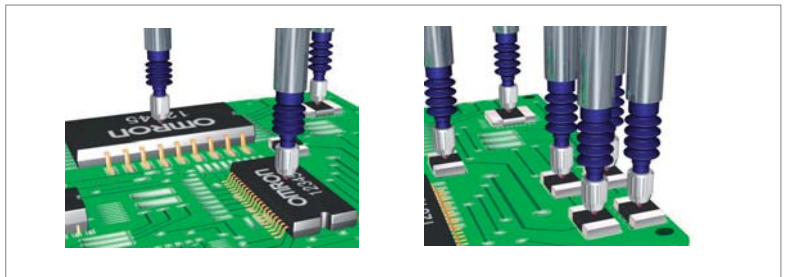

## Electronic Component Measurement

Multiple thin, lightweight Sensor Heads can be arranged to measure the heights of several densely mounted components in different locations all at one time.



# Ordering Information

## Sensors

### Sensor Heads

Size	Type	Sensing distance	Resolution (See note.)	Model	Screw section
6 dia.	Short type	1 mm	0.1 μm	ZX-TDS01T	Male thread
	Standard type	4 mm		ZX-TDS04T	
	Low-load type			ZX-TDS04T-L	
8 dia.	Standard type	10 mm	0.4 μm	ZX-TDS10T	Female thread
	Ultra-low-load Type			ZX-TDS10T-L	
	Air Lift Type			ZX-TDS10T-V	
	Air Lift/Air Push Type			ZX-TDS10T-VL	

**Note:** Refer to the resolution specified in Ratings and Specifications for the conditions required to achieve this resolution.

### Amplifier Units



Appearance	Power supply	Output type	Model
	DC	NPN	ZX-TDA11
		PNP	ZX-TDA41

### Accessories (Order Separately)

#### Calculating Unit

Appearance	Model
	ZX-CAL2

#### Pre-amplifier Mounting Brackets

Appearance	Model	Remarks
	ZX-XBT1	Attached to each Sensor Head
	ZX-XBT2	For DIN Rail mounting

#### ZX-series Communication Interface Unit

Appearance	Name	Model
	ZX-series Communication Interface Unit	ZX-SF11

#### Cables with Connectors on Both Ends (for Extension)

Cable length	Model	Qty
1 m	ZX-XC1A	1
4 m	ZX-XC4A	
8 m	ZX-XC8A	

# Ratings and Specifications

## Sensor Heads (Thin and Lightweight Type)

Item	Model	ZX-TDS01T	ZX-TDS04T	ZX-TDS04T-L
Measurement range		1 mm	4 mm	
Maximum actuator travel distance		Approx. 1.5 mm	Approx. 5 mm	
Resolution (See note 1.)		0.1 μm		
Linearity (See note 2.)		±0.5% FS		
Operating force (See note 3.)		Approx. 0.7 N		Approx. 0.25 N
Degree of protection (Sensor Head)		IP67 (IEC 60529)		IP54
Mechanical durability		10,000,000 operations min.		
Ambient temperature		Operating: 0 to 50°C (with no icing or condensation), Storage: -15 to 60°C (with no icing or condensation)		
Ambient humidity		Operating and storage: 35% to 85% (with no icing or condensation)		
Temperature characteristic (See note 4.)	Sensor Head	0.03% FS/°C	0.01% FS/°C	
	Pre-amplifier	0.01% FS/°C		
Weight (packed state)		Approx. 100 g		
Materials	Sensor Head	Stainless steel		
	Pre-amplifier	Polycarbonate		
	Actuator contact section (See note 5.)	Steel		
Accessories		Instruction manual, Pre-amplifier Mounting Brackets (ZX-XBT1)		

- Note: 1. The resolution is given as the minimum value that can be read when a ZX-TDA11/41 Amplifier Unit is connected. This value is taken 15 minutes after turning ON the power with the average number of operations set to 256.  
 2. The linearity is given as the error in an ideal straight line displacement output.  
 3. These figures are representative values that apply for the measurement center when the provided actuator is used, with the actuator fixed to face downwards. If the actuator is fixed to face horizontally or upwards, the operating force will be reduced. Also, if an actuator other than the standard one is used, the operating force will vary with the weight of the actuator itself.  
 4. These figures are representative values that apply for the mid-point of the measurement range.  
 5. For a Standard Actuator

# Ratings and Specifications

## Sensor Heads (Long-range Type)

Model	ZX-TDS10T	ZX-TDS10T-V	ZX-TDS10T-L	ZX-TDS10T-VL
Vacuum retract (VR) and air push (AP) compatible	No	VR	No	VR/AP
Measurement range	10 mm			
Maximum actuator travel distance	10.5 mm			
Resolution (See notes 1 and 5.)	0.4 $\mu$ m			
Linearity (See notes 2 and 5.)	$\pm$ 0.5% FS			
Operating force (See note 3.)	Approx. 0.7 N	Approx. 0.6 N	Approx. 0.065 N	0.09 to 1.41N
Air pressure	Vacuum retracting	-0.55 to -0.70 (bar)	---	-0.22 to -0.5 (bar)
	Air push	---	---	0.125 to 2 (bar)
Degree of protection	Sensor Head	IP65	IP50	IP50
	Preamplifier	IP40		
Mechanical durability	10,000,000 operations min.			
Ambient temperature	Operating: 0 to 50°C (with no icing or condensation), Storage: -10 to 60°C (with no icing or condensation)			
Ambient humidity	Operating and storage: 35% to 85% (with no icing or condensation)			
Temperature characteristic (See note 4.)	Sensor Head	$\pm$ 0.01% FS/°C		
	Preamplifier	$\pm$ 0.01% FS/°C		
Vibration resistance	0.35-mm single amplitude at 10 to 55 Hz for 50 min each in the X, Y, and Z directions			
Shock resistance	150 m/S <sup>2</sup> 3 times each in 6 directions (up/down, left/right, and forward/backward)			
Connection method	Prewired connector (2 m from the Sensor Head to the Preamplifier, 0.2 m from the Preamplifier to the connector)			
Weight (packed state)	Approx. 100 g			
Materials	Sensor Head	Stainless steel		
	Rubber sleeve	Viton		None
	Preamplifier	Polycarbonate		
	Mounting Brackets	Stainless steel		Polyamide
Actuator contact section (See note 7.)	Super steel			
Accessories	Instruction manual, Preamplifier Mounting Brackets (ZX-XBT1), Right-angle Adapter (See note 6.)			

- Note: 1. The resolution indicates the variation ( $\pm 3\sigma$ ) in the linear output (voltage output) when a ZX-TDA11/41 Amplifier Unit is connected. This value is taken 30 minutes after turning ON the power with the average number of operations set to 1,024. The minimum value that can be read is 1  $\mu$ m.
2. The linearity is given as the error in an ideal straight line displacement output.
3. These figures are representative values that apply for the mid-point of the measurement range when the Actuator provided is secured facing downward.
- ZX-TDS10T and ZX-TDS10T-V ZX-TDS10T-VL: The operating force will be reduced if the Actuator is secured facing horizontally or upward.
  - ZX-TDS10T-L: The actuator can be installed only facing downward.
4. These figures are representative values that apply for the mid-point of the measurement range.
5. These values were measured at an ambient temperature of 23°C.
6. The ZX-TDS10□ comes with a Right-angle Adapter.
7. For a Standard Actuator

## Amplifier Units

Item	Model	ZX-TDA11	ZX-TDA41
Measurement period (See note 1.)		1 ms	
Possible average count settings		1, 16, 32, 64, 128, 256, 512, or 1,024	
Linear output (See note 2.)		4 to 20 mA/FS, Max. load resistance: 300 $\Omega$ $\pm$ 4 V ( $\pm$ 5 V, 1 to 5 V (See note 3.)), Output impedance: 100 $\Omega$	
Judgement outputs (3 outputs: HIGH/PASS/LOW)		NPN open-collector outputs, 30 VDC, 30 mA max. Residual voltage: 1.2 V max.	PNP open-collector outputs, 30 VDC, 30 mA max. Residual voltage: 2 V max.
Zero reset input, timing input, reset input, judgement output hold input		ON: Short-circuited with 0-V terminal or 1.5 V OFF: Open (leakage current: 0.1 mA max.)	
Function		<ul style="list-style-type: none"> <li>- Measurement value display - Present value/set value/output value display</li> <li>- Display reverse - ECO mode - Number of display digit changes</li> <li>- Sample hold - Peak hold - Bottom hold - Peak-to-peak hold</li> <li>- Self-peak hold - Self-bottom hold - Zero reset</li> <li>- Initial reset - Direct threshold value setting - Position teaching</li> <li>- Hysteresis width setting - Timing inputs - Reset input</li> <li>- Judgement output hold input - Monitor focus - (A-B) calculations (See note 4.)</li> <li>- (A+B) calculations (See note 4.) - Sensor disconnection detection - Zero reset memory</li> <li>- Function lock - Non-measurement setting - Clamp value setting</li> <li>- Scale inversion - Zero reset indicator - Span adjustment</li> <li>- Warming-up display - Pressing force alarm</li> </ul>	
Indicators		Operation indicators: High (orange), pass (green), low (yellow), 7-segment main digital display (red), 7-segment sub-digital display (yellow), power ON (green), zero reset (green), enable (green)	
Power supply voltage		12 to 24 VDC $\pm$ 10%, Ripple (p-p): 10% max.	
Current consumption		140 mA max. (with Sensor connected)	
Ambient temperature		Operating and storage: 0 to 50°C (with no icing or condensation)	
Temperature characteristic		0.03% FS/°C	
Connection method		Prewired (standard cable length: 2 m)	
Weight (packed state)		Approx. 350 g	
Materials		Case: PBT (polybutylene terephthalate), Cover: Polycarbonate	

- Note: 1. The response time for the first linear output or judgment output is calculated as follows (with fixed sensitivity): Measurement period  $\times$  (Average count setting + 1).  
The response time for the second and later outputs is the measurement period specified in the table.
2. The output can be switched between a current output and voltage output using a switch on the base of the Amplifier Unit.
3. Setting is possible via the monitor focus function.
4. A Calculating Unit (ZX-CAL2) is required.

Sensors

ZX-TDS01T

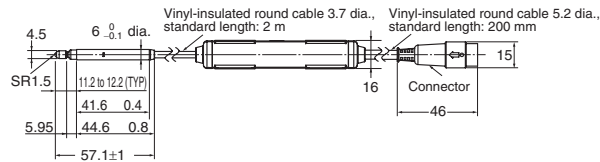

ZX-TDS04T/04T-L

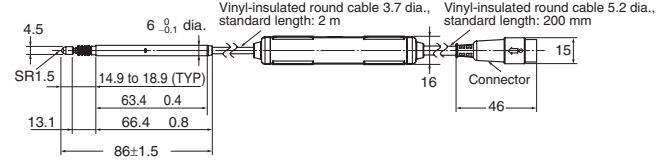

ZX-TDS10T

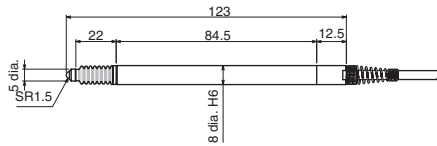

ZX-TDS10T-L

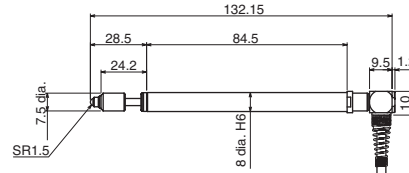

ZX-TDS10T-V

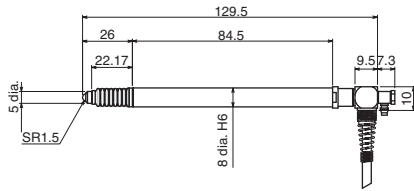

ZX-TDS10T-VL

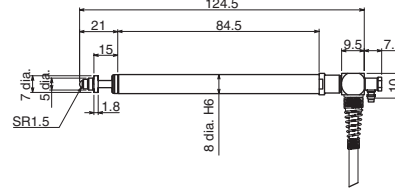

Amplifier Unit

ZX-TDA11  
 ZX-TDA41

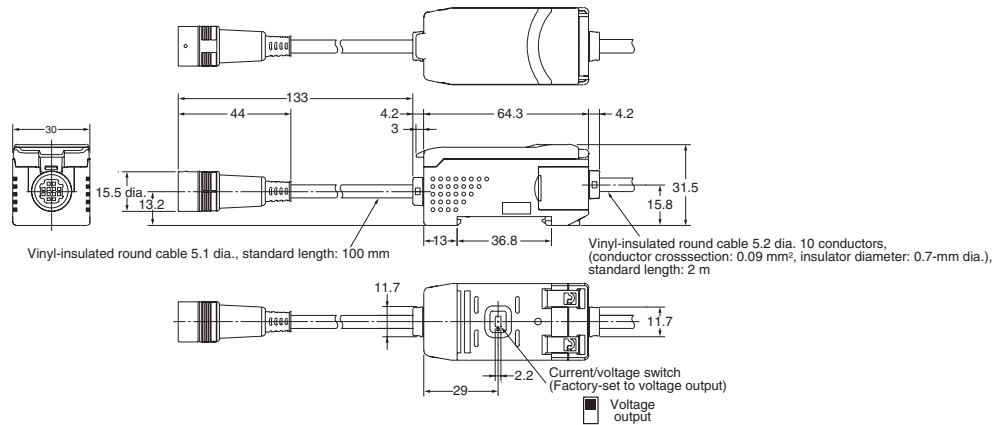

This document provides information mainly for selecting suitable models. Please read the *Operation Manual* (E346) carefully for information that the user must understand and accept before purchase, including information on warranty, limitations of liability, and precautions.

**OMRON Corporation**  
 Industrial Automation Company  
 Sensing Devices Division H.Q.  
 Application Sensors Division  
 Shiokoji Horikawa, Shimogyo-ku,  
 Kyoto, 600-8530 Japan  
 Tel: (81) 75-344-7068/Fax: (81) 75-344-7107

**Regional Headquarters**  
**OMRON EUROPE B.V.**  
 Sensor Business Unit  
 Carl-Benz-Str. 4, D-71154 Nufringen,  
 Germany  
 Tel: (49) 7032-811-0/Fax: (49) 7032-811-199

**OMRON ELECTRONICS LLC**  
 One Commerce Drive Schaumburg,  
 IL 60173-5302 U.S.A.  
 Tel: (1) 847-843-7900/Fax: (1) 847-843-7787

**OMRON ASIA PACIFIC PTE. LTD.**  
 No. 438A Alexandra Road # 05-05/08 (Lobby 2),  
 Alexandra Technopark, Singapore 119967  
 Tel: (65) 6835-3011/Fax: (65) 6835-2711

**OMRON (CHINA) CO., LTD.**  
 Room 2211, Bank of China Tower,  
 200 Yin Cheng Zhong Road,  
 PuDong New Area, Shanghai, 200120, China  
 Tel: (86) 21-5037-2222/Fax: (86) 21-5037-2200

**Authorized Distributor:**

In the interest of product improvement, specifications are subject to change without notice.



Компания «Океан Электроники» предлагает заключение долгосрочных отношений при поставках импортных электронных компонентов на взаимовыгодных условиях!

Наши преимущества:

- Поставка оригинальных импортных электронных компонентов напрямую с производств Америки, Европы и Азии, а так же с крупнейших складов мира;
- Широкая линейка поставок активных и пассивных импортных электронных компонентов (более 30 млн. наименований);
- Поставка сложных, дефицитных, либо снятых с производства позиций;
- Оперативные сроки поставки под заказ (от 5 рабочих дней);
- Экспресс доставка в любую точку России;
- Помощь Конструкторского Отдела и консультации квалифицированных инженеров;
- Техническая поддержка проекта, помощь в подборе аналогов, поставка прототипов;
- Поставка электронных компонентов под контролем ВП;
- Система менеджмента качества сертифицирована по Международному стандарту ISO 9001;
- При необходимости вся продукция военного и аэрокосмического назначения проходит испытания и сертификацию в лаборатории (по согласованию с заказчиком);
- Поставка специализированных компонентов военного и аэрокосмического уровня качества (Xilinx, Altera, Analog Devices, Intersil, Interpoint, Microsemi, Actel, Aeroflex, Peregrine, VPT, Syfer, Eurofarad, Texas Instruments, MS Kennedy, Miteq, Cobham, E2V, MA-COM, Hittite, Mini-Circuits, General Dynamics и др.);

Компания «Океан Электроники» является официальным дистрибьютором и эксклюзивным представителем в России одного из крупнейших производителей разъемов военного и аэрокосмического назначения «JONHON», а так же официальным дистрибьютором и эксклюзивным представителем в России производителя высокотехнологичных и надежных решений для передачи СВЧ сигналов «FORSTAR».



## JONHON

«JONHON» (основан в 1970 г.)

Разъемы специального, военного и аэрокосмического назначения:

(Применяются в военной, авиационной, аэрокосмической, морской, железнодорожной, горно- и нефтедобывающей отраслях промышленности)

«FORSTAR» (основан в 1998 г.)

ВЧ соединители, коаксиальные кабели, кабельные сборки и микроволновые компоненты:

(Применяются в телекоммуникациях гражданского и специального назначения, в средствах связи, РЛС, а так же военной, авиационной и аэрокосмической отраслях промышленности).



Телефон: 8 (812) 309-75-97 (многоканальный)

Факс: 8 (812) 320-03-32

Электронная почта: [ocean@oceanchips.ru](mailto:ocean@oceanchips.ru)

Web: <http://oceanchips.ru/>

Адрес: 198099, г. Санкт-Петербург, ул. Калинина, д. 2, корп. 4, лит. А