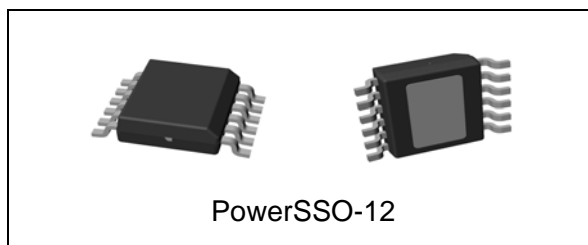


## Automotive 5 V low drop voltage regulator

Datasheet - production data




- Programmable reset pulse delay with external capacitor
- Early warning
- Very wide stability range with low value output capacitor
- Thermal shutdown and short circuit protection
- Wide temperature range ( $T_j = -40\text{ °C}$  to  $150\text{ °C}$ )
- Enable input for enabling / disabling the voltage regulator

### Features

Max DC supply voltage	$V_S$	40 V
Max output voltage tolerance	$\Delta V_0$	+/-2%
Max dropout voltage	$V_{dp}$	500 mV
Output current	$I_0$	300 mA
Quiescent current	$I_{qn}$	5 $\mu\text{A}^{(1)}$ 55 $\mu\text{A}^{(2)}$

1. Typical value with regulator disabled.
2. Typical value with regulator enabled.

- AEC-Q100 qualified 
- Operating DC supply voltage range
- 5.6 V to 40 V
- Low dropout voltage
- 300 mA current capability
- Low quiescent current
- Very low consumption mode
- Precision output voltage 5 V +/- 2%
- Reset circuit sensing the output voltage

### Description

L5300GJ is a low dropout linear regulator with microprocessor control functions such as power on reset, low voltage reset, early warning, ON/OFF control. Typical quiescent current is 55  $\mu\text{A}$  in very low output current mode and enabled regulator. It drops to 5  $\mu\text{A}$  with not enabled regulator.

On-chip trimming results in high output voltage accuracy (2%). Accuracy is kept over wide temperature range, line and load variation. Early warning circuit monitors the input voltage and compares it with an internal voltage reference.

The maximum input voltage is 40 V. The maximum output current is internally limited.

Internal temperature protection disables the voltage regulator output. In addition, only low value ceramic capacitor on output is required for stability (equal or above 220 nF).

Table 1. Device summary

Package	Order codes	
	Tube	Tape and reel
PowerSSO-12	L5300GJ	L5300GJTR

# Contents

- 1      Block diagram and pins description ..... 5**
  
- 2      Electrical specifications ..... 7**
  - 2.1    Absolute maximum ratings ..... 7
  - 2.2    Thermal data ..... 7
  - 2.3    Electrical characteristics ..... 8
  - 2.4    Electrical characteristics curves ..... 10
  
- 3      Application information ..... 14**
  - 3.1    Voltage regulator ..... 14
  - 3.2    Reset ..... 16
  - 3.3    Early warning ..... 16
  - 3.4    Enable ..... 17
  
- 4      Package and PCB thermal data ..... 18**
  
- 5      Package and packing information ..... 21**
  - 5.1    ECOPACK® ..... 21
  - 5.2    PowerSSO-12 mechanical data ..... 21
  - 5.3    PowerSSO-12 packing information ..... 23
  
- 6      Revision history ..... 24**

## List of tables

Table 1.	Device summary . . . . .	1
Table 2.	Pins description . . . . .	6
Table 3.	Absolute maximum ratings . . . . .	7
Table 4.	Thermal data . . . . .	7
Table 5.	General . . . . .	8
Table 6.	Reset . . . . .	9
Table 7.	Early warning . . . . .	9
Table 8.	Enable. . . . .	9
Table 9.	PowerSSO-12 thermal parameter . . . . .	20
Table 10.	PowerSSO-12 mechanical data . . . . .	22
Table 11.	Document revision history . . . . .	24

## List of figures

Figure 1.	Block diagram	5
Figure 2.	Configuration diagram (top view)	5
Figure 3.	Output voltage vs $T_j$	10
Figure 4.	Output voltage vs $V_S$	10
Figure 5.	Output voltage vs $V_{En}$	10
Figure 6.	Drop voltage vs. output current	10
Figure 7.	Current consumption vs. output current	10
Figure 8.	Current consumption vs. output current (at light load condition)	10
Figure 9.	Current consumption vs input voltage ( $I_o = 0.1$ mA)	11
Figure 10.	Current consumption vs input voltage ( $I_o = 100$ mA)	11
Figure 11.	Current limitation vs $T_j$	11
Figure 12.	Current limitation vs input voltage	11
Figure 13.	Short-circuit current vs $T_j$	11
Figure 14.	Short-circuit current vs input voltage	11
Figure 15.	$V_{En\_high}$ vs $T_j$	12
Figure 16.	$V_{En\_low}$ vs $T_j$	12
Figure 17.	$V_{Rth}$ vs $T_j$	12
Figure 18.	$V_{Rlth}$ vs $T_j$	12
Figure 19.	$V_{EWi\_thh}$ vs $T_j$	12
Figure 20.	$V_{EWi\_thl}$ vs $T_j$	12
Figure 21.	$I_{cr}$ vs $T_j$	13
Figure 22.	$I_{dr}$ vs $T_j$	13
Figure 23.	Application schematic	14
Figure 24.	Stability region	15
Figure 25.	Maximum load variation response	15
Figure 26.	Reset time diagram	16
Figure 27.	Early warning time diagram	17
Figure 28.	PowerSSO-12 PC board <sup>(1)</sup>	18
Figure 29.	$R_{thj-amb}$ Vs. PCB copper area in open box free air condition	18
Figure 30.	PowerSSO-12 thermal impedance junction ambient single pulse	19
Figure 31.	Thermal fitting model of $V_{reg}$ in in PowerSSO-12	19
Figure 32.	PowerSSO-12 package dimensions	21
Figure 33.	PowerSSO-12 tube shipment (no suffix)	23
Figure 34.	PowerSSO-12 tape and reel shipment (suffix "TR")	23

# 1 Block diagram and pins description

Figure 1. Block diagram

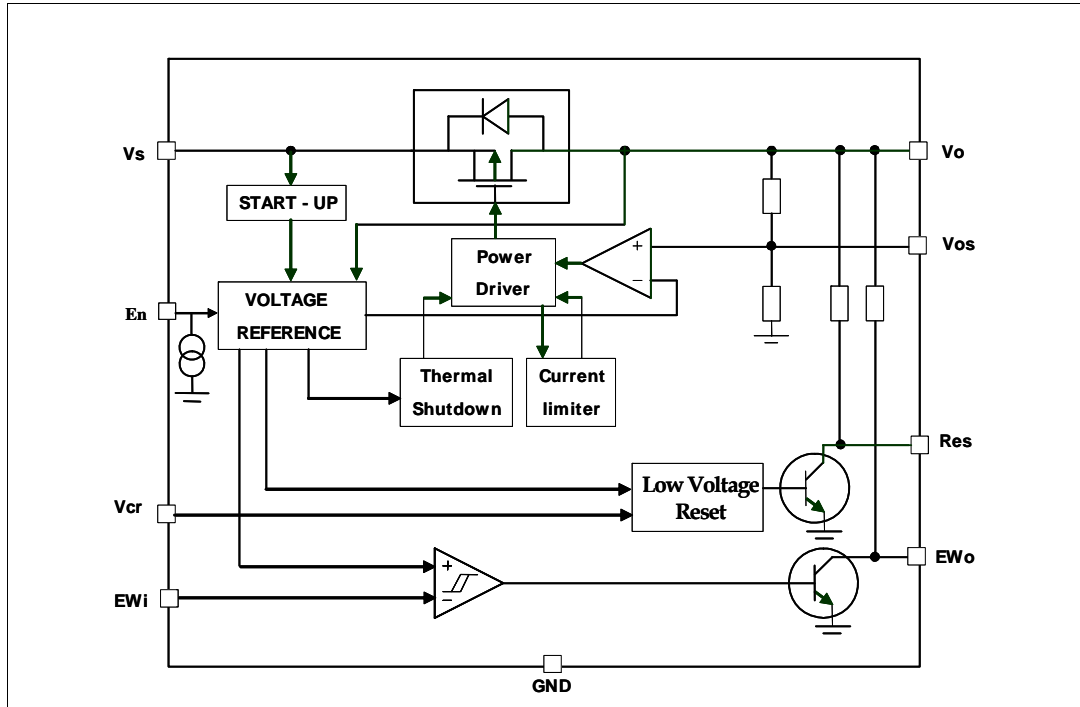


Figure 2. Configuration diagram (top view)

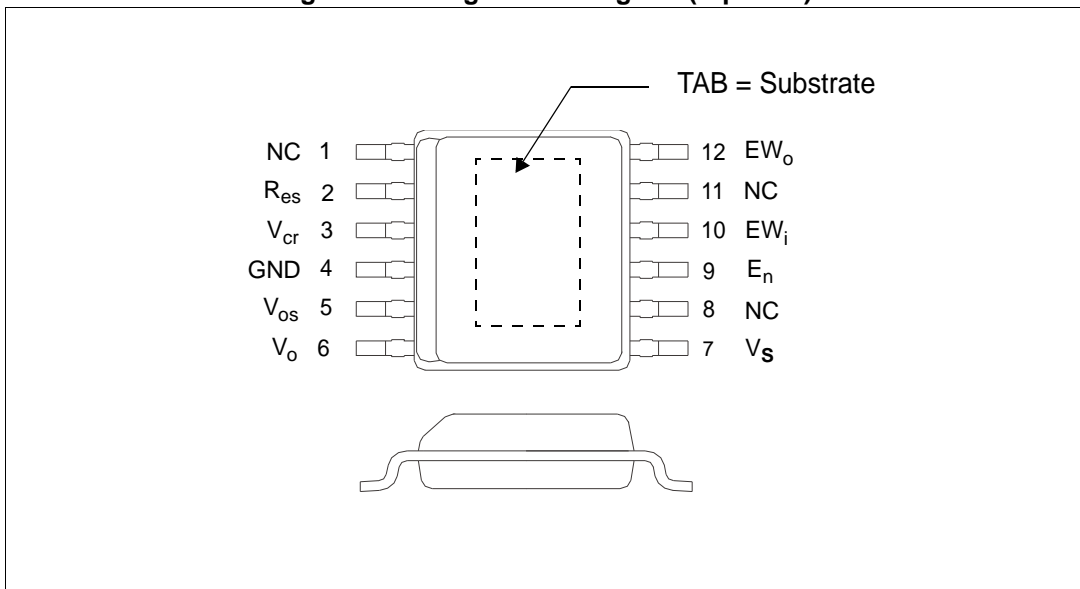


Table 2. Pins description

N°	Name	Function
1	NC	Not connected
2	R <sub>es</sub>	Reset output. Internally connected to V <sub>o</sub> through a 20 KΩ pull up resistor. This pin is pulled low when V <sub>o</sub> < V <sub>o_th</sub> . Keep open if not needed
3	V <sub>cr</sub>	Reset delay. Connect an external capacitor between V <sub>cr</sub> pin and ground to adjust the reset delay time. Keep open if not needed
4	GND	Ground reference
5	V <sub>os</sub>	Regulator output voltage sensing (connect to V <sub>o</sub> )
6	V <sub>o</sub>	5 V regulated output. Block to GND with a ceramic capacitor (C <sub>o</sub> ≥ 220 nF for regulator stability)
7	V <sub>S</sub>	Supply voltage, block directly to GND on the IC with a capacitor
8	NC	Not connected
9	E <sub>n</sub>	Enable input. A high signal switches the regulator ON. Connect to V <sub>S</sub> if not needed
10	EW <sub>i</sub>	Early warning input. This pin monitors the V <sub>S</sub> voltage level through a resistor divider. Connect to V <sub>S</sub> if not needed
11	NC	Not connected
12	EW <sub>o</sub>	Early warning output. Internally connected to V <sub>o</sub> through 20 KΩ pull up resistor. This pin is pulled low when EW <sub>i</sub> is below bandgap reference voltage. Keep open if not needed
-	TAB	TAB is connected to the substrate of the chip: connect to GND or leave open (see <a href="#">Figure 2</a> ).

## 2 Electrical specifications

### 2.1 Absolute maximum ratings

Stressing the device above the rating listed in the [Table 3: Absolute maximum ratings](#) may cause permanent damage to the device. These are stress ratings only and operation of the device at these or any other conditions above those indicated in the operating sections of this specification is not implied. Exposure to absolute maximum rating conditions for extended periods may affect device reliability.

**Table 3. Absolute maximum ratings**

Symbol	Parameter	Value	Unit
$V_{sdc}$	DC supply voltage	-0.3 to 40	V
$I_{Vsdc}$	Input current	Internally limited	
$V_{odc}$	DC output voltage	-0.3 to 6	V
$I_{Vodc}$	DC output current	Internally limited	
$V_{od Res}$	Open drain output voltage $R_{es}$	-0.3 to $V_{odc} + 0.3$	V
$I_{od Res}$	Open drain output current $R_{es}$	Internally limited	
$V_{od EW_o}$	Open drain output voltage $EW_o$	-0.3 to $V_{odc} + 0.3$	V
$I_{od EW_o}$	Open drain output current $EW_o$	Internally limited	
$V_{cr}$	$V_{cr}$ voltage	-0.3 to $V_o + 0.3$	V
$V_{EWi}$	Early warning input voltage	-0.3 to 40	V
$V_{En}$	Enable input	-0.3 to 40	V
$T_j$	Junction temperature	-40 to 150	°C
$V_{ESD HBM}$	ESD HBM voltage level (HBM-MIL STD 883C)	+/- 2	kV
$V_{ESD CDM}$	ESD CDM voltage level (CDM AEC-Q100-011)	+/- 750	V

### 2.2 Thermal data

**Table 4. Thermal data**

Symbol	Parameter	Value	Unit
$R_{thj-case}$	Thermal resistance junction to case: PowerSSO-12	8	°K/W
$R_{thj-amb}$	Thermal resistance junction to ambient: PowerSSO-12	48	°K/W

*Note:* The values quoted are for PCB 77mm x 86 mm x 1.6mm, FR4, double layer with thermal vias (one copper heatsink layer, thickness 0.070 mm, area 8 cm<sup>2</sup>).

## 2.3 Electrical characteristics

Values specified in this section are for  $V_S = 5.6\text{ V to }31\text{ V}$ ,  $T_j = -40^\circ\text{C to }150^\circ\text{C}$  unless otherwise stated.

Table 5. General

Pin	Symbol	Parameter	Test condition	Min.	Typ.	Max.	Unit
$V_o$	$V_{o\_ref}$	Output voltage	$V_S = 8\text{ V to }18\text{ V}$ ; $I_o = 8\text{ mA to }300\text{ mA}$	4.9	5.0	5.1	V
$V_o$	$V_{o\_ref}$	Output voltage	$V_S = 5.6\text{ V to }31\text{ V}$ ; $I_o = 8\text{ mA to }300\text{ mA}$	4.85	5.0	5.15	V
$V_o$	$V_{o\_ref}$	Output voltage	$V_S = 5.6\text{ V to }31\text{ V}$ ; $I_o = 0.1\text{ mA to }8\text{ mA}$	4.75	5.0	5.25	V
$V_o$	$I_{short}$	Short circuit current	$V_S = 13.5\text{ V}$	0.8	1.8	2.6	A
$V_o$	$I_{lim}$	Output current capability <sup>(1)</sup>	$V_S = 13.5\text{ V}$	0.6	1.6	2.5	A
$V_S, V_o$	$V_{line}$	Line regulation voltage	$V_S = 6\text{ V to }28\text{ V}$ ; $I_o = 60\text{ mA}$			40	mV
$V_o$	$V_{load}$	Load regulation voltage	$V_S = 13.5\text{ V}$ ; $I_o = 8\text{ mA to }300\text{ mA}$ ; $T_j = 25^\circ\text{C}$			40	mV
			$V_S = 8\text{ V to }18\text{ V}$ ; $I_o = 8\text{ mA to }300\text{ mA}$			55	
$V_S, V_o$	$V_{dp}$	Drop voltage <sup>(2)</sup>	$I_o = 300\text{ mA}$			500	mV
$V_S, V_o$	SVR	Ripple rejection	$f_r = 100\text{ Hz}$ <sup>(3)</sup>		60		dB
$V_o$	$I_{oth\_H}$	Normal consumption mode output current		8			mA
$V_o$	$I_{oth\_L}$	Very low consumption mode output current				1.1	mA
$V_o$	$I_{oth\_Hyst}$	Output current switching threshold hysteresis	$V_S = 13.5\text{ V}$ ; $T_j = 25^\circ\text{C}$		0.8		mA
$V_S, V_o$	$I_{qs}$	Current consumption with regulator disabled $I_{qs} = I_{V_S} - I_o$	$V_S = 13.5\text{ V}$ ; $E_n = \text{low}$		5	10	$\mu\text{A}$
$V_S, V_o$	$I_{qn\_1}$	Current consumption with regulator enabled $I_{qn\_1} = I_{V_S} - I_o$	$V_S = 13.5\text{ V}$ ; $I_o = 0.1\text{ mA to }1\text{ mA}$ ; $E_n = \text{high}$		55	80	$\mu\text{A}$
$V_S, V_o$	$I_{qn\_300}$	Current consumption with regulator enabled $I_{qn\_300} = I_{V_S} - I_o$	$V_S = 13.5\text{ V}$ ; $I_o = 300\text{ mA}$ ; $E_n = \text{high}$		3	4.2	mA
	$T_w$	Thermal protection temperature		150		190	$^\circ\text{C}$
	$T_{w\_hy}$	Thermal protection temperature hysteresis			10		$^\circ\text{C}$

1. Measured output current when the output voltage has dropped 100 mV from its nominal value obtained at 13.5 V and  $I_o = 75\text{ mA}$ .



2.  $V_S - V_O$  measured dropout when the output voltage has dropped 100 mV from its nominal value obtained at 13.5V and  $I_O = 75$  mA.
3. Guaranteed by design.

Table 6. Reset

Pin	Symbol	Parameter	Test condition	Min.	Typ.	Max.	Unit
R <sub>es</sub>	V <sub>Res_l</sub>	Reset output low voltage	R <sub>ext</sub> = 5 kΩ; V <sub>o</sub> > 1 V			0.4	V
R <sub>es</sub>	I <sub>Res_lkg</sub>	Reset output high leakage current	V <sub>Res</sub> = V <sub>out</sub>			1	μA
R <sub>es</sub>	R <sub>res</sub>	Pull-up internal resistance	Versus V <sub>o</sub>	10	20	40	kΩ
R <sub>es</sub>	V <sub>o_th</sub>	V <sub>o</sub> out of regulation threshold	V <sub>o</sub> decreasing	6	8	10	%below V <sub>o_ref</sub>
V <sub>cr</sub>	V <sub>Rlth</sub>	Reset timing low threshold	V <sub>S</sub> = 13.5 V	15	18	22	% V <sub>o_ref</sub>
V <sub>cr</sub>	V <sub>Rhth</sub>	Reset timing high threshold	V <sub>S</sub> = 13.5 V	47	50	53	% V <sub>o_ref</sub>
V <sub>cr</sub>	I <sub>cr</sub>	Charge current	V <sub>S</sub> = 13.5 V	10	20	30	μA
V <sub>cr</sub>	I <sub>dr</sub>	Discharge current	V <sub>S</sub> = 13.5 V	10	20	30	μA
R <sub>es</sub>	T <sub>rr</sub>	Reset reaction time				2	μs
R <sub>es</sub>	T <sub>rd</sub>	Reset delay time	V <sub>S</sub> = 13.5 V; C <sub>tr</sub> = 1 nF	2	4	6	ms

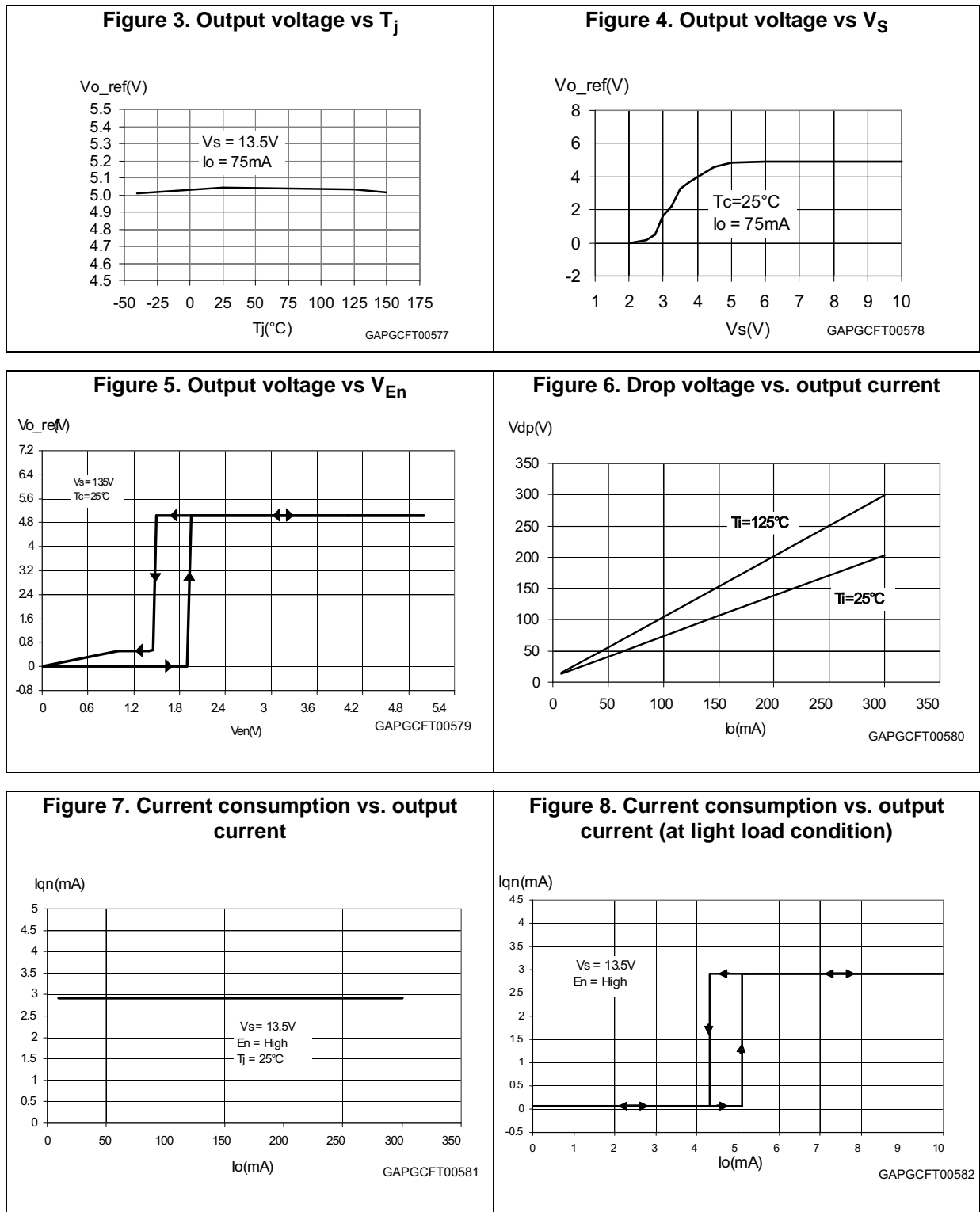
Table 7. Early warning

Pin	Symbol	Parameter	Test condition	Min.	Typ.	Max.	Unit
EW <sub>i</sub>	E <sub>wi_th_low</sub>	EW input low threshold voltage		2.35	2.50	2.65	V
EW <sub>i</sub>	E <sub>wi_th_high</sub>	EW input high threshold voltage		2.42	2.57	2.72	V
EW <sub>i</sub>	E <sub>wi_th_hyst</sub>	EW input threshold hysteresis			70		mV
EW <sub>i</sub>	I <sub>EWi_lkg</sub>	EW input leakage current	V <sub>EWi</sub> = 0 V; V <sub>S</sub> > 3 V	-1		1	μA
EW <sub>o</sub>	R <sub>EWo</sub>	Pull-up internal resistance	Versus V <sub>o</sub>	10	20	40	kΩ
EW <sub>o</sub>	E <sub>Wo_lv</sub>	EW output low voltage (with external pull up)	V <sub>EWi</sub> < 2.35 V; V <sub>S</sub> > 4 V; R <sub>ext</sub> = 5 kΩ			400	mV
EW <sub>o</sub>	I <sub>Wo</sub>	EW output leakage	V <sub>EWo</sub> = 5 V			1	μA

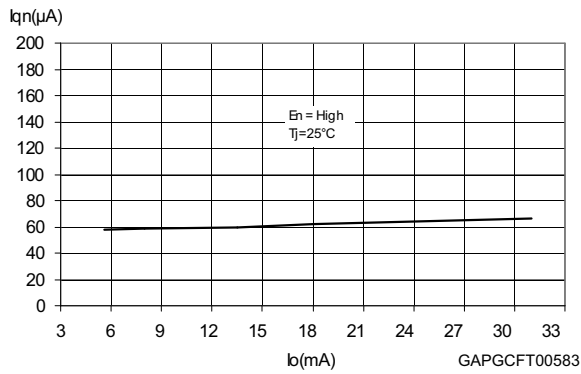
Table 8. Enable

Pin	Symbol	Parameter	Test condition	Min.	Typ.	Max.	Unit
E <sub>n</sub>	V <sub>En_low</sub>	E <sub>n</sub> input low voltage				1	V
E <sub>n</sub>	V <sub>En_high</sub>	E <sub>n</sub> input high voltage		3			V
E <sub>n</sub>	V <sub>En_hyst</sub>	E <sub>n</sub> input hysteresis			500		mV
E <sub>n</sub>	I <sub>leak</sub>	Pull-down current	V <sub>En</sub> = 5 V		3	10	μA

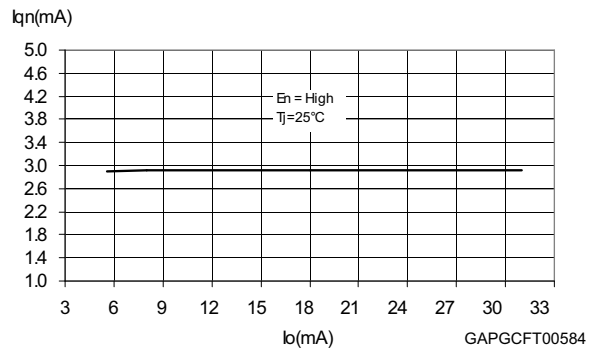
## 2.4 Electrical characteristics curves



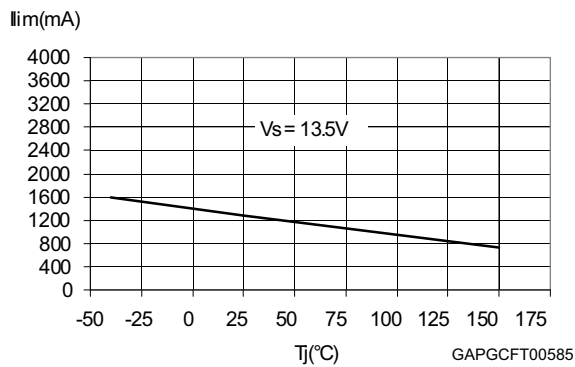
**Figure 9. Current consumption vs input voltage ( $I_o = 0.1 \text{ mA}$ )**



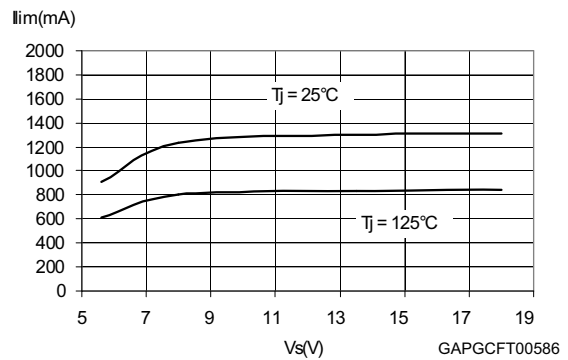
**Figure 10. Current consumption vs input voltage ( $I_o = 100 \text{ mA}$ )**



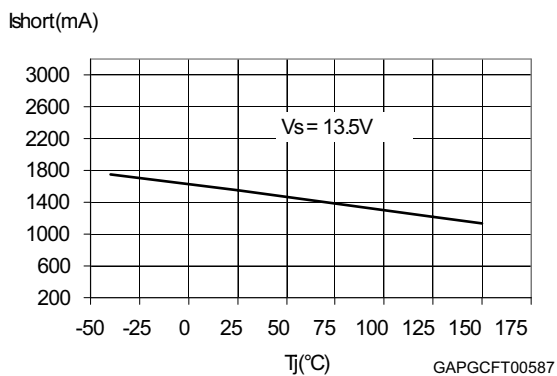
**Figure 11. Current limitation vs  $T_j$**



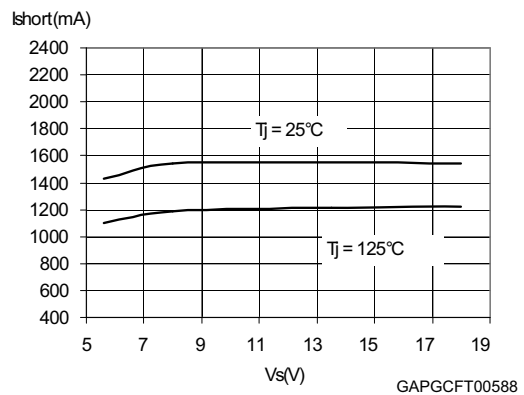
**Figure 12. Current limitation vs input voltage**

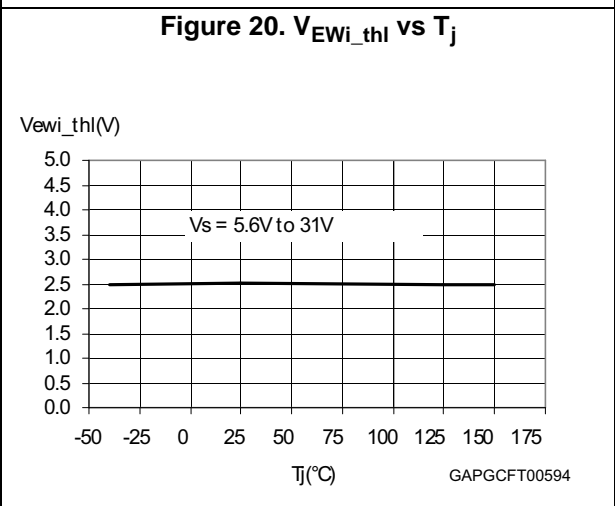
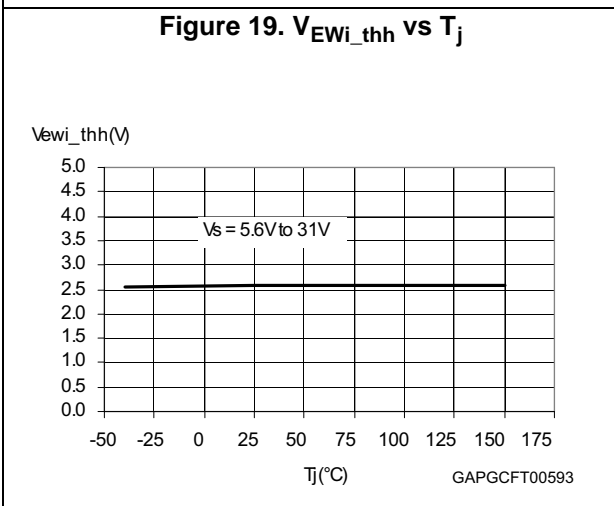
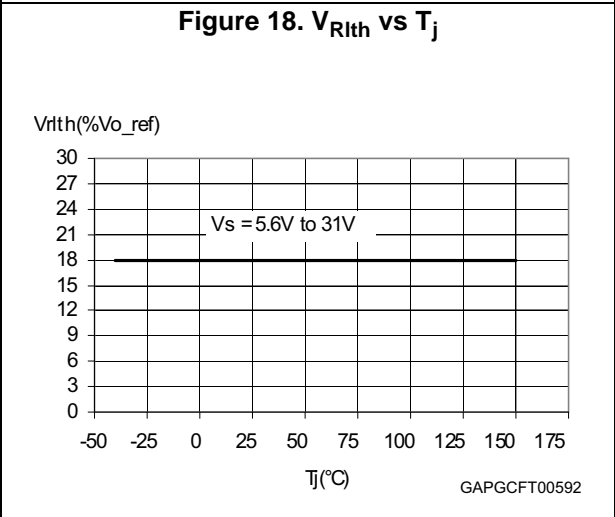
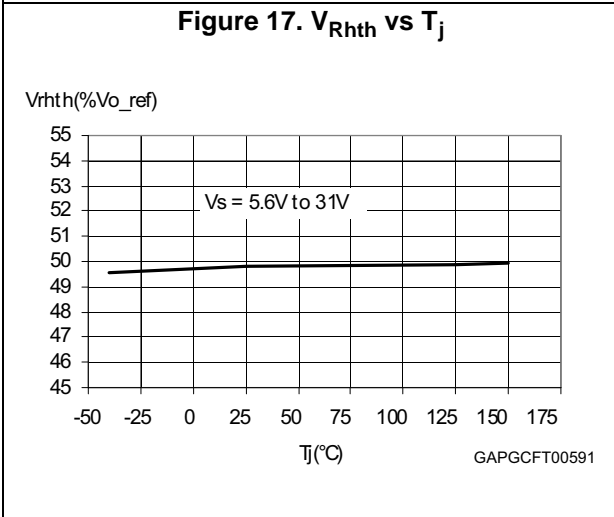
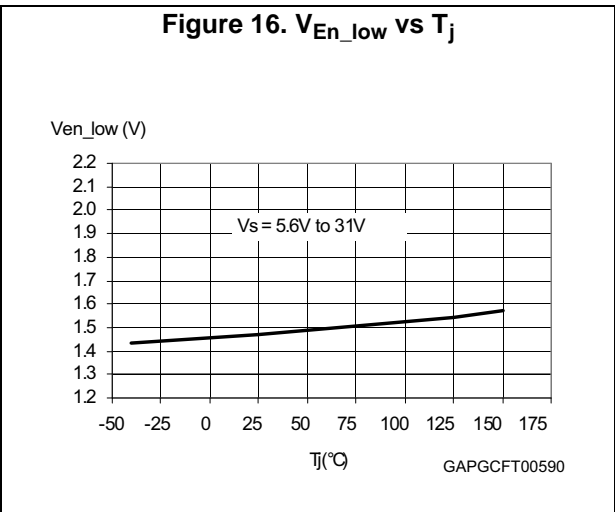
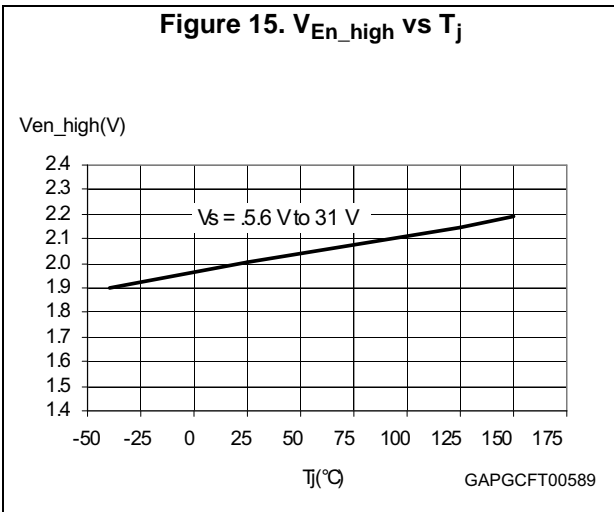


**Figure 13. Short-circuit current vs  $T_j$**



**Figure 14. Short-circuit current vs input voltage**





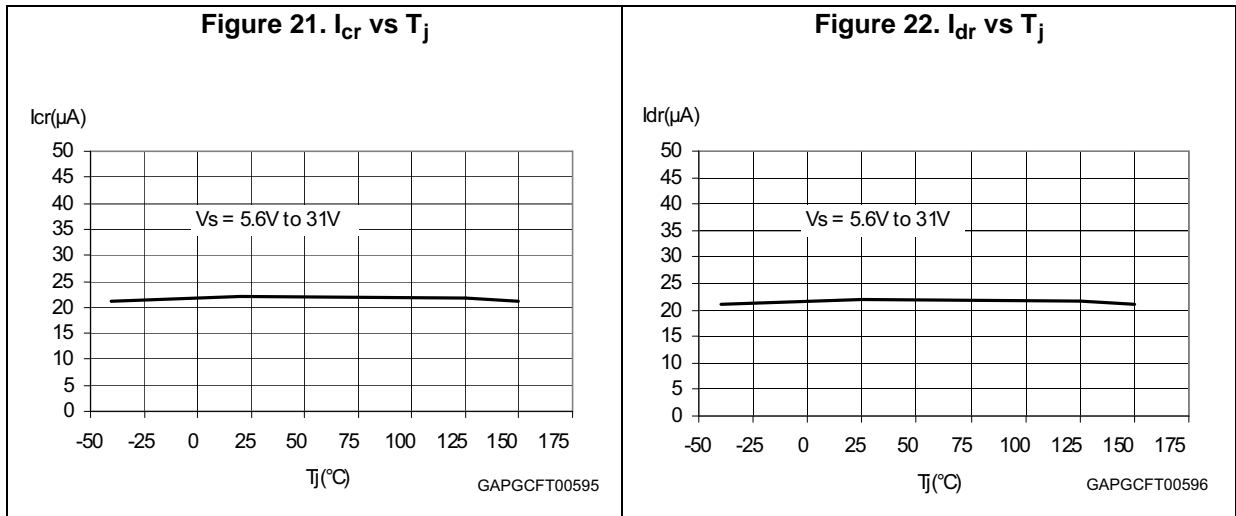




Figure 24. Stability region

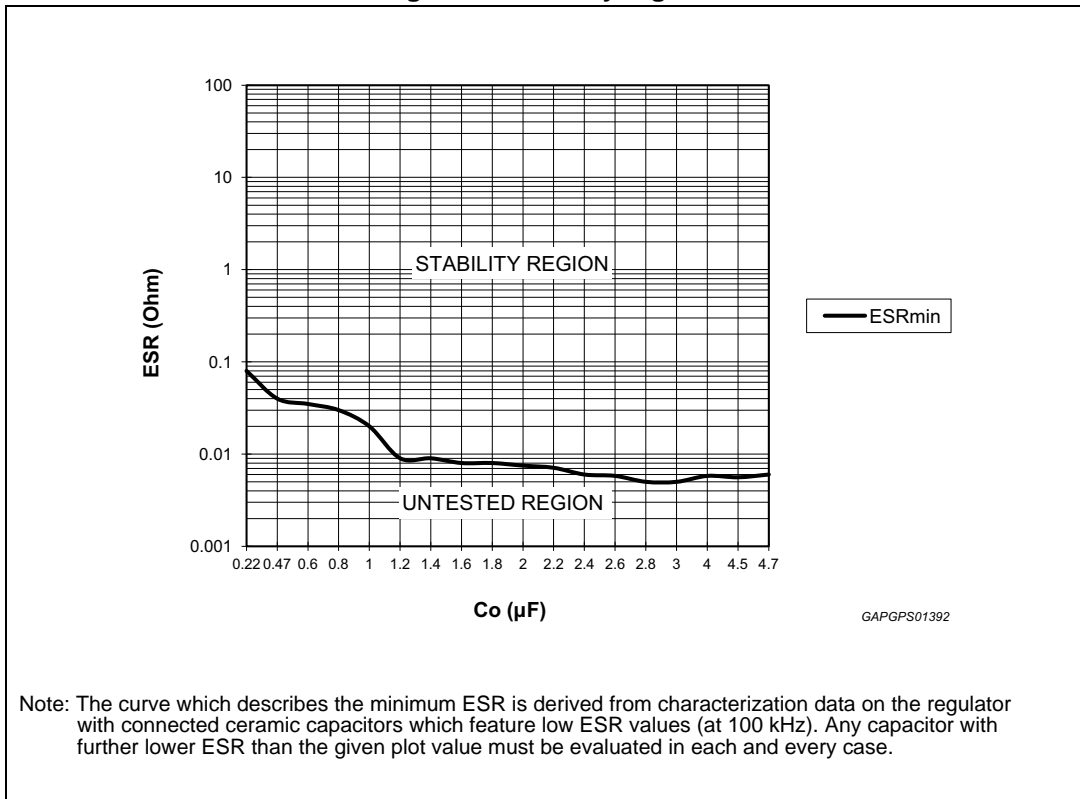
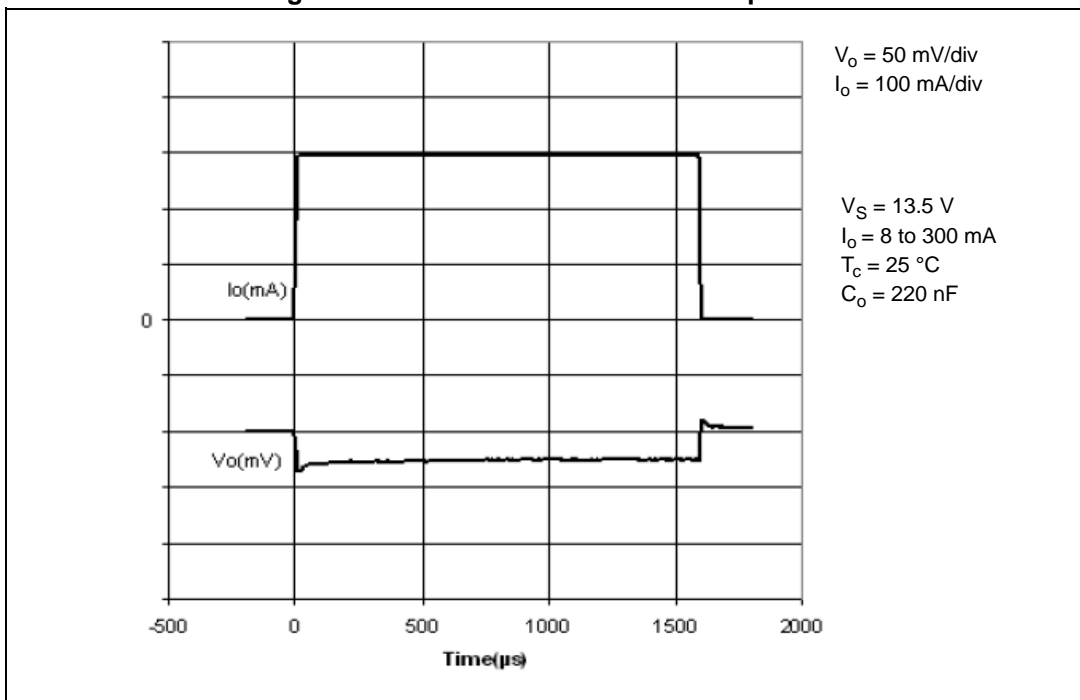


Figure 25. Maximum load variation response



### 3.2 Reset

The reset circuit monitors the output voltage  $V_o$ . If the output voltage becomes lower than  $V_{o\_th}$  then  $R_{es}$  goes low with a delay time ( $t_{rr}$ ). When the output voltage becomes higher than  $V_{o\_th}$  then  $R_{es}$  goes high with a delay time  $T_{rd}$ . This delay is obtained by 32 periods of oscillator.

The oscillator period is given by:

**Equation 1**

$$T_{osc} = [(V_{Rhth} - V_{Rlth}) \times C_{tr}] / I_{cr} + [(V_{Rhth} - V_{Rlth}) \times C_{tr}] / I_{dr}$$

where:

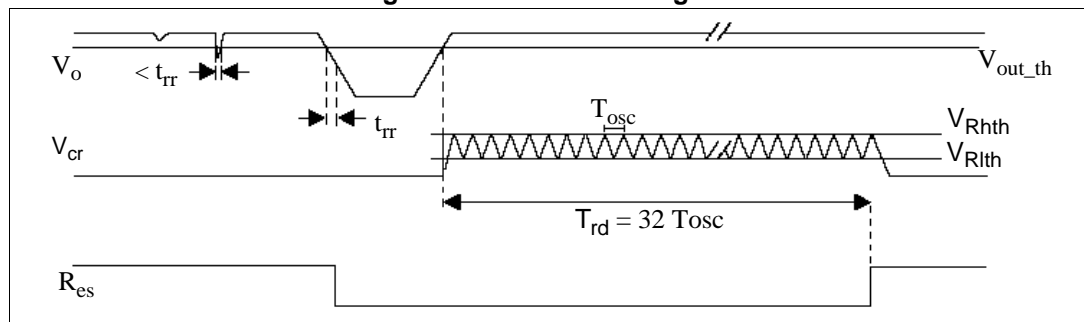
- $I_{cr} = 20 \mu A$  is an internally generated charge current,
- $I_{dr} = 20 \mu A$  is an internally generated discharge current,
- $V_{Rhth} = 2.5 V$  (typ) and  $V_{Rlth} = 0.95 V$  (typ) are two voltage thresholds,
- $C_{tr}$  is an external capacitor to be put between  $V_{cr}$  pin and GND.

Reset pulse delay  $T_{rd}$  is given by:

**Equation 2**

$$T_{rd} = 32 \times T_{osc}$$

**Figure 26. Reset time diagram**

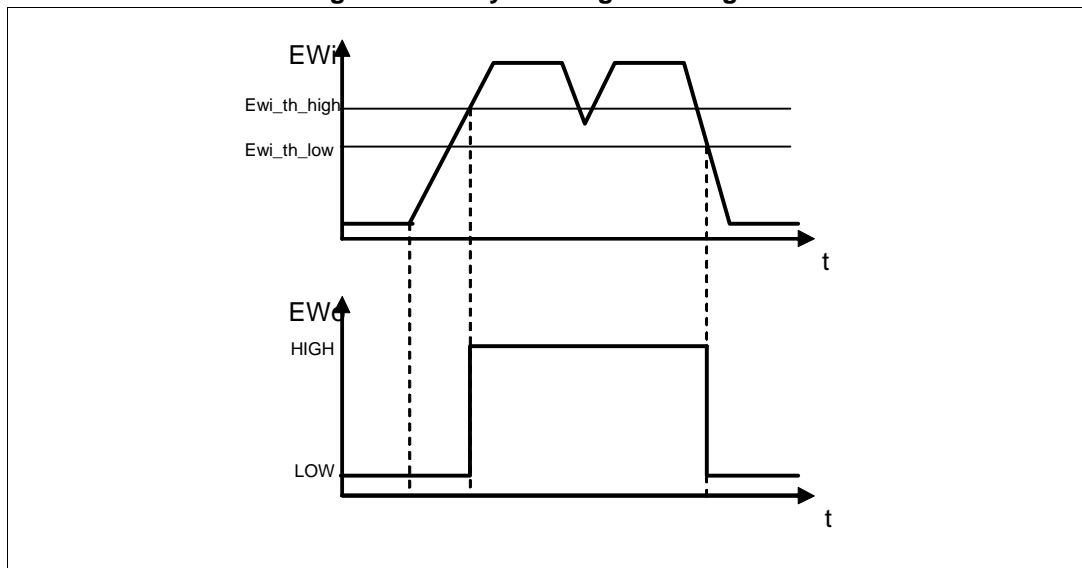


### 3.3 Early warning

This circuit compares the  $EW_i$  input signal with the internal voltage reference (typically 2.5 V). The use of an external voltage divider makes the comparator very flexible in the application. This function can be used to supervise the supply input voltage either before or after the protection diode and to give additional information to the microprocessor such as low voltage warnings.



Figure 27. Early warning time diagram

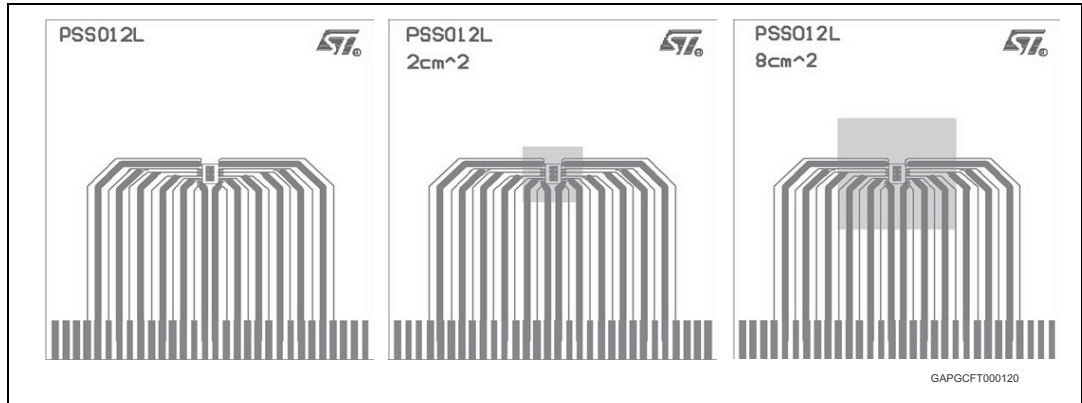


### 3.4 Enable

L5300GJ is also provided with an enable input, a high signal switches the regulator ON. In standby mode the output is disabled and the current consumption of the device (quiescent current) is less than 10  $\mu\text{A}$ .

## 4 Package and PCB thermal data

Figure 28. PowerSSO-12 PC board<sup>(1)</sup>



1. Layout condition of  $R_{th}$  and  $Z_{th}$  measurements (PCB: double layer, thermal vias, FR4 area = 77 mm x 86 mm, PCB thickness = 1.6 mm, Cu thickness = 70  $\mu$ m (front and back side), thermal vias separation 1.2 mm, thermal via diameter 0.3 mm +/- 0.08 mm, Cu thickness on vias 0.025 mm, Footprint dimension 4.1 mm x 6.5 mm ).

Figure 29.  $R_{thj-amb}$  Vs. PCB copper area in open box free air condition

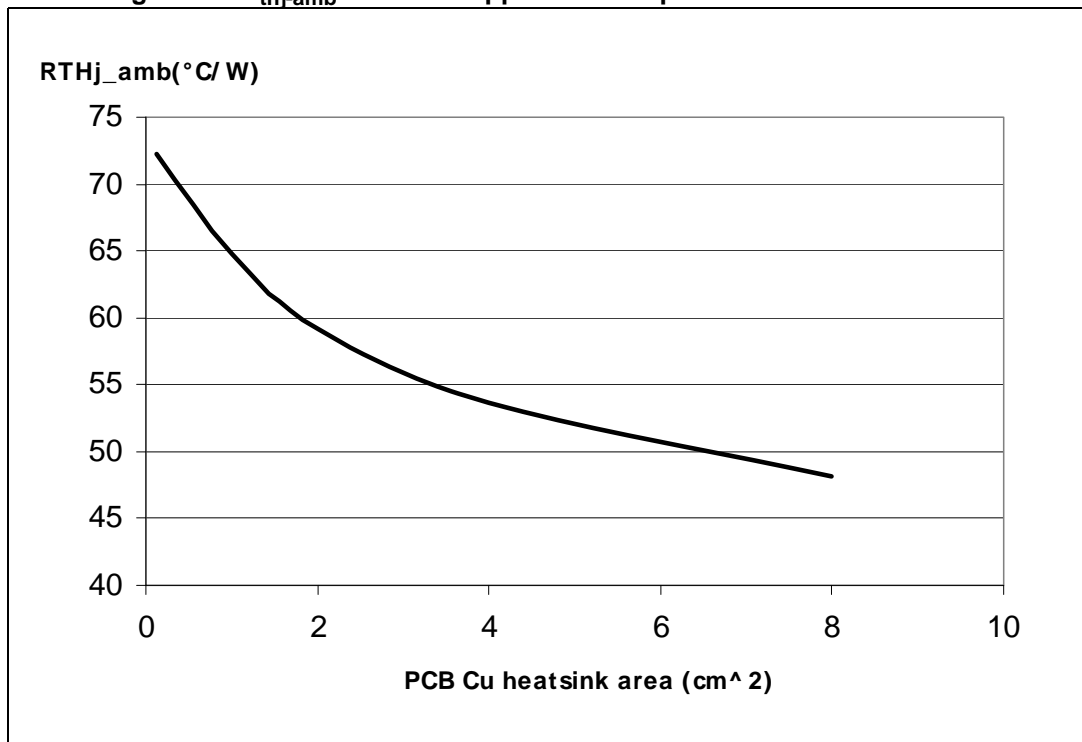
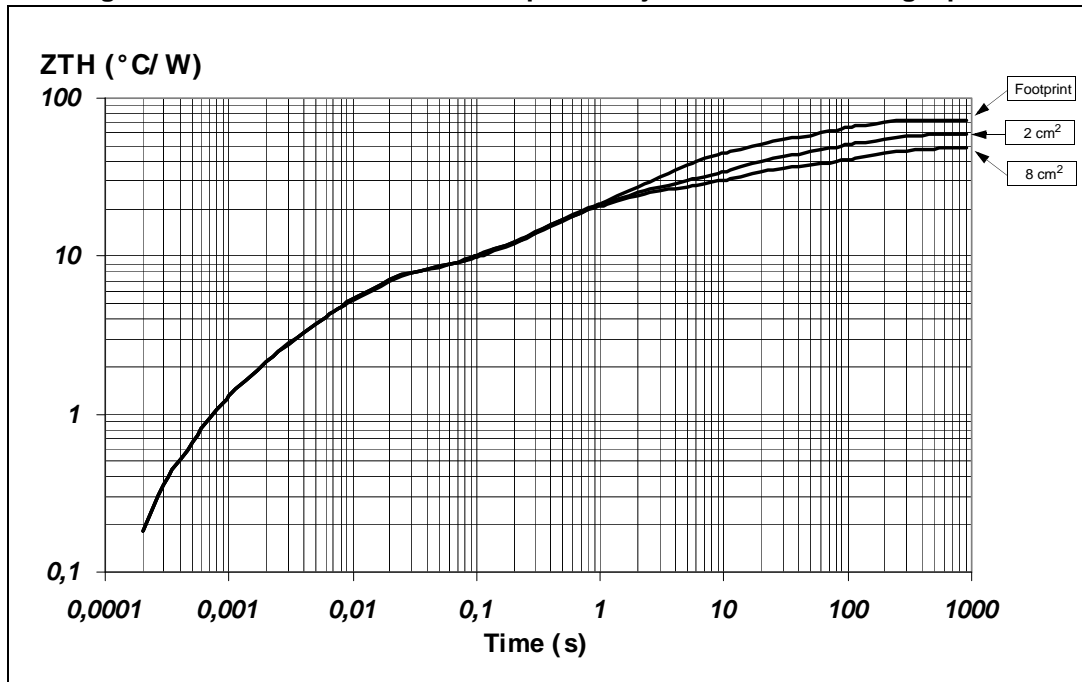


Figure 30. PowerSSO-12 thermal impedance junction ambient single pulse



Equation 3: pulse calculation formula

$$Z_{TH\delta} = R_{TH} \cdot \delta + Z_{THtp}(1 - \delta)$$

where  $\delta = t_p/T$

Figure 31. Thermal fitting model of Vreg in in PowerSSO-12

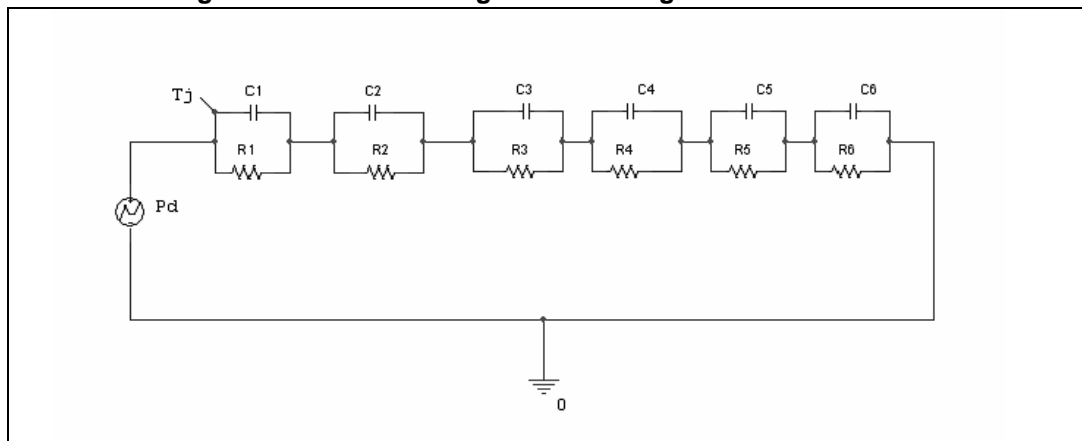


Table 9. PowerSSO-12 thermal parameter

Area (cm <sup>2</sup> )	Footprint	2	8
R1 (°C/W)	1.2		
R2 (°C/W)	6		
R3 (°C/W)	7		
R4 (°C/W)	10	10	9
R5 (°C/W)	22	15	10
R6 (°C/W)	26	20	15
C1 (W.s/°C)	0.0008		
C2 (W.s/°C)	0.0016		
C3 (W.s/°C)	0.05		
C4 (W.s/°C)	0.2	0.1	0.1
C5 (W.s/°C)	0.27	0.8	1
C6 (W.s/°C)	3	6	9

## 5 Package and packing information

### 5.1 ECOPACK®

In order to meet environmental requirements, ST offers these devices in different grades of ECOPACK® packages, depending on their level of environmental compliance. ECOPACK® specifications, grade definitions and product status are available at: [www.st.com](http://www.st.com). ECOPACK® is an ST trademark.

### 5.2 PowerSSO-12 mechanical data

Figure 32. PowerSSO-12 package dimensions

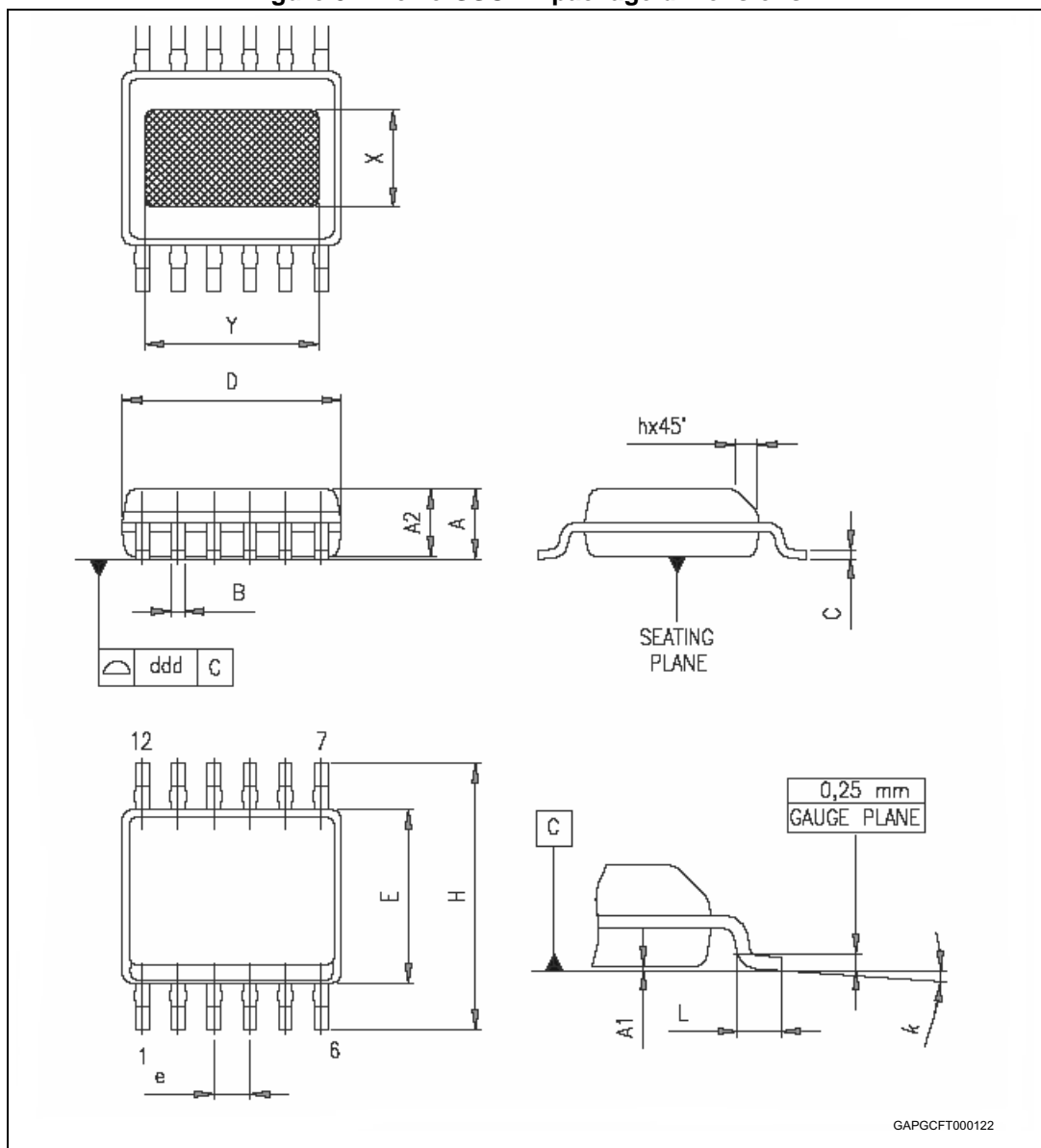


Table 10. PowerSSO-12 mechanical data

Symbol	Millimeters		
	Min.	Typ.	Max.
A	1.250		1.620
A1	0.000		0.100
A2	1.100		1.650
B	0.230		0.410
C	0.190		0.250
D	4.800		5.000
E	3.800		4.000
e		0.800	
H	5.800		6.200
h	0.250		0.500
L	0.400		1.270
k	0°		8°
X	2.200		2.800
Y	2.900		3.500
ddd			0.100

### 5.3 PowerSSO-12 packing information

Figure 33. PowerSSO-12 tube shipment (no suffix)

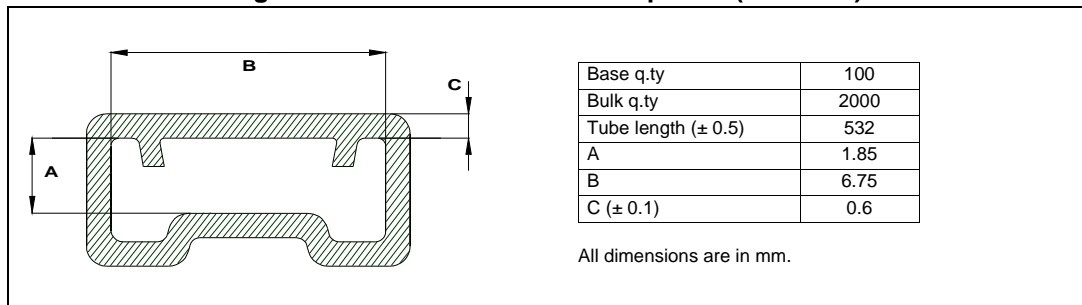
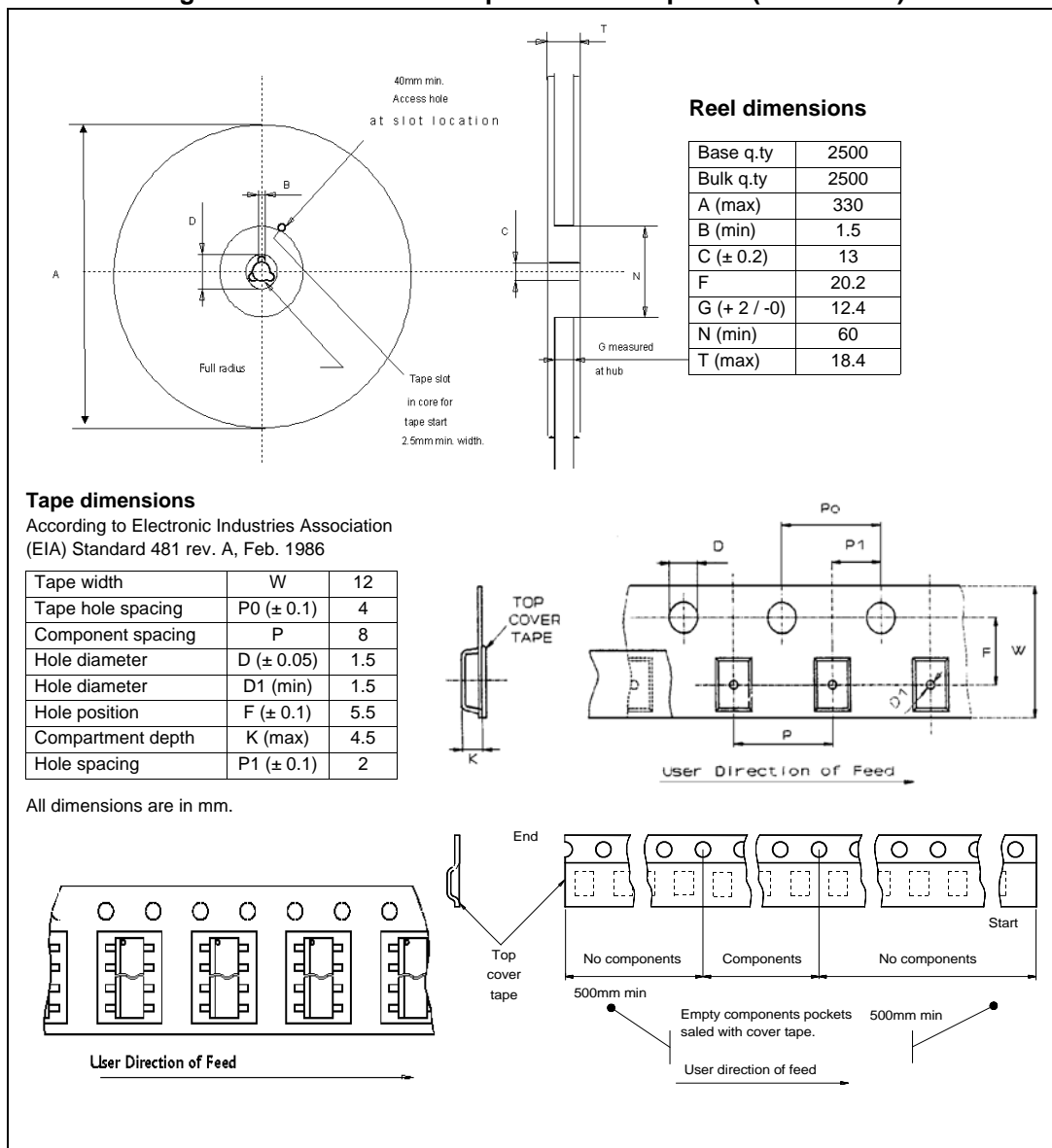


Figure 34. PowerSSO-12 tape and reel shipment (suffix "TR")



## 6 Revision history

**Table 11. Document revision history**

Date	Revision	Changes
09-Aug-2007	1	Initial release.
17-Sep-2008	2	<p>Changed rev. numbering according with new "Target" standard.  Updated quiescent currents on <a href="#">Features</a> table.  Updated <a href="#">Description</a> on cover page.  Changed <a href="#">Figure 1: Block diagram</a>.  Updated <a href="#">Figure 2: Configuration diagram (top view)</a>:  – added pin names.  Updated <a href="#">Table 2: Pins description</a>:  – changed pin 5 from NC to <math>V_{os}</math>  Added values to <a href="#">Table 4: Thermal data</a>.  Updated <a href="#">Table 5.: General</a>:  – updated test condition on <math>V_{o\_ref}</math>  – changed <math>I_{short}</math> values  – changed <math>I_{lim}</math> values  – updated test condition on <math>V_{line}</math>  – updated test condition on <math>V_{load}</math>  – Inserted <math>I_{oth\_H}</math>  – Inserted <math>I_{oth\_L}</math>  – Inserted <math>I_{oth\_Hyst}</math>  Updated <a href="#">Table 6: Reset</a>:  – updated test condition on <math>V_{res\_l}</math>  – updated test condition on <math>V_{o\_th}</math>  – changed <math>V_{Rlth}</math> values  – deleted test condition on <math>T_{rr}</math>  – changed <math>T_{rd}</math> values  Updated <a href="#">Table 7: Early warning</a>:  – updated test condition on <math>E_{Wo\_lv}</math>  – updated test condition on <math>I_{Wo}</math>  Updated <a href="#">Table 8: Enable</a>:  – changed typ. value on <math>V_{En\_hyst}</math>  – updated test condition on <math>I_{leak}</math>  Updated <a href="#">Chapter 3: Application information</a>  – deleted Figure 3: Behavior of output current versus regulated voltage <math>V_o</math>  – updated <a href="#">Section 3.2: Reset</a>  – updated <a href="#">Section 3.4: Enable</a>  Added <a href="#">Chapter 4: Package and PCB thermal data</a>.  Updated <a href="#">Table 10: PowerSSO-12 mechanical data</a>:  – changed slug dimensions  – <math>I_o = 1</math> to 300 mA</p>



Table 11. Document revision history (continued)

Date	Revision	Changes
13-Mar-2009	3	<p><a href="#">Table 2: Pins description</a></p> <ul style="list-style-type: none"> <li>– <math>V_{OS}</math>: changed function</li> </ul> <p><a href="#">Table 6: Reset</a></p> <ul style="list-style-type: none"> <li>– <math>I_{Res\_Ikg}</math>: deleted <math>V_{Res} = 5\text{ V}</math> from Test condition</li> <li>– <math>V_{O\_th}</math>: deleted <math>I_o = 1\text{ mA}</math> to <math>300\text{ mA}</math> from Test condition</li> <li>– <math>V_{Rlth}</math>: changed min/typ/max values</li> <li>– <math>T_{rd}</math>: changed min/typ/max values</li> </ul> <p><a href="#">Section 3.2: Reset</a></p> <ul style="list-style-type: none"> <li>– <math>V_{Rlth}</math>: changed coefficient</li> </ul> <p><a href="#">Section 3.4: Enable</a></p> <ul style="list-style-type: none"> <li>– Replaced <math>5\text{ }\mu\text{A}</math> with <math>10\text{ }\mu\text{A}</math></li> </ul>
07-Dec-2009	4	<p>Updated corporate template (from V2 to V3)</p> <p>Updated features list.</p> <p>Updated <a href="#">Figure 2: Configuration diagram (top view)</a></p> <p><a href="#">Table 2: Pins description</a></p> <ul style="list-style-type: none"> <li>– Added new row</li> </ul> <p><a href="#">Table 5: General</a></p> <ul style="list-style-type: none"> <li>– <math>I_{short}</math>: changed min/typ/max value</li> <li>– <math>I_{lim}</math>: changed min/typ/max value</li> <li>– <math>V_{line}</math>: changed Test conditions</li> <li>– <math>V_{load}</math>: changed max value for <math>V_s = 8\text{ V}</math> to <math>18\text{ V}</math>, added new row</li> </ul> <p><a href="#">Table 6: Reset</a></p> <ul style="list-style-type: none"> <li>– <math>V_{Rlth}</math>: changed min/typ value</li> </ul> <p><a href="#">Table 8: Enable</a></p> <ul style="list-style-type: none"> <li>– <math>I_{leak}</math>: changed typ value</li> </ul> <p><a href="#">Section 3.3: Early warning</a></p> <ul style="list-style-type: none"> <li>– changed typical internal voltage reference value (from <math>1.23\text{ V}</math> to <math>2.5\text{ V}</math>)</li> </ul> <p>Added <a href="#">Section 2.4: Electrical characteristics curves</a>.</p> <p>Updated <a href="#">Chapter 3.1: Voltage regulator</a>.</p>
27-Jan-2012	5	Updated <a href="#">Figure 23: Application schematic</a> and <a href="#">Figure 24: Stability region</a> .
07-Feb-2012	6	Modified <a href="#">Figure 24: Stability region on page 15</a> .
19-Sep-2013	7	Updated disclaimer.
26-Sep-2018	8	Updated template. Updated <a href="#">Features</a> and title.

**IMPORTANT NOTICE – PLEASE READ CAREFULLY**

STMicroelectronics NV and its subsidiaries ("ST") reserve the right to make changes, corrections, enhancements, modifications, and improvements to ST products and/or to this document at any time without notice. Purchasers should obtain the latest relevant information on ST products before placing orders. ST products are sold pursuant to ST's terms and conditions of sale in place at the time of order acknowledgement.

Purchasers are solely responsible for the choice, selection, and use of ST products and ST assumes no liability for application assistance or the design of Purchasers' products.

No license, express or implied, to any intellectual property right is granted by ST herein.

Resale of ST products with provisions different from the information set forth herein shall void any warranty granted by ST for such product.

ST and the ST logo are trademarks of ST. All other product or service names are the property of their respective owners.

Information in this document supersedes and replaces information previously supplied in any prior versions of this document.

© 2018 STMicroelectronics – All rights reserved

Компания «Океан Электроники» предлагает заключение долгосрочных отношений при поставках импортных электронных компонентов на взаимовыгодных условиях!

Наши преимущества:

- Поставка оригинальных импортных электронных компонентов напрямую с производств Америки, Европы и Азии, а так же с крупнейших складов мира;
- Широкая линейка поставок активных и пассивных импортных электронных компонентов (более 30 млн. наименований);
- Поставка сложных, дефицитных, либо снятых с производства позиций;
- Оперативные сроки поставки под заказ (от 5 рабочих дней);
- Экспресс доставка в любую точку России;
- Помощь Конструкторского Отдела и консультации квалифицированных инженеров;
- Техническая поддержка проекта, помощь в подборе аналогов, поставка прототипов;
- Поставка электронных компонентов под контролем ВП;
- Система менеджмента качества сертифицирована по Международному стандарту ISO 9001;
- При необходимости вся продукция военного и аэрокосмического назначения проходит испытания и сертификацию в лаборатории (по согласованию с заказчиком);
- Поставка специализированных компонентов военного и аэрокосмического уровня качества (Xilinx, Altera, Analog Devices, Intersil, Interpoint, Microsemi, Actel, Aeroflex, Peregrine, VPT, Syfer, Eurofarad, Texas Instruments, MS Kennedy, Miteq, Cobham, E2V, MA-COM, Hittite, Mini-Circuits, General Dynamics и др.);

Компания «Океан Электроники» является официальным дистрибьютором и эксклюзивным представителем в России одного из крупнейших производителей разъемов военного и аэрокосмического назначения «JONHON», а так же официальным дистрибьютором и эксклюзивным представителем в России производителя высокотехнологичных и надежных решений для передачи СВЧ сигналов «FORSTAR».



## JONHON

«JONHON» (основан в 1970 г.)

Разъемы специального, военного и аэрокосмического назначения:

(Применяются в военной, авиационной, аэрокосмической, морской, железнодорожной, горно- и нефтедобывающей отраслях промышленности)

«FORSTAR» (основан в 1998 г.)

ВЧ соединители, коаксиальные кабели, кабельные сборки и микроволновые компоненты:

(Применяются в телекоммуникациях гражданского и специального назначения, в средствах связи, РЛС, а так же военной, авиационной и аэрокосмической отраслях промышленности).



Телефон: 8 (812) 309-75-97 (многоканальный)

Факс: 8 (812) 320-03-32

Электронная почта: [ocean@oceanchips.ru](mailto:ocean@oceanchips.ru)

Web: <http://oceanchips.ru/>

Адрес: 198099, г. Санкт-Петербург, ул. Калинина, д. 2, корп. 4, лит. А