

Serial EEPROM Standard EEPROM  
WLCSP EEPROM



# BU9832GUL-W (8Kbit)

●General Description

BU9832GUL-W is a serial EEPROM of SPI BUS interface method.

●Features

- High speed clock action up to 5MHz (Max.)
- Wait function by HOLD terminal.
- Part or whole of memory arrays settable as read only memory area by program.
- 1.8 to 5.5V single power source action most suitable for battery use.
- Page write mode useful for initial value write at factory shipment.
- For SPI bus interface (CPOL, CPHA) = (0, 0), (1, 1)
- Auto erase and auto end function at data rewrite.
- Low current consumption
  - At write action (5V) : 1.5mA (Typ.)
  - At read action (5V) : 1.0mA (Typ.)
  - At standby action (5V) : 0.1μA (Typ.)
- Address auto increment function at read action
- Write mistake prevention function
  - Write prohibition at power on.
  - Write prohibition by command code (WRDI).
  - Write prohibition by WP pin.
  - Write prohibition block setting by status registers (BP1, BP0)
  - Write mistake prevention function at low voltage.
- Compact package
  - W(Typ.) x D(Typ.) x H(Max.) : 2.09mm x 1.85mm x 0.55mm
- Data at shipment Memory array: FFh, status register WPEN, BP1, BP0 : 0
- Data kept for 40 years.
- Data rewrite up to 1,000,000times.

●Page write

| Product number | Number of pages |
|----------------|-----------------|
| BU9832GUL-W    | 32 Byte         |

●BU9832GUL-W

| Type        | Capacity | Bit format | Power source voltage | Package  |
|-------------|----------|------------|----------------------|----------|
| BU9832GUL-W | 8Kbit    | 1Kx8       | 1.8V to 5.5V         | VCSP50L2 |

**● Absolute Maximum Ratings (Ta=25°C)**

| Parameter                   | Symbol | Ratings         | Unit | Remarks  |
|-----------------------------|--------|-----------------|------|--|
| Impressed voltage           | Vcc    | -0.3 to +6.5    | V    |  |
| Permissible dissipation     | Pd     | 220(VCSP50L2)   | mW   | When using at Ta=25°C or higher, 220mW to be reduced per 1°C |
| Storage Temperature range   | Tstg   | -65 to +125     | °C   |  |
| Operating Temperature range | Topr   | -40 to +85      | °C   |  |
| Terminal voltage            | —      | -0.3 to Vcc+0.3 | V    |  |

**● Memory cell characteristics (Ta=25°C, Vcc=1.8V to 5.5V)**

| Parameter                       | Limits    |      |     | Unit  |
|---------------------------------|-----------|------|-----|-------|
|                                 | Min.      | Typ. | Max |       |
| Number of data rewrite times *1 | 1,000,000 | —    | —   | Times |
| Data hold years *1              | 40        | —    | —   | Years |

\*1 Not 100% TESTED

**● Recommended Operating Ratings**

| Parameter            | Symbol | Ratings    | Unit |
|----------------------|--------|------------|------|
| Power source voltage | Vcc    | 1.8 to 5.5 | V    |
| Input voltage        | VIN    | 0 to Vcc   |      |

**● Input / output capacity (Ta=25°C, frequency=5MHz)**

| Parameter          | Symbol | Limits |     | Unit | Conditions |
|--------------------|--------|--------|-----|------|------------|
|                    |        | Min.   | Max |      |            |
| Input capacity *1  | CIN    | —      | 8   | pF   | VIN=GND    |
| Output capacity *1 | COU    | —      | 8   | pF   | VOUT=GND   |

\*1 : Not 100% TESTED

**● Electrical characteristics (Unless otherwise specified, Ta=-40°C to +85°C, Vcc=1.8V to 5.5V)**

| Parameter                           | Symbol | Limits  |      |         | Unit | Conditions   |
|-------------------------------------|--------|---------|------|---------|------|--|
|                                     |        | Min.    | Typ. | Max.    |      |  |
| "H" input voltage 1                 | VIH1   | 0.7xVcc | —    | Vcc+0.3 | V    | 1.8 ≤ Vcc ≤ 5.5V   |
| "L" input voltage 1                 | VIL1   | -0.3    | —    | 0.3xVcc | V    | 1.8 ≤ Vcc ≤ 5.5V   |
| "L" output voltage 1                | VOL1   | 0       | —    | 0.4     | V    | IOL=2.1mA(Vcc=2.5V to 5.5V)  |
| "L" output voltage 2                | VOL2   | 0       | —    | 0.2     | V    | IOL=150μA(Vcc=1.8V to 2.5V)  |
| "H" output voltage 1                | VOH1   | Vcc-0.5 | —    | Vcc     | V    | IOH=-0.4mA(Vcc=2.5V to 5.5V)   |
| "H" output voltage 2                | VOH2   | Vcc-0.2 | —    | Vcc     | V    | IOH=-100μA(Vcc=1.8V to 2.5V)   |
| Input leak current                  | ILI    | -1      | —    | 1       | μA   | VIN=0 to Vcc   |
| Output leak current                 | ILO    | -1      | —    | 1       | μA   | VOUT=0 to Vcc, CS=Vcc  |
| Current consumption at write action | ICC1   | —       | —    | 1.0     | mA   | Vcc=1.8V, fSCK=2MHz, tE/W=5ms<br>Byte write, Page write, Write status register |
|                                     | ICC2   | —       | —    | 2.0     | mA   | Vcc=2.5V, fSCK=5MHz, tE/W=5ms<br>Byte write, Page write, Write status register |
|                                     | ICC3   | —       | —    | 3.0     | mA   | Vcc=5.5V, fSCK=5MHz, tE/W=5ms<br>Byte write, Page write, Write status register |
| Current consumption at read action  | ICC4   | —       | —    | 1.5     | mA   | Vcc=2.5V, fSCK=5MHz<br>Read, Read status register                              |
|                                     | ICC5   | —       | —    | 2.0     | mA   | Vcc=5.5V, fSCK=5MHz<br>Read, Read status register                              |
| Standby current                     | ISB    | —       | —    | 2       | μA   | Vcc=5.5V, CS=HOLD=WP=Vcc<br>SCK=SI=Vcc or=GND, SO=OPEN                         |

### ● Operating timing characteristics

(Ta=-40°C to +85°C, unless otherwise specified, load capacity C<sub>L1</sub>=100pF)

| Parameter   | Symbol | 1.8≤V <sub>cc</sub> < 2.5V |      |      | 2.5≤V <sub>cc</sub> < 5.5V |      |      | Unit |
|---|--------|----------------------------|------|------|----------------------------|------|------|------|
|   |        | Min.                       | Typ. | Max. | Min.                       | Typ. | Max. |      |
| SCK frequency                                       | fSCK   | –                          | –    | 2    | –                          | –    | 5    | MHz  |
| SCK high time                                       | tSCKWH | 200                        | –    | –    | 85                         | –    | –    | ns   |
| SCK low time  | tSCKWL | 200                        | –    | –    | 85                         | –    | –    | ns   |
| $\overline{\text{CS}}$ high time                    | tCS    | 200                        | –    | –    | 85                         | –    | –    | ns   |
| $\overline{\text{CS}}$ setup time                   | tCSS   | 200                        | –    | –    | 90                         | –    | –    | ns   |
| $\overline{\text{CS}}$ hold time                    | tCSH   | 200                        | –    | –    | 85                         | –    | –    | ns   |
| SCK setup time                                      | tSCKS  | 200                        | –    | –    | 90                         | –    | –    | ns   |
| SCK hold time                                       | tSCKH  | 200                        | –    | –    | 90                         | –    | –    | ns   |
| SI setup time                                       | tDIS   | 40                         | –    | –    | 20                         | –    | –    | ns   |
| SI hold time  | tDIH   | 50                         | –    | –    | 40                         | –    | –    | ns   |
| Data output delay time1                             | tPD1   | –                          | –    | 150  | –                          | –    | 70   | ns   |
| Data output delay time2 (C <sub>L2</sub> =30pF)     | tPD2   | –                          | –    | 145  | –                          | –    | 55   | ns   |
| Output hold time                                    | tOH    | 0                          | –    | –    | 0                          | –    | –    | ns   |
| Output disable time                                 | tOZ    | –                          | –    | 250  | –                          | –    | 100  | ns   |
| $\overline{\text{HOLD}}$ setting setup time         | tHFS   | 120                        | –    | –    | 60                         | –    | –    | ns   |
| $\overline{\text{HOLD}}$ setting hold time          | tHFH   | 90                         | –    | –    | 40                         | –    | –    | ns   |
| $\overline{\text{HOLD}}$ release setup time         | tHRS   | 120                        | –    | –    | 60                         | –    | –    | ns   |
| $\overline{\text{HOLD}}$ release hold time          | tHRH   | 140                        | –    | –    | 70                         | –    | –    | ns   |
| Time from $\overline{\text{HOLD}}$ to output High-Z | tHOZ   | –                          | –    | 250  | –                          | –    | 100  | ns   |
| Time from $\overline{\text{HOLD}}$ To output change | tHPD   | –                          | –    | 150  | –                          | –    | 70   | ns   |
| SCK rise time *1                                    | tRC    | –                          | –    | 1    | –                          | –    | 1    | μs   |
| SCK fall time *1                                    | tFC    | –                          | –    | 1    | –                          | –    | 1    | μs   |
| Output rise time *1                                 | tRO    | –                          | –    | 100  | –                          | –    | 50   | ns   |
| Output fall time *1                                 | tFO    | –                          | –    | 100  | –                          | –    | 50   | ns   |
| Write time  | tE/W   | –                          | –    | 5    | –                          | –    | 5    | ms   |

\*1 NOT 100% TESTED

### ● AC measurement conditions

| Parameter                       | Symbol          | Limits                                 |      |      | Unit |
|---------------------------------|-----------------|--|------|------|------|
|                                 |                 | Min.                                   | Typ. | Max. |      |
| Load capacity 1                 | C <sub>L1</sub> | –                                      | –    | 100  | pF   |
| Load capacity 2                 | C <sub>L2</sub> | –                                      | –    | 30   | pF   |
| Input rise time                 | –               | –                                      | –    | 50   | ns   |
| Input fall time                 | –               | –                                      | –    | 50   | ns   |
| Input voltage                   | –               | 0.2V <sub>cc</sub> /0.8V <sub>cc</sub> |      |      | V    |
| Input / Output judgment voltage | –               | 0.3V <sub>cc</sub> /0.7V <sub>cc</sub> |      |      | V    |

● Sync data input / output timing

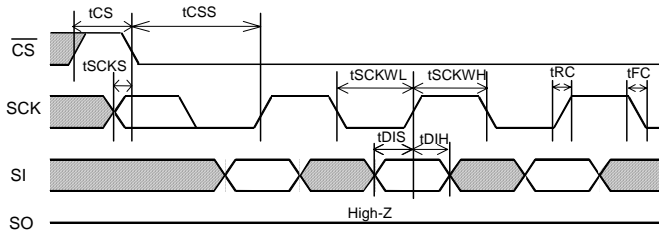

Figure 1. Input timing

SI is taken into IC inside in sync with data rise edge of SCK. Input address and data from the most significant bit MSB.

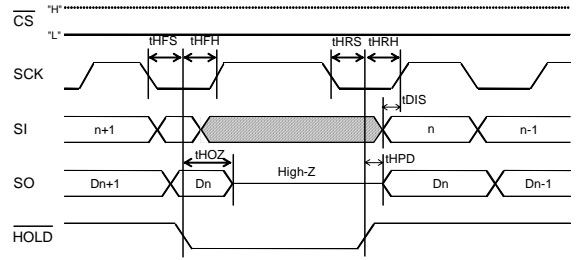

Figure 3. HOLD timing

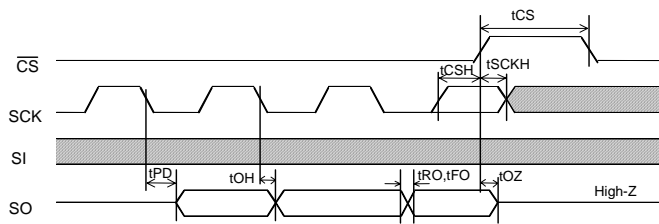
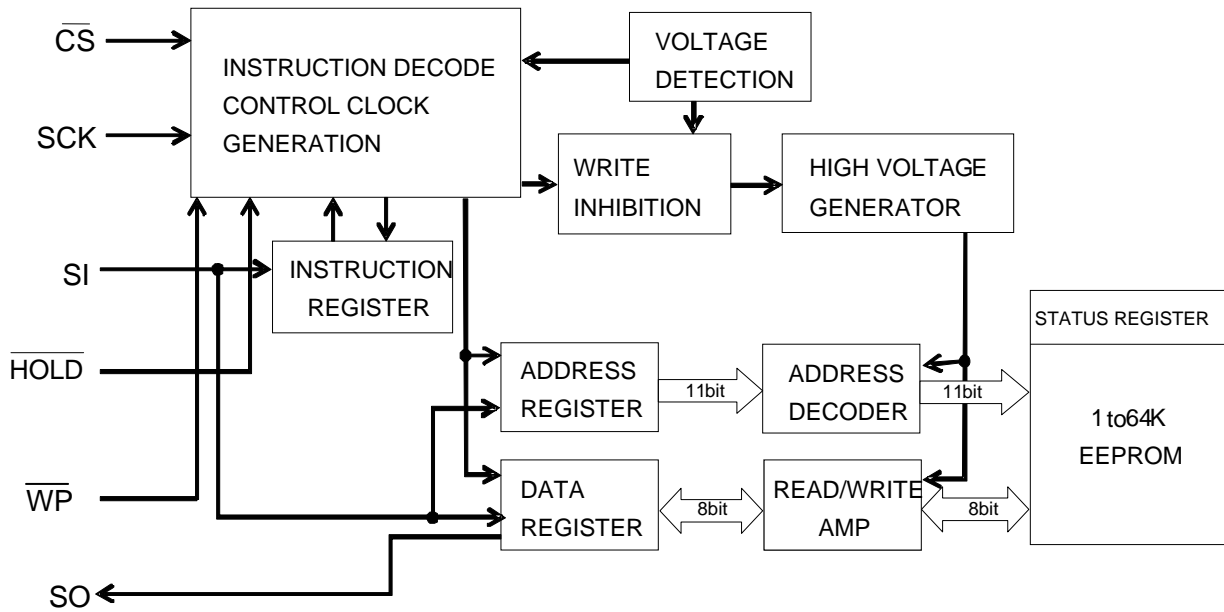

Figure 2. Input / Output timing

SO is output in sync with data fall edge of SCK. Data is output from the most significant bit MSB.

●Block Diagram



●Pin Configuration

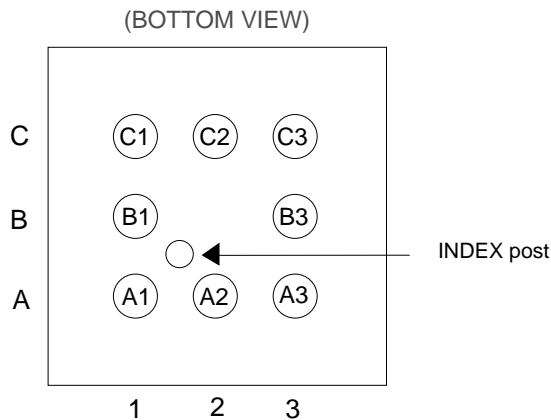

●Pin Descriptions

| Land No. | Terminal name            | Input/ Output | Function   |
|----------|--------------------------|---------------|--|
| A1       | $\overline{\text{WP}}$   | Input         | Write protect input<br>Write status register command is prohibited.            |
| A2       | GND                      | -             | All input / output reference voltage, 0V                                       |
| A3       | SI                       | Input         | Start bit, ope code, address, and serial data input                            |
| B1       | SO                       | Output        | Serial data output   |
| B3       | SCK                      | Input         | Serial clock input   |
| C1       | $\overline{\text{CS}}$   | Input         | Chip select input  |
| C2       | Vcc                      | -             | Power source to be connected   |
| C3       | $\overline{\text{HOLD}}$ | Input         | Hold input<br>Command communication may be suspended temporarily (HOLD status) |

● Typical Performance Curves

(The following characteristics data are Typ. Values.)

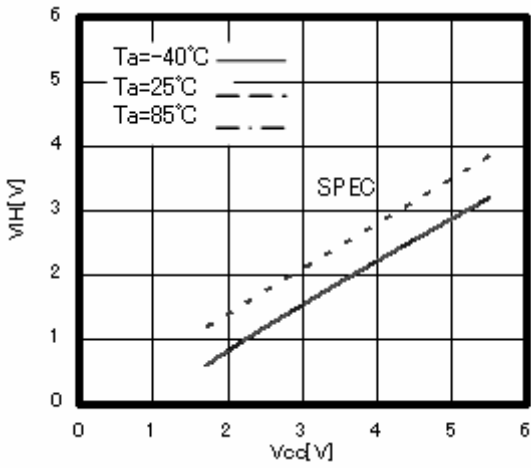

Figure 4. "H" input voltage  $V_{IH}$  ( $\overline{CS}$ ,  $\overline{SCK}$ ,  $\overline{SI}$ ,  $\overline{HOLD}$ ,  $\overline{WP}$ )

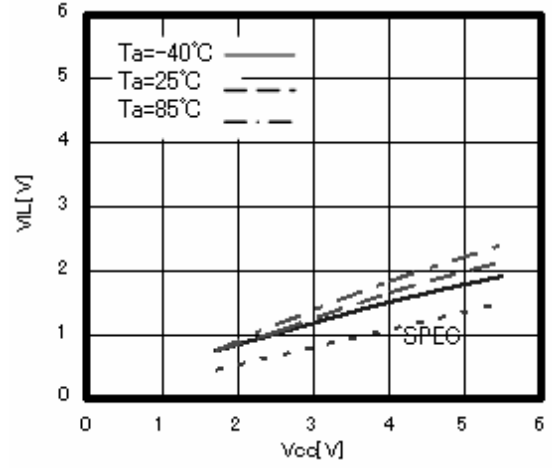

Figure 5. "L" input voltage  $V_{IL}$  ( $\overline{CS}$ ,  $\overline{SCK}$ ,  $\overline{SI}$ ,  $\overline{HOLD}$ ,  $\overline{WP}$ )

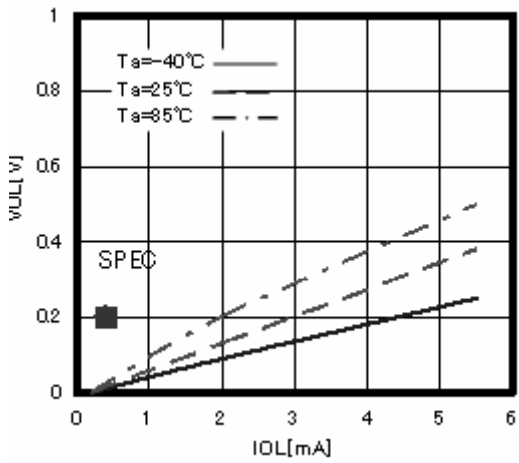

Figure 6. "L" output voltage  $V_{OL-IOL}$  ( $V_{CC}=1.8V$ )

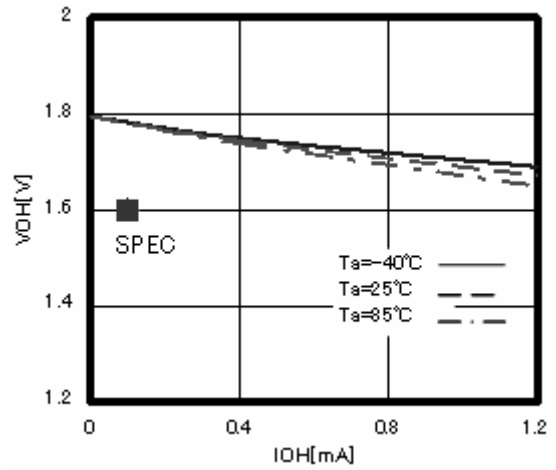

Figure 7. "H" output voltage  $V_{OH-IOH}$  ( $V_{CC}=1.8V$ )

● Typical Performance Curves - Continued

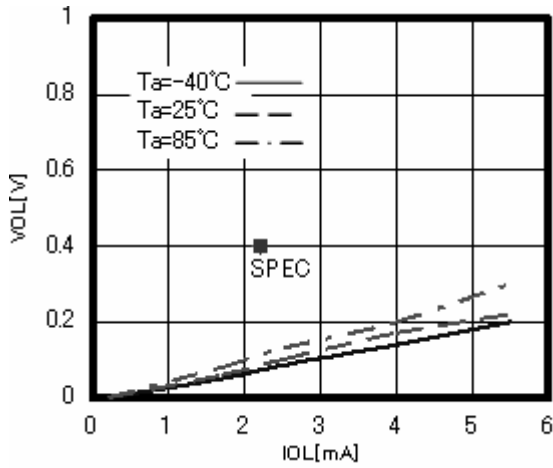

Figure 8. "L" output voltage VOL-IOL (Vcc=2.5V)

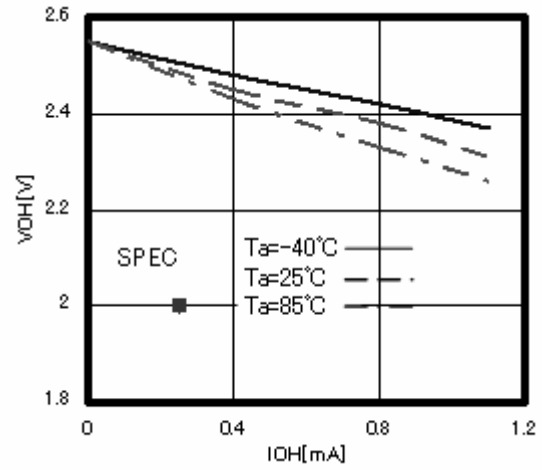

Figure 9. "H" output voltage VOH-IOH (Vcc=2.5V)

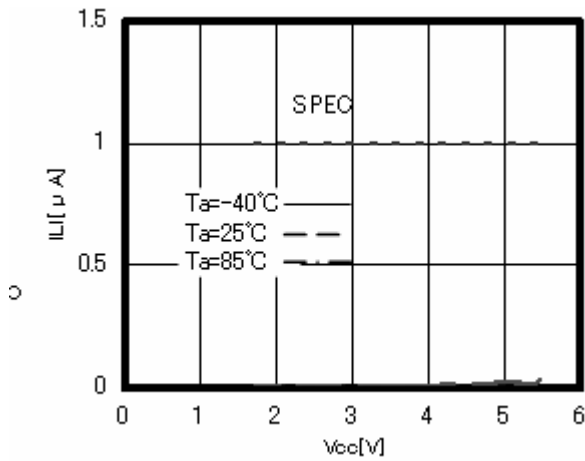

Figure 10. Input leak current ILI (CS, SCK, SI, HOLD, WP)

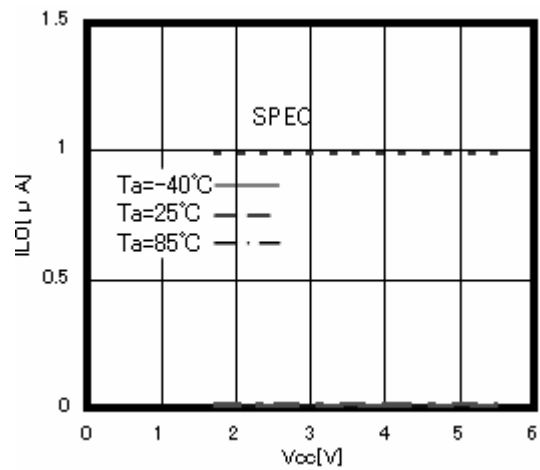

Figure 11. Output leak current ILO (SO)

● Typical Performance Curves - Continued

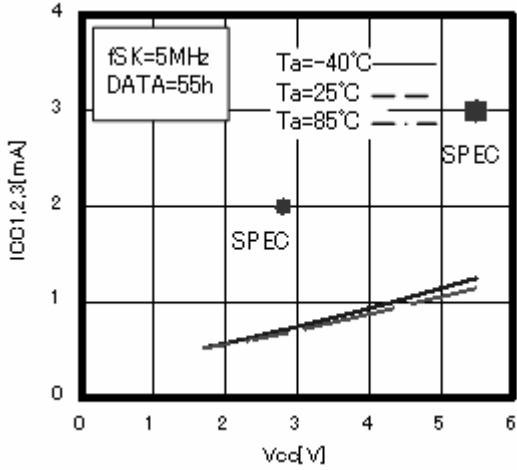

Figure 12. Current consumption at WRITE operation ICC1, 2, 3 (WRITE, PAGE WRITE, WRSR, fSK=5MHz)

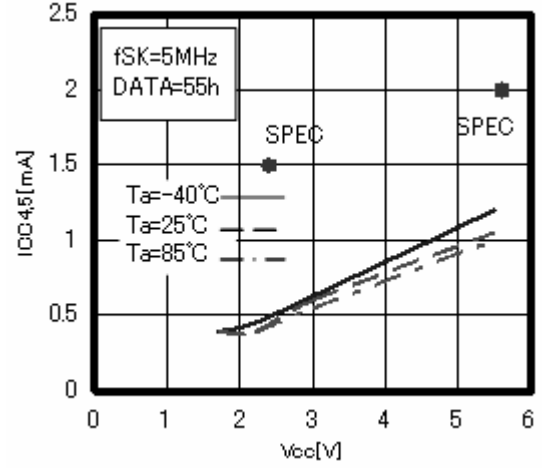

Figure 13. Consumption current at READ operation ICC4, 5 (READ, WRSR, fSK=5MHz)

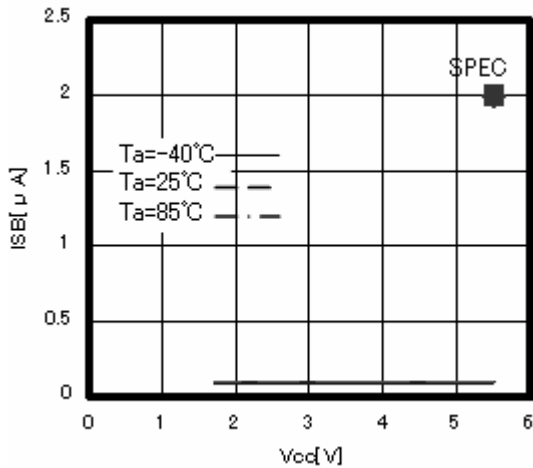

Figure 14. Consumption current at standby operation ISB

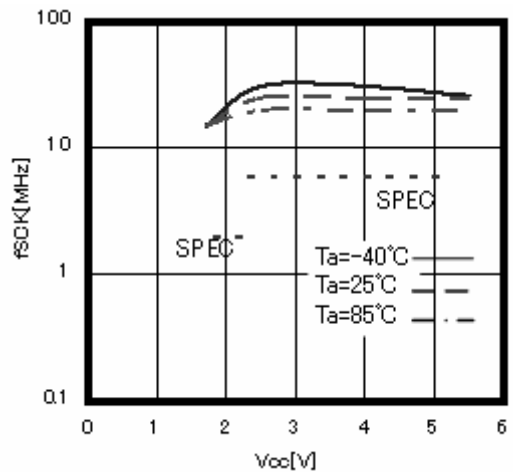

Figure 15. SCK frequency fSK



● Typical Performance Curves - Continued

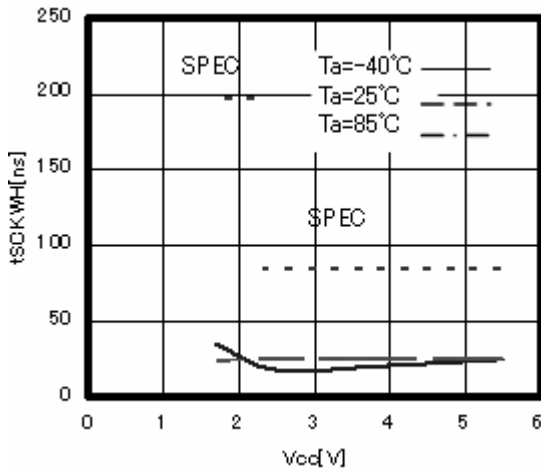

Figure 16. tSCK high time tSCKWH

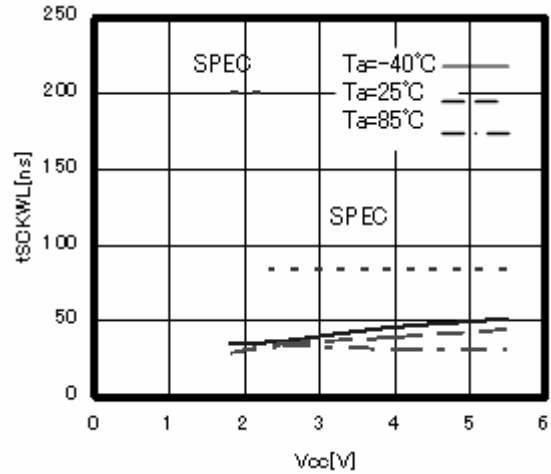

Figure 17. tSCK low time tSCKWL

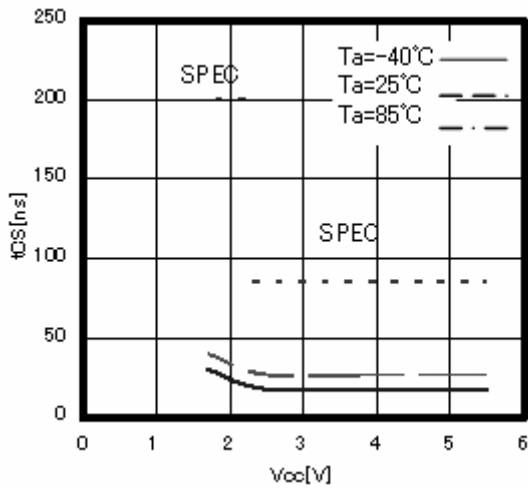

Figure 18.  $\overline{CS}$  high time tCS

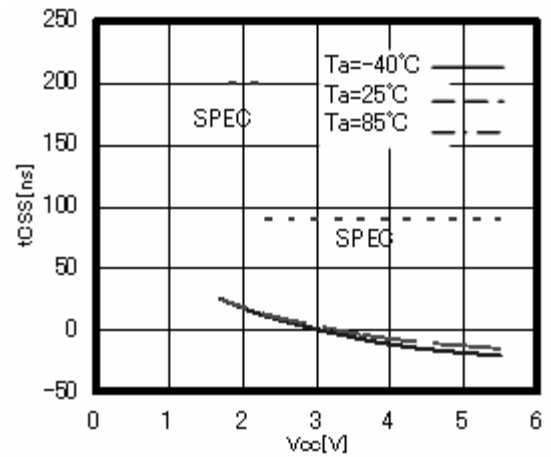

Figure 19.  $\overline{CS}$  setup time tCSS

● Typical Performance Curves - Continued

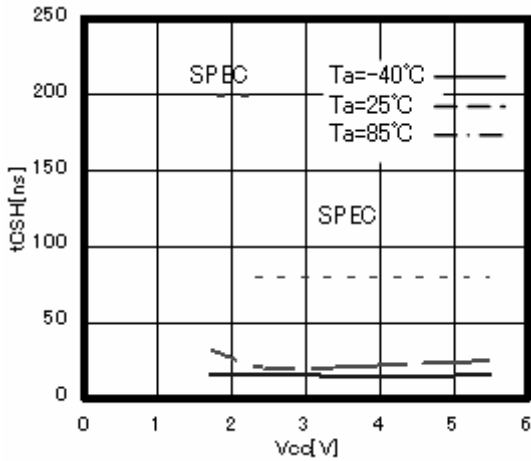

Figure 20. CS hold time  $t_{CSH}$

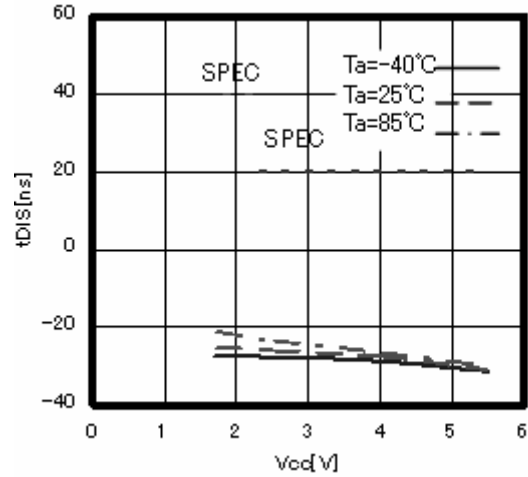

Figure 21. SI setup time  $t_{DIS}$

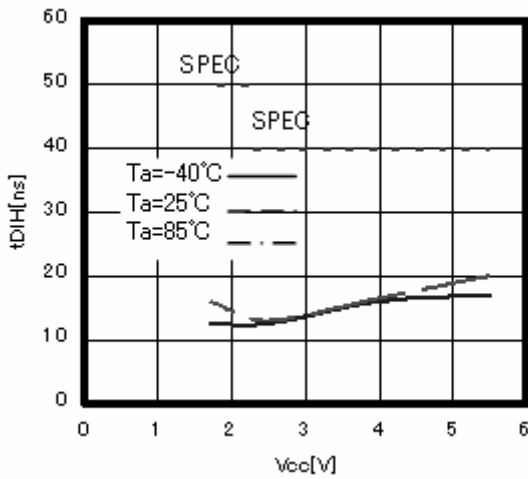

Figure 22. SI hold time  $t_{DIH}$

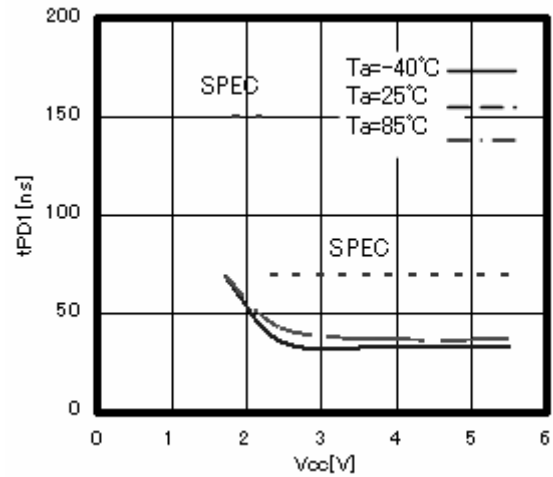

Figure 23. Data output delay time  $t_{PD1}$  ( $C_L=100pF$ )

● Typical Performance Curves - Continued

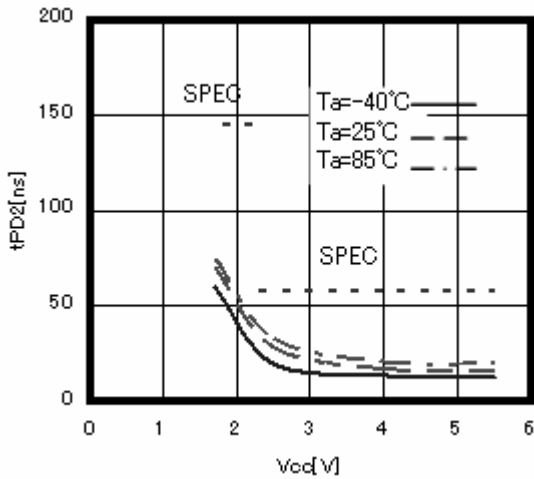

Figure 24. Data output delay time tPD2 (CL=30pF)

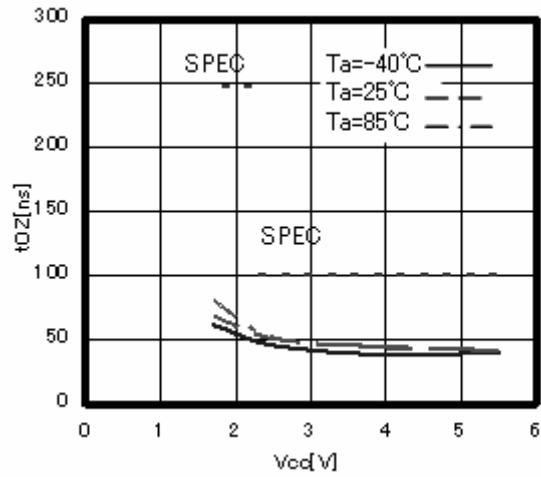

Figure 25. Output disable time tOZ

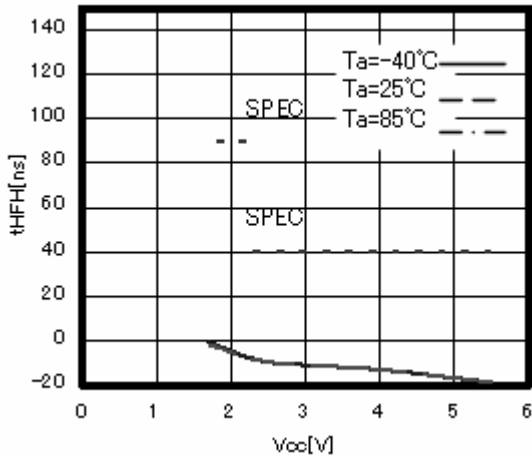

Figure 26.  $\overline{\text{HOLD}}$  setting hold time tHF H

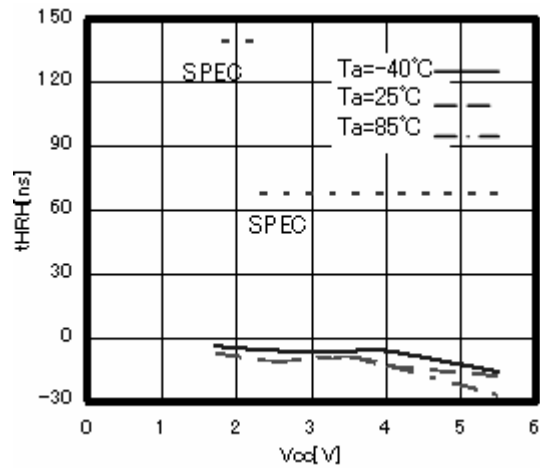

Figure 27.  $\overline{\text{HOLD}}$  release hold time tHRH

● Typical Performance Curves - Continued

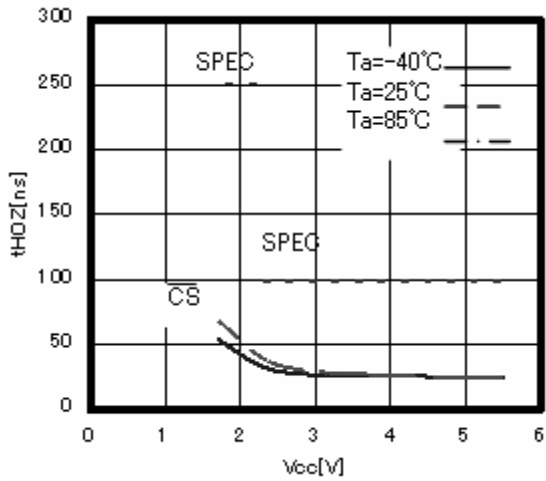

Figure 28. Time From  $\overline{\text{HOLD}}$  to output High-Z tHOZ

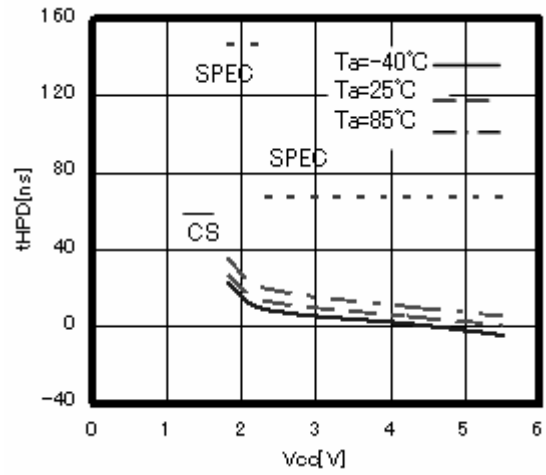

Figure 29. Time from  $\overline{\text{HOLD}}$  to output change tHPD

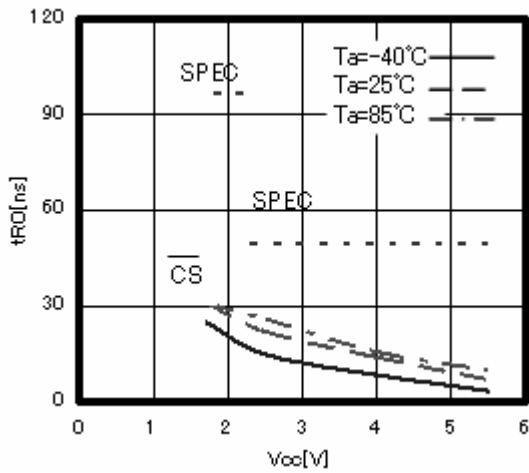

Figure 30. Output rise time tRO

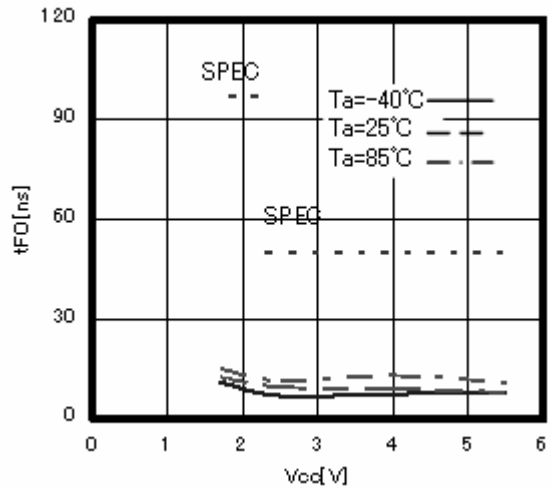

Figure 31. Output fall time tFO

● Typical Performance Curves - Continued

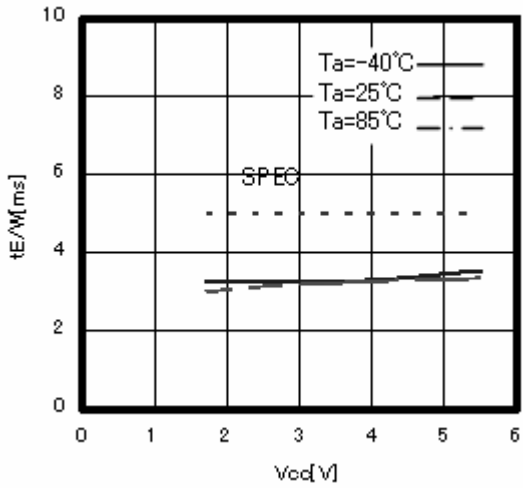

Figure 32. Write cycle time  $t_{E/W}$

## ●Features

### ○Status registers

This IC has status registers. The status registers are of 8 bits and express the following parameters.

BP0 and BP1 can be set by write status register command. These 2 bits are memorized into the EEPROM, therefore are valid even when power source is turned off.

Rewrite characteristics and data hold time are same as characteristics of the EEPROM.

WEN can be set by write enable command and write disable command. WEN becomes write disable status when power source is turned off.  $\overline{R/B}$  is for write confirmation, therefore cannot be set externally.

The value of status register can be read by read status command.

## ●Status registers

| Product number | bit 7 | bit 6 | bit 5 | bit 4 | bit 3 | bit 2 | bit 1 | bit 0            |
|----------------|-------|-------|-------|-------|-------|-------|-------|------------------|
| BU9832GUL-W    | WPEN  | 0     | 0     | 0     | BP1   | BP0   | WEN   | $\overline{R/B}$ |

| bit              | Memory location | Function  | Contents  |
|------------------|-----------------|---|---|
| WPEN             | EEPROM          | $\overline{WP}$ pin enable / disable designation bit<br>WPEN=0=invalid<br>WPEN=1=valid                                | This enables / disables the functions of $\overline{WP}$ pin.   |
| BP1<br>BP0       | EEPROM          | EEPROM write disable block designation bit  | This designates the write disable area of EEPROM. Write designation areas of product numbers are shown below. |
| WEN              | Register        | Write and write status register write enable / disable status confirmation bit<br>WEN=0=prohibited<br>WEN=1=permitted |   |
| $\overline{R/B}$ | Register        | Write cycle status (READY / BUSY) status confirmation bit<br>$\overline{R/B}$ =0=READY<br>$\overline{R/B}$ =1=BUSY    |   |

## ●Write disable block setting

| BP1 | BP0 | Write disable block |
|-----|-----|---------------------|
| 0   | 0   | None                |
| 0   | 1   | 300h-3FFh           |
| 1   | 0   | 200h-3FFh           |
| 1   | 1   | 000h-3FFh           |

### ○ $\overline{WP}$ pin

By setting  $\overline{WP}$  =LOW, write command is prohibited. As for BU9832GUL-W when WPEN bit is set "1", the  $\overline{WP}$  pin functions become valid. And the write command to be disabled at this moment is WRSR.

However, when write cycle is in execution, no interruption can be made.

| Product number | WRSR                                  | WRITE                  |
|----------------|---------------------------------------|------------------------|
| BU9832GUL-W    | Prohibition possible but WPEN bit "1" | Prohibition impossible |

### ○ $\overline{HOLD}$ pin

By  $\overline{HOLD}$  pin, data transfer can be interrupted. When SCK="1", by making  $\overline{HOLD}$  from "1" into "0", data transfer to EEPROM is interrupted. When SCK = "0", by making  $\overline{HOLD}$  from "0" into "1", data transfer is restarted.

●Command mode

| Command |                       | Contents                      | Ope code |      |
|---------|-----------------------|-------------------------------|----------|------|
| WREN    | Write enable          | Write enable command          | 0000     | 0110 |
| WRDI    | Write disable         | Write disable command         | 0000     | 0100 |
| READ    | Read                  | Read command                  | 0000     | 0011 |
| WRITE   | Write                 | Write command                 | 0000     | 0010 |
| RDSR    | Read status register  | Status register read command  | 0000     | 0101 |
| WRSR    | Write status register | Status register write command | 0000     | 0001 |

●Timing chart

1. Write enable (WREN) / disable (WRDI) cycle

- WREN (WRITE ENABLE): Write enable

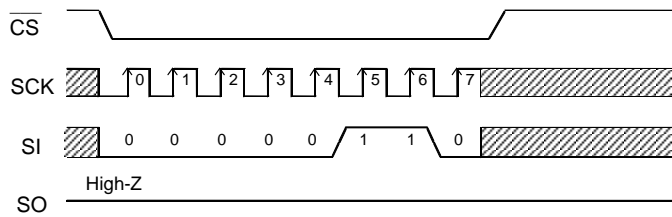

Figure 33. Write enable command

- WRDI (WRITE DISABLE): Write disable

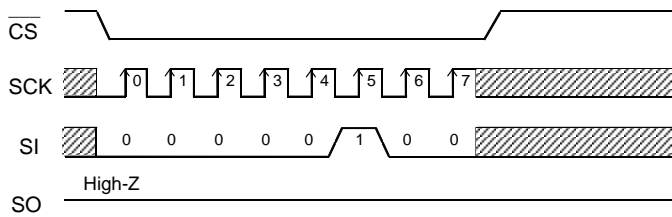

Figure 34. Write disable

○This IC has write enable status and write disable status. It is set to write enable status by write enable command, and it is set to write disable status by write disable command. As for these commands, set CS LOW, and then input the respective op codes. The respective commands accept command at the 7-th clock rise. Even with input over 7 clocks, command becomes valid.

When to carry out write and write status register command, it is necessary to set write enable status by the write enable command. If write or write status register command is input in the write disable status, commands are cancelled. And even in the write enable status, once write and write status register command is executed once, it gets in the write disable status. After power on, this IC is in write disable status.

2. Read command (READ)

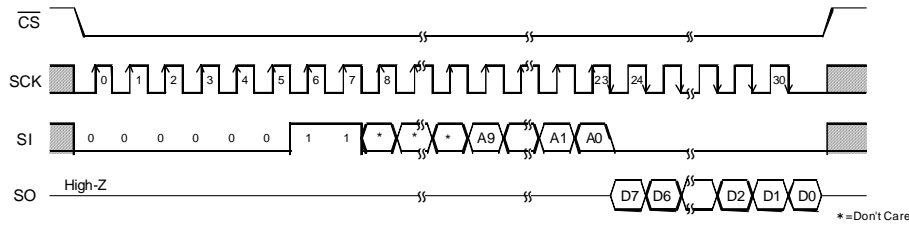

Figure 35. Read command

By read command, data of EEPROM can be read. As for this command, set  $\overline{CS}$  LOW, then input address after read ope code. EEPROM starts data output of the designated address. Data output is started from SCK fall of 15 clock, and from D7 to D0 sequentially. This IC has increment read function. After output of data for 1 byte (8bits), by continuing input of SCK, data of the next address can be read. Increment read can read all the addresses of EEPROM. After reading data of the most significant address, by continuing increment read, data of the most insignificant address is read.

3. Write command (WRITE)

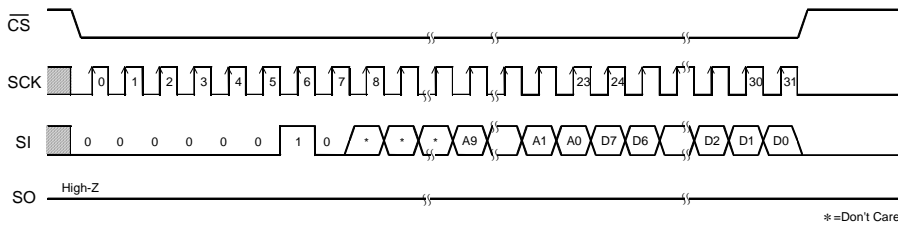

Figure 36. Write command

By write command, data of EEPROM can be written. As for this command, set  $\overline{CS}$  LOW, then input address and data after write ope code. Then, by making  $\overline{CS}$  HIGH, the EEPROM starts writing. The write time of EEPROM requires time of  $t_{E/W}$  (Max 5ms). During  $t_{E/W}$ , other than status read command is not accepted. Start  $\overline{CS}$  after taking the last data (D0), and before the next SCK clock starts. At other timing, write command is not executed, and this write command is cancelled. This IC has page write function, and after input of data for 1 byte (8 bits), by continuing data input without starting  $\overline{CS}$ , data up to 16 bytes can be written for one  $t_{E/W}$ . In page write, the insignificant 4 bit of the designated address is incremented internally at every time when data of 1 byte is input and data is written to respective addresses. When data of the maximum bytes or higher is input, address rolls over, and previously input data is overwritten.



4. Status register write / read command

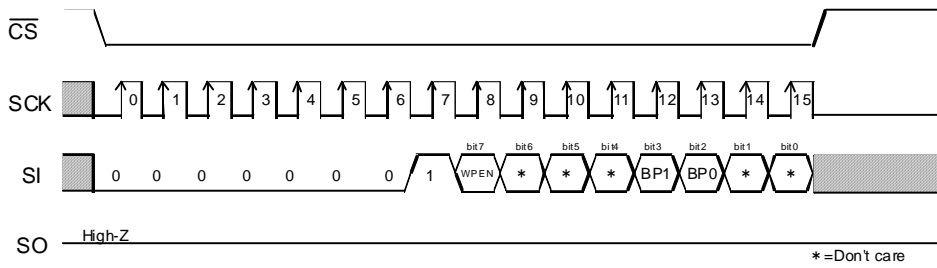

Figure 37. Status register write command

Write status register command can write status register data. The data can be written by this command are 2 bits<sup>\*1</sup>, that is, BP1 (bit3) and BP0 (bit2) among 8 bits of status register. By BP1 and BP0, write disable block of EEPROM can be set. As for this command, set  $\overline{CS}$  LOW, and input ope code of write status register, and input data. Then, by making  $\overline{CS}$  HIGH, EEPROM starts writing. Write time requires time of tE/W as same as write. As for  $\overline{CS}$  rise, start  $\overline{CS}$  after taking the last data bit (bit0), and before the next SCK clock starts. At other timing, command is cancelled. Write disable block is determined by BP1 and BP0, and the block can be selected from 1/4 of memory array, 1/2, and entire memory array. (Refer to the write disable block setting table.) To the write disabled block, write cannot be made, and only read can be made.

\*1 3bits including 1WPEN (bit7)

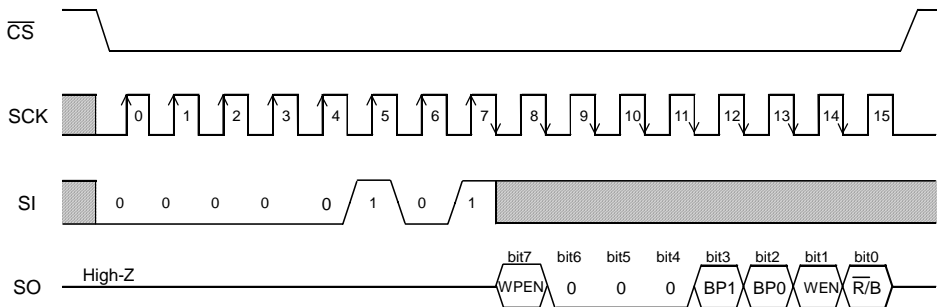

Figure 38. Status register read command

● **At standby**

○ **Current at standby**

Set  $\overline{CS}$  "H", and be sure to set SCK, SI,  $\overline{WP}$ ,  $\overline{HOLD}$  input "L" or "H". Do not input intermediate electric potential.

○ **Timing**

As shown in Figure 39, at standby, when SCK is "H", even if  $\overline{CS}$  is fallen, SI status is not read at fall edge. SI status is read at SCK rise edge after fall of  $\overline{CS}$ . At standby and at power ON/OFF, set  $\overline{CS}$  "H" status.

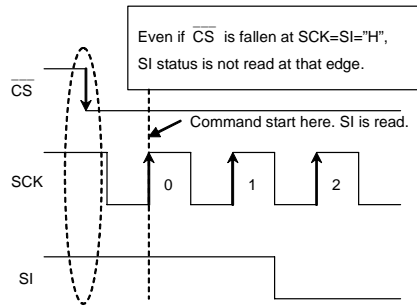

Figure 39. Operating timing

●  **$\overline{WP}$  cancel valid area**

$\overline{WP}$  is normally fixed to "H" or "L" for use, but when  $\overline{WP}$  is controlled so as to cancel write status register command and write command, pay attention to the following  $\overline{WP}$  valid timing.

While write or write status register command is executed, by setting  $\overline{WP}$  = "L" in cancel valid area, command can be cancelled. The area from command ope code before  $\overline{CS}$  rise at internal automatic write start becomes the cancel valid area. However, once write is started, any input cannot be cancelled.  $\overline{WP}$  input becomes Don't Care, and cancellation becomes invalid.

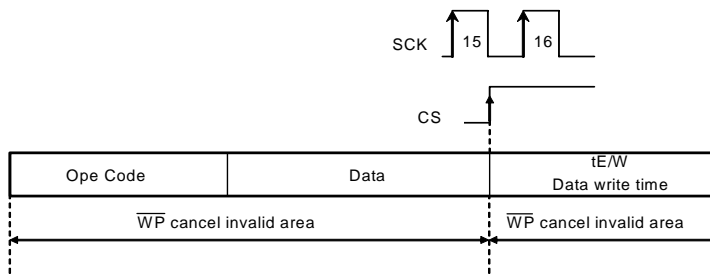

Figure 40.  $\overline{WP}$  valid timing (WRSR)

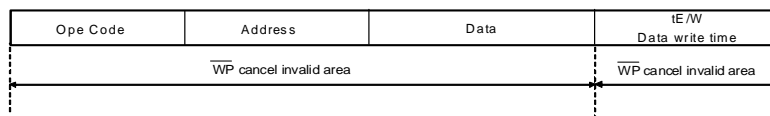

Figure 41.  $\overline{WP}$  valid timing (WRITE)

● **HOLD pin**

By HOLD pin, command communication can be stopped temporarily (HOLD status). The  $\overline{HOLD}$  pin carries out command communications normally when it is HIGH. To get in HOLD status, at command communication, when SCK=LOW, set the  $\overline{HOLD}$  pin LOW. At HOLD status, SCK and SI become Don't Care, and SO becomes high impedance (High-Z). To release the HOLD status, set the  $\overline{HOLD}$  pin HIGH when SCK=LOW. After that, communication can be restarted from the point before the HOLD status. For example, when HOLD status is made after A5 address input at read, after release of  $\overline{HOLD}$  status, by starting A4 address input, read can be restarted. When in HOLD status, leave  $\overline{CS}$  LOW. When it is set  $\overline{CS}$ =HIGH in HOLD status, the IC is reset, therefore communication after that cannot be restarted.

●Method to cancel each command

OREAD

- Method to cancel : cancel by  $\overline{CS} = "H"$

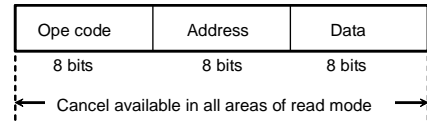

Figure 42. READ cancel valid timing

ORDSR

- Method to cancel : cancel by  $\overline{CS} = "H"$

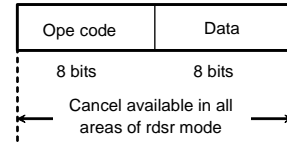

Figure 43. RDSR cancel valid timing

OWRITE, PAGE WRITE

- a: Ope code, address input area.

Cancellation is available by  $\overline{CS} = "H"$

- b: Data input area (D7 to D1 input area)

Cancellation is available by  $\overline{CS} = "H"$

- c: Data input area (D0 area)

When  $\overline{CS}$  is started, write starts.

After  $\overline{CS}$  rise, cancellation cannot be made by any means.

- d: tE/W area.

Cancellation is available by  $\overline{CS} = "H"$ . However, when write starts ( $\overline{CS}$  is started) in the area c, cancellation cannot be made by any means. And by inputting on SCK clock, cancellation cannot be made. In page write mode, there is write enable area at every 8 clocks.

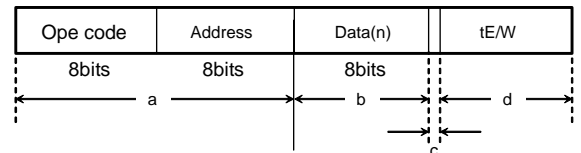
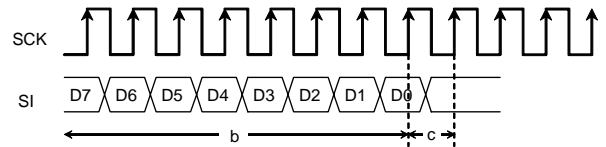

Figure 44. WRITE cancel valid timing



Note 1) If  $V_{cc}$  is made OFF during write execution, designated address data is not guaranteed, therefore write it once again.

Note 2) If  $\overline{CS}$  is started at the same timing as that of the SCK rise, write execution / cancel becomes unstable, therefore, it is necessary to fall in SCK = "L" area. As for SCK rise, assure timing of tCSS / tCSH or higher.

OWRSR

- a: From ope code to 15 rise.

Cancel by  $\overline{CS} = "H"$ .

- b: From 15 clock rise to 16 clock rise (write enable area).

When  $\overline{CS}$  is started, write starts.

After  $\overline{CS}$  rise, cancellation cannot be made by any means.

- c: After 16 clock rise.

Cancel by  $\overline{CS} = "H"$ . However, when write starts ( $\overline{CS}$  is started) in the area b, cancellation cannot be made by any means.

And, by inputting on SCK clock, cancellation cannot be made.

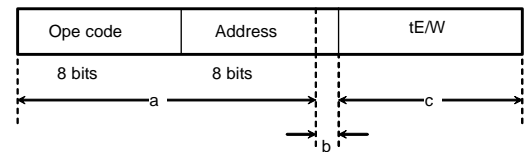
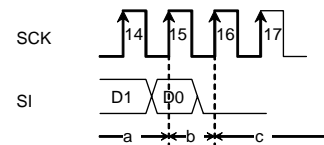

Figure 45. WRSR cancel valid timing

Note 1) If  $V_{cc}$  is made OFF during write execution, designated address data is not guaranteed, therefore write it once again

Note 2) If  $\overline{CS}$  is started at the same timing as that of the SCK rise, write execution / cancel becomes unstable, therefore, it is necessary to fall in SCK = "L" area. As for SCK rise, assure timing of tCSS / tCSH or higher.

OWREN/WRDI

- a: From ope code to clock rise, cancel by  $\overline{CS} = "H"$ .

- b: Cancellation is not available when  $\overline{CS}$  is started after 7 clock.

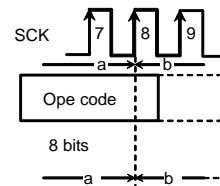

Figure 46. WREN/WRDI cancel valid timing

●High speed operation

In order to realize stable high speed operations, pay attention to the following input / output pin conditions.

○Input pin pull up, pull down resistance

When to attach pull up, pull down resistance to EEPROM input pin, select an appropriate value for the microcontroller  $V_{OL}$ ,  $I_{OL}$  from  $V_{IL}$  characteristics of this IC.

○Pull up resistance

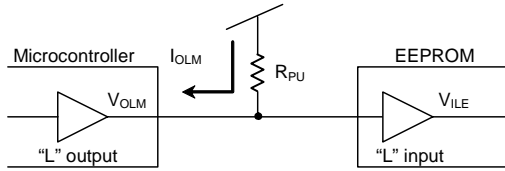

Figure 47. Pull up resistance

$$R_{PU} \geq \frac{V_{CC} - V_{OLM}}{I_{OLM}} \quad \dots \textcircled{1}$$

$$V_{OLM} \leq V_{ILE} \quad \dots \textcircled{2}$$

Example) When  $V_{CC}=5V$ ,  $V_{ILM}=1.5V$ ,  $V_{OLM}=0.4V$ ,  $I_{OLM}=2mA$ , from the equation ①,

$$R_{PU} \geq \frac{5 - 0.4}{2 \times 10^{-3}}$$

$$\therefore R_{PU} \geq 2.3[\Omega]$$

With the value of  $R_{PU}$  to satisfy the above equation,  $V_{OLM}$  becomes 0.4V or higher, and with  $V_{ILE}$  (=1.5V), the equation ② is also satisfied.

- $V_{ILM}$  : EEPROM  $V_{IH}$  specifications
- $V_{OLM}$  : Microcontroller  $V_{OL}$  specifications
- $I_{OLM}$  : Microcontroller  $I_{OL}$  specifications

And, in order to prevent malfunction, mistake write at power ON/OFF, be sure to make  $\overline{CS}$  pull up.

○Pull down resistance

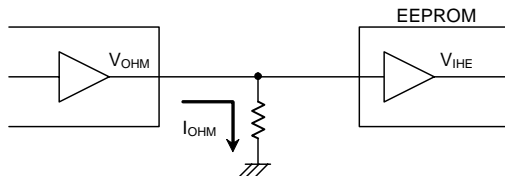

Figure 48. Pull down resistance

$$R_{PD} \geq \frac{V_{OHM}}{I_{OHM}} \quad \dots \textcircled{3}$$

$$V_{OHM} \geq V_{IHE} \quad \dots \textcircled{4}$$

Example) When  $V_{CC}=5V$ ,  $V_{OHM}=V_{CC}-0.5V$ ,  $I_{OHM}=0.4mA$ ,  $V_{IHM}=V_{CC} \times 0.7V$ , from the equation ③,

$$R_{PD} \geq \frac{5 - 0.5}{0.4 \times 10^{-3}}$$

$$\therefore R_{PD} \geq 11.3[k\Omega]$$

Further, by amplitude  $V_{IHE}$ ,  $V_{ILE}$  of signal input to EEPROM, operation speed changes. By inputting signal of amplitude of  $V_{CC}$  / GND level to input, more stable high speed operations can be realized. On the contrary, when amplitude of  $0.8V_{CC}$  /  $0.2V_{CC}$  is input, operation speed becomes slow. <sup>\*1</sup>

In order to realize more stable high speed operation, it is recommended to make the values of  $R_{PU}$ ,  $R_{PD}$  as large as possible, and make the amplitude of signal input to EEPROM close to the amplitude of  $V_{CC}$  / GND level.

(\*1 At this moment, operating timing guaranteed value is guaranteed.)

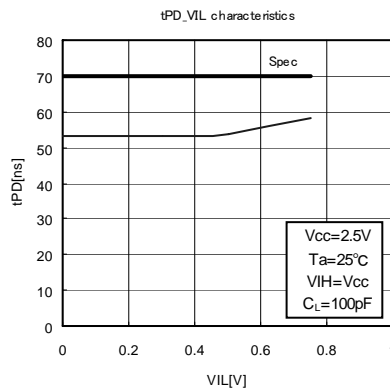

Figure 49.  $V_{IL}$  dependency of data output delay time

○SO load capacity condition

Load capacity of SO output pin affects upon delay characteristic of SO output. (Data output delay time, time from  $\overline{\text{HOLD}}$  to High-Z) In order to make output delay characteristic into higher speed, make SO load capacity small. In concrete, “Do not connect many devices to SO bus”, “Make the wire between the controller and EEPROM short”, and so forth.

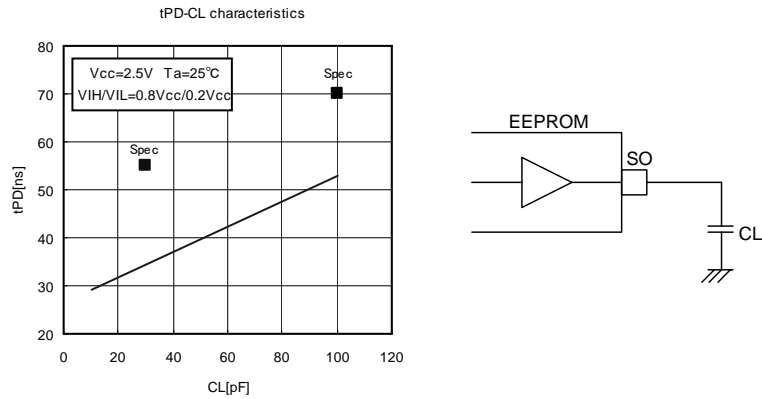

Figure 50. SO load dependency of data output delay time

○Other cautions

Make the wire length from the microcontroller to EEPROM input signal same length, in order to prevent setup / hold violation to EEPROM, owing to difference of wire length of each input.

●Equivalent circuit

○Output circuit

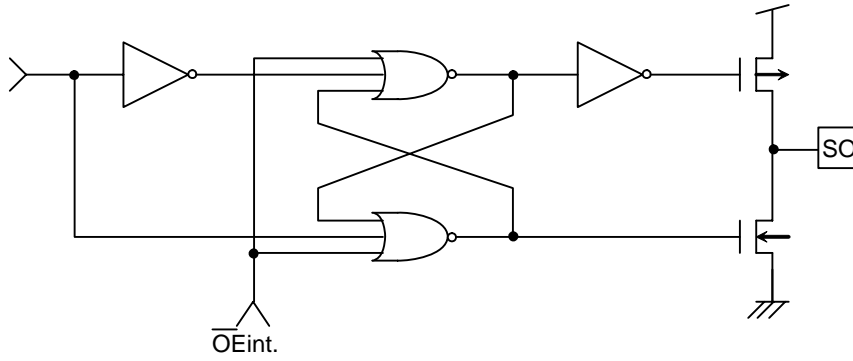

Figure 51. SO output equivalent circuit

○Input circuit

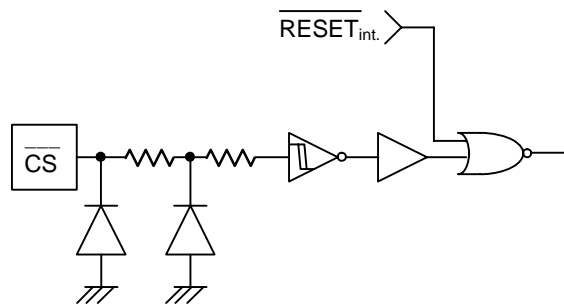

Figure 52.  $\overline{CS}$  input equivalent circuit

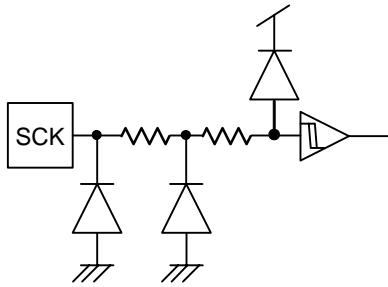

Figure 53. SCK input equivalent circuit

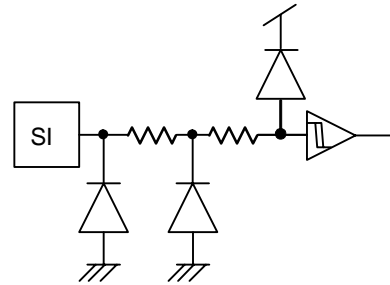

Figure 54. SI input equivalent circuit

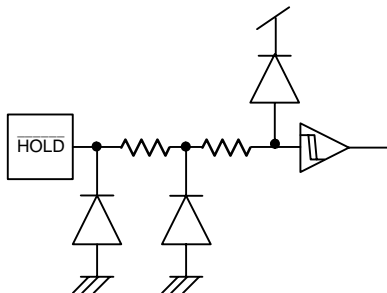

Figure 55.  $\overline{HOLD}$  input equivalent circuit

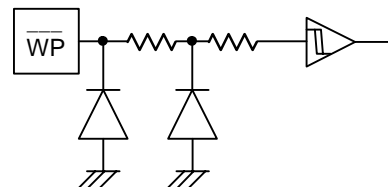

Figure 56.  $\overline{WP}$  input equivalent circuit

### ●Notes on power ON/OFF

○At power ON/OFF, set  $\overline{CS}$  "H" (=Vcc).

When  $\overline{CS}$  is "L", this IC gets in input accept status (active). If power is turned on in this status, noises and the likes may cause malfunction, mistake write or so. To prevent these, at power ON, set  $\overline{CS}$  "H". (When  $\overline{CS}$  is in "H" status, all inputs are canceled.)

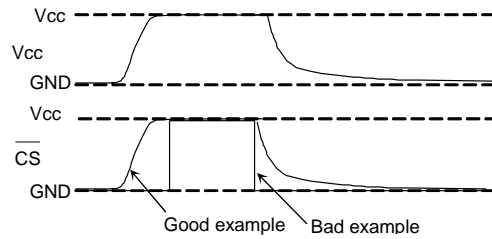

Figure 57.  $\overline{CS}$  timing at power ON/OFF

(Good example)  $\overline{CS}$  terminal is pulled up to Vcc.

At power OFF, take 10ms or higher before supply. If power is turned on without observing this condition, the IC internal circuit may not be reset, which please note.

(Bad example)  $\overline{CS}$  terminal is "L" at power ON/OFF.

In this case,  $\overline{CS}$  always becomes "L" (active status), and EEPROM may have malfunction, mistake write owing to noises and the likes.

Even when  $\overline{CS}$  input is High-Z, the status becomes like this case, which please note.

### OP.O.R. circuit

This IC has a P.O.R. (Power On Reset) circuit as mistake write countermeasure. After P.O.R. action, it gets in write disable status. The P.O.R. circuit is valid only when power is ON, and does not work when power is OFF. When power is ON, if the recommended conditions of the following  $t_R$ ,  $t_{OFF}$ , and  $V_{bot}$  are not satisfied, it may become write enable status owing to noises and the likes.

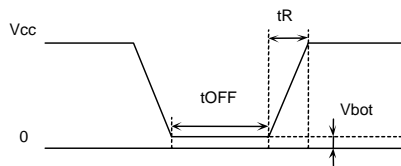

Figure 58. Rise waveform

Recommended conditions of  $t_R$ ,  $t_{OFF}$ ,  $V_{bot}$

| $t_R$          | $t_{OFF}$      | $V_{bot}$     |
|----------------|----------------|---------------|
| 10ms or below  | 10ms or higher | 0.3V or below |
| 100ms or below | 10ms or higher | 0.2V or below |

### ●Noise countermeasures

○Vcc noise (bypass capacitor)

When noise or surge gets in the power source line, malfunction may occur, therefore, for removing these, it is recommended to attach a bypass capacitor (0.1 $\mu$ F) between IC Vcc and GND. At that moment, attach it as close to IC as possible. And, it is also recommended to attach a bypass capacitor between board Vcc and GND.

○SCK noise

When the rise time ( $t_R$ ) of SCK is long, and a certain degree or more of noise exists, malfunction may occur owing to clock bit displacement. To avoid this, a Schmitt trigger circuit is built in SCK input. The hysteresis width of this circuit is set about 0.2V, if noises exist at SCK input, set the noise amplitude 0.2Vp-p or below. And it is recommended to set the rise time ( $t_R$ ) of SCK 100ns or below. In the case when the rise time is 100ns or higher, take sufficient noise countermeasures. Make the clock rise, fall time as small as possible.

○ $\overline{WP}$  noise

During execution of write status register command, if there exist noises on  $\overline{WP}$  pin, mistake in recognition may occur and forcible cancellation may result, which please note. To avoid this, a Schmitt trigger circuit is built in  $\overline{WP}$  input. In the same manner, a Schmitt trigger circuit is built in CS input, SI input and HOLD input too.

**●Notes for use**

- (1) Described numeric values and data are design representative values, and the values are not guaranteed.
- (2) We believe that application circuit examples are recommendable, however, in actual use, confirm characteristics further sufficiently. In the case of use by changing the fixed number of external parts, make your decision with sufficient margin in consideration of static characteristics and transition characteristics and fluctuations of external parts and our LSI.
- (3) Absolute maximum ratings  
If the absolute maximum ratings such as impressed voltage and operating temperature range and so forth are exceeded, LSI may be destructed. Do not impress voltage and temperature exceeding the absolute maximum ratings. In the case of fear exceeding the absolute maximum ratings, take physical safety countermeasures such as fuses, and see to it that conditions exceeding the absolute maximum ratings should not be impressed to LSI.
- (4) GND electric potential  
Set the voltage of GND terminal lowest at any action condition. Make sure that each terminal voltage is higher than that of GND terminal.
- (5) Heat design  
In consideration of permissible dissipation in actual use condition, carry out heat design with sufficient margin.
- (6) Terminal to terminal short circuit and wrong packaging  
When to package LSI onto a board, pay sufficient attention to LSI direction and displacement. Wrong packaging may destruct LSI. And in the case of short circuit between LSI terminals and terminals and power source, terminal and GND owing to foreign matter, LSI may be destructed.
- (7) Use in a strong electromagnetic field may cause malfunction, therefore, evaluate design sufficiently.

**Status of this document**

The Japanese version of this document is formal specification. A customer may use this translation version only for a reference to help reading the formal version.

If there are any differences in translation version of this document formal version takes priority.



●Ordering Information

B U 9 8 3 2 G U L - W

E 2

Part Number

Package  
GUL: VCSP50L2(BU9832GUL-W)

Packaging and forming specification  
E2: Embossed tape and reel

●Physical Dimension Tape and Reel Information

VCSP50L2 (BU9832GUL-W)

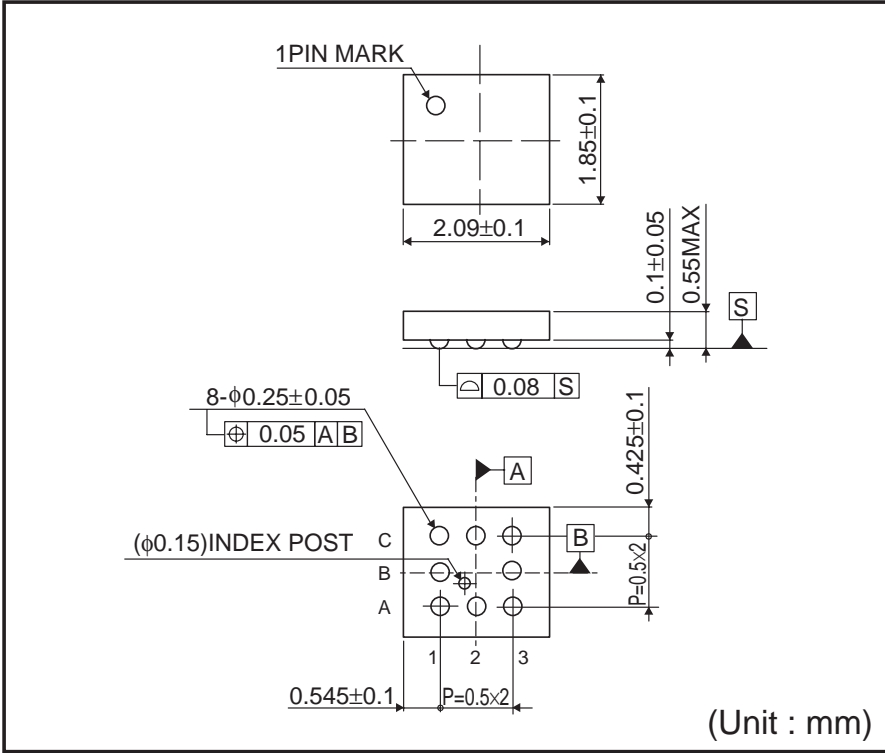

<Tape and Reel information>

|                   |   |
|-------------------|---|
| Tape              | Embossed carrier tape   |
| Quantity          | 3000pcs   |
| Direction of feed | E2<br>( The direction is the 1pin of product is at the upper left when you hold reel on the left hand and you pull out the tape on the right hand ) |

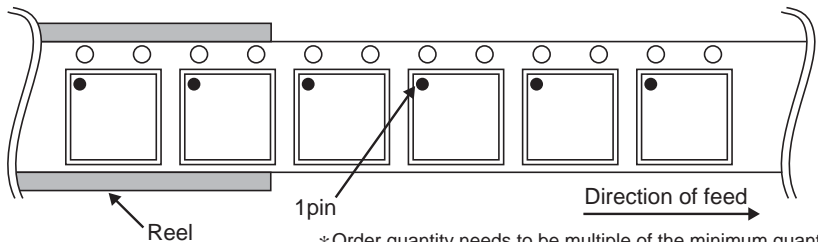

●Marking Diagram

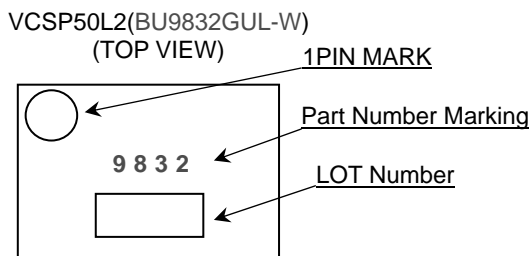

●Revision History

| Date        | Revision | Changes     |
|-------------|----------|-------------|
| 30.Aug.2012 | 001      | New Release |

# Notice

## ●General Precaution

- 1) Before you use our Products, you are requested to carefully read this document and fully understand its contents. ROHM shall not be in any way responsible or liable for failure, malfunction or accident arising from the use of any ROHM's Products against warning, caution or note contained in this document.
- 2) All information contained in this document is current as of the issuing date and subject to change without any prior notice. Before purchasing or using ROHM's Products, please confirm the latest information with a ROHM sales representative.

## ●Precaution on using ROHM Products

- 1) Our Products are designed and manufactured for application in ordinary electronic equipments (such as AV equipment, OA equipment, telecommunication equipment, home electronic appliances, amusement equipment, etc.). If you intend to use our Products in devices requiring extremely high reliability (such as medical equipment, transport equipment, traffic equipment, aircraft/spacecraft, nuclear power controllers, fuel controllers, car equipment including car accessories, safety devices, etc.) and whose malfunction or failure may cause loss of human life, bodily injury or serious damage to property ("Specific Applications"), please consult with the ROHM sales representative in advance. Unless otherwise agreed in writing by ROHM in advance, ROHM shall not be in any way responsible or liable for any damages, expenses or losses incurred by you or third parties arising from the use of any ROHM's Products for Specific Applications.
- 2) ROHM designs and manufactures its Products subject to strict quality control system. However, semiconductor products can fail or malfunction at a certain rate. Please be sure to implement, at your own responsibilities, adequate safety measures including but not limited to fail-safe design against the physical injury, damage to any property, which a failure or malfunction of our Products may cause. The following are examples of safety measures:
  - [a] Installation of protection circuits or other protective devices to improve system safety
  - [b] Installation of redundant circuits to reduce the impact of single or multiple circuit failure
- 3) Our Products are designed and manufactured for use under standard conditions and not under any special or extraordinary environments or conditions, as exemplified below. Accordingly, ROHM shall not be in any way responsible or liable for any damages, expenses or losses arising from the use of any ROHM's Products under any special or extraordinary environments or conditions. If you intend to use our Products under any special or extraordinary environments or conditions (as exemplified below), your independent verification and confirmation of product performance, reliability, etc. prior to use, must be necessary:
  - [a] Use of our Products in any types of liquid, including water, oils, chemicals, and organic solvents
  - [b] Use of our Products outdoors or in places where the Products are exposed to direct sunlight or dust
  - [c] Use of our Products in places where the Products are exposed to sea wind or corrosive gases, including Cl<sub>2</sub>, H<sub>2</sub>S, NH<sub>3</sub>, SO<sub>2</sub>, and NO<sub>2</sub>
  - [d] Use of our Products in places where the Products are exposed to static electricity or electromagnetic waves
  - [e] Use of our Products in proximity to heat-producing components, plastic cords, or other flammable items
  - [f] Sealing or coating our Products with resin or other coating materials
  - [g] Use of our Products without cleaning residue of flux (even if you use no-clean type fluxes, cleaning residue of flux is recommended); or Washing our Products by using water or water-soluble cleaning agents for cleaning residue after soldering
  - [h] Use of the Products in places subject to dew condensation
- 4) The Products are not subject to radiation-proof design.
- 5) Please verify and confirm characteristics of the final or mounted products in using the Products.
- 6) In particular, if a transient load (a large amount of load applied in a short period of time, such as pulse) is applied, confirmation of performance characteristics after on-board mounting is strongly recommended. Avoid applying power exceeding normal rated power; exceeding the power rating under steady-state loading condition may negatively affect product performance and reliability.
- 7) De-rate Power Dissipation (Pd) depending on Ambient temperature (Ta). When used in sealed area, confirm the actual ambient temperature.
- 8) Confirm that operation temperature is within the specified range described in the product specification.
- 9) ROHM shall not be in any way responsible or liable for failure induced under deviant condition from what is defined in this document.

**●Precaution for Mounting / Circuit board design**

- 1) When a highly active halogenous (chlorine, bromine, etc.) flux is used, the residue of flux may negatively affect product performance and reliability.
- 2) In principle, the reflow soldering method must be used; if flow soldering method is preferred, please consult with the ROHM representative in advance.

For details, please refer to ROHM Mounting specification

**●Precautions Regarding Application Examples and External Circuits**

- 1) If change is made to the constant of an external circuit, please allow a sufficient margin considering variations of the characteristics of the Products and external components, including transient characteristics, as well as static characteristics.
- 2) You agree that application notes, reference designs, and associated data and information contained in this document are presented only as guidance for Products use. Therefore, in case you use such information, you are solely responsible for it and you must exercise your own independent verification and judgment in the use of such information contained in this document. ROHM shall not be in any way responsible or liable for any damages, expenses or losses incurred by you or third parties arising from the use of such information.

**●Precaution for Electrostatic**

This Product is electrostatic sensitive product, which may be damaged due to electrostatic discharge. Please take proper caution in your manufacturing process and storage so that voltage exceeding the Products maximum rating will not be applied to Products. Please take special care under dry condition (e.g. Grounding of human body / equipment / solder iron, isolation from charged objects, setting of Ionizer, friction prevention and temperature / humidity control).

**●Precaution for Storage / Transportation**

- 1) Product performance and soldered connections may deteriorate if the Products are stored in the places where:
  - [a] the Products are exposed to sea winds or corrosive gases, including Cl<sub>2</sub>, H<sub>2</sub>S, NH<sub>3</sub>, SO<sub>2</sub>, and NO<sub>2</sub>
  - [b] the temperature or humidity exceeds those recommended by ROHM
  - [c] the Products are exposed to direct sunshine or condensation
  - [d] the Products are exposed to high Electrostatic
- 2) Even under ROHM recommended storage condition, solderability of products out of recommended storage time period may be degraded. It is strongly recommended to confirm solderability before using Products of which storage time is exceeding the recommended storage time period.
- 3) Store / transport cartons in the correct direction, which is indicated on a carton with a symbol. Otherwise bent leads may occur due to excessive stress applied when dropping of a carton.
- 4) Use Products within the specified time after opening a humidity barrier bag. Baking is required before using Products of which storage time is exceeding the recommended storage time period.

**●Precaution for Product Label**

QR code printed on ROHM Products label is for ROHM's internal use only.

**●Precaution for Disposition**

When disposing Products please dispose them properly using an authorized industry waste company.

**●Precaution for Foreign Exchange and Foreign Trade act**

Since our Products might fall under controlled goods prescribed by the applicable foreign exchange and foreign trade act, please consult with ROHM representative in case of export.

**●Precaution Regarding Intellectual Property Rights**

- 1) All information and data including but not limited to application example contained in this document is for reference only. ROHM does not warrant that foregoing information or data will not infringe any intellectual property rights or any other rights of any third party regarding such information or data. ROHM shall not be in any way responsible or liable for infringement of any intellectual property rights or other damages arising from use of such information or data.:
- 2) No license, expressly or implied, is granted hereby under any intellectual property rights or other rights of ROHM or any third parties with respect to the information contained in this document.

●Other Precaution

- 1) The information contained in this document is provided on an "as is" basis and ROHM does not warrant that all information contained in this document is accurate and/or error-free. ROHM shall not be in any way responsible or liable for any damages, expenses or losses incurred by you or third parties resulting from inaccuracy or errors of or concerning such information.
- 2) This document may not be reprinted or reproduced, in whole or in part, without prior written consent of ROHM.
- 3) The Products may not be disassembled, converted, modified, reproduced or otherwise changed without prior written consent of ROHM.
- 4) In no event shall you use in any way whatsoever the Products and the related technical information contained in the Products or this document for any military purposes, including but not limited to, the development of mass-destruction weapons.
- 5) The proper names of companies or products described in this document are trademarks or registered trademarks of ROHM, its affiliated companies or third parties.

Компания «Океан Электроники» предлагает заключение долгосрочных отношений при поставках импортных электронных компонентов на взаимовыгодных условиях!

Наши преимущества:

- Поставка оригинальных импортных электронных компонентов напрямую с производств Америки, Европы и Азии, а так же с крупнейших складов мира;
- Широкая линейка поставок активных и пассивных импортных электронных компонентов (более 30 млн. наименований);
- Поставка сложных, дефицитных, либо снятых с производства позиций;
- Оперативные сроки поставки под заказ (от 5 рабочих дней);
- Экспресс доставка в любую точку России;
- Помощь Конструкторского Отдела и консультации квалифицированных инженеров;
- Техническая поддержка проекта, помощь в подборе аналогов, поставка прототипов;
- Поставка электронных компонентов под контролем ВП;
- Система менеджмента качества сертифицирована по Международному стандарту ISO 9001;
- При необходимости вся продукция военного и аэрокосмического назначения проходит испытания и сертификацию в лаборатории (по согласованию с заказчиком);
- Поставка специализированных компонентов военного и аэрокосмического уровня качества (Xilinx, Altera, Analog Devices, Intersil, Interpoint, Microsemi, Actel, Aeroflex, Peregrine, VPT, Syfer, Eurofarad, Texas Instruments, MS Kennedy, Miteq, Cobham, E2V, MA-COM, Hittite, Mini-Circuits, General Dynamics и др.);

Компания «Океан Электроники» является официальным дистрибьютором и эксклюзивным представителем в России одного из крупнейших производителей разъемов военного и аэрокосмического назначения «JONHON», а так же официальным дистрибьютором и эксклюзивным представителем в России производителя высокотехнологичных и надежных решений для передачи СВЧ сигналов «FORSTAR».



## JONHON

«JONHON» (основан в 1970 г.)

Разъемы специального, военного и аэрокосмического назначения:

(Применяются в военной, авиационной, аэрокосмической, морской, железнодорожной, горно- и нефтедобывающей отраслях промышленности)

«FORSTAR» (основан в 1998 г.)

ВЧ соединители, коаксиальные кабели, кабельные сборки и микроволновые компоненты:

(Применяются в телекоммуникациях гражданского и специального назначения, в средствах связи, РЛС, а так же военной, авиационной и аэрокосмической отраслях промышленности).



Телефон: 8 (812) 309-75-97 (многоканальный)

Факс: 8 (812) 320-03-32

Электронная почта: [ocean@oceanchips.ru](mailto:ocean@oceanchips.ru)

Web: <http://oceanchips.ru/>

Адрес: 198099, г. Санкт-Петербург, ул. Калинина, д. 2, корп. 4, лит. А