



Description

The IMX7/IMS7 Series of board-mountable 7 Watt DC-DC converters have been designed according to the latest industry requirements and standards. The converters are particularly suitable for use in mobile or stationary applications in transport, railways, industry, or telecom, where variable input voltages or high transient voltages are prevalent.

Covering a total input voltage range from 8.4 V to 150 V with six different models, the converters are available with single and electrically-isolated double outputs from 3.3 up to 48 V with flexible load distribution on double outputs. A shutdown input allows remote on/off.

Features include efficient input and output filtering with good transient and surge protection, low output ripple and noise, consistently high efficiency over the entire input voltage range, and high reliability as well as excellent dynamic response to load and line changes.

The converters provide supplementary insulation with SELV outputs as for instances required in battery-supported systems, where the bus voltage may exceed the SELV limit of 60 V. The models 70IMX7 and 110IMX7 are CE-marked.

Features

- RoHS lead-free-solder and lead-solder-exempted products are available.
- Input voltage ranges up to 150 VDC
- 1 or 2 isolated outputs up to 48 V
- 1500 to 2000 VAC voltage withstand test
- Extremely wide input voltage ranges
- Immunity according to IEC/EN 61000-4-2, -3, -4, -5, -6
- High efficiency (typ. 84%)
- Input undervoltage lockout
- Inhibit input, adjustable output voltages
- Flex power: flexible load distribution on outputs
- Outputs no-load, overload, and short-circuit proof
- High reliability and no derating
- Operating ambient temperature –40 to +85 °C
- Thermal protection
- Supplementary insulation
- Planar technology for best mechanical stability
- 2" x 1" case with 10.5 mm profile

Safety-approved to IEC 60950-1 and UL/CSA 60950-1 2nd Ed.



1 70/110IMX7 models

The circuitry is comprised of integral planar magnetics. All components are automatically assembled and securely soldered onto a single PCB without any wire connections. Magnetic feedback ensures maximum reliability and repeatability in the control loop over all operating conditions. Careful considerations of possible thermal stresses ensure the absence of hot spots, providing long life in environments, where temperature cycles are a reality. The thermal design allows operation at full load up to an ambient temperature of 85 °C in free air without using any potting material. For extremely high vibration environments the case has holes for screw mounting.

Several options, such as open-frame, provide a high level of application-specific engineering and design-in flexibility.

Table of Contents

	Page		Page
Description	1	Electromagnetic Compatibility (EMC)	11
Model Selection	2	Immunity to Environmental Conditions	12
Functional Description	3	Mechanical Data	13
Electrical Input Data	4	Safety and Installation Instructions	13
Electrical Output Data	7	Description of Options	14
Auxiliary Functions	9		

Copyright © 2015, Bel Power Solutions Inc. All rights reserved.

Model Selection

Table 1: Model Selection

Output 1		Output 2 ¹		Output power $P_{o \text{ nom}}$ [W]	Input voltage range [V]	Efficiency		Model	Options
$V_{o1 \text{ nom}}$ [V]	$I_{o1 \text{ nom}}$ [A]	$V_{o2 \text{ nom}}$ [V]	$I_{o2 \text{ nom}}$ [A] ¹			η_{min} [%]	η_{typ} [%]		
3.3	1.5	-	-	5	8.4 – 36	74	78	20IMX7-03-8	Z, G
3.3	1.5	-	-	5	14 – 36	75.5	79	24IMS7-03-9	Z, G
3.3	1.5	-	-	5	16.8 ² – 75	74.7	79	40IMX7-03-8	Z, G
3.3	1.5	-	-	5	36 – 75	77	79	48IMS7-03-9	Z, G
3.3	1.5	-	-	5	40 – 121	76	78	70IMX7-03-8	Z, G
3.3	1.5	-	-	5	60 – 150 ²	74.5	78	110IMX7-03-8	Z, G
5.1	1.2	-	-	6.1	8.4 – 36	75.5	78	20IMX7-05-8	M, Z, G
5.1	1.2	-	-	6.1	14 – 36	77	80	24IMS7-05-9	Z, G
5.1	1.2	-	-	6.1	16.8 ² – 75	79	81	40IMX7-05-8	M, Z, G
5.1	1.2	-	-	6.1	36 – 75	78	81	48IMS7-05-9	Z, G
5.1	1.2	-	-	6.1	40 – 121	75.5	78	70IMX7-05-8	M, Z, G
5.1	1.2	-	-	6.1	60 – 150 ³	76	79	110IMX7-05-8	M, Z, G
5	0.6	5	0.6	6	8.4 – 36	77	81	20IMX7-05-05-8	M, Z, G
5	0.7	5	0.7	7	14 – 36	79	82	24IMS7-05-05-9	Z, G
5	0.7	5	0.7	7	16.8 ² – 75	79.5	82	40IMX7-05-05-8	M, Z, G
5	0.7	5	0.7	7	36 – 75	81.5	83	48IMS7-05-05-9	Z, G
5	0.7	5	0.7	7	40 – 121	81	82	70IMX7-05-05-8	M, Z, G
5	0.7	5	0.7	7	60 – 150 ³	78	80	110IMX7-05-05-8	M, Z, G
12	0.25	12	0.25	6	8.4 – 36	80.5	83	20IMX7-12-12-8	M, Z, G
12	0.3	12	0.3	7.2	14 – 36	81.5	85	24IMS7-12-12-9	Z, G
12	0.3	12	0.3	7.2	16.8 ² – 75	82.5	84	40IMX7-12-12-8	M, Z, G
12	0.3	12	0.3	7.2	36 – 75	82	84	48IMS7-12-12-9	Z, G
12	0.3	12	0.3	7.2	40 – 121	83	85	70IMX7-12-12-8	M, Z, G
12	0.3	12	0.3	7.2	60 – 150 ³	80	83	110IMX7-12-12-8	M, Z, G
15	0.2	15	0.2	6	8.4 – 36	81	83	20IMX7-15-15-8	M, Z, G
15	0.24	15	0.24	7.2	14 – 36	81.5	84	24IMS7-15-15-9	Z, G
15	0.24	15	0.24	7.2	16.8 ² – 75	81	84	40IMX7-15-15-8	M, Z, G
15	0.24	15	0.24	7.2	36 – 75	82	84	48IMS7-15-15-9	Z, G
15	0.24	15	0.24	7.2	40 – 121	81.5	83	70IMX7-15-15-8	M, Z, G
15	0.24	15	0.24	7.2	60 – 150 ³	79	82	110IMX7-15-15-8	M, Z, G
24	0.13	24	0.13	6.2	8.4 – 36	79	83	20IMX7-24-24-8	M, Z, G
24	0.15	24	0.15	7.2	14 – 36	82	84	24IMS7-24-24-9	Z, G
24	0.15	24	0.15	7.2	16.8 ² – 75	82	84	40IMX7-24-24-8	M, Z, G
24	0.15	24	0.15	7.2	36 – 75	82	84	48IMS7-24-24-9	Z, G
24	0.15	24	0.15	7.2	40 – 121	80	83	70IMX7-24-24-8	M, Z, G
24	0.15	24	0.15	7.2	60 – 150 ³	81	84	110IMX7-24-24-8	M, Z, G

¹ Flexible load distribution on double-outputs possible. If only one output is used, connect both outputs of double-output models in parallel.

² Operation at low input voltage possible, if P_o is reduced to approx. 80% of $P_o \text{ nom}$ at $V_{i \text{ min}} = 14.1 \text{ V}$.

³ Up to 154 V for 2 s

NFND: Not for new designs. Preferred for new designs

Note: Use 20IMX7 to replace 24IMS7 and 40IMX7 to replace 48IMS7.

Part Number Description

Input voltage range V_i

8.4 – 36 V	20
14 – 36 V	24
16.8 – 75 V	40
36 – 75 V	48
40 – 121 V	70
60 – 150 V	110

Series IMX7, IMS7

Output voltage of output 1 03, 05, 12, 15, 24

Output voltage of output 2 05, 12, 15, 24

Operating ambient temperature T_A

–40 to 85 °C	-8
–40 to 71 °C	-9

Options: Surface mount version¹ **M**
 Open frame¹ **Z**
 RoHS-compliant for all six substances **G**

Obsolete option: C-pinout **C**

¹ Option M and Z exclude each other.

Note: The sequence of options must follow the order above.

Example: 40IMX7-05-05-8ZG: DC-DC converter, input voltage range 16.8 – 75 V, 2 outputs providing each 5 V, 700 mA, temperature range –40 to 85 °C, open frame, RoHS compliant for all six substances.

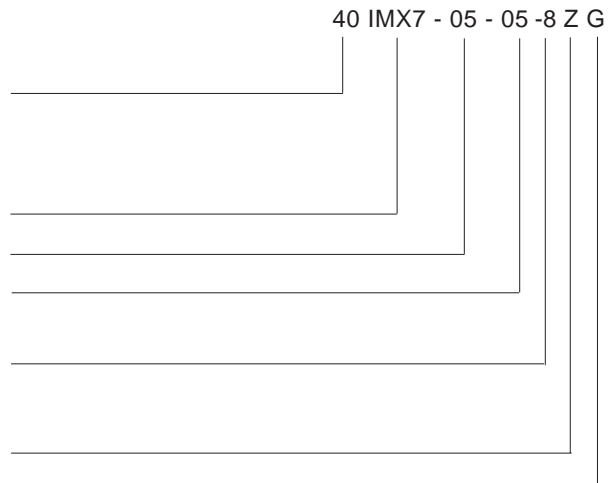

Functional Description

The IMX7/IMS7 Series DC-DC converters are feedback-controlled flyback converters using current mode PWM (Pulse Width Modulation).

In the case of single-output models, the output is directly sensed and fed back to the primary control circuit via a pulse transformer, resulting in tight regulation of the output voltage. The R input is referenced to the secondary side and allows for programming the output voltages in the range 75 to 105% of $V_{o\ nom}$, using either an external resistor or an external voltage source.

For double-output models, the output voltage is sensed by a separate transformer winding close to the secondary and fed

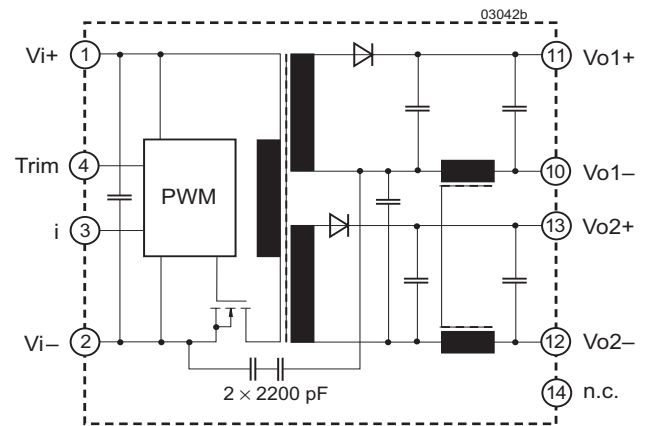

Fig. 2
 Block diagram of double-output models

back to the primary control circuit. Close magnetic coupling is provided by the planar construction, ensuring very good regulation, and allowing for flexible load distribution. The Trim input of double-output models is referenced to the primary side, and allows for programming the output voltages in the range of 100 to 105% of $V_{o\ nom}$ by means of an external resistor, or within 75 to 100% of $V_{o\ nom}$, using an external voltage source.

Current limitation is provided by the primary circuit, thus limiting the total output current ($I_{o\ nom}$ for the single- and the sum $I_{o1\ nom} + I_{o2\ nom}$ for double-output models).

The inhibit input i allows remote control of the outputs; pin i must be connected to V_{i-} to activate the converter.

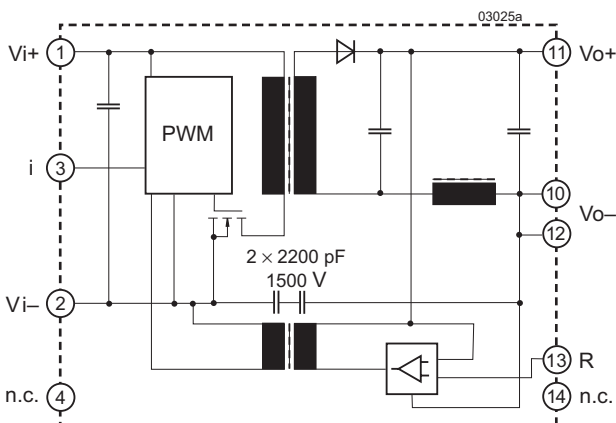

Fig. 1
 Block diagram of single-output models

Electrical Input Data

General conditions:

- $T_A = 25\text{ °C}$, unless T_C is specified.
- Connector pin i connected with V_{i-} .
- Trim or R input not connected.

Table 2a: Input data of IMX7

Input			20IMX7			40IMX7			70IMX7			110IMX7			Unit
Characteristics		Conditions	min	typ	max	min	typ	max	min	typ	max	min	typ	max	
V_i	Input voltage range ¹	$T_C \text{ min} - T_C \text{ max}$ $I_o = 0 - I_o \text{ nom}$	8.4	36		16.8 ⁶	75		40	121		60	150 ⁷	V	
$V_{i \text{ nom}}$	Nominal input voltage		20			40			70			110			
$V_{i \text{ sur}}$	Repetitive surge voltage	abs. max input (3 s)		50 ⁵			100			150					
$t_{\text{start up}}$	Converter ² start-up time	switch on	0.25		0.5		0.25		0.5		0.25		0.5		s
		inh. release			0.1				0.1				0.1		
t_{rise}	Rise time ²	$V_{i \text{ nom}}$ resistive load	5		5		5		5		5		5		ms
		$I_o \text{ nom}$ capacitive load	12		12		12		12		12		12		
$I_{i \text{ o}}$	No load input current	$I_o = 0, V_{i \text{ min}} - V_{i \text{ max}}$	15	30		8	15		8	15		8	15	mA	
C_i	Input capacitance	(for surge calculation)	4.7		0.5		0.2		0.2		0.2		0.2		μF
$V_{i \text{ inh}}$	Inhibit voltage	converter operating	-10	+0.8		-10	+0.8		-10	+0.8		-10	+0.8	V	
		converter inhibited	2.4	$V_{i \text{ max}}$		2.4	$V_{i \text{ max}}$		2.4	$V_{i \text{ max}}$		2.4	$V_{i \text{ max}}$		
$I_{i \text{ inh}}$	Inhibit current	converter operating	-0.5		-0.5		-0.5		-0.5		-0.5		-0.5		mA
		converter inhibited	1		1		1		1		1		1		
$I_{i \text{ inh}}$	Input current when the converter is inhibited	$V_{i \text{ min}} - V_{i \text{ max}}$	3		3		3		3		3		3		
$I_{i \text{ nr p}}$	Inrush peak current	$V_i = V_{i \text{ nom}}$ ⁴	3.8		3.7		4.2		5.6		5.6		A		
f_s	Switching frequency	$V_{i \text{ min}} - V_{i \text{ max}}, I_o = 0 - I_o \text{ nom}$	approx. 400		approx. 400		approx. 400		approx. 300		approx. 300		kHz		
$I_{i \text{ rr}}$	Reflected ripple current	$I_o = 0 - I_o \text{ nom}$	50		30		20		10		10		mA _{pp}		
$V_{i \text{ RFI}}$	Input RFI level conducted	EN 55022 ³	A		A		A		A		A		A		

¹ $V_{i \text{ min}}$ will not be as stated, if V_o is increased above $V_o \text{ nom}$ by use of the R or Trim input. If the output voltage is set to a higher value, $V_{i \text{ min}}$ will be proportionally increased.

² Measured with a resistive and the max. admissible capacitive load.

³ Measured with a lead length of 0.1 m, leads twisted. Double-output models with both outputs in parallel. 70/110 IMX7 models need an external capacitor at the input, e.g., 1 μF film or ceramic.

⁴ Source impedance according to ETS 300132-2, version 4.3, at $V_{i \text{ nom}}$.

⁵ The DC-DC converter shuts down automatically at approx. 38 V.

⁶ Operation at lower input voltage possible: P_o approx. 80% of $P_o \text{ nom}$ at $V_{i \text{ min}} = 14.4\text{ V}$.

⁷ Up to 154 V for 2 s

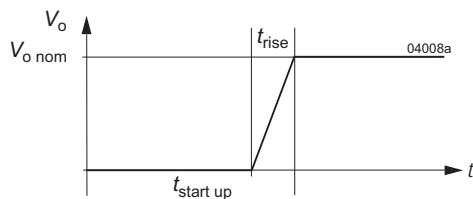

Fig. 3

Converter start-up and rise time

Table 2b: Input data of IMS7; general conditions as in table 2a

Input			24IMS7			48IMS7			Unit
Characteristics		Conditions	min	typ	max	min	typ	max	
V_i	Input voltage range ¹	$T_{C\ min} - T_{C\ max}$	14		36	36		75	V
$V_{i\ nom}$	Nominal input voltage	$I_o = 0 - I_{o\ nom}$		24			48		
$V_{i\ sur}$	Repetitive surge voltage	abs. max input (3 s)			50			100	
$t_{start\ up}$	Converter ² start-up time	switch on	Worst case condition at $V_{i\ min}$ and full load		0.4	0.6	0.3	0.6	s
		inh. release				0.1		0.1	
t_{rise}	Rise time ²	$V_{i\ nom}$	resistive load		5		5		ms
		$I_{o\ nom}$	capacitive load		12		12		
$I_{i\ o}$	No load input current	$I_o = 0, V_{i\ min} - V_{i\ max}$	12	24		6	12		mA
C_i	Input capacitance	(for surge calculation)	0.8			0.5			μ F
V_{inh}	Inhibit voltage	converter operating	-10		+0.8	-10		+0.8	V
		converter inhibited	2.4	or open	$V_{i\ max}$	2.4	or open	$V_{i\ max}$	
I_{inh}	Inhibit current	converter operating	-0.5			-0.5			mA
		converter inhibited	1			1			
$I_{i\ inh}$	Input current when the converter is inhibited	$V_{i\ min} - V_{i\ max}$	3			3			
$I_{inr\ p}$	Inrush peak current	$V_i = V_{i\ nom}$ ⁴	4.0			3.9			A
f_s	Switching frequency	$V_{i\ min} - V_{i\ max}, I_o = 0 - I_{o\ nom}$	approx. 330			approx. 330			kHz
$I_{i\ rr}$	Reflected ripple current	$I_o = 0 - I_{o\ nom}$	40			30			mA _{pp}
$V_{i\ RFI}$	Input RFI level conducted	EN 55022 ³	A			A			

¹ $V_{i\ min}$ will not be as stated, if V_o is increased above $V_{o\ nom}$ by use of the R or Trim input. If the output voltage is set to a higher value, $V_{i\ min}$ will be proportionally increased.

² Measured with a resistive and the max. admissible capacitive load.

³ Measured with a lead length of 0.1 m, leads twisted. Double-output models with both outputs in parallel. 70/110 IMX7 models need an external capacitor at the input, e.g. 1 μ F film or ceramic.

⁴ Source impedance according to ETS 300132-2, version 4.3, at $V_{i\ nom}$

Input Transient Voltage Protection

In many applications transient voltages on the input of the converter may occur and are possibly caused by short circuits between V_{i+} and V_{i-} , where the network inductance may cause high energy pulses.

In order to protect the converters, transient suppressors are fitted to the input; see table below:

Table 3: Built-in transient voltage suppressor

Model	Breakdown Voltage $V_{BR\ nom}$	Peak Power at 1 ms P_P	Peak Pulse Current I_{PP}
20IMX7 ¹	overvoltage lockout at approx. 38 V		
24IMS7 ²	53 V	600 W	7.7 A
40IMX7 ²	100 V	1500 W	11 A
48IMS7 ²	100 V	600 W	4.1 A
70IMX7 ²	144 V	600 W	2.9 A
110IMX7 ²	167 V	600 W	2.5 A

¹ The built-in overvoltage trigger shuts down the converter at approx. 38 V protecting the input up to 50 V. For higher transient voltages an external suppressor or voltage limiting circuit as, e.g., for IEC/EN 61000-4-5, level 2 compliance should be provided.

² If transients generating currents above the peak pulse current are possible, an external limiting network such as the circuit recommended for IEC/EN 61000-4-5, level 2 compliance, is necessary.

To achieve IEC/EN 61000-4-5, level 2 compliance, an additional inductor and capacitor should be provided externally as shown in the figure below. The components should have similar characteristics as listed in table 4.



Fig. 4

Example for external circuitry to comply with IEC/EN 61000-4-5, level 2 (transzorb D only for 20IMX7).

Table 4: Components for external circuitry to comply with IEC/EN 61000-4-5, see table 8

Model	L	C	D
20IMX7	330 μ H, 1 A, 0.115 Ω	68 μ F, 63 V	1.5KE39A
24IMS7	–	–	–
40IMX7	330 μ H, 0.6 A, 0.42 Ω	47 μ F, 100 V	1.5KE100A
48IMS7	–	–	–
70IMX7	1000 μ H, 0.6 A, 0.42 Ω	22 μ F, 160 V	1.5KE120A
110IMX7	330 μ H, 0.2 A	22 μ F, 200 V	1.5KE170A

Note: Suppressor diode D is only necessary for 20IMX7 models. To withstand 150 V transients according to 19 Pfl 1, applicable for 40IMX7 models, the same external circuitry with similar components as for IEC/EN 61000-4-5, level 2 compliance can be used.

Input Fuse and Reverse Polarity Protection

The suppressor diode on the input also provides for reverse polarity protection by conducting current in the reverse direction, thus protecting the converter. An external fuse is required to limit this current. We recommend for:

- 20IMX7 and 24IMS7 a fast 2 A (F2A) fuse
- 40IMX7 and 48IMS7 a fast 1 A (F1A) fuse
- 70IMX7 a fast 0.63 A (F.63A) fuse
- 110IMX7 a fast 0.63 A (F.63A) fuse.

Inrush Current

The inrush current has been kept as low as possible by choosing a very small input capacitance. A series resistor may be inserted in the input line to limit this current further.



Fig. 5

Typical inrush current at $V_{i\ nom}$, $P_{o\ nom}$ measured according to ETS 300132-2 (40IMX7).

Electrical Output Data

General conditions:

- $T_A = 25\text{ °C}$, unless T_C is specified.
- Pin i connected with V_i –; Trim or R input left open-circuit.

Table 5a: Output data for single-output models

Output		V_o nom	3.3 V			5.1 V		Unit
Characteristics		Conditions	min	typ	max	min	typ	
V_o	Output voltage setting	$V_{i\text{ nom}}$	3.28	3.32	5.07	5.13		V
I_o nom	Output current (nom.)	$V_{i\text{ min}} - V_{i\text{ max}}$	1.5		1.2			A
I_o L	Current limit ²	$V_{i\text{ nom}}$	1.78	2.7	1.56	2.0		
ΔV_o	Line and load regulation	$V_{i\text{ min}} - V_{i\text{ max}}$ $I_o = (0.05 - 1) I_o$ nom	± 1		± 1			%
v_o	Output voltage noise	$V_{i\text{ min}} - V_{i\text{ max}}$ $I_o = I_o$ nom ⁵	70		70			mV _{pp}
		other models ⁶	20	40	20	40		
		110IMX7	40	50	40	50		
V_o clp	Output overvoltage limit ⁷	Minimum load 1%	115	130	115	130		%
C_o ext	Admissible capacitive load		0	2500	0	2000		μF
V_o d	Dynamic load regulation	Voltage deviat.	± 250		± 250			mV
t_d		Recovery time	1		1			ms
α_{V_o}	Temperature coefficient $\Delta V_o / \Delta T_C$ (T_C min to T_C max)	$V_{i\text{ min}} - V_{i\text{ max}}$ $I_o = (0.05 - 1) I_o$ nom	± 0.02		± 0.02			%/K

Table 5b: Output data for double-output models

Output		V_o nom	2 x 5 V			2 x 12 V		2 x 15 V		2 x 24 V		Unit
Characteristics		Conditions	min	typ	max	min	typ	max	min	typ	max	
V_{o1} V_{o2}	Output voltage setting	IMX7 $V_{i\text{ nom}}$ $I_{o1} = I_{o2} = 0.5 I_o$ nom	4.96	5.04	11.90	12.10	14.88	15.12	23.81	24.19	V	
		IMS7 $V_{i\text{ nom}}$ $I_{o1} = I_{o2} = 0.5 I_o$ nom	4.92	5.08	11.82	12.18	14.78	15.22	23.64	24.36		
V_{o1} V_{o2}			4.92	5.08	11.82	12.18	14.78	15.22	23.64	24.36		
I_o nom	Output current (nom.) ¹	$V_{i\text{ min}} - V_{i\text{ max}}$	2 x 0.6		2 x 0.25		2 x 0.2		2 x 0.13		A	
	other models		2 x 0.7		2 x 0.3		2 x 0.24		2 x 0.15			
I_o L	Current limit ^{2 3}	$V_{i\text{ nom}}$	20IMX7	1.8	2.1	0.7	0.9	0.5	0.7	0.35	0.45	
			other models	1.8	2.0	0.8	1.0	0.55	0.9	0.38	0.5	
ΔV_{o1}	Line regulation	$V_{i\text{ min}} - V_{i\text{ max}}, I_o$ nom	± 1		± 1		± 1		± 1		%	
ΔV_{o1}	Load regulation ⁴	$V_{i\text{ nom}}, (0.1 - 1) I_o$ nom	± 3		± 3		± 3		± 3			
$v_{o1, 2}$	Output voltage noise	$V_{i\text{ min}} - V_{i\text{ ma}}$ $I_o = I_o$ nom ⁵	80		120		150		240		mV _{pp}	
		⁶	20	40	25	50	30	60	50	100		
V_o clp	Output overvoltage limit ⁷	Minimum load 1%	115	130	115	130	115	130	115	130	%	
C_o ext	Admissible capacitive load ³		0	2000	0	300	0	200	0	100	μF	
V_o d	Dynamic load regulation	Voltage deviat.	± 150		± 330		± 350		± 600		mV	
t_d		Recovery time	1		1		1		1		ms	
α_{V_o}	Temperature coefficient of output voltage	$V_{i\text{ min}} - V_{i\text{ max}}$ $(0.05 - 1) I_o$ nom	± 0.02		± 0.02		± 0.02		± 0.02		%/K	

¹ Each output is capable of delivering full output power P_o nom according to table Model Selection.

² The current limit is primary side controlled. I_o L is defined when V_o dropped to 85 to 94%.

³ Measured with both outputs connected in parallel.

⁴ Conditions for specified output. Other output loaded with constant current $I_o = 0.5 I_o$ nom.

⁵ BW = 20 MHz

⁶ Measured with a probe according to EN 61204.

⁷ The overvoltage protection is not tracking with the R control.

Thermal Considerations

If the converter, mounted on a PCB, is located in free, quasi-stationary air (convection cooling) at the maximum ambient temperature $T_{A \max}$ (see table *Temperature specifications*) and is operated at nominal input voltage and output power, the case temperature T_C measured at the measuring point of case temperature (see *Mechanical Data*) will approach $T_{C \max}$ after the warm-up phase. However, the relationship between T_A and T_C depends heavily on the conditions of operation and integration into a system, such as input voltage, output current, airflow, temperature of surrounding components and surfaces, and the properties of the printed circuit board. $T_{A \max}$ is therefore only an indicative value, and under practical operating conditions, T_A may be higher or lower.

Caution: The case temperature T_C measured at the measuring point of case temperature (see *Mechanical Data*) may under no circumstances exceed the specified maximum. The installer must ensure that under all operating conditions T_C remains within the limits stated in the table *Temperature specifications*.

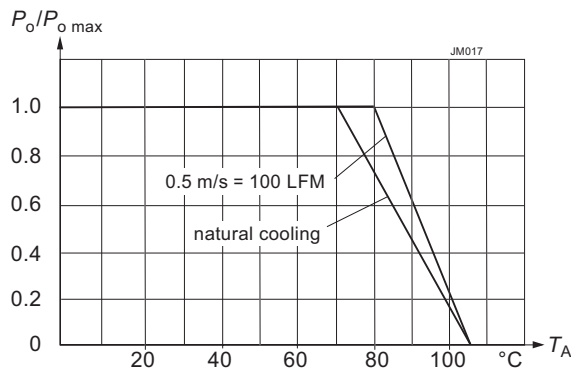

Fig. 6
 Maximum allowed output power versus ambient temperature

Short-Circuit Behavior

The current limitation shuts down the converter, when a short circuit is applied to the output. It acts self-protecting, and automatically recovers after removal of the overload condition.



Fig. 7
 Overload switch-off (hiccup mode).

Output Overvoltage Protection

The outputs are protected against overvoltage by Zener diodes. In the event of an overvoltage, the converter will shut down and attempt to restart automatically. The main purpose of this feature is to protect against possible overvoltage, which could occur due to a failure in the feedback control circuit. The converters are not designed to withstand external overvoltages applied to the outputs.

Connection in Series or Parallel

The outputs of single- or double-output models can be connected in series without any precautions, taking into consideration that the output voltage should remain below 60 V for SELV operation.

Both outputs of double-output models can be connected in parallel without any precautions. Several converters (single- or double-output models) with equal output voltage can be put in parallel and will share their output current quite equally. However, this may cause start-up problems and is only recommended in applications, where one converter is able to deliver the full load current, e.g., in true redundant systems.

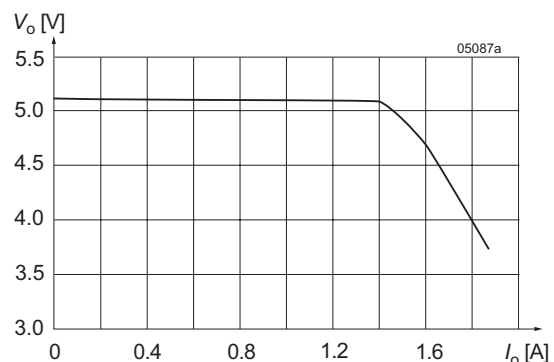

Fig. 8a
 V_o versus I_o (typ.) of single-output models with $V_o = 5.1$ V

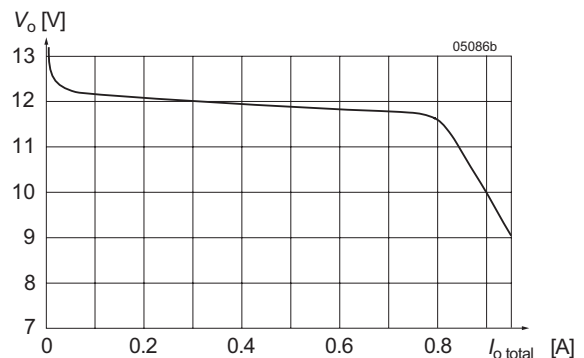

Fig. 8b
 V_o versus I_o (typ.) of double-output models (2×12 V) with both outputs in parallel

Typical Performance Curves



Fig. 9
 Cross load regulation (typ.) of double-output models (2×12 V). The cross-load effect is negligible.



Fig. 11
 Efficiency versus input voltage and load. Typical values (40IMX7-12-12-8).



Fig. 10
 Flexible load distribution on double-outputs models (2×12 V) with load variation from 0 to 150% of $P_{o1, \text{nom}}$ on output 1. Output 2 loaded with 25% of $P_{o2, \text{nom}}$.

Auxiliary Functions

Inhibit Function

The output(s) of the converter may be enabled or disabled by means of a logic signal (TTL, CMOS, etc.) applied to the inhibit pin. No output voltage overshoot will occur, when the converter is turned on. If the inhibit function is not required, the inhibit pin should be connected to V_i^- to enable the output (active low logic, fail safe).

Converter operating:	-10 V to 0.8 V	
Converter inhibited or inhibit pin i left open:	2.4 V to $V_{i, \text{max}}$	(20/40IMX7, 24/48IMS7)
	2.4 V to 75 V	(70/110IMX7)

Adjustable Output Voltage

As a standard feature, all IMX7 and IMS7 converters offer adjustable output voltage(s) by using a control pin. If this pin is left open-circuit, the output voltage is set to $V_{o, \text{nom}}$. The output voltage is adjustable in the range of 75 to 105% of $V_{o, \text{nom}}$. The circuit works for single- and double-output models in a different way. For output voltages $V_o > V_{o, \text{nom}}$, the minimum input voltage $V_{i, \text{min}}$ (see *Electrical Input Data*) increases proportionally to $V_o / V_{o, \text{nom}}$.

Single-output models with R-input:

The R-input (pin 13) is referenced to the secondary side of the converter. Adjustment of the output voltage is possible by means of either an external resistor or a voltage source.



Fig. 12
 Output voltage adjust for single-output models

- a) Adjustment by means of an external resistor:
 Depending upon the value of the required output voltage, a resistor R_{ext1} or R_{ext2} shall be connected as shown in the figure below:
Either: R_{ext1} between the R pin and V_{o-} to achieve an output voltage adjustment range of $V_o = 75$ to 100% of $V_{o\ nom}$ (85 to 100% for 3.3 V outputs):

$$R_{ext1} \approx 4\text{ k}\Omega \cdot \frac{V_o}{V_{o\ nom} - V_o}$$

or: R_{ext2} between the R pin and V_{o+} to achieve an output voltage range of approximately $V_o = 100$ to 105% of $V_{o\ nom}$:

$$R_{ext2} \approx 4\text{ k}\Omega \cdot \frac{(V_o - 2.5\text{ V})}{2.5\text{ V} \cdot (V_o/V_{o\ nom} - 1)}$$

- b) Adjustment by means of an external voltage V_{ext} between V_{o-} and R pin.
 The control voltage is 1.96 to 2.62 V and allows for adjustment in the range of 75 to 105% of $V_{o\ nom}$.

$$V_{ext} \approx \frac{V_o \cdot 2.5\text{ V}}{V_{o\ nom}}$$

Caution: Applying an external voltage $>2.75\text{ V}$ may damage the converter.

Note: Attempting to adjust the output below this range will cause the converter to shut down (hiccup mode).

Double-output models with Trim input:

The Trim input (pin 4) of double-output models is referenced to the primary side. Figure 13 shows the circuitry. Adjustment of the output voltage is possible in the range of 100 to 105% of V_o using an external resistor, or in the range of 75 to 105% of V_o using an external voltage source.

- a) Adjustment by means of an external resistor R_{ext} .
 Programming of the output voltage by means of an external resistor R_{ext1} is possible within a limited range of

100 to 105% $V_{o\ nom}$. R_{ext} should be connected between pin 4 and V_{i-} . The following table indicates suitable resistor values for typical output voltages under nominal conditions ($V_{i\ nom}$, $I_o = 0.5 I_{o\ nom}$), with paralleled outputs or equal load conditions on each output.

Caution: Connection of R_{ext} to V_{i+} may damage the converter.



Fig. 13
 Output voltage adjust for double-output models

Table 6: R_{ext} for $V_o > V_{o\ nom}$
 approximate values ($V_{i\ nom}$, $I_{o1} = I_{o2} = 0.5 I_{o1/2\ nom}$)

V_o [% $V_{o\ nom}$]	R_{ext} [kΩ]
105 to 108 (107 typically)	0
105	1.5
104	5.6
103	12
102	27
101	68
100	∞

Note: Applying a control voltage greater than 20 V will set the converter into a hiccup mode.

- b) Adjustment by means of an external voltage source V_{ext} .
 For external output voltages in the range of 75 to 105% of $V_{o\ nom}$ a voltage source V_{ext} (0 to 20 V) is required, connected to the Trim-input (pin 4) and V_{i-} . The table below indicates typical V_o versus V_{ext} values under nominal conditions ($V_{i\ nom}$, $I_o = 0.5 I_{o\ nom}$), with paralleled outputs or equal load conditions on each output. Direct paralleling of the Trim-inputs of converters connected in parallel is feasible.

Table 7: V_{ext} for $V_o = 75$ to 105% $V_{o\ nom}$;
 typical values ($V_{i\ nom}$, $I_{o1} = I_{o2} = 0.5 I_{o1/2\ nom}$)

V_o [% $V_{o\ nom}$]	V_{ext} [V]
≥ 105	0
102	1.6
95	4.5
85	9
75	13

Electromagnetic Compatibility (EMC)

A suppressor diode together with an input filter form an effective protection against high input transient voltages, which

typically occur in many installations, but especially in battery-driven mobile applications.

Electromagnetic Immunity

Table 8: Immunity type tests

Phenomenon	Standard	Class level	Coupling mode ¹	Value applied	Waveform	Source imped.	Test procedure	In oper.	Perf. crit. ²
Electrostatic discharge to case ⁵	IEC/EN 61000-4-2	2	contact discharge	4000 V _p	1/50 ns	330 Ω	10 positive and 10 negative discharges	yes	B
		3	air discharge	8000 V _p					
Electromagnetic field	IEC/EN	3 ⁶ 2 ³	antenna	10 V/m 3 V/m ³	AM 80% 1 kHz	n.a.	80 – 1000 MHz	yes	A
	ENV 50204	3 2 ³	antenna	10 V/m 3 V/m ³	PM, 50% duty cycle, 200 Hz repetition frequ.	n.a.	900 MHz	yes	A
Electrical fast transients/burst	IEC/EN 61000-4-4	4 3 ³	direct +i/-i	4000 V _p 2000 V _p ³	bursts of 5/50 ns 5 kHz repet. rate, transients with 15 ms burst duration, and 300 ms period	50 Ω	60 s positive, 60 s negative transients per coupling mode	yes	B
Surges	IEC/EN 61000-4-5	2 ⁴ 1 ³ 4	+i/-i	1000 V _p 500 V _p ³	1.2/50 μs	42 Ω 0.5 μF	5 pos. and 5 neg. surges	yes	B
RF conducted immunity	IEC/EN 61000-4-6	3 2 ³	+i/-i	10 VAC 3 VAC	AM modul. 80% 1 kHz	50 Ω	0.15 to 80 MHz 150 Ω	yes	A

¹ i = input, o = output

² Performance criterion: A = normal operation, no deviation from specifications, B = temporary deviation from specs possible

³ Valid for 24IMS7 and 48IMS7

⁴ External components required

⁵ R or Trim pin open, i pin connected with Vi-

⁶ Corresponds to the railway standard EN 50121-3-2:2000, table 9.1

Electromagnetic Emissions



Fig. 14a

20IMX7-15-15-8: Typical conducted emissions (peak) at the input at $V_{i\text{nom}}$ and $I_{o\text{nom}}$ according to EN 55011/22. Output leads 0.1 m, twisted. External input capacitor (1 μF ceramic + 100 μF electrolytic cap)



Fig. 14b

40IMX7-24-24-8: Typical conducted emissions (peak) at the input at $V_{i\text{nom}}$ and $I_{o\text{nom}}$ according to EN 55011/22. Output leads 0.1 m, twisted. External input capacitor (1 μF ceramic + 47 μF electrolytic cap)

Fig. 14c

110IMX7-05-8: Typical conducted emissions (peak) at the input at $V_{i\text{nom}}$ and $I_{o\text{nom}}$ according to EN 55011/22. Output leads 0.1 m, twisted. External input capacitor (0.15 μF ceramic + 4.7 μF electrolytic cap).

Fig. 15

48IMS7-15-15-8: Typical conducted emissions (peak) at the input at $V_{i\text{nom}}$ and $I_{o\text{nom}}$ according to EN 55011/22. Output leads 0.1 m, twisted. External input capacitor (1 μF ceramic + 47 μF electrolytic cap).

Immunity to Environmental Conditions

Table 9: Mechanical and climatic stress

Test Method		Standard	Test conditions	Status
Cab	Damp heat steady state	IEC/EN 60068-2-78 MIL-STD-810D section 507.2	Temperature: 40 \pm 2 $^{\circ}\text{C}$ Relative humidity: 93 \pm 2/-3 % Duration: 56 days	Converter not operating
Ea	Shock (half-sinusoidal)	IEC/EN 60068-2-27 ¹ MIL-STD-810D section 516.3	Acceleration amplitude: 100 $g_n = 981 \text{ m/s}^2$ Bump duration: 6 ms Number of bumps: 18 (3 each direction)	Converter operating
Eb	Bump (half-sinusoidal)	IEC/EN 60068-2-29 MIL-STD-810D section 516.3	Acceleration amplitude: 40 $g_n = 392 \text{ m/s}^2$ Bump duration: 6 ms Number of bumps: 6000 (1000 each direction)	Converter operating
Fc	Vibration (sinusoidal)	IEC/EN 60068-2-6	Acceleration amplitude: 0.35 mm (10 to 60 Hz) 5 $g_n = 49 \text{ m/s}^2$ (60 to 2000 Hz) Frequency (1 Oct/min): 10 to 2000 Hz Test duration: 7.5 h (2.5 h each axis)	Converter operating
Fh	Vibration, broad-band random (digital control)	IEC/EN 60068-2-64	Acceleration spectral density: 0.05 g_n^2/Hz Frequency band: 10 to 500 Hz Acceleration magnitude: 4.9 $g_{n\text{rms}}$ Test duration: 3 h (1 h each axis)	Converter operating
Kb	Salt mist, cyclic (sodium chloride NaCl solution)	IEC/EN 60068-2-52	Concentration: 5% (30 $^{\circ}\text{C}$) Duration: 2 h per cycle Storage: 40 $^{\circ}\text{C}$, 93% rel. humidity Storage duration: 22 h per cycle Number of cycles: 3	Converter not operating

¹ Covers also EN 50155/EN 61373 category 1, class B, body mounted (= chassis of coach)

Temperatures

Table 10: Temperature specifications, valid for air pressure of 800 to 1200 hPa (800 to 1200 mbar)

Temperature			-9		-8		Unit
Characteristics		Conditions	min	max	min	max	
T_A	Ambient temperature	Operational ¹	-40	71	-40	85	$^{\circ}\text{C}$
T_C	Case temperature		-40	95	-40	105	
T_S	Storage temperature	Non operational	-55	100	-55	105	

¹ See Thermal Considerations

Failure Rates

Table 11: MTBF and device hours

Model	Standard	Ground benign	Ground fixed		Ground mobile	Unit
		$T_C = 40\text{ }^\circ\text{C}$	$T_C = 40\text{ }^\circ\text{C}$	$T_C = 70\text{ }^\circ\text{C}$	$T_C = 50\text{ }^\circ\text{C}$	
24IMS7-05-9	MIL-HDBK-217F	634 000	321 000	188 000	271 000	h
40IMX7-12-12-8	MIL-HDBK-217F	851 000	395 000	253 000	342 000	
	Bellcore	3 019 000	1 510 000	809 000	409 000	
40IMX7-05-05-8	Bellcore	3 320 000	1 660 000	871 000	447 000	

Mechanical Data

Dimensions in mm (inches).
 Tolerances ± 0.3 mm,
 unless otherwise noted.
 Material: PPS Fortron 1140L6

Weight: <20 g

Fig. 16

Case IMX7/IMS7 with
 standard pinout

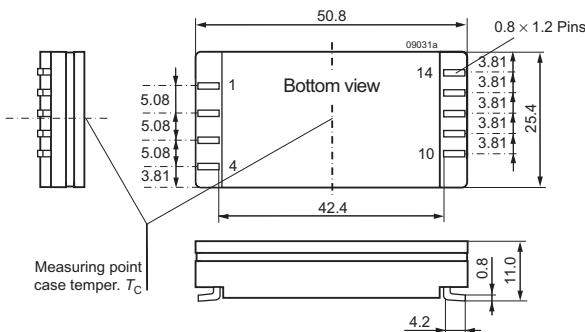

Fig. 17

SMD pins (option M)

Fig. 18

Open-frame
 model (option Z)



Safety and Installation Instructions

Pin Allocation



Fig. 19

Footprint

Table 12: Pin allocation

Pin	Single output	Double output
1	Vi+	Vi+
2	Vi-	Vi-
3	i	i
4	n.c.	Trim
10	Vo-	Vo1-
11	Vo+	Vo1+
12	Vo-	Vo2-
13	R	Vo2+
14	n.c.	n.c.

Installation Instruction

Installation of the converters must strictly follow the national safety regulations in compliance with the enclosure, mounting, creepage, clearance, casualty, markings, and segregation requirements of the end-use application.

Connection to the system shall be made via a printed circuit board; see *Mechanical Data*.

The converters should be connected to a secondary circuit.

Do not open the converter.

Ensure that a converter failure does not result in a hazardous conditions.

To prevent excessive current flowing through the input lines in case of a short-circuit, an external fuse specified in section *Input Fuse and Reverse Polarity Protection* should be installed in the non-earthed input supply line.

Standards and Approvals

The converters are approved according to IEC 60950-1 and UL/CSA 60950-1 2nd Edition.

The converters have been evaluated for:

- Building-in
- Basic insulation input to output, based on their maximum input voltage
- Pollution degree 2 environment
- Connecting the input to a secondary circuit, which is subject to a maximum transient rating of
 - 1500 V for 20IMX7, 24IMS7, 40IMX7, 48IMS7
 - 2000 V for 70IMX7
 - 2500 V for 110IMX7.

The converters are subject to manufacturing surveillance in accordance with the above mentioned standards.

Railway Applications

To comply with railway standards, all components are coated with a protective lacquer (except option Z).

Protection Degree and Cleaning Liquids

The protection degree of the converters is IP 30, except open-frame models (option Z).

In order to avoid possible damage, any penetration of cleaning fluids should be prevented, since the power supplies are not hermetical sealed.

However, open-frame models (option Z) leave the factory unlacquered; they may be lacquered by the customer, for instance together with the mother board. Cleaning agents are not permitted – except washing at room temperature with isopropyl alcohol. If necessary, the mother board must be cleaned, before fitting the open-frame converter.

Note: Cleaning liquids may damage the adhesive joints of the ferrite cores.

Isolation

The electric strength test is performed in the factory as a routine test in accordance with EN 50514 and IEC/EN 60950, and should not be repeated in the field. The Company will not honor any warranty claims resulting from electric strength field tests.

Table 12: Electric strength test voltages

Characteristic	Input to output			o/o ³	Unit
	20/40IMX 24/48IMS	20/40IMX ² 70IMX	110IMX		
Factory test >1 s	1.2	1.5 ¹	2.0	0.1	kVAC
Equivalent DC volt.	(1.5)	(2.1)	(2.5)	0.15	kVDC
Coupling capacitance	1.2	1.2	1.2	–	nF
Insulation resist. at 500 VDC	>100	>100	>100	–	MΩ

¹ 1.5 kVAC according to IEC 60950, sect. 6.2, Telecom equipment; type test with 1.5 kVAC / 60 s (IEE 802.3).=

² 20/40IMX7 produced 2014 or later.

³ The test voltage between outputs is not applied as routine test.

Description of Options

Option M: SMD pins

This option allows surface mounting of the converters.

Option Z: Open Frame

For applications, where the protection by a housing is not

necessary or in the case that the motherboard should be lacquered after fitting the converter; see *Cleaning Liquids*.

Option G: RoHS-6

Converters with a type designation ending by G are RoHS-compliant for all six substances.

NUCLEAR AND MEDICAL APPLICATIONS - These products are not designed or intended for use as critical components in life support systems, equipment used in hazardous environments, or nuclear control systems.

TECHNICAL REVISIONS - The appearance of products, including safety agency certifications pictured on labels, may change depending on the date manufactured. Specifications are subject to change without notice.

Copyright © 2015, Bel Power Solutions Inc. All rights reserved.

www.belpowersolutions.com/power

Mouser Electronics

Authorized Distributor

Click to View Pricing, Inventory, Delivery & Lifecycle Information:

Bel Power Solutions:

[20IMX7-24-24-8G](#) [110IMX7-05-05-8G](#) [40IMX7-24-24-8G](#) [20IMX7-12-12-8G](#) [20IMX7-05-8G](#) [40IMX7-05-05-8G](#)
[70IMX7-05-8G](#) [40IMX7-15-15-8G](#) [20IMX7-05-05-8G](#) [20IMX7-15-15-8G](#) [40IMX7-12-12-8G](#) [110IMX7-05-8G](#)
[110IMX7-24-24-8G](#) [40IMX7-03-8G](#) [70IMX7-05-05-8G](#) [110IMX7-12-12-8G](#) [40IMX7-05-8G](#) [70IMX7-03-8G](#) [70IMX7-](#)
[12-12-8G](#) [110IMX7-15-15-8G](#) [20IMX7-03-8G](#) [70IMX7-15-15-8](#) [24IMS7-05-9](#) [110IMX7-05-05-8](#) [110IMX7-24-24-8](#)
[70IMX7-15-15-8G](#) [20IMX7-12-12-8](#) [40IMX7-05-05-8](#) [24IMS7-05-05-9](#) [20IMX7-05-8](#) [70IMX7-05-05-8](#) [20IMX7-24-24-8](#)
[110IMX7-12-12-8](#) [20IMX7-05-05-8](#) [40IMX7-12-12-8](#) [70IMX7-12-12-8](#) [70IMX7-05-8](#) [110IMX7-05-8](#) [20IMX7-15-15-8](#)
[70IMX7-24-24-8](#) [24IMS7-12-12-9G](#) [20IMX7-15-15-8M](#)

Компания «Океан Электроники» предлагает заключение долгосрочных отношений при поставках импортных электронных компонентов на взаимовыгодных условиях!

Наши преимущества:

- Поставка оригинальных импортных электронных компонентов напрямую с производств Америки, Европы и Азии, а так же с крупнейших складов мира;
- Широкая линейка поставок активных и пассивных импортных электронных компонентов (более 30 млн. наименований);
- Поставка сложных, дефицитных, либо снятых с производства позиций;
- Оперативные сроки поставки под заказ (от 5 рабочих дней);
- Экспресс доставка в любую точку России;
- Помощь Конструкторского Отдела и консультации квалифицированных инженеров;
- Техническая поддержка проекта, помощь в подборе аналогов, поставка прототипов;
- Поставка электронных компонентов под контролем ВП;
- Система менеджмента качества сертифицирована по Международному стандарту ISO 9001;
- При необходимости вся продукция военного и аэрокосмического назначения проходит испытания и сертификацию в лаборатории (по согласованию с заказчиком);
- Поставка специализированных компонентов военного и аэрокосмического уровня качества (Xilinx, Altera, Analog Devices, Intersil, Interpoint, Microsemi, Actel, Aeroflex, Peregrine, VPT, Syfer, Eurofarad, Texas Instruments, MS Kennedy, Miteq, Cobham, E2V, MA-COM, Hittite, Mini-Circuits, General Dynamics и др.);

Компания «Океан Электроники» является официальным дистрибьютором и эксклюзивным представителем в России одного из крупнейших производителей разъемов военного и аэрокосмического назначения «JONHON», а так же официальным дистрибьютором и эксклюзивным представителем в России производителя высокотехнологичных и надежных решений для передачи СВЧ сигналов «FORSTAR».



JONHON

«JONHON» (основан в 1970 г.)

Разъемы специального, военного и аэрокосмического назначения:

(Применяются в военной, авиационной, аэрокосмической, морской, железнодорожной, горно- и нефтедобывающей отраслях промышленности)

«FORSTAR» (основан в 1998 г.)

ВЧ соединители, коаксиальные кабели,
кабельные сборки и микроволновые компоненты:

(Применяются в телекоммуникациях гражданского и специального назначения, в средствах связи, РЛС, а так же военной, авиационной и аэрокосмической отраслях промышленности).



Телефон: 8 (812) 309-75-97 (многоканальный)

Факс: 8 (812) 320-03-32

Электронная почта: ocean@oceanchips.ru

Web: <http://oceanchips.ru/>

Адрес: 198099, г. Санкт-Петербург, ул. Калинина, д. 2, корп. 4, лит. А