0.8% Low Voltage Detector with Output Delay

NO.EA-161-140819

OUTLINE

The R3116x series are CMOS-based voltage detector ICs with high detector threshold accuracy and ultra-low supply current, which can be operated at an extremely low voltage and is used for system reset as an example.

Each of these ICs consists of a voltage reference unit, a comparator, resistors for detector threshold setting, an output driver, a hysteresis circuit and an output delay circuit. The detector threshold is internally fixed with high accuracy and does not require any adjustment.

Two output types, Nch open drain type and CMOS type are available.

The R3116x series are operable at a lower voltage than that of the R3112x series, and can be driven by a single battery.

Three types of packages, SOT-23-5, SC-82AB, and DFN(PLP)1010-4 are available.

FEATURES

- Supply Current Typ. 0.35 μ A ($-V_{DET}=1.5V$, $V_{DD}=-V_{DET}+1V$)
- Operating Voltage Range.....0.5V to 6.0V ($T_{opt}=25^{\circ}C$)
- Detector Threshold Range.....0.7V to 5.0V (0.1V step)
- Detector Threshold Accuracy..... $\pm 0.8\%$ ($-V_{DET} \geq 1.5V$)
- Temperature-Drift Coefficient of Detector Threshold Typ. $\pm 30ppm/^{\circ}C$
- Built-in Output Delay Circuit..... Typ. 100ms with an external capacitor: 0.022 μ F
- Output Delay Time Accuracy..... $\pm 15\%$ ($-V_{DET} \geq 1.5V$)
- Output Types..... Nch Open Drain "L" and CMOS
- Packages DFN(PLP)1010-4, SC-82AB, SOT-23-5

APPLICATIONS

- CPU and Logic Circuit Reset
- Battery Checker
- Window Comparator
- Wave Shaping Circuit
- Battery Back-up Circuit
- Power Failure Detector

BLOCK DIAGRAMS

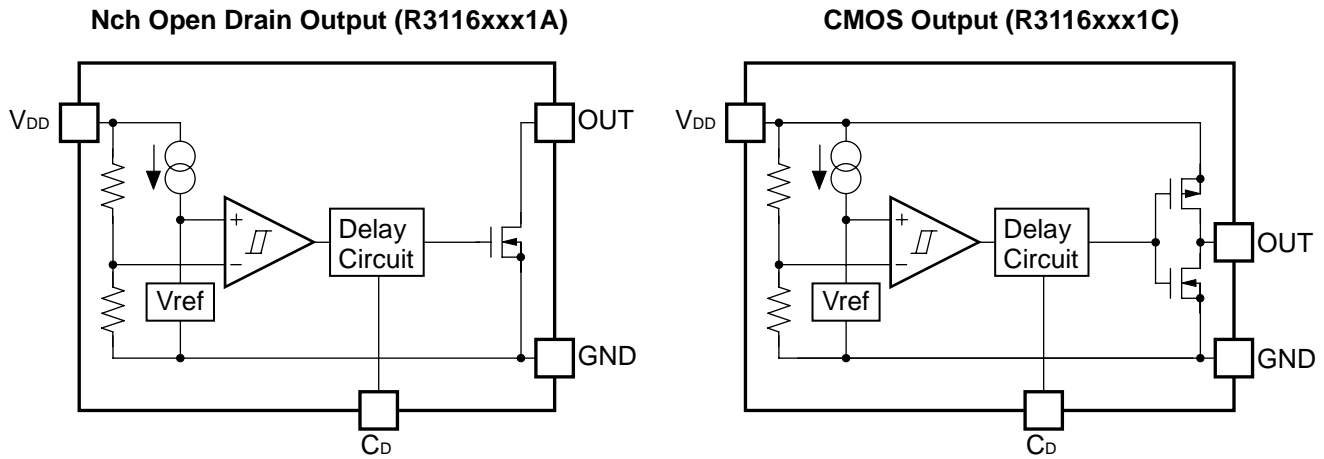

SELECTION GUIDE

The package type, the detector threshold, the output type and the taping type for the ICs can be selected at the users' request.

Product Name	Package	Quantity per Reel	Pb Free	Halogen Free
R3116Kxx1*-TR	DFN(PLP)1010-4	10,000 pcs	Yes	Yes
R3116Qxx1*-TR-FE	SC-82AB	3,000 pcs	Yes	Yes
R3116Nxx1*-TR-FE	SOT-23-5	3,000 pcs	Yes	Yes

xx: The detector threshold can be designated in the range from 0.7V(07) to 5.0V(50) in 0.1V step.

* : Designation of Output Type
 (A) Nch Open Drain
 (C) CMOS

PIN DESCRIPTIONS

• DFN(PLP)1010-4



• SOT-23-5



• SC-82AB



• DFN(PLP)1010-4

Pin No.	Symbol	Description
1	OUT	Output Pin ("L" at detection)
2	C _D	Pin for External Capacitor (for setting output delay)
3	GND	Ground Pin
4	V _{DD}	Input Pin

*) Tab is GND level. (They are connected to the reverse side of this IC.)

The tab is better to be connected to the GND, but leaving it open is also acceptable.

• SOT-23-5

Pin No.	Symbol	Description
1	OUT	Output Pin ("L" at detection)
2	V _{DD}	Input Pin
3	GND	Ground Pin
4	NC	No Connection
5	C _D	Pin for External Capacitor (for setting output delay)

• SC-82AB

Pin No.	Symbol	Description
1	V _{DD}	Input Pin
2	GND	Ground Pin
3	C _D	Pin for External Capacitor (for setting output delay)
4	OUT	Output Pin ("L" at detection)

ABSOLUTE MAXIMUM RATINGS

Symbol	Item	Rating	Unit
V_{DD}	Supply Voltage	7.0	V
V_{OUT}	Output Voltage (Nch Open Drain Output)	$V_{SS}-0.3$ to 7.0	V
	Output Voltage (CMOS Output)	$V_{SS}-0.3$ to $V_{DD}+0.3$	
I_{OUT}	Output Current	20	mA
P_D	Power Dissipation (SOT-23-5)*	420	mW
	Power Dissipation (SC-82AB)*	380	
	Power Dissipation (DFN(PLP)1010-4)*	400	
T_{opt}	Operating Temperature Range	-40 to 85	°C
T_{stg}	Storage Temperature Range	-55 to 125	°C

* Please refer to *PACKAGE INFORMATION* for detailed information.

ABSOLUTE MAXIMUM RATINGS

Electronic and mechanical stress momentarily exceeded absolute maximum ratings may cause the permanent damages and may degrade the life time and safety for both device and system using the device in the field. The functional operation at or over these absolute maximum ratings is not assured.

RECOMMENDED OPERATING CONDITIONS (ELECTRICAL CHARACTERISTICS)

All of electronic equipment should be designed that the mounted semiconductor devices operate within the recommended operating conditions. The semiconductor devices cannot operate normally over the recommended operating conditions, even if when they are used over such conditions by momentary electronic noise or surge. And the semiconductor devices may receive serious damage when they continue to operate over the recommended operating conditions.

ELECTRICAL CHARACTERISTICS

- R3116xxx1A/C values indicate $-40^{\circ}\text{C} \leq T_{\text{opt}} \leq 85^{\circ}\text{C}$, unless otherwise noted. (T_{opt}=25°C)

Symbol	Item	Conditions		Min.	Typ.	Max.	Unit	
-V _{DET}	Detector Threshold	T _{opt} =25°C	1.5V < -V _{DET} ≤ 5.0V	-V _{DET} × 0.992		-V _{DET} × 1.008	V	
			0.7V ≤ -V _{DET} ≤ 1.5V	-12		+12	mV	
		-40°C ≤ T _{opt} ≤ 85°C	1.5V < -V _{DET} ≤ 5.0V	-V _{DET} × 0.985		-V _{DET} × 1.015	V	
			0.7V ≤ -V _{DET} ≤ 1.5V	-22.5		+22.5	mV	
V _{HYS}	Detector Threshold Hysteresis			-V _{DET} × 0.04		-V _{DET} × 0.07	V	
I _{SS}	Supply Current	V _{DD} =-V _{DET} -0.1V	0.7V ≤ -V _{DET} < 1.6V			1.400	μA	
			1.6V ≤ -V _{DET} < 3.1V			1.500		
			3.1V ≤ -V _{DET} < 4.1V			1.600		
			4.1V ≤ -V _{DET} ≤ 5.0V			1.700		
		V _{DD} =-V _{DET} +1.0V	0.7V ≤ -V _{DET} < 1.6V			1.200		
			1.6V ≤ -V _{DET} < 3.1V			1.200		
			3.1V ≤ -V _{DET} < 4.1V			1.300		
			4.1V ≤ -V _{DET} ≤ 5.0V			1.400		
V _{DDH}	Maximum Operating Voltage					6	V	
V _{DDL}	Minimum Operating Voltage*1	T _{opt} =25°C				0.50	V	
		-40°C ≤ T _{opt} ≤ 85°C				0.55		
I _{OUT}	Output Current (Driver Output Pin)	Nch	V _{DD} =0.55V, V _{DS} =0.05V				7	μA
			0.7V ≤ -V _{DET} < 1.1V	V _{DD} =0.6V, V _{DS} =0.5V			0.020	mA
			1.1V ≤ -V _{DET} < 1.6V	V _{DD} =1.0V, V _{DS} =0.5V			0.400	
			1.6V ≤ -V _{DET} < 3.1V	V _{DD} =1.5V, V _{DS} =0.5V			1.000	
			3.1V ≤ -V _{DET} ≤ 5.0V	V _{DD} =3.0V, V _{DS} =0.5V			2.400	
		Pch*2	0.7V ≤ -V _{DET} < 4.0V	V _{DD} =4.5V, V _{DS} =-2.1V			0.650	mA
			4.0V ≤ -V _{DET} ≤ 5.0V	V _{DD} =6.0V, V _{DS} =-2.1V			0.900	
I _{LEAK}	Nch Driver Leakage Current*3	V _{DD} =6.0V, V _{DS} =7.0V				80	nA	
Δ-V _{DET} / ΔT _{opt}	Detector Threshold Temperature Coefficient				±30		ppm/°C	
t _o	Output Delay Time	C _D =0.022μF V _{DD} =-V _{DET} -0.1V to -V _{DET} × 1.1V	T _{opt} =25°C	0.7V ≤ -V _{DET} < 1.5V	80	100	130	ms
				1.5V ≤ -V _{DET} ≤ 5.0V	85		115	
			-40°C ≤ T _{opt} ≤ 85°C	0.7V ≤ -V _{DET} < 1.5V	70	100	150	
				1.5V ≤ -V _{DET} ≤ 5.0V	75		135	

All of unit are tested and specified under load conditions such that T_{opt}=25°C except for Detector Threshold Temperature Coefficient.

*1: Minimum operating voltage means the value of input voltage when output voltage maintains 0.1V or less.
(In case of Nch Open Drain Output type, the output pin is pulled up with a resistance of 470kΩ to 5.0V)

*2: In case of CMOS type

*3: In case of Nch Open Drain type

TIMING CHART



When the supply voltage, which is higher than released voltage, is forced to V_{DD} pin, charge to an external capacitor starts, then C_D pin voltage increases. Until the C_D pin voltage reaches to C_D pin threshold voltage, output voltage maintains "L". When the C_D pin voltage becomes higher than C_D pin threshold voltage, output voltage is reversed from "L" to "H". Where the time interval between the rising edge of supply voltage and output voltage reverse point means output delay time.

When the output voltage reverses from "L" to "H", the external capacitor starts to discharge. Therefore, when lower voltage than the detector threshold voltage is forced to V_{DD} pin, the output voltage reverses from "H" to "L" thus the detect delay time is constant not being affected by the external capacitor.

• Output Delay Time

Output Delay Time (t_b) can be calculated with the next formula using the external capacitor:

$$t_b(s) = 4.5 \times 10^6 \times C_D(F)$$

DEFINITION OF OUTPUT DELAY TIME

Output Delay Time (t_b) is defined as follows:

1. In the case of Nch Open Drain Output:

Under the condition of the output pin (OUT) is pulled up through a resistor of 470kΩ to 5V, the time interval between the rising edge of V_{DD} pulse from (-V_{DET})-0.1V to (-V_{DET})×1.1V pulse voltage is supplied, the becoming of the output voltage to 2.5V.

2. In the case of CMOS Output:

The time interval between the rising edge of V_{DD} pulse from (-V_{DET})-0.1V to (-V_{DET})×1.1V pulse voltage is supplied, the becoming of the output voltage to ((-V_{DET})×1.1V)/2.

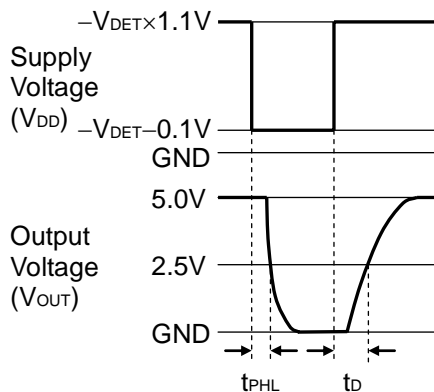

**Nch Open Drain Output
(R3116xxx1A)**

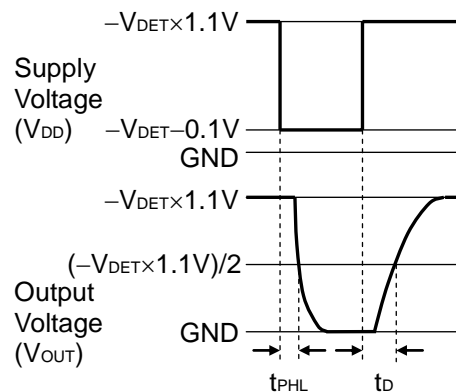

**CMOS Output
(R3116xxx1C)**

ELECTRICAL CHARACTERISTICS BY DETECTOR THRESHOLD

• R3116x071A/C to R3116x501A/C

Bold values are checked and guaranteed by design engineering at $-40^{\circ}\text{C} \leq T_{\text{opt}} \leq 85^{\circ}\text{C}$, unless otherwise noted.

($T_{\text{opt}}=25^{\circ}\text{C}$)

Part Number	Detector Threshold1		Detector Threshold2		Detector Threshold Hysteresis		Supply Current1		Supply Current2		Max. Op. Voltage	Min. Op. Voltage
	-V _{DET1} [V]		-V _{DET2} [V]		V _{HYS} [V]		I _{SS1} [μA]		I _{SS2} [μA]		V _{DDH} [V]	V _{DDL} [V]
	Min.	Max.	Min.	Max.	Min.	Max.	Cond.	Max.	Cond.	Max.	Max.	Max.
R3116x071A/C	0.688	0.712	0.678	0.723	0.028	0.049	V _{DD} = -V _{DET} -0.1V	1.400				0.50
R3116x081A/C	0.788	0.812	0.778	0.823	0.032	0.056						
R3116x091A/C	0.888	0.912	0.878	0.923	0.036	0.063						
R3116x101A/C	0.988	1.012	0.978	1.023	0.040	0.070						
R3116x111A/C	1.088	1.112	1.078	1.123	0.044	0.077						
R3116x121A/C	1.188	1.212	1.178	1.223	0.048	0.084						
R3116x131A/C	1.288	1.312	1.278	1.323	0.052	0.091						
R3116x141A/C	1.388	1.412	1.378	1.423	0.056	0.098						
R3116x151A/C	1.488	1.512	1.478	1.523	0.060	0.105						
R3116x161A/C	1.587	1.613	1.576	1.624	0.064	0.112						
R3116x171A/C	1.686	1.714	1.675	1.726	0.068	0.119						
R3116x181A/C	1.786	1.814	1.773	1.827	0.072	0.126						
R3116x191A/C	1.885	1.915	1.872	1.929	0.076	0.133						
R3116x201A/C	1.984	2.016	1.970	2.030	0.080	0.140						
R3116x211A/C	2.083	2.117	2.069	2.132	0.084	0.147						
R3116x221A/C	2.182	2.218	2.167	2.233	0.088	0.154						
R3116x231A/C	2.282	2.318	2.266	2.335	0.092	0.161						
R3116x241A/C	2.381	2.419	2.364	2.436	0.096	0.168						
R3116x251A/C	2.480	2.520	2.463	2.538	0.100	0.175						
R3116x261A/C	2.579	2.621	2.561	2.639	0.104	0.182						
R3116x271A/C	2.678	2.722	2.660	2.741	0.108	0.189						
R3116x281A/C	2.778	2.822	2.758	2.842	0.112	0.196						
R3116x291A/C	2.877	2.923	2.857	2.944	0.116	0.203						
R3116x301A/C	2.976	3.024	2.955	3.045	0.120	0.210						
R3116x311A/C	3.075	3.125	3.054	3.147	0.124	0.217						
R3116x321A/C	3.174	3.226	3.152	3.248	0.128	0.224						
R3116x331A/C	3.274	3.326	3.251	3.350	0.132	0.231						
R3116x341A/C	3.373	3.427	3.349	3.451	0.136	0.238						
R3116x351A/C	3.472	3.528	3.448	3.553	0.140	0.245						
R3116x361A/C	3.571	3.629	3.546	3.654	0.144	0.252						
R3116x371A/C	3.670	3.730	3.645	3.756	0.148	0.259						
R3116x381A/C	3.770	3.830	3.743	3.857	0.152	0.266						
R3116x391A/C	3.869	3.931	3.842	3.959	0.156	0.273						
R3116x401A/C	3.968	4.032	3.940	4.060	0.160	0.280						
R3116x411A/C	4.067	4.133	4.039	4.162	0.164	0.287						
R3116x421A/C	4.166	4.234	4.137	4.263	0.168	0.294						
R3116x431A/C	4.266	4.334	4.236	4.365	0.172	0.301						
R3116x441A/C	4.365	4.435	4.334	4.466	0.176	0.308						
R3116x451A/C	4.464	4.536	4.433	4.568	0.180	0.315						
R3116x461A/C	4.563	4.637	4.531	4.669	0.184	0.322						
R3116x471A/C	4.662	4.738	4.630	4.771	0.188	0.329						
R3116x481A/C	4.762	4.838	4.728	4.872	0.192	0.336						
R3116x491A/C	4.861	4.939	4.827	4.974	0.196	0.343						
R3116x501A/C	4.960	5.040	4.925	5.075	0.200	0.350						

*Note1) V_{DD} value when output voltage is equal or less than 0.1V. In the case of Nch Open Drain output type, the output pin is pulled up to 5.0V through 470kΩ resistor.

R3116x

NO.EA-161-140819

Nch Driver Output Current1		Nch Driver Output Current2		Pch Driver Output Current		Nch Driver Leakage Current		Detector Threshold Temperature Coefficient	Output Delay Time		
IOUT1 [μA]		IOUT2 [mA]		IOUT3 [mA]		ILEAK [nA]		$\Delta-V_{DET}/\Delta T_{opt}$ [ppm/°C]	td [ms]		
Cond.	Min.	Cond.	Min.	Cond.	Min.	Cond.	Max.	Typ.	Cond.	Min.	Max.
V _{DD} = 0.55V V _{DS} = 0.05V	7	V _{DD} = 0.6V V _{DS} = 0.5V	0.020	V _{DD} = 4.5V V _{DS} = -2.1V	0.650	V _{DD} = 6.0V V _{DS} = 7.0V	80	±30	C _D = 0.022μF V _{DD} = -V _{DET} -0.1V ↓ -V _{DET} ×1.1V *Note2	80	130
		V _{DD} = 1.0V V _{DS} = 0.5V	0.400							70	150
		V _{DD} = 1.5V V _{DS} = 0.5V	1.000							85	115
		V _{DD} = 3.0V V _{DS} = 0.5V	2.400							75	135
		V _{DD} = 6.0V V _{DS} = -2.1V	0.900								

*Note2) 1. In the case of CMOS output type:
When the voltage is forced from (-V_{DET})-0.1V to (-V_{DET})×1.1V pulse voltage is added to V_{DD}, time interval that the output voltage reaches ((-V_{DET})×1.1V)/2.

2. In the case of Nch Open Drain output type:
The output pin is pulled up to 5.0V through 470kΩ, and when the voltage is forced from (-V_{DET})-0.1V to (-V_{DET})×1.1V pulse voltage is added to V_{DD}, time interval that the output voltage reaches 2.5V.

TYPICAL APPLICATION

• R3116xxx1A CPU Reset Circuit 1 (Nch Open Drain Output)

Case1. Input Voltage to R3116xxx1A is equal to Input Voltage to CPU

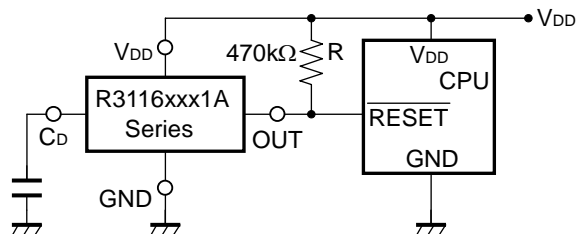

Case2. Input Voltage to R3116xxx1A is unequal to Input Voltage to CPU

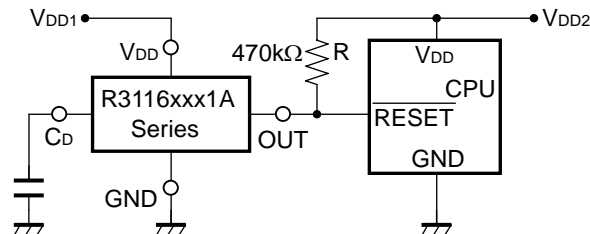

• R3116xxx1C CPU Reset Circuit 2 (CMOS Output)

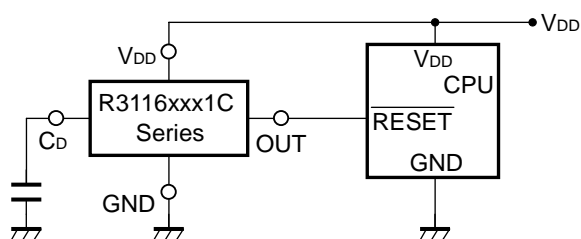

• Memory Back-up Circuit

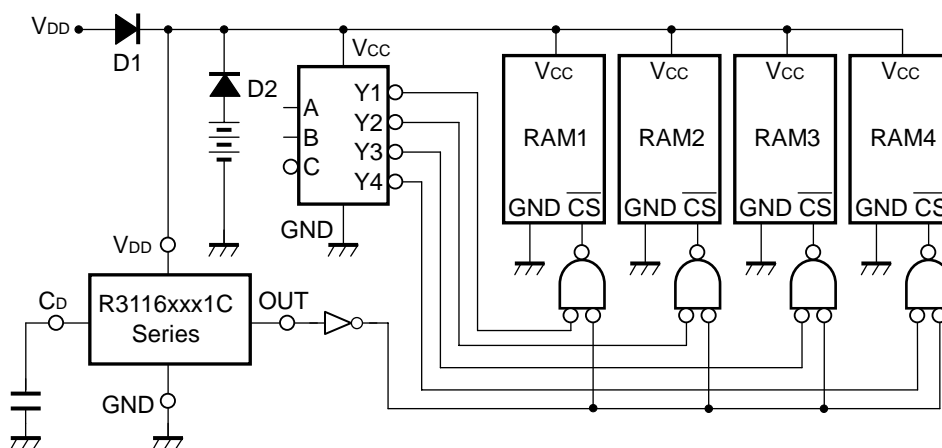

R3116x

NO.EA-161-140819

- **Voltage level Indicator Circuit (lighted when the power runs out)
(Nch Open Drain Output)**



- **Detector Threshold Adjustable Circuit 1
(Nch Open Drain Output)**

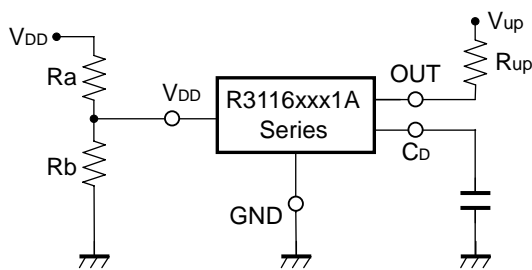

Adjustable Detector Threshold= $(-V_{DET}) \times (Ra+Rb)/Rb$

Hysteresis Voltage= $(V_{HYS}) \times (Ra+Rb)/Rb$

- *1) To prevent oscillation, set $Ra \leq 1k\Omega$, $Rb \leq 100\Omega$.
- *2) If the value of Ra is set excessively large, voltage drop may occur caused by the supply current of IC itself, and detector threshold and hysteresis voltage may vary.
- *3) If Vup and VDD are connected, the voltage dropdown caused by Rup, may cause difference in the hysteresis voltage.

- **Detector Threshold Adjustable Circuit 2
(Nch Open Drain Output)**

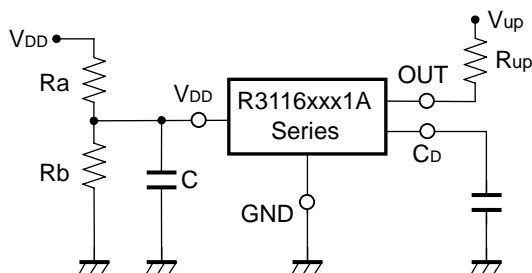

Adjustable Detector Threshold= $(-V_{DET}) \times (Ra+Rb)/Rb$

Hysteresis Voltage= $(V_{HYS}) \times (Ra+Rb)/Rb$

- *1) To prevent oscillation, set $Ra \leq 10k\Omega$, $Rb \leq 1k\Omega$, $C \geq 1\mu F$.
- *2) If the value of Ra is set excessively large, voltage drop may occur caused by the supply current of IC itself, and detector threshold and hysteresis voltage may vary.
- *3) If Vup and VDD are connected, the voltage dropdown caused by Rup, may cause difference in the hysteresis voltage.
- *4) If the value of Ra, Rb and C are set excessively large, the delay of the start-up may become too long.

• **Window Comparator Circuit
(Nch Open Drain Output)**

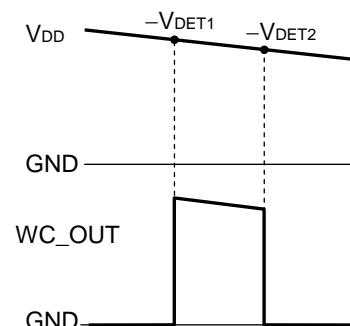

• **Over-charge Preventing Circuit**

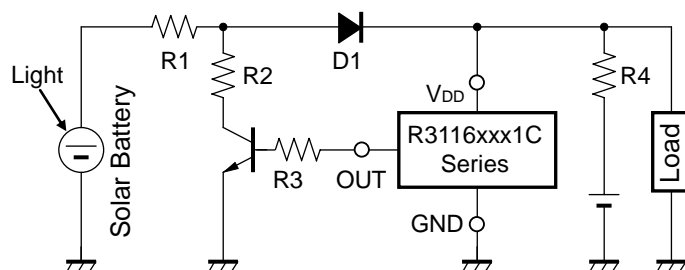

TECHNICAL NOTES

When connecting resistors to the device's input pin

When connecting a resistor (R1) to an input of this device, the input voltage decreases by [Device's Consumption Current] x [Resistance Value] only. And, the cross conduction current*¹, which occurs when changing from the detecting state to the release state, is decreased the input voltage by [Cross Conduction Current] x [Resistance Value] only. And then, this device will enter the re-detecting state if the input voltage reduction is larger than the difference between the detector voltage and the released voltage.

When the input resistance value is large and the VDD is gone up at mildly in the vicinity of the released voltage, repeating the above operation may result in the occurrence of output.

As shown in Figure A/B, set R1 to become 100kΩ or less as a guide, and connect C_{IN} of 0.1μF and more to between the input pin and GND. Besides, make evaluations including temperature properties under the actual usage condition, with using the evaluation board like this way. As result, make sure that the cross conduction current has no problem.



Figure A

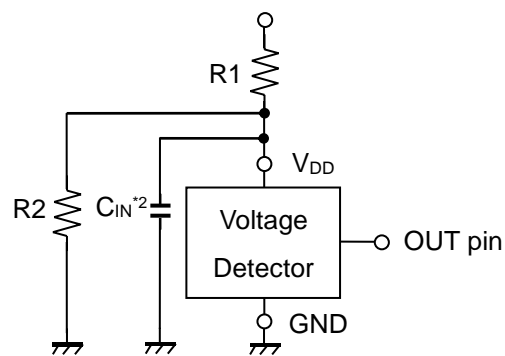

Figure B

*¹ In the CMOS output type, a charging current for OUT pin is included.

*² Note the bias dependence of capacitors.

OPERATION

• Operation of R3116xxx1A

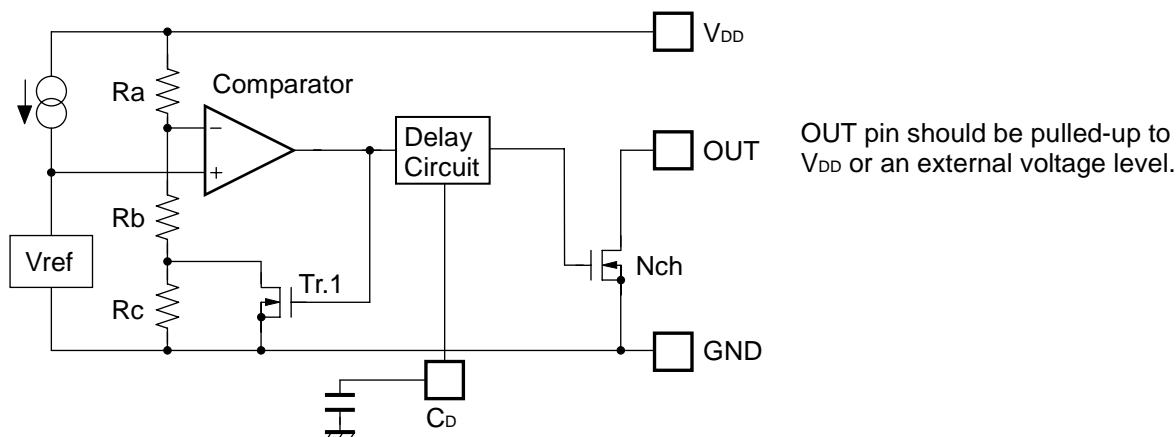

Block Diagram (R3116xxx1A)

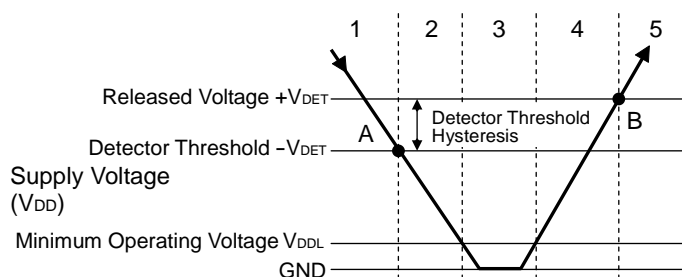

Step	1	2	3	4	5
Comparator (-) Pin Input Voltage	I	II	II	II	I
Comparator Output	L	H	Indefinite	H	L
Tr.1	OFF	ON	Indefinite	ON	OFF
Output Tr. Nch	OFF	ON	Indefinite	ON	OFF

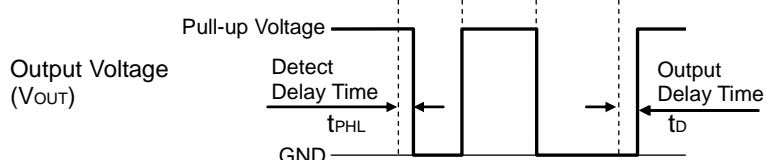

Operation Diagram

$$I \quad \frac{R_b + R_c}{R_a + R_b + R_c} \times V_{DD}$$

$$II \quad \frac{R_b}{R_a + R_b} \times V_{DD}$$

• Explanation of operation

Step 1. The output voltage is equal to the pull-up voltage.

Step 2. At Point "A", $V_{ref} \geq V_{DD} \times (R_b + R_c) / (R_a + R_b + R_c)$ is true, as a result, the output of comparator is reversed from "L" to "H", therefore the output voltage becomes the GND level. The voltage level of Point A means a detector threshold voltage ($-V_{DET}$).

Step 3. When the supply voltage is lower than the minimum operating voltage, the operation of the output transistor becomes indefinite. The output voltage is equal to the pull-up voltage.

Step 4. The output voltage is equal to the GND level.

Step 5. At Point "B", $V_{ref} \leq V_{DD} \times R_b / (R_a + R_b)$ is true, as a result, the output of comparator is reversed from "H" to "L", then the output voltage is equal to the pull-up voltage. The voltage level of Point B means a released voltage ($+V_{DET}$).

*) The difference between a released voltage and a detector threshold voltage is a detector threshold hysteresis.

• Operation of R3116xxx1C



Block Diagram (R3116xxx1C)

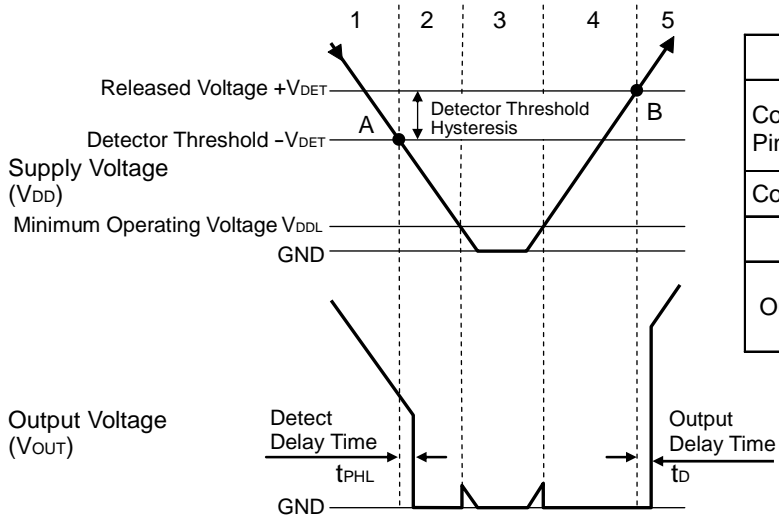

Step	1	2	3	4	5	
Comparator (-) Pin Input Voltage	I	II	II	II	I	
Comparator Output	L	H	Indefinite	H	L	
Tr.1	OFF	ON	Indefinite	ON	OFF	
Output Tr.	Pch	ON	OFF	Indefinite	OFF	ON
	Nch	OFF	ON	Indefinite	ON	OFF

$$I \quad \frac{Rb+Rc}{Ra+Rb+Rc} \times V_{DD}$$

$$II \quad \frac{Rb}{Ra+Rb} \times V_{DD}$$

Operation Diagram

• Explanation of operation

- Step 1. The output voltage is equal to the supply voltage (V_{DD}).
- Step 2. At Point "A", $V_{ref} \geq V_{DD} \times (Rb+Rc) / (Ra+Rb+Rc)$ is true, as a result, the output of comparator is reversed from "L" to "H", therefore the output voltage becomes the GND level. The voltage level of Point A means a detector threshold voltage ($-V_{DET}$).
- Step 3. When the supply voltage is lower than the minimum operating voltage, the operation of the output transistor becomes indefinite.
- Step 4. The output voltage is equal to the GND level.
- Step 5. At Point "B", $V_{ref} \leq V_{DD} \times Rb / (Ra+Rb)$ is true, as a result, the output of comparator is reversed from "H" to "L", then the output voltage is equal to the supply voltage (V_{DD}). The voltage level of Point B means a released voltage ($+V_{DET}$).

*) The difference between a released voltage and a detector threshold voltage is a detector threshold hysteresis.

Detector Operation vs. glitch input voltage to the V_{DD} pin

When the R3116x is at released, if the pulse voltage which the detector threshold or lower voltage, the graph below means that the relation between pulse width and the amplitude of the swing to keep the released state for the R3116x.



V_{DD} Input Waveform

This graph shows the maximum pulse conditions to keep the released voltage. If the pulse with larger amplitude or wider width than the graph above, is input to V_{DD} pin, the reset signal may be output.

PACKAGE INFORMATION

POWER DISSIPATION (DFN(PLP)1010-4)

Power Dissipation (P_D) depends on conditions of mounting on board. This specification is based on the measurement at the condition below:

Measurement Conditions

	Standard Test Land Pattern
Environment	Mounting on Board (Wind velocity=0m/s)
Board Material	Glass cloth epoxy plastic (Double sided)
Board Dimensions	40mm*40mm*1.6mm
Copper Ratio	Top side: Approx. 50%, Back side: Approx. 50%
Through-holes	ϕ 0.54mm * 24pcs

Measurement Result:

($T_a=25^\circ\text{C}$, $T_{j\text{max}}=125^\circ\text{C}$)

	Standard Test Land Pattern
Power Dissipation	400mW
Thermal Resistance	$\theta_{ja} = (125-25^\circ\text{C})/0.4\text{W} = 250^\circ\text{C/W}$
	$\theta_{jc} = 67^\circ\text{C/W}$

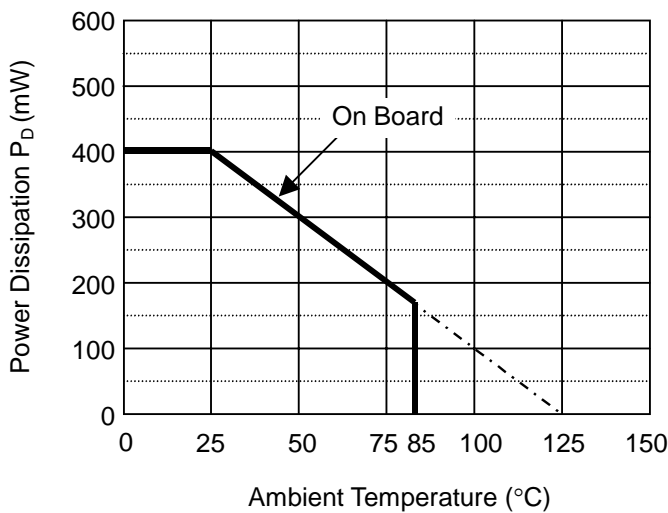

Power Dissipation

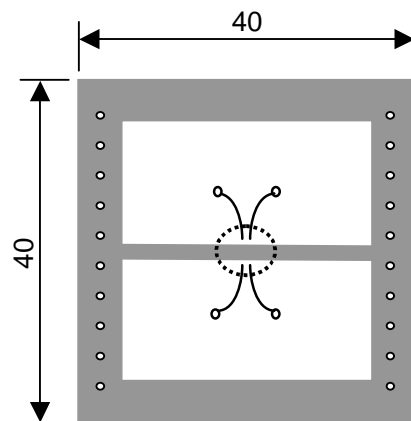

Measurement Board Pattern

 IC Mount Area (Unit : mm)

PACKAGE DIMENSIONS (DFN(PLP)1010-4)

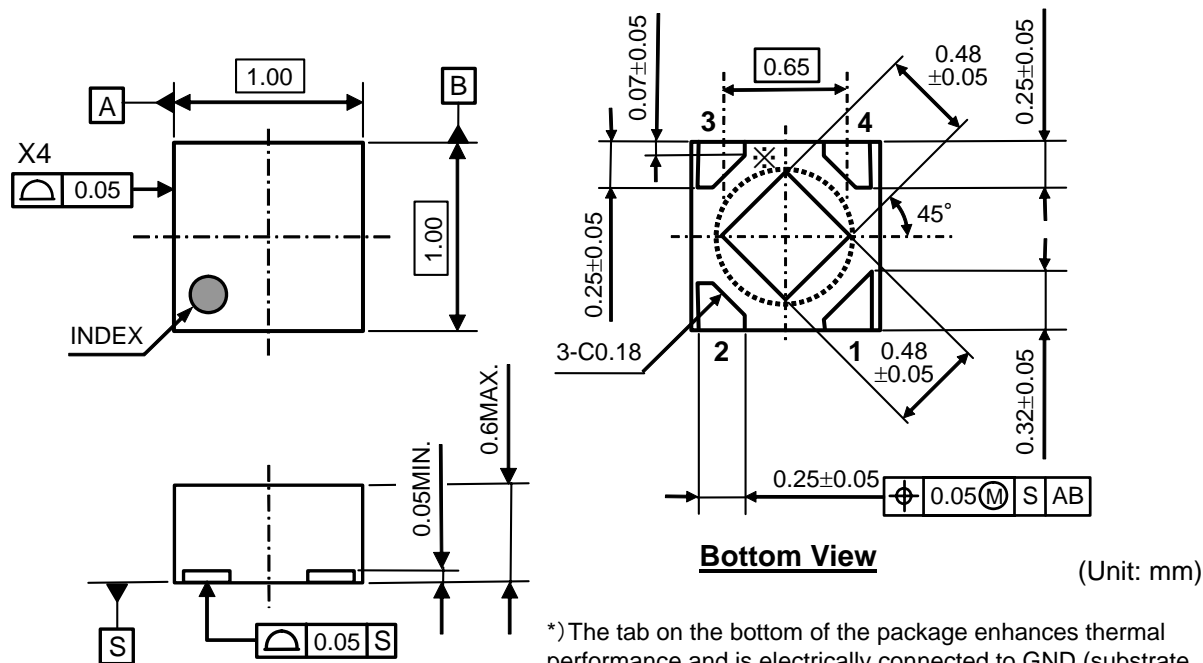

*) The tab on the bottom of the package enhances thermal performance and is electrically connected to GND (substrate level). It is recommended that the tab be connected to the ground plane on the board, or otherwise be left floating.

MARK SPECIFICATION (DFN(PLP)1010-4)

①②: Product Code ... **Refer to MARK SPECIFICATION TABLE**

③④: Lot Number ... Alphanumeric Serial Number

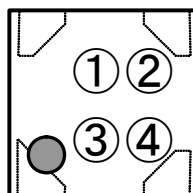

R3116x

NO.EA-161-140819

MARK SPECIFICATION TABLE (DFN(PLP)1010-4)**R3116Kxx1A**

Product Name	①②	V _{SET}
R3116K071A	HA	0.7V
R3116K081A	HB	0.8V
R3116K091A	HC	0.9V
R3116K101A	HD	1.0V
R3116K111A	HE	1.1V
R3116K121A	HF	1.2V
R3116K131A	HG	1.3V
R3116K141A	HH	1.4V
R3116K151A	HJ	1.5V
R3116K161A	HK	1.6V
R3116K171A	HL	1.7V
R3116K181A	HM	1.8V
R3116K191A	HN	1.9V
R3116K201A	HP	2.0V
R3116K211A	HQ	2.1V
R3116K221A	HR	2.2V
R3116K231A	HS	2.3V
R3116K241A	HT	2.4V
R3116K251A	HU	2.5V
R3116K261A	HV	2.6V
R3116K271A	HW	2.7V
R3116K281A	HX	2.8V
R3116K291A	HY	2.9V
R3116K301A	HZ	3.0V
R3116K311A	JA	3.1V
R3116K321A	JB	3.2V
R3116K331A	JC	3.3V
R3116K341A	JD	3.4V
R3116K351A	JE	3.5V
R3116K361A	JF	3.6V
R3116K371A	JG	3.7V
R3116K381A	JH	3.8V
R3116K391A	JJ	3.9V
R3116K401A	JK	4.0V
R3116K411A	JL	4.1V
R3116K421A	JM	4.2V
R3116K431A	JN	4.3V
R3116K441A	JP	4.4V
R3116K451A	JQ	4.5V
R3116K461A	JR	4.6V
R3116K471A	JS	4.7V
R3116K481A	JT	4.8V
R3116K491A	JU	4.9V
R3116K501A	JV	5.0V

R3116Kxx1C

Product Name	①②	V _{SET}
R3116K071C	KA	0.7V
R3116K081C	KB	0.8V
R3116K091C	KC	0.9V
R3116K101C	KD	1.0V
R3116K111C	KE	1.1V
R3116K121C	KF	1.2V
R3116K131C	KG	1.3V
R3116K141C	KH	1.4V
R3116K151C	KJ	1.5V
R3116K161C	KK	1.6V
R3116K171C	KL	1.7V
R3116K181C	KM	1.8V
R3116K191C	KN	1.9V
R3116K201C	KP	2.0V
R3116K211C	KQ	2.1V
R3116K221C	KR	2.2V
R3116K231C	KS	2.3V
R3116K241C	KT	2.4V
R3116K251C	KU	2.5V
R3116K261C	KV	2.6V
R3116K271C	KW	2.7V
R3116K281C	KX	2.8V
R3116K291C	KY	2.9V
R3116K301C	KZ	3.0V
R3116K311C	LA	3.1V
R3116K321C	LB	3.2V
R3116K331C	LC	3.3V
R3116K341C	LD	3.4V
R3116K351C	LE	3.5V
R3116K361C	LF	3.6V
R3116K371C	LG	3.7V
R3116K381C	LH	3.8V
R3116K391C	LJ	3.9V
R3116K401C	LK	4.0V
R3116K411C	LL	4.1V
R3116K421C	LM	4.2V
R3116K431C	LN	4.3V
R3116K441C	LP	4.4V
R3116K451C	LQ	4.5V
R3116K461C	LR	4.6V
R3116K471C	LS	4.7V
R3116K481C	LT	4.8V
R3116K491C	LU	4.9V
R3116K501C	LV	5.0V

POWER DISSIPATION (SC-82AB)

Power Dissipation (P_D) depends on conditions of mounting on board. This specification is based on the measurement at the condition below;

* Measurement Conditions

	Standard Land Pattern
Environment	Mounting on Board (Wind velocity=0m/s)
Board Material	Glass cloth epoxy plastic (Double Layers)
Board Dimensions	40mm × 40mm × 1.6mm
Copper Ratio	Top side: Approx. 50%, Back side: Approx. 50%
Through-hole	φ0.5mm × 44pcs

* Measurement Result

(Ta=25°C, Tjmax=125°C)

	Standard Land Pattern	Free Air
Power Dissipation	380mW	150mW
Thermal Resistance	$\theta_{ja} = (125-25^\circ\text{C})/0.38\text{W} = 263^\circ\text{C/W}$	667°C/W

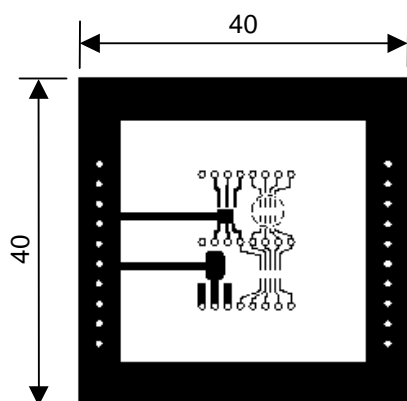
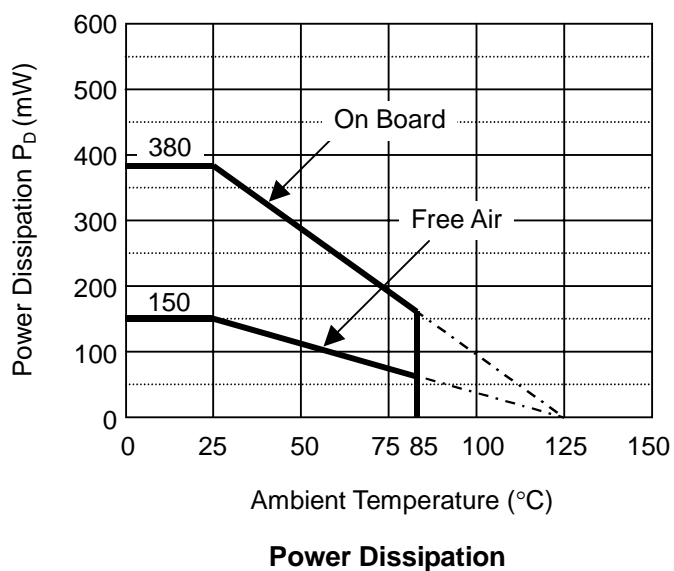
**Measurement Board Pattern**

○ IC Mount Area (Unit : mm)

R3116x

NO.EA-161-140819

PACKAGE DIMENSIONS (SC-82AB)

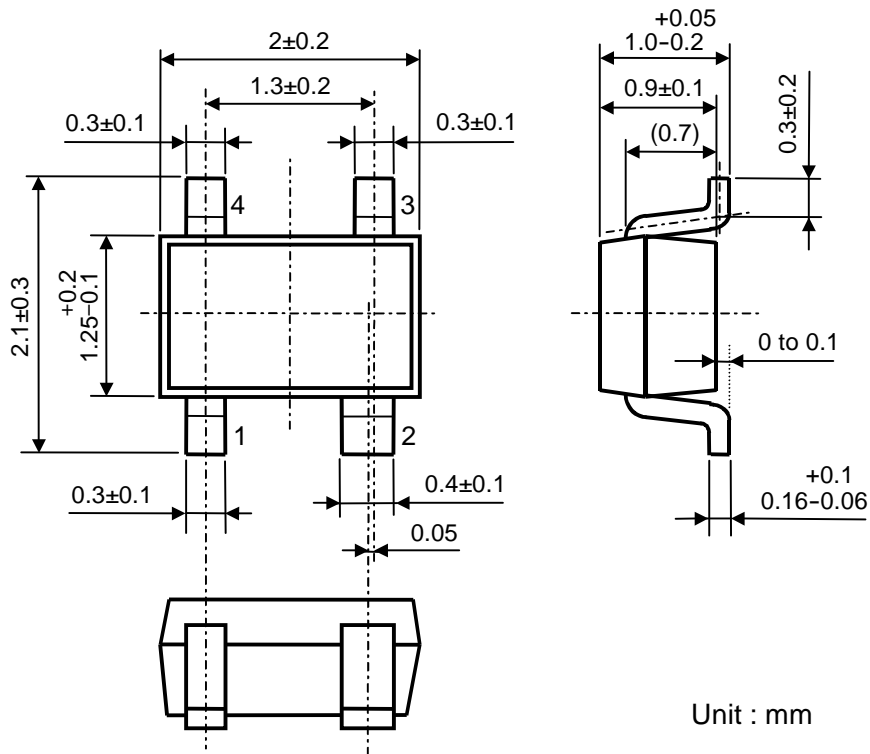

MARK SPECIFICATION (SC-82AB)

①②: Product Code ... Refer to MARK SPECIFICATION TABLE

③④: Lot Number ... Alphanumeric Serial Number

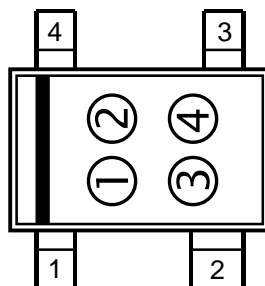

MARK SPECIFICATION TABLE (SC-82AB)

R3116Qxx1A

Product Name	① ②	V _{SET}
R3116Q071A	L 0	0.7V
R3116Q081A	L 1	0.8V
R3116Q091A	L 2	0.9V
R3116Q101A	L 3	1.0V
R3116Q111A	L 4	1.1V
R3116Q121A	L 5	1.2V
R3116Q131A	L 6	1.3V
R3116Q141A	L 7	1.4V
R3116Q151A	L 8	1.5V
R3116Q161A	L 9	1.6V
R3116Q171A	M 0	1.7V
R3116Q181A	M 1	1.8V
R3116Q191A	M 2	1.9V
R3116Q201A	M 3	2.0V
R3116Q211A	M 4	2.1V
R3116Q221A	M 5	2.2V
R3116Q231A	M 6	2.3V
R3116Q241A	M 7	2.4V
R3116Q251A	M 8	2.5V
R3116Q261A	M 9	2.6V
R3116Q271A	N 0	2.7V
R3116Q281A	N 1	2.8V
R3116Q291A	N 2	2.9V
R3116Q301A	N 3	3.0V
R3116Q311A	N 4	3.1V
R3116Q321A	N 5	3.2V
R3116Q331A	N 6	3.3V
R3116Q341A	N 7	3.4V
R3116Q351A	N 8	3.5V
R3116Q361A	N 9	3.6V
R3116Q371A	P 0	3.7V
R3116Q381A	P 1	3.8V
R3116Q391A	P 2	3.9V
R3116Q401A	P 3	4.0V
R3116Q411A	P 4	4.1V
R3116Q421A	P 5	4.2V
R3116Q431A	P 6	4.3V
R3116Q441A	P 7	4.4V
R3116Q451A	P 8	4.5V
R3116Q461A	P 9	4.6V
R3116Q471A	Q 0	4.7V
R3116Q481A	Q 1	4.8V
R3116Q491A	Q 2	4.9V
R3116Q501A	Q 3	5.0V

R3116Qxx1C

Product Name	① ②	V _{SET}
R3116Q071C	R 0	0.7V
R3116Q081C	R 1	0.8V
R3116Q091C	R 2	0.9V
R3116Q101C	R 3	1.0V
R3116Q111C	R 4	1.1V
R3116Q121C	R 5	1.2V
R3116Q131C	R 6	1.3V
R3116Q141C	R 7	1.4V
R3116Q151C	R 8	1.5V
R3116Q161C	R 9	1.6V
R3116Q171C	S 0	1.7V
R3116Q181C	S 1	1.8V
R3116Q191C	S 2	1.9V
R3116Q201C	S 3	2.0V
R3116Q211C	S 4	2.1V
R3116Q221C	S 5	2.2V
R3116Q231C	S 6	2.3V
R3116Q241C	S 7	2.4V
R3116Q251C	S 8	2.5V
R3116Q261C	S 9	2.6V
R3116Q271C	T 0	2.7V
R3116Q281C	T 1	2.8V
R3116Q291C	T 2	2.9V
R3116Q301C	T 3	3.0V
R3116Q311C	T 4	3.1V
R3116Q321C	T 5	3.2V
R3116Q331C	T 6	3.3V
R3116Q341C	T 7	3.4V
R3116Q351C	T 8	3.5V
R3116Q361C	T 9	3.6V
R3116Q371C	U 0	3.7V
R3116Q381C	U 1	3.8V
R3116Q391C	U 2	3.9V
R3116Q401C	U 3	4.0V
R3116Q411C	U 4	4.1V
R3116Q421C	U 5	4.2V
R3116Q431C	U 6	4.3V
R3116Q441C	U 7	4.4V
R3116Q451C	U 8	4.5V
R3116Q461C	U 9	4.6V
R3116Q471C	V 0	4.7V
R3116Q481C	V 1	4.8V
R3116Q491C	V 2	4.9V
R3116Q501C	V 3	5.0V

R3116x

NO.EA-161-140819

POWER DISSIPATION (SOT-23-5)

Power Dissipation (P_D) depends on conditions of mounting on board. This specification is based on the measurement at the condition below:

(Power Dissipation (SOT-23-5) is substitution of SOT-23-6.)

* Measurement Conditions

	Standard Test Land Pattern
Environment	Mounting on Board (Wind velocity=0m/s)
Board Material	Glass cloth epoxy plastic (Double sided)
Board Dimensions	40mm*40mm*1.6mm
Copper Ratio	Top side: Approx. 50%, Back side: Approx. 50%
Through-holes	ϕ 0.5mm * 44pcs

* Measurement Result: (Ta=25°C, Tjmax=125°C)

	Standard Land Pattern	Free Air
Power Dissipation	420mW	250mW
Thermal Resistance	$\theta_{ja} = (125-25^\circ\text{C})/0.42\text{W} = 238^\circ\text{C/W}$	400°C/W



Power Dissipation



Measurement Board Pattern

○ IC Mount Area (Unit: mm)

PACKAGE DIMENSIONS (SOT-23-5)



MARK SPECIFICATION (SOT-23-5)

①②③: Product Code ... **Refer to MARK SPECIFICATION TABLE**

④⑤: Lot Number ... Alphanumeric Serial Number



R3116x

NO.EA-161-140819

MARK SPECIFICATION TABLE (SOT-23-5)**R3116Nxx1A**

Product Name	①②③	V _{SET}
R3116N071A	D 0 A	0.7V
R3116N081A	D 0 B	0.8V
R3116N091A	D 0 C	0.9V
R3116N101A	D 0 D	1.0V
R3116N111A	D 0 E	1.1V
R3116N121A	D 0 F	1.2V
R3116N131A	D 0 G	1.3V
R3116N141A	D 0 H	1.4V
R3116N151A	D 0 J	1.5V
R3116N161A	D 0 K	1.6V
R3116N171A	D 0 L	1.7V
R3116N181A	D 0 M	1.8V
R3116N191A	D 0 N	1.9V
R3116N201A	D 0 P	2.0V
R3116N211A	D 0 Q	2.1V
R3116N221A	D 0 R	2.2V
R3116N231A	D 0 S	2.3V
R3116N241A	D 0 T	2.4V
R3116N251A	D 0 U	2.5V
R3116N261A	D 0 V	2.6V
R3116N271A	D 0 W	2.7V
R3116N281A	D 0 X	2.8V
R3116N291A	D 0 Y	2.9V
R3116N301A	D 0 Z	3.0V
R3116N311A	E 0 A	3.1V
R3116N321A	E 0 B	3.2V
R3116N331A	E 0 C	3.3V
R3116N341A	E 0 D	3.4V
R3116N351A	E 0 E	3.5V
R3116N361A	E 0 F	3.6V
R3116N371A	E 0 G	3.7V
R3116N381A	E 0 H	3.8V
R3116N391A	E 0 J	3.9V
R3116N401A	E 0 K	4.0V
R3116N411A	E 0 L	4.1V
R3116N421A	E 0 M	4.2V
R3116N431A	E 0 N	4.3V
R3116N441A	E 0 P	4.4V
R3116N451A	E 0 Q	4.5V
R3116N461A	E 0 R	4.6V
R3116N471A	E 0 S	4.7V
R3116N481A	E 0 T	4.8V
R3116N491A	E 0 U	4.9V
R3116N501A	E 0 V	5.0V

R3116Nxx1C

Product Name	①②③	V _{SET}
R3116N071C	D 1 A	0.7V
R3116N081C	D 1 B	0.8V
R3116N091C	D 1 C	0.9V
R3116N101C	D 1 D	1.0V
R3116N111C	D 1 E	1.1V
R3116N121C	D 1 F	1.2V
R3116N131C	D 1 G	1.3V
R3116N141C	D 1 H	1.4V
R3116N151C	D 1 J	1.5V
R3116N161C	D 1 K	1.6V
R3116N171C	D 1 L	1.7V
R3116N181C	D 1 M	1.8V
R3116N191C	D 1 N	1.9V
R3116N201C	D 1 P	2.0V
R3116N211C	D 1 Q	2.1V
R3116N221C	D 1 R	2.2V
R3116N231C	D 1 S	2.3V
R3116N241C	D 1 T	2.4V
R3116N251C	D 1 U	2.5V
R3116N261C	D 1 V	2.6V
R3116N271C	D 1 W	2.7V
R3116N281C	D 1 X	2.8V
R3116N291C	D 1 Y	2.9V
R3116N301C	D 1 Z	3.0V
R3116N311C	E 1 A	3.1V
R3116N321C	E 1 B	3.2V
R3116N331C	E 1 C	3.3V
R3116N341C	E 1 D	3.4V
R3116N351C	E 1 E	3.5V
R3116N361C	E 1 F	3.6V
R3116N371C	E 1 G	3.7V
R3116N381C	E 1 H	3.8V
R3116N391C	E 1 J	3.9V
R3116N401C	E 1 K	4.0V
R3116N411C	E 1 L	4.1V
R3116N421C	E 1 M	4.2V
R3116N431C	E 1 N	4.3V
R3116N441C	E 1 P	4.4V
R3116N451C	E 1 Q	4.5V
R3116N461C	E 1 R	4.6V
R3116N471C	E 1 S	4.7V
R3116N481C	E 1 T	4.8V
R3116N491C	E 1 U	4.9V
R3116N501C	E 1 V	5.0V

TYPICAL CHARACTERISTICS

Note: Typical Characteristics are intended to be used as reference data; they are not guaranteed.

1) Supply Current vs. Input Voltage

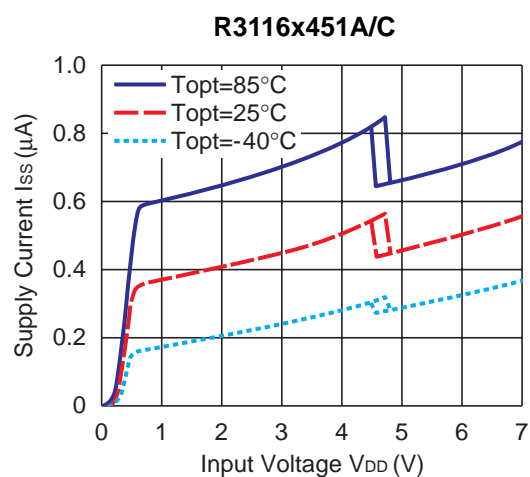
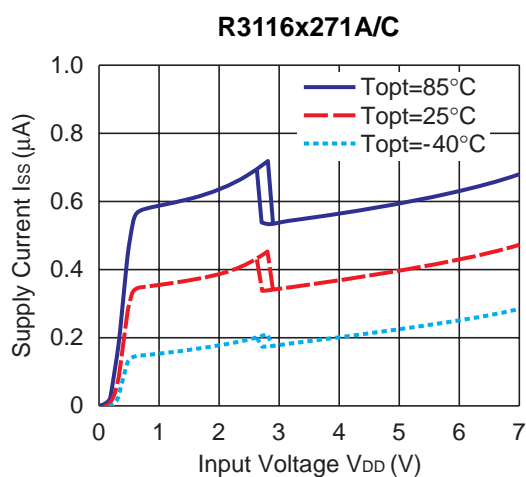
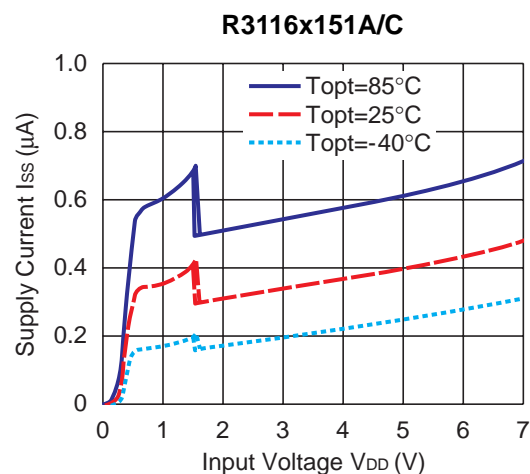
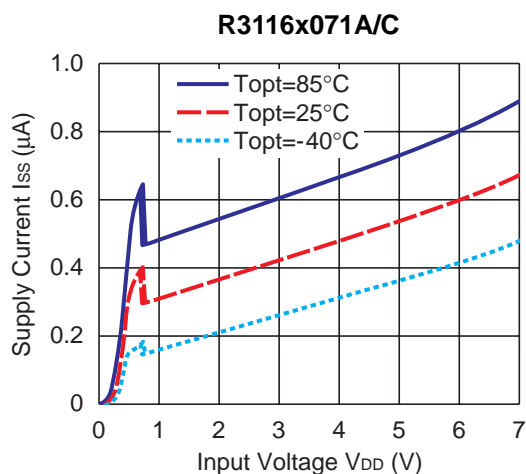

2) Detector Threshold vs. Temperature

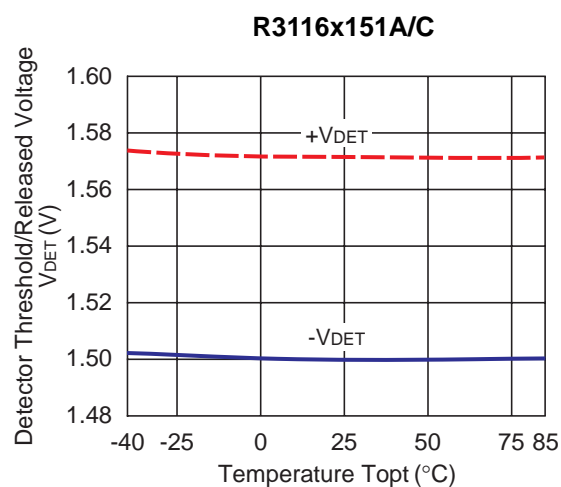
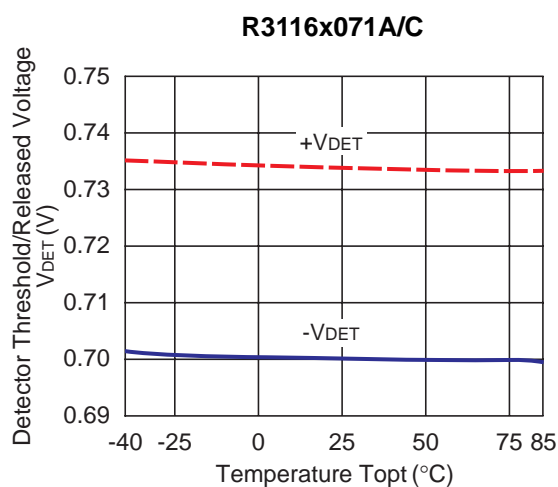

R3116x

NO.EA-161-140819

R3116x271A/C



R3116x451A/C



3) Output Voltage vs. Input Voltage

R3116x071C

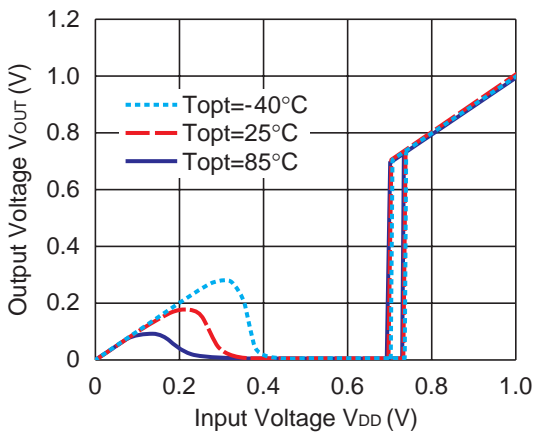

R3116x151C

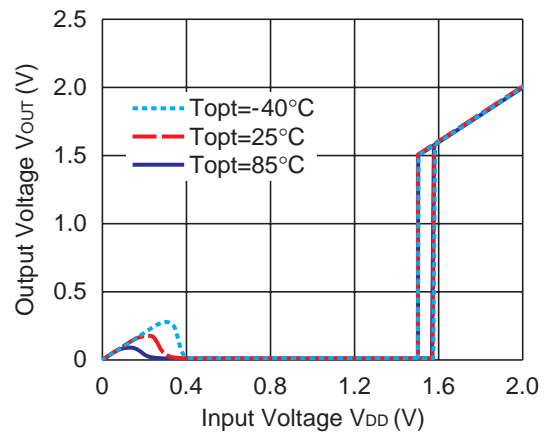

R3116x271C

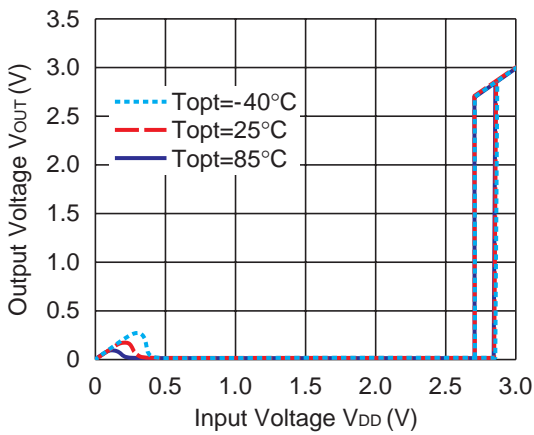

R3116x451C

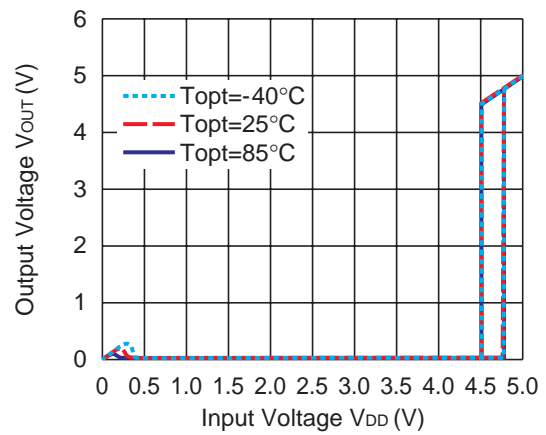



4) Nch Driver Output Current vs. Input Voltage ($V_{ds}=0.5V$)

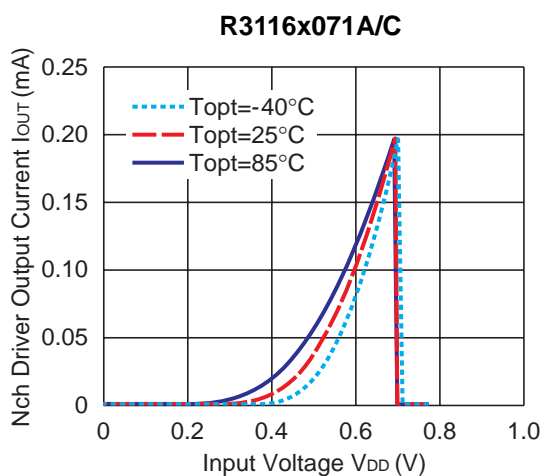

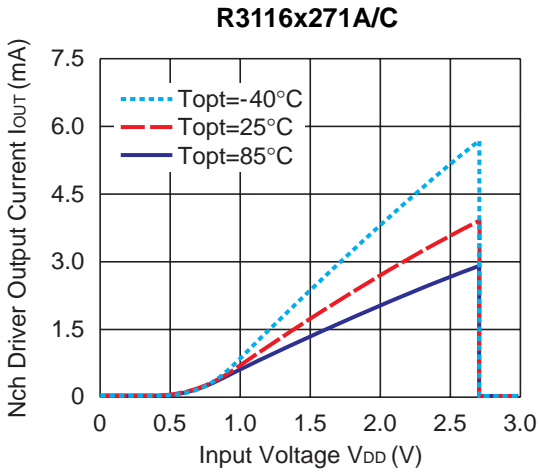

5) Nch Driver Output Current vs. V_{DS}

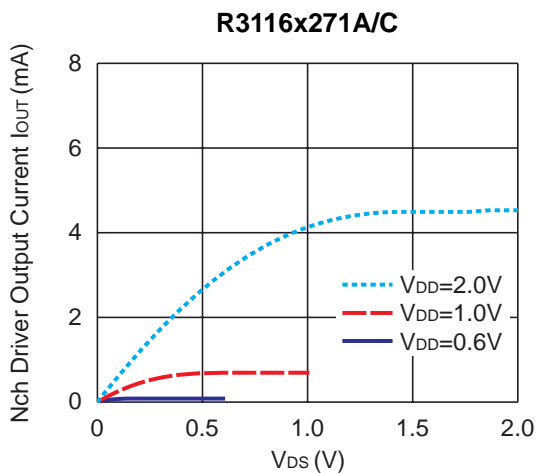
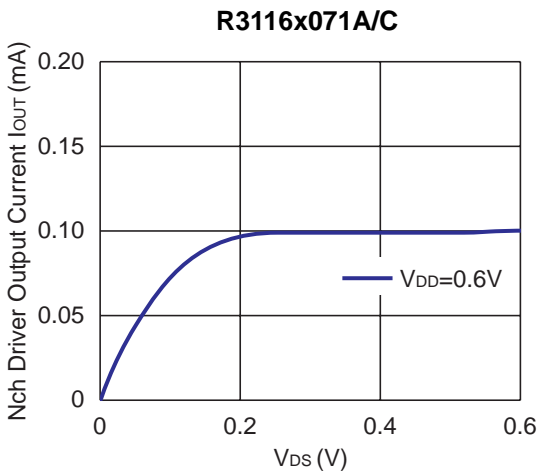

6) Pch Driver Output Current vs. Input Voltage ($V_{DS} = -2.1V$)

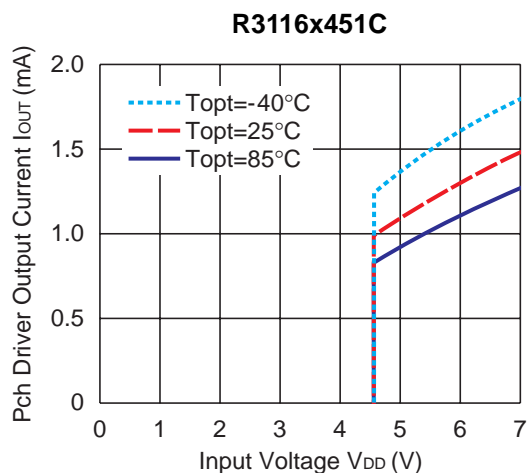
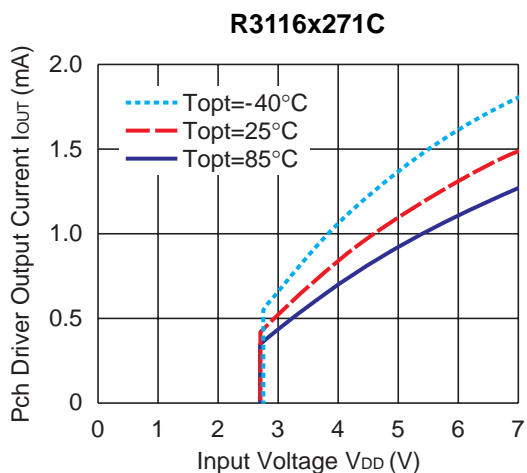
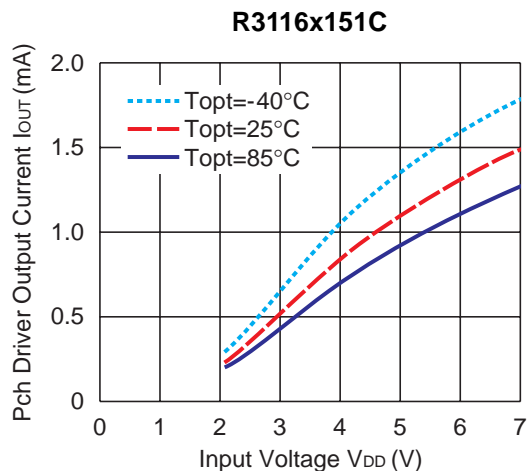
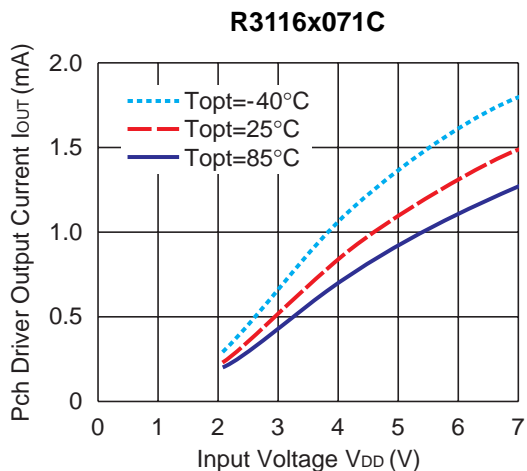

7) Pch Driver Output Current vs. V_{DS}

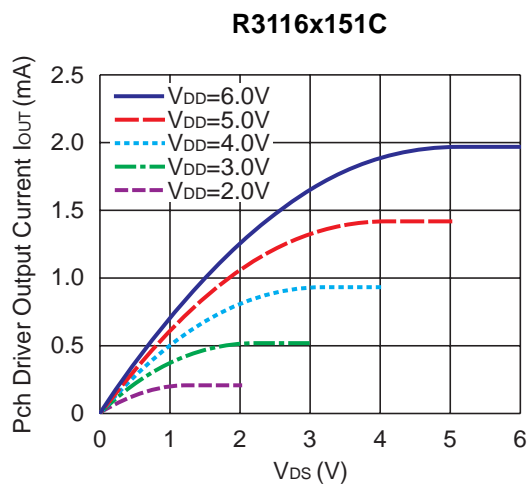
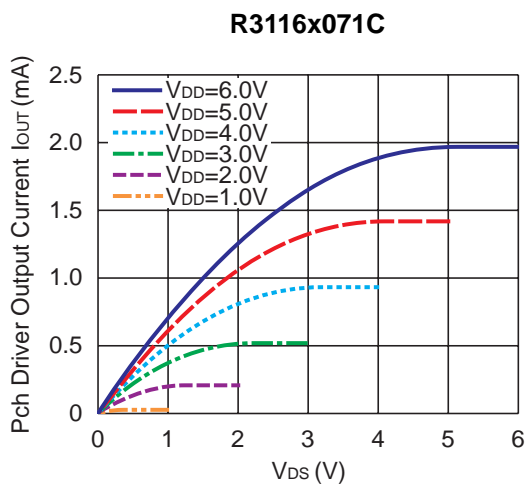

R3116x

NO.EA-161-140819

R3116x271C



R3116x451C



8) Output Delay Time vs. External Capacitance

R3116x071A/C



R3116x151A/C



R3116x271A/C



R3116x451A/C



9) Output Delay Time vs. Temperature ($C_D=22nF$)

R3116x071A/C

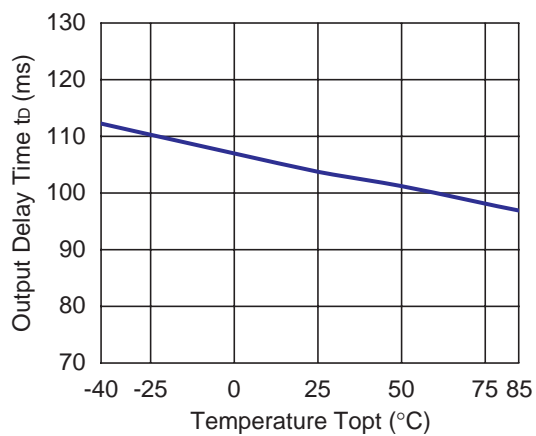

R3116x151A/C

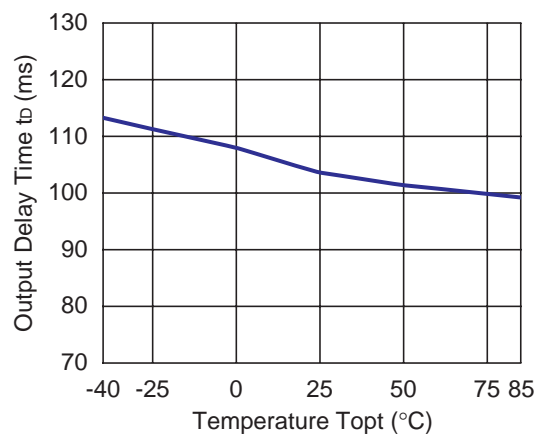

R3116x271A/C

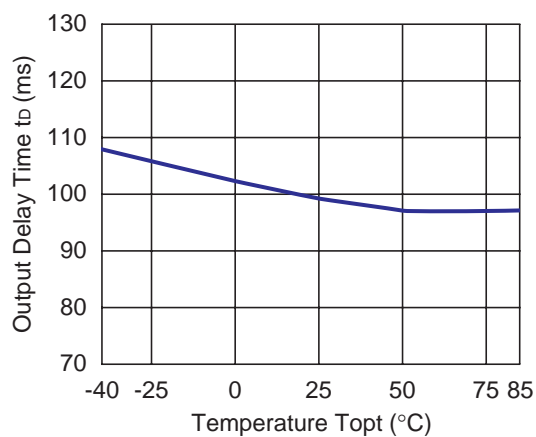

R3116x451A/C

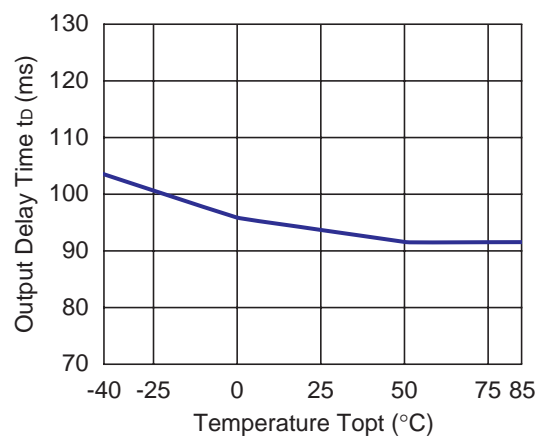



1. The products and the product specifications described in this document are subject to change or discontinuation of production without notice for reasons such as improvement. Therefore, before deciding to use the products, please refer to Ricoh sales representatives for the latest information thereon.
2. The materials in this document may not be copied or otherwise reproduced in whole or in part without prior written consent of Ricoh.
3. Please be sure to take any necessary formalities under relevant laws or regulations before exporting or otherwise taking out of your country the products or the technical information described herein.
4. The technical information described in this document shows typical characteristics of and example application circuits for the products. The release of such information is not to be construed as a warranty of or a grant of license under Ricoh's or any third party's intellectual property rights or any other rights.
5. The products listed in this document are intended and designed for use as general electronic components in standard applications (office equipment, telecommunication equipment, measuring instruments, consumer electronic products, amusement equipment etc.). Those customers intending to use a product in an application requiring extreme quality and reliability, for example, in a highly specific application where the failure or misoperation of the product could result in human injury or death (aircraft, spacevehicle, nuclear reactor control system, traffic control system, automotive and transportation equipment, combustion equipment, safety devices, life support system etc.) should first contact us.
6. We are making our continuous effort to improve the quality and reliability of our products, but semiconductor products are likely to fail with certain probability. In order to prevent any injury to persons or damages to property resulting from such failure, customers should be careful enough to incorporate safety measures in their design, such as redundancy feature, fire containment feature and fail-safe feature. We do not assume any liability or responsibility for any loss or damage arising from misuse or inappropriate use of the products.
7. Anti-radiation design is not implemented in the products described in this document.
8. Please contact Ricoh sales representatives should you have any questions or comments concerning the products or the technical information.



Ricoh is committed to reducing the environmental loading materials in electrical devices with a view to contributing to the protection of human health and the environment.

Ricoh has been providing RoHS compliant products since April 1, 2006 and Halogen-free products since April 1, 2012.

RICOH RICOH ELECTRONIC DEVICES CO., LTD.

<http://www.e-devices.ricoh.co.jp/en/>

Sales & Support Offices

RICOH ELECTRONIC DEVICES CO., LTD.

Higashi-Shinagawa Office (International Sales)
3-32-3, Higashi-Shinagawa, Shinagawa-ku, Tokyo 140-8655, Japan
Phone: +81-3-5479-2857 Fax: +81-3-5479-0502

RICOH EUROPE (NETHERLANDS) B.V.

Semiconductor Support Centre
Prof. W.H. Keesomlaan 1, 1183 DJ Amstelveen, The Netherlands
Phone: +31-20-5474-309

RICOH ELECTRONIC DEVICES KOREA CO., LTD.

3F, Haesung Bldg. 504, Teheran-ro, Gangnam-gu, Seoul, 135-725, Korea
Phone: +82-2-2135-5700 Fax: +82-2-2051-5713

RICOH ELECTRONIC DEVICES SHANGHAI CO., LTD.

Room 403, No.2 Building, No.690 Bilbo Road, Pu Dong New District, Shanghai 201203,
People's Republic of China
Phone: +86-21-5027-3200 Fax: +86-21-5027-3299

RICOH ELECTRONIC DEVICES CO., LTD.

Taipei office
Room 109, 10F-1, No.51, Hengyang Rd., Taipei City, Taiwan (R.O.C.)
Phone: +886-2-2313-1621/1622 Fax: +886-2-2313-1623

Mouser Electronics

Authorized Distributor

Click to View Pricing, Inventory, Delivery & Lifecycle Information:

Ricoh Electronics:

[R3116K301C-TR](#) [R3116K251A-TR](#) [R3116K271A-TR](#) [R3116N071C-TR-FE](#) [R3116N151C-TR-FE](#) [R3116K421A-TR](#)
[R3116N151A-TR-FE](#) [R3116N281C-TR-FE](#) [R3116K181A-TR](#) [R3116Q401C-TR-FE](#) [R3116Q081A-TR-FE](#)
[R3116Q271A-TR-FE](#) [R3116K321A-TR](#) [R3116Q301A-TR-FE](#) [R3116K121A-TR](#) [R3116K271C-TR](#) [R3116K291A-TR](#)
[R3116K311A-TR](#) [R3116Q421C-TR-FE](#) [R3116K301A-TR](#) [R3116N271C-TR-FE](#) [R3116N431A-TR-FE](#) [R3116Q171A-](#)
[TR-FE](#) [R3116Q201C-TR-FE](#) [R3116Q191A-TR-FE](#) [R3116N101C-TR-FE](#) [R3116K151C-TR](#) [R3116Q101A-TR-FE](#)
[R3116K221A-TR](#) [R3116Q231A-TR-FE](#) [R3116Q311C-TR-FE](#) [R3116N081C-TR-FE](#) [R3116N401A-TR-FE](#)
[R3116N071A-TR-FE](#) [R3116K161A-TR](#) [R3116Q151C-TR-FE](#) [R3116N091A-TR-FE](#) [R3116Q251C-TR-FE](#)
[R3116N201A-TR-FE](#) [R3116N221A-TR-FE](#) [R3116K211A-TR](#) [R3116Q421A-TR-FE](#) [R3116N191A-TR-FE](#)
[R3116Q401A-TR-FE](#) [R3116K281A-TR](#) [R3116N211A-TR-FE](#) [R3116K221C-TR](#) [R3116K381A-TR](#)

Компания «Океан Электроники» предлагает заключение долгосрочных отношений при поставках импортных электронных компонентов на взаимовыгодных условиях!

Наши преимущества:

- Поставка оригинальных импортных электронных компонентов напрямую с производств Америки, Европы и Азии, а так же с крупнейших складов мира;
- Широкая линейка поставок активных и пассивных импортных электронных компонентов (более 30 млн. наименований);
- Поставка сложных, дефицитных, либо снятых с производства позиций;
- Оперативные сроки поставки под заказ (от 5 рабочих дней);
- Экспресс доставка в любую точку России;
- Помощь Конструкторского Отдела и консультации квалифицированных инженеров;
- Техническая поддержка проекта, помощь в подборе аналогов, поставка прототипов;
- Поставка электронных компонентов под контролем ВП;
- Система менеджмента качества сертифицирована по Международному стандарту ISO 9001;
- При необходимости вся продукция военного и аэрокосмического назначения проходит испытания и сертификацию в лаборатории (по согласованию с заказчиком);
- Поставка специализированных компонентов военного и аэрокосмического уровня качества (Xilinx, Altera, Analog Devices, Intersil, Interpoint, Microsemi, Actel, Aeroflex, Peregrine, VPT, Syfer, Eurofarad, Texas Instruments, MS Kennedy, Miteq, Cobham, E2V, MA-COM, Hittite, Mini-Circuits, General Dynamics и др.);

Компания «Океан Электроники» является официальным дистрибьютором и эксклюзивным представителем в России одного из крупнейших производителей разъемов военного и аэрокосмического назначения «JONHON», а так же официальным дистрибьютором и эксклюзивным представителем в России производителя высокотехнологичных и надежных решений для передачи СВЧ сигналов «FORSTAR».



JONHON

«JONHON» (основан в 1970 г.)

Разъемы специального, военного и аэрокосмического назначения:

(Применяются в военной, авиационной, аэрокосмической, морской, железнодорожной, горно- и нефтедобывающей отраслях промышленности)

«FORSTAR» (основан в 1998 г.)

ВЧ соединители, коаксиальные кабели, кабельные сборки и микроволновые компоненты:

(Применяются в телекоммуникациях гражданского и специального назначения, в средствах связи, РЛС, а так же военной, авиационной и аэрокосмической отраслях промышленности).



Телефон: 8 (812) 309-75-97 (многоканальный)

Факс: 8 (812) 320-03-32

Электронная почта: ocean@oceanchips.ru

Web: <http://oceanchips.ru/>

Адрес: 198099, г. Санкт-Петербург, ул. Калинина, д. 2, корп. 4, лит. А