

## **NTC thermistors for temperature measurement**

SMD NTC thermistors,  
case size 0805 (2012), automotive series

**Series/Type:** B574\*\*V5  
**Date:** December 2016

© EPCOS AG 2016. Reproduction, publication and dissemination of this publication, enclosures hereto and the information contained therein without EPCOS' prior express consent is prohibited.

EPCOS AG is a TDK Group Company.

### SMD

#### Applications

- Temperature measurement and compensation

#### Features

- Qualification based on AEC-Q200 Rev-D
- Multilayer SMD NTC with inner electrodes
- Nickel barrier termination
- For temperature measurement up to 150 °C
- Excellent long-term aging stability in high temperature and high humidity environment
- UL approval (E69802)

#### Options

- Alternative resistance ratings, resistance tolerances and B value tolerances available on request.

#### Delivery mode

Cardboard tape, 180-mm reel

#### General technical data

Operating temperature range		$T_{op}$	-40 ... 150	°C
Max. power	(at 25 °C, on PCB)	$P_{25}^{(1)}$	210	mW
Resistance tolerance		$\Delta R_R/R_R$	$\pm 3, \pm 5$	%
Rated temperature		$T_R$	25	°C
Dissipation factor	(on PCB)	$\delta_{th}^{(1)}$	approx. 3.5	mW/K
Thermal cooling time constant	(on PCB)	$\tau_c^{(1)}$	approx. 10	s
Heat capacity		$C_{th}^{(1)}$	approx. 35	mJ/K

#### Electrical specification and ordering codes

$R_{25}$ Ω	$\Delta R_R/R_R$ %	No. of R/T characteristic	$B_{25/50}$ K	$B_{25/85}$ K	$B_{25/100}$ K	Ordering code
4.7 k	$\pm 3, \pm 5$	8500	3590	3635	3650 $\pm 3\%$	B57442V5472+062
4.7 k	$\pm 3, \pm 5$	8507	4386	4455	4480 $\pm 3\%$	B57452V5472+062
10 k	$\pm 3, \pm 5$	8500	3590	3635	3650 $\pm 3\%$	B57442V5103+062
10 k	$\pm 3, \pm 5$	8502	3940	3980	4000 $\pm 3\%$	B57451V5103+062
10 k	$\pm 3, \pm 5$	8507	4386	4455	4480 $\pm 3\%$	B57452V5103+062
33 k	$\pm 3, \pm 5$	8502	3940	3980	4000 $\pm 3\%$	B57451V5333+062
47 k	$\pm 3, \pm 5$	8502	3940	3980	4000 $\pm 3\%$	B57451V5473+062
100 k	$\pm 3, \pm 5$	8507	4386	4455	4480 $\pm 3\%$	B57452V5104+062

+ = Resistance tolerance

H =  $\pm 3\%$

J =  $\pm 5\%$

1) Depends on mounting situation

#### Dimensional drawing

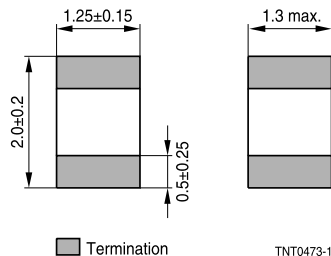

Dimensions in mm  
Approx. weight 13 mg

**SMD**
**Reliability data**

Tests of SMD NTC thermistors are based on AEC-Q200 Rev-D. The parts are mounted on standardized PCB.

Test	Standard	Test conditions	$\Delta R_{25}/R_{25}$ (typical)	Remarks
Pre- and post-stress electrical test		Resistance at: 25 °C and 100 °C		
High temperature exposure (storage)	MIL-STD-202, method 108	Test temperature: 150 °C Duration: 1000 h Unpowered	< 5%	
Temperature cycling	JESD22, method JA-104	Lower test temperature: -40 °C Upper test temperature: 150 °C Number of cycles: 1000 Transfer time: < 10 s Dwell time: 15 min Air – Air	< 5%	
Biased humidity	MIL-STD-202, method 103	Test temperature: 85 °C Rel. humidity of air: 85% Duration: 1000 h Test voltage: $V_{NTC} = 0.3 \text{ V DC}$	< 5%	
Operational life	MIL-STD-202, method 108	Test temperature: 150 °C $P_{\max} = 0.35 \text{ mW}$ Duration: 1000 h	< 5%	
External visual	MIL-STD-883E, method 2009	Visual inspection		
Physical dimensions	JESD22, method JB-100	Measured with calipers		Within the specified values
Resistance to solvents	MIL-STD-202, method 215	Not applicable for SMD thermistors (component has no marking, color coding or coating)		
Mechanical shock	MIL-STD-202, method 213	Peak value: 1500 g Half sine Condition F	< 5%	
Vibration	MIL-STD-202, method 204	Acceleration: 5 g Sweep time: 20 min Frequency range: 10 ... 2000 Hz 3 × 12 cycles	< 5%	
Resistance to soldering heat	MIL-STD-202, method 210	Dip: 260 °C; 10 s 1 heat cycle	< 3%	

**SMD**

Test	Standard	Test conditions	$\Delta R_{25}/R_{25}$ (typical)	Remarks
ESD	AEC-Q200-002 method -002	Discharge capacitance: 150 pF Discharge resistance: 2 k $\Omega$ Charging voltage: 6 kV Contact discharge 2 pulses in each polarity	< 5%	
Solderability	J-STD-002	a) Dip: 235 °C; 5 s: aging 4 h @ 155 °C b) Dip: 215 °C; 5 s: steam aging 8 h @ 92 °C c) Dip: 260 °C; 7 s: steam aging 8 h @ 92 °C		95% of termination wetted
Electrical characterization		R(25 °C), R(100 °C), B(25/100)		Within the specified values
Flammability	UL-94, V-0 or V-1	Not applicable for SMD thermistors (component is not coated or encapsulated with plastic materials)		
Board flex	AEC-Q200-005 method -005	Max. bending: 2 mm Duration @ max. bending: 60 s	< 5%	
Terminal strength	AEC-Q200-006 method -006	Max. F: 17.7 N	< 5%	
Resistance drift after soldering		Reflow soldering profile Wave soldering profile	< 1%	

**SMD**
**R/T characteristics**

R/T No.	<b>8500</b>		<b>8502</b>		<b>8507</b>	
T (°C)	B <sub>25/100</sub> = 3650 K		B <sub>25/100</sub> = 4000 K		B <sub>25/100</sub> = 4480 K	
	R <sub>T</sub> /R <sub>25</sub>	α (%/K)	R <sub>T</sub> /R <sub>25</sub>	α (%/K)	R <sub>T</sub> /R <sub>25</sub>	α (%/K)
-55.0	63.917	6.8	96.158	7.4	142.71	7.9
-50.0	45.889	6.5	66.892	7.1	96.913	7.6
-45.0	33.344	6.3	47.127	6.9	66.637	7.4
-40.0	24.504	6.1	33.606	6.6	46.366	7.1
-35.0	18.201	5.8	24.243	6.4	32.629	6.9
-30.0	13.657	5.6	17.681	6.2	23.213	6.7
-25.0	10.347	5.5	13.032	6.0	16.686	6.5
-20.0	7.9114	5.3	9.702	5.8	12.115	6.3
-15.0	6.1019	5.1	7.2923	5.6	8.8803	6.1
-10.0	4.7454	4.9	5.5314	5.4	6.5692	5.9
-5.0	3.7198	4.8	4.2325	5.3	4.9025	5.8
0.0	2.938	4.6	3.2657	5.1	3.6896	5.6
5.0	2.3372	4.5	2.54	4.9	2.7994	5.4
10.0	1.8722	4.4	1.9907	4.8	2.1406	5.3
15.0	1.5096	4.2	1.5716	4.7	1.6492	5.1
20.0	1.2249	4.1	1.2494	4.5	1.2798	5.0
25.0	1.0000	4.0	1.0000	4.4	1.0000	4.9
30.0	0.82111	3.9	0.80552	4.3	0.78663	4.7
35.0	0.67798	3.8	0.65288	4.1	0.62277	4.6
40.0	0.56279	3.7	0.53229	4.0	0.4961	4.5
45.0	0.46958	3.6	0.43645	3.9	0.39757	4.4
50.0	0.39374	3.5	0.35981	3.8	0.32044	4.3
55.0	0.33171	3.4	0.29819	3.7	0.2597	4.1
60.0	0.28073	3.3	0.24837	3.6	0.21161	4.0
65.0	0.23863	3.2	0.20787	3.5	0.17331	3.9
70.0	0.2037	3.1	0.17479	3.4	0.14265	3.8
75.0	0.17459	3.0	0.14763	3.3	0.11799	3.8
80.0	0.15022	3.0	0.12523	3.2	0.098035	3.7
85.0	0.12975	2.9	0.10667	3.2	0.081823	3.6
90.0	0.11247	2.8	0.091227	3.1	0.068589	3.5
95.0	0.097838	2.8	0.078319	3.0	0.057735	3.4
100.0	0.085396	2.7	0.067488	2.9	0.048796	3.3
105.0	0.074781	2.6	0.058363	2.9	0.041403	3.2
110.0	0.065691	2.6	0.050647	2.8	0.035263	3.2
115.0	0.057883	2.5	0.044098	2.7	0.030143	3.1
120.0	0.051153	2.4	0.03852	2.7	0.025858	3.0
125.0	0.045335	2.4	0.033752	2.6	0.022258	3.0
130.0	0.040289	2.3	0.029663	2.6	0.019223	2.9
135.0	0.0359	2.3	0.026146	2.5	0.016655	2.8
140.0	0.032071	2.2	0.023111	2.4	0.014476	2.8
145.0	0.028723	2.2	0.020484	2.4	0.012619	2.7
150.0	0.025786	2.1	0.018203	2.3	0.011033	2.7

SMD
**Taping and packing**
**1 Taping of SMD NTC thermistors**

Tape and reel packing according to IEC 60286-3.

Tape material: Cardboard or blister, tape width  $8 \pm 0.30$  mm

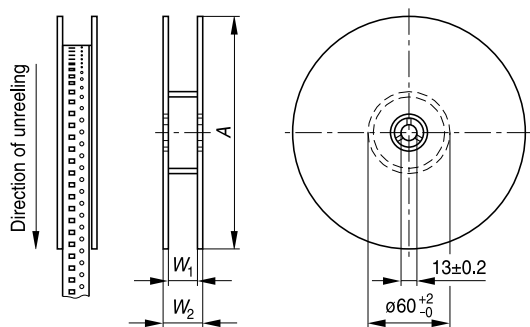
**2 Reel packing**

KKE0058-IE

**Dimensions in mm**

	8-mm tape	
	180-mm reel	330-mm reel
A	180 +0/-3	330 +0/-2.0
W <sub>1</sub>	8.4 +1.5/-0	8.4 +1.5/-0
W <sub>2</sub>	14.4 max.	14.4 max.

**SMD**
**Leader, trailer**

Trailer (tape end)

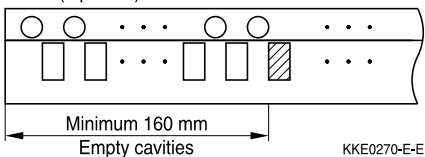

Leader

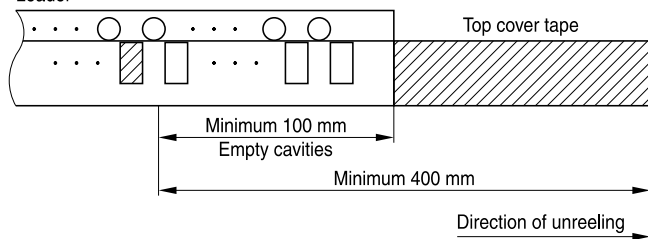
**Packing units for discrete chip**

Case size inch/mm	 Chip thickness th	 Cardboard tape		 Blister tape		 ∅ 180-mm reel pcs.	 ∅ 330-mm reel pcs.
		W	W	W	W		
0402/1005	0.5 mm	8 mm	—	—	—	10000	50000
0603/1608	0.8 mm	8 mm	8 mm	8 mm	8 mm	4000	16000
0805/2012	0.8 mm	—	8 mm	8 mm	8 mm	4000	16000
	1.2 mm	—	8 mm	8 mm	8 mm	3000	12000
1206/3216	0.8 mm	—	8 mm	8 mm	8 mm	3000	12000
	1.2 mm	—	8 mm	8 mm	8 mm	3000	12000

**3 Packing codes**

The last two digits of the complete ordering code state the packing mode:

Last two digits			
60	SMD	Cardboard tape	180-mm reel packing
62	SMD	Blister tape	180-mm reel packing
70	SMD	Cardboard tape	330-mm reel packing
72	SMD	Blister tape	330-mm reel packing

## SMD

### Mounting instructions

#### 1 Soldering

##### 1.1 SMD NTC thermistors

SMD NTC thermistors can be provided with a nickel barrier termination or on special request with silver-palladium termination. The usage of mild, non-activated fluxes for soldering is recommended as well as a proper cleaning of the PCB.

The nickel barrier layer of the silver/nickel/tin termination (see figure 1) prevents leaching of the silver base metalization layer. This allows great flexibility in the selection of soldering parameters.

The tin prevents the nickel layer from oxidizing and thus ensures better wetting by the solder. The nickel barrier termination is suitable for all commonly-used soldering methods.

**Note:** SMD NTCs with AgPd termination are not approved for lead-free soldering.

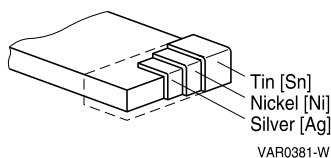

Figure 1

SMD NTC thermistors, structure of nickel barrier termination



SMD

**1.2 Wave soldering**

Temperature characteristic at component terminal with dual wave soldering

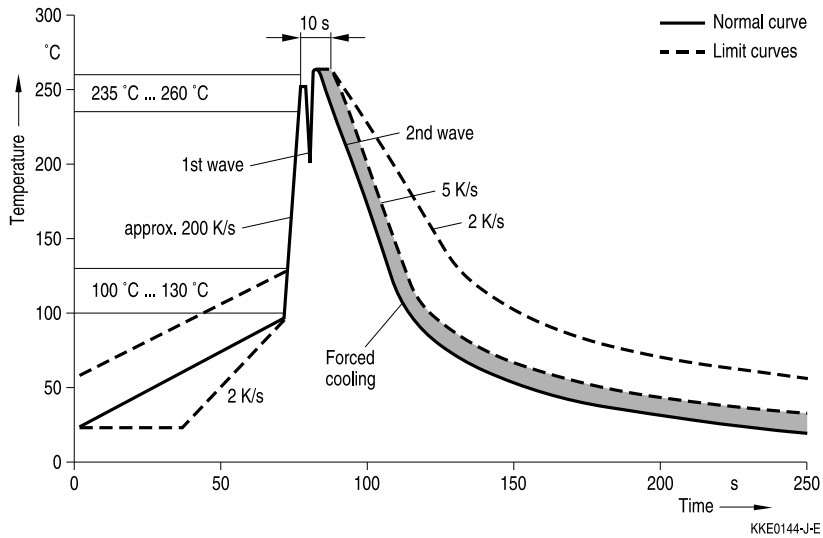

Solder joint profiles for silver/nickel/tin terminations

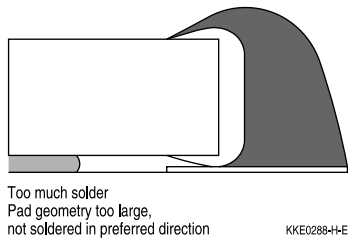
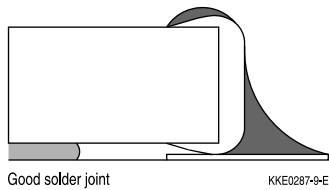

**SMD**
**1.3 Reflow soldering**

Recommended temperature characteristic for reflow soldering following JEDEC J-STD-020D

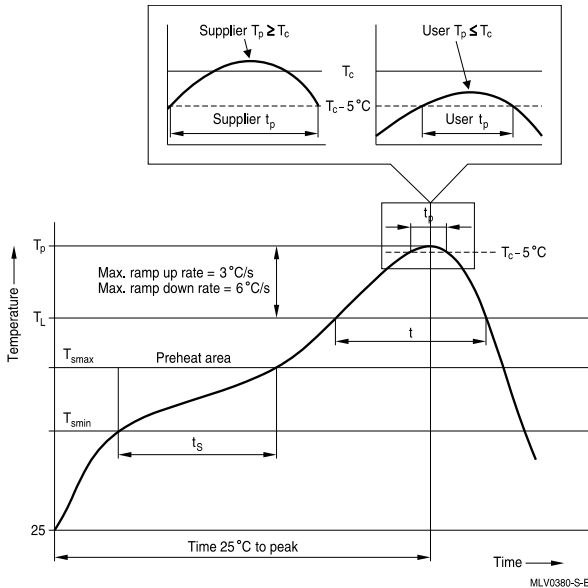

MLV0380-S-E

Profile feature		Sn-Pb eutectic assembly	Pb-free assembly
Preheat and soak			
- Temperature min	$T_{smin}$	100 °C	150 °C
- Temperature max	$T_{smax}$	150 °C	200 °C
- Time	$t_{smin}$ to $t_{smax}$	60 ... 120 s	60 ... 120 s
Average ramp-up rate	$T_L$ to $T_p$	3 °C/ s max.	3 °C/ s max.
Liquidous temperature	$T_L$	183 °C	217 °C
Time at liquidous	$t_L$	60 ... 150 s	60 ... 150 s
Peak package body temperature	$T_p$ <sup>1)</sup>	220 °C ... 235 °C <sup>2)</sup>	245 °C ... 260 °C <sup>2)</sup>
Time ( $t_p$ ) <sup>3)</sup> within 5 °C of specified classification temperature ( $T_c$ )	$t_p$	20 s <sup>3)</sup>	30 s <sup>3)</sup>
Average ramp-down rate	$T_p$ to $T_L$	6 °C/ s max.	6 °C/ s max.
Time 25 °C to peak temperature		maximum 6 min	maximum 8 min

 1) Tolerance for peak profile temperature ( $T_p$ ) is defined as a supplier minimum and a user maximum.

2) Depending on package thickness. For details please refer to JEDEC J-STD-020D.

 3) Tolerance for time at peak profile temperature ( $t_p$ ) is defined as a supplier minimum and a user maximum.

**Note:** All temperatures refer to top side of the package, measured on the package body surface.  
 Number of reflow cycles: 3

**SMD**

Solder joint profiles for silver/nickel/tin terminations

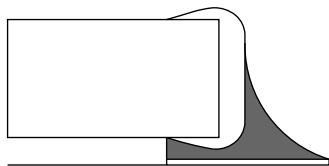

Good solder joint

TNT0565-G-E

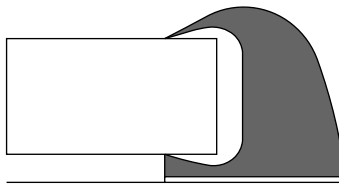

 Too much solder  
Pad geometry too large

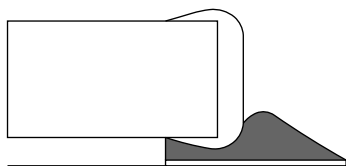
KKE0071-A-E

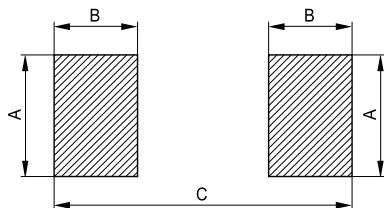

Poor wetting

KKE0072+H-E

**1.3.1 Recommended geometry of solder pads**

KKE0092-X

Recommended maximum dimensions (mm)

Case size inch/mm	A	B	C
0402/1005	0.6	0.6	1.7
0603/1608	1.0	1.0	3.0
0805/2012	1.3	1.2	3.4
1206/3216	1.8	1.2	4.5

**1.3.2 Notes**

Iron soldering should be avoided, hot air methods are recommended for repair purposes.

## SMD

### 2 Conductive adhesion

An alternative to soldering is the gluing of thermistors with conductive adhesives. The benefit of this method is that it involves no thermal stress. The adhesives used must be chemically inert.

### 3 Clamp contacting

Pressure contacting by means of clamps is particularly suitable for applications involving frequent switching and high turn-on powers.

### 4 Cleaning, sealing and potting

Cleaning, sealing or potting processes can affect the reliability of components.

If cleaning is necessary, mild cleaning agents such as ethyl alcohol and cleaning gasoline are recommended. Cleaning agents based on water are not allowed.

When thermistors are sealed, potted or overmolded, there must be no mechanical stress caused by thermal expansion during the production process (curing/ overmolding process) and during later operation. The upper category temperature of the thermistor must not be exceeded. Ensure that the materials used (sealing/ potting compound and plastic material) are chemically neutral.

As thermistors are temperature sensitive components it should be considered that molding can affect the thermal surrounding and may influence e.g. the response time.

Extensive testing is encouraged in order to determine whether overmolding or potting influences the functionality and/ or reliability of the component.

### 5 Storage

In order to maintain their solderability, thermistors must be stored in a non-corrosive atmosphere. Humidity, temperature and container materials are critical factors.

Do not store SMDs where they are exposed to heat or direct sunlight. Otherwise, the packing material may be deformed or SMDs may stick together, causing problems during mounting. After opening the factory seals, such as polyvinyl-sealed packages, use the SMDs as soon as possible.

The components should be left in the original packing. Touching the metallization of unsoldered thermistors may change their soldering properties.

Storage temperature: –25 °C up to 45 °C

Relative humidity (without condensation): ≤75% annual mean

<95%, maximum 30 days per annum

Solder the thermistors listed in this data book after shipment from EPCOS within the time specified:

SMDs: 12 months for Ni-barrier termination  
6 months for AgPd termination

### SMD

## 6 Placement and orientation of SMD NTC thermistors on PCB

### a) Component placement

**Incorrect**



**Correct**

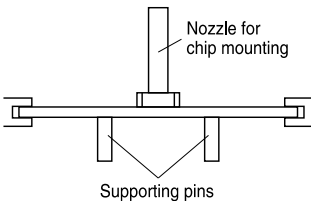

KKE0267-U-E

It is recommended that the PC board should be held by means of some adequate supporting pins such as shown left to prevent the SMDs from being damaged or cracked.

### b) Cracks

SMDs located near an easily warped area

SMD breakage probability due to stress at a breakaway

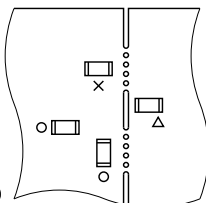
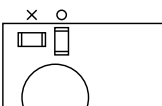

○ = correct  
 × = incorrect  
 △ = incorrect  
 (under certain conditions)

KKE0268-3-E

When placing a component near an area which is apt to bend or a grid groove on the PC board, it is advisable to have both electrodes subjected to uniform stress, or to position the component's electrodes at right angles to the grid groove or bending line (see c) Component orientation).

### c) Component orientation

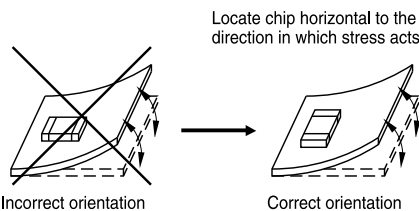

KKE0269-B-E

Choose a mounting position that minimizes the stress imposed on the chip during flexing or bending of the board.

## SMD

### Cautions and warnings

#### General

See "Important notes".

#### Storage

- Store thermistors only in original packaging. Do not open the package prior to processing.
- Storage conditions in original packaging: storage temperature  $-25\text{ }^{\circ}\text{C} \dots +45\text{ }^{\circ}\text{C}$ , relative humidity  $\leq 75\%$  annual mean,  $< 95\%$  maximum 30 days per annum, dew precipitation is inadmissible.
- Do not store thermistors where they are exposed to heat or direct sunlight. Otherwise, the packing material may be deformed or components may stick together, causing problems during mounting.
- Avoid contamination of thermistor surface during storage, handling and processing.
- Avoid storage of thermistors in harmful environments like corrosive gases ( $\text{SO}_x$ , Cl etc).
- Use the components as soon as possible after opening the factory seals, i.e. the polyvinyl-sealed packages.
- Solder SMD NTC thermistors within the time specified after shipment from EPCOS. For SMD components with nickel barrier termination 12 months, for SMD components with AgPd termination 6 months.

#### Handling

- NTC thermistors must not be dropped. Chip-offs or any other damage must not be caused during handling of NTCs.
- Do not touch components with bare hands. Gloves are recommended.
- Avoid contamination of thermistor surface during handling.
- Washing processes may damage the product due to the possible static or cyclic mechanical loads (e.g. ultrasonic cleaning). They may cause cracks to develop on the product and its parts, which might lead to reduced reliability or lifetime.

#### Soldering

- Use resin-type flux or non-activated flux.
- Insufficient preheating may cause ceramic cracks.
- Rapid cooling by dipping in solvent is not recommended.
- Complete removal of flux is recommended.

SMD**Mounting**

- Ensure that no thermo-mechanical stress occurs due to production processes (curing or overmolding processes) when thermistors are sealed, potted or overmolded or during their subsequent operation. The maximum temperature of the thermistor must not be exceeded. Ensure that the materials used (sealing/potting compound and plastic material) are chemically neutral.
- Electrodes/contacts must not be scratched or damaged before/during/after the mounting process.
- Contacts and housing used for assembly with the thermistor must be clean before mounting.
- Ensure that adjacent materials are designed for operation at temperatures comparable to the surface temperature of the thermistor. Be sure that surrounding parts and materials can withstand the temperature.
- Avoid contamination of the thermistor surface during processing.
- The connections of sensors (e.g. cable end, wire end, plug terminal) may only be exposed to an environment with normal atmospheric conditions.
- Avoid using chemical substances as mounting aids. It must be ensured that no water or other liquids enter the NTC thermistors (e.g. through plug terminals). In particular, water based substances (e.g. soap suds) must not be used as mounting aids for sensors.

**Operation**

- Use thermistors only within the specified operating temperature range.
- Use thermistors only within the specified power range.
- Environmental conditions must not harm the thermistors. Only use the thermistors under normal atmospheric conditions or within the specified conditions.
- Contact of NTC thermistors with any liquids and solvents should be prevented. It must be ensured that no water enters the NTC thermistors (e.g. through plug terminals). For measurement purposes (checking the specified resistance vs. temperature), the component must not be immersed in water but in suitable liquids (e.g. perfluoropolyethers such as Galden).
- Avoid dewing and condensation unless thermistor is specified for these conditions.
- Be sure to provide an appropriate fail-safe function to prevent secondary product damage caused by malfunction.

This listing does not claim to be complete, but merely reflects the experience of EPCOS AG.

**SMD**
**Symbols and terms**

Symbol	English	German
A	Area	Fläche
B	B value	B-Wert
B <sub>25/100</sub>	B value determined by resistance measurement at 25 °C and 100 °C	B-Wert, ermittelt durch Widerstandsmessungen bei 25 °C und 100 °C
C <sub>th</sub>	Heat capacitance	Wärmekapazität
I	Current	Strom
N	Number (integer)	Anzahl (ganzzahliger Wert)
P <sub>25</sub>	Maximum power at 25 °C	Maximale Leistung bei 25 °C
P <sub>diss</sub>	Power dissipation	Verlustleistung
P <sub>el</sub>	Electrical power	Elektrische Leistung
P <sub>max</sub>	Maximum power within stated temperature range	Maximale Leistung im angegebenen Temperaturbereich
ΔR <sub>B</sub> /R <sub>B</sub>	Resistance tolerance caused by spread of B value	Widerstandstoleranz, die durch die Streuung des B-Wertes verursacht wird
R <sub>ins</sub>	Insulation resistance	Isolationswiderstand
R <sub>p</sub>	Parallel resistance	Parallelwiderstand
R <sub>R</sub>	Rated resistance	Nennwiderstand
ΔR <sub>R</sub> /R <sub>R</sub>	Resistance tolerance	Widerstandstoleranz
R <sub>S</sub>	Series resistance	Serienwiderstand
R <sub>T</sub>	Resistance at temperature T (e.g. R <sub>25</sub> = resistance at 25 °C)	Widerstand bei Temperatur T (z.B. R <sub>25</sub> = Widerstand bei 25 °C)
T	Temperature	Temperatur
ΔT	Temperature tolerance	Temperaturtoleranz
t	Time	Zeit
T <sub>A</sub>	Ambient temperature	Umgebungstemperatur
T <sub>max</sub>	Upper category temperature	Obere Grenztemperatur (Kategorietemperatur)
T <sub>min</sub>	Lower category temperature	Untere Grenztemperatur (Kategorietemperatur)
T <sub>op</sub>	Operating temperature	Betriebstemperatur
T <sub>R</sub>	Rated temperature	Nenntemperatur
T <sub>surf</sub>	Surface temperature	Oberflächentemperatur
V	Voltage	Spannung
V <sub>ins</sub>	Insulation test voltage	Isolationsprüfspannung
V <sub>op</sub>	Operating voltage	Betriebsspannung
V <sub>test</sub>	Test voltage	Prüfspannung



**SMD**

Symbol	English	German
$\alpha$	Temperature coefficient	Temperaturkoeffizient
$\Delta$	Tolerance, change	Toleranz, Änderung
$\delta_{th}$	Dissipation factor	Wärmeleitwert
$\tau_c$	Thermal cooling time constant	Thermische Abkühlzeitkonstante
$\tau_a$	Thermal time constant	Thermische Zeitkonstante

**Abbreviations / Notes**

Symbol	English	German
<u><b>SMD</b></u>	Surface-mounted devices	Oberflächenmontierbares Bauelement
*	To be replaced by a number in ordering codes, type designations etc.	Platzhalter für Zahl im Bestellnummerncode oder für die Typenbezeichnung.
+	To be replaced by a letter. All dimensions are given in mm. The commas used in numerical values denote decimal points.	Platzhalter für einen Buchstaben. Alle Maße sind in mm angegeben. Verwendete Kommas in Zahlenwerten bezeichnen Dezimalpunkte.

## Important notes

The following applies to all products named in this publication:

1. Some parts of this publication contain **statements about the suitability of our products for certain areas of application**. These statements are based on our knowledge of typical requirements that are often placed on our products in the areas of application concerned. We nevertheless expressly point out **that such statements cannot be regarded as binding statements about the suitability of our products for a particular customer application**. As a rule, EPCOS is either unfamiliar with individual customer applications or less familiar with them than the customers themselves. For these reasons, it is always ultimately incumbent on the customer to check and decide whether an EPCOS product with the properties described in the product specification is suitable for use in a particular customer application.
2. We also point out that **in individual cases, a malfunction of electronic components or failure before the end of their usual service life cannot be completely ruled out in the current state of the art, even if they are operated as specified**. In customer applications requiring a very high level of operational safety and especially in customer applications in which the malfunction or failure of an electronic component could endanger human life or health (e.g. in accident prevention or lifesaving systems), it must therefore be ensured by means of suitable design of the customer application or other action taken by the customer (e.g. installation of protective circuitry or redundancy) that no injury or damage is sustained by third parties in the event of malfunction or failure of an electronic component.
3. **The warnings, cautions and product-specific notes must be observed**.
4. In order to satisfy certain technical requirements, **some of the products described in this publication may contain substances subject to restrictions in certain jurisdictions (e.g. because they are classed as hazardous)**. Useful information on this will be found in our Material Data Sheets on the Internet ([www.epcos.com/material](http://www.epcos.com/material)). Should you have any more detailed questions, please contact our sales offices.
5. We constantly strive to improve our products. Consequently, **the products described in this publication may change from time to time**. The same is true of the corresponding product specifications. Please check therefore to what extent product descriptions and specifications contained in this publication are still applicable before or when you place an order. We also **reserve the right to discontinue production and delivery of products**. Consequently, we cannot guarantee that all products named in this publication will always be available. The aforementioned does not apply in the case of individual agreements deviating from the foregoing for customer-specific products.
6. Unless otherwise agreed in individual contracts, **all orders are subject to the current version of the "General Terms of Delivery for Products and Services in the Electrical Industry" published by the German Electrical and Electronics Industry Association (ZVEI)**.

## Important notes

7. The trade names EPCOS, CeraDiode, CeraLink, CeraPad, CeraPlas, CSMP, CSSP, CTVS, DeltaCap, DigiSiMic, DSSP, ExoCore, FilterCap, FormFit, LeaXield, MiniBlue, MiniCell, MKD, MKK, MotorCap, PCC, PhaseCap, PhaseCube, PhaseMod, PhiCap, PQSine, SIFERRIT, SIFI, SIKOREL, SilverCap, SIMDAD, SiMic, SIMID, SineFormer, SIOV, SIP5D, SIP5K, TFAP, ThermoFuse, WindCap are **trademarks registered or pending** in Europe and in other countries. Further information will be found on the Internet at [www.epcos.com/trademarks](http://www.epcos.com/trademarks).

# Mouser Electronics

Authorized Distributor

Click to View Pricing, Inventory, Delivery & Lifecycle Information:

## EPCOS / TDK:

[B57451V5103J062](#) [B57451V5333J062](#) [B57452V5103J062](#) [B57452V5104J062](#) [B57452V5472J062](#)  
[B57431V2103J62](#) [B57431V2104J62](#) [B57471V5103J062](#) [B57431V2222J62](#) [B57431V2223K62](#) [B57431V2684K62](#)  
[B57431V2684J062](#) [B57431V2223K062](#) [B57431V2472K62](#) [B57431V2333K062](#) [B57431V2153K062](#)  
[B57431V2103K062](#) [B57431V2472M062](#) [B57431V2682K062](#) [B57431V2472J62](#) [B57431V2223J062](#) [B57431V2682J62](#)  
[B57431V2333J62](#) [B57431V2104K62](#) [B57431V2473J62](#) [B57431V2333J062](#) [B57431V2153J062](#) [B57431V2682J062](#)  
[B57431V2222K062](#) [B57431V2682K62](#) [B57431V2472K062](#) [B57431V2223J62](#) [B57431V2153J62](#) [B57431V2333K62](#)  
[B57431V2222K62](#) [B57431V2153K62](#) [B57431V2684K062](#) [B57431V2332J062](#) [B57431V2332J62](#) [B57431V2474J62](#)  
[B57431V2472M62](#) [B57431V2103K62](#) [B57431V2103J162](#) [B57431V2104K062](#) [B57431V2222J062](#) [B57431V2473K62](#)  
[B57431V2684J62](#) [B57431V2472J062](#) [B57431V2473K062](#) [B57451V5333J62](#) [B57452V5104J62](#) [B57451V5103J62](#)  
[B57452V5472J62](#) [B57452V5103J62](#) [B57451V5333H62](#) [B57442V5472H62](#) [B57452V5472H62](#) [B57442V5472J62](#)  
[B57451V5103H62](#) [B57452V5104H62](#) [B57452V5103H62](#) [B57442V5472J062](#) [B57452V5104H062](#) [B57442V5472H062](#)  
[B57452V5472H062](#) [B57451V5103H062](#) [B57451V5473H062](#) [B57442V5103J062](#) [B57451V5473J062](#)  
[B57451V5333H062](#) [B57442V5103H062](#) [B57452V5103H062](#)

Компания «Океан Электроники» предлагает заключение долгосрочных отношений при поставках импортных электронных компонентов на взаимовыгодных условиях!

Наши преимущества:

- Поставка оригинальных импортных электронных компонентов напрямую с производств Америки, Европы и Азии, а так же с крупнейших складов мира;
- Широкая линейка поставок активных и пассивных импортных электронных компонентов (более 30 млн. наименований);
- Поставка сложных, дефицитных, либо снятых с производства позиций;
- Оперативные сроки поставки под заказ (от 5 рабочих дней);
- Экспресс доставка в любую точку России;
- Помощь Конструкторского Отдела и консультации квалифицированных инженеров;
- Техническая поддержка проекта, помощь в подборе аналогов, поставка прототипов;
- Поставка электронных компонентов под контролем ВП;
- Система менеджмента качества сертифицирована по Международному стандарту ISO 9001;
- При необходимости вся продукция военного и аэрокосмического назначения проходит испытания и сертификацию в лаборатории (по согласованию с заказчиком);
- Поставка специализированных компонентов военного и аэрокосмического уровня качества (Xilinx, Altera, Analog Devices, Intersil, Interpoint, Microsemi, Actel, Aeroflex, Peregrine, VPT, Syfer, Eurofarad, Texas Instruments, MS Kennedy, Miteq, Cobham, E2V, MA-COM, Hittite, Mini-Circuits, General Dynamics и др.);

Компания «Океан Электроники» является официальным дистрибьютором и эксклюзивным представителем в России одного из крупнейших производителей разъемов военного и аэрокосмического назначения «JONHON», а так же официальным дистрибьютором и эксклюзивным представителем в России производителя высокотехнологичных и надежных решений для передачи СВЧ сигналов «FORSTAR».



## JONHON

«JONHON» (основан в 1970 г.)

Разъемы специального, военного и аэрокосмического назначения:

(Применяются в военной, авиационной, аэрокосмической, морской, железнодорожной, горно- и нефтедобывающей отраслях промышленности)

«FORSTAR» (основан в 1998 г.)

ВЧ соединители, коаксиальные кабели,  
кабельные сборки и микроволновые компоненты:

(Применяются в телекоммуникациях гражданского и специального назначения, в средствах связи, РЛС, а так же военной, авиационной и аэрокосмической отраслях промышленности).



Телефон: 8 (812) 309-75-97 (многоканальный)

Факс: 8 (812) 320-03-32

Электронная почта: [ocean@oceanchips.ru](mailto:ocean@oceanchips.ru)

Web: <http://oceanchips.ru/>

Адрес: 198099, г. Санкт-Петербург, ул. Калинина, д. 2, корп. 4, лит. А