

IR Receiver Modules for Remote Control Systems



22531-1

FEATURES

- Height of 0.8 mm
- $\pm 75^\circ$ half angle sensitivity
- Low supply current
- Photo detector and preamplifier in one package
- Suitable for all common data formats including those for short bursts
- Supply voltage: 2.5 V to 5.5 V, typically even 2.0 V to 5.5 V is possible
- Improved immunity against ambient light
- Insensitive to supply voltage ripple and noise
- Material categorization: For definitions of compliance please see www.vishay.com/doc?99912



DESCRIPTION

The TSOP573.., TSOP575.. series are miniaturized receiver modules for infrared remote control systems. A PIN diode and a preamplifier are assembled on a lead frame, the epoxy lens cap is designed as an IR filter.

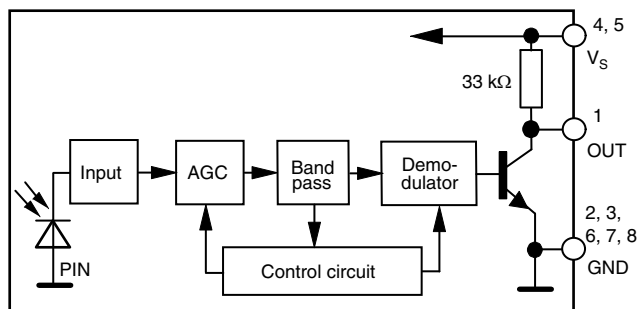
The demodulated output signal can be directly decoded by a microprocessor. The TSOP573.. is compatible with all common IR remote control data formats. It is optimized to suppress almost all spurious pulses from energy saving fluorescent lamps. The TSOP575.. has an excellent noise suppression. It is immune to dimmed LCD backlighting and any fluorescent lamps. IR receivers with AGC3 and AGC5 setting may also suppress some data signals in case of continuous transmission.

This component has not been qualified according to automotive specifications.

PARTS TABLE

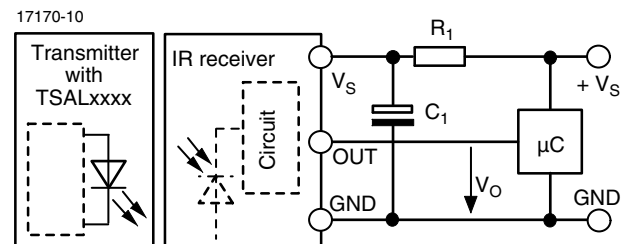
| CARRIER FREQUENCY | STANDARD APPLICATIONS (AGC3) | VERY NOISY ENVIRONMENTS (AGC5) |
|-------------------|------------------------------|--------------------------------|
| 36 kHz | TSOP57336 | TSOP57536 |
| 38 kHz | TSOP57338 | TSOP57538 |
| 40 kHz | TSOP57340 | TSOP57540 |
| 56 kHz | TSOP57356 | TSOP57556 |

BLOCK DIAGRAM



20445-6

APPLICATION CIRCUIT



The external components R_1 and C_1 are optional to improve the robustness against electrical overstress (typical values are $R_1 = 100 \Omega$, $C_1 = 0.1 \mu\text{F}$).

ABSOLUTE MAXIMUM RATINGS

| PARAMETER | TEST CONDITION | SYMBOL | VALUE | UNIT |
|-----------------------------|---|-----------|--------------------------|------|
| Supply voltage | | V_S | - 0.3 to + 6 | V |
| Supply current | | I_S | 5 | mA |
| Output voltage | | V_O | - 0.3 to ($V_S + 0.3$) | V |
| Output current | | I_O | 5 | mA |
| Junction temperature | | T_j | 100 | °C |
| Storage temperature range | | T_{stg} | - 25 to + 85 | °C |
| Operating temperature range | | T_{amb} | - 25 to + 85 | °C |
| Power consumption | $T_{amb} \leq 85 \text{ } ^\circ\text{C}$ | P_{tot} | 10 | mW |

Note

- Stresses beyond those listed under “Absolute Maximum Ratings” may cause permanent damage to the device. This is a stress rating only and functional operation of the device at these or any other conditions beyond those indicated in the operational sections of this specification is not implied. Exposure to absolute maximum rating conditions for extended periods may affect the device reliability.

ELECTRICAL AND OPTICAL CHARACTERISTICS ($T_{amb} = 25 \text{ } ^\circ\text{C}$, unless otherwise specified)

| PARAMETER | TEST CONDITION | SYMBOL | MIN. | TYP. | MAX. | UNIT |
|-----------------------|--|--------------------|------|----------|------|-----------------|
| Supply voltage | | V_S | 2.5 | | 5.5 | V |
| Supply current | $V_S = 5 \text{ V}, E_v = 0$ | I_{SD} | 0.55 | 0.7 | 0.9 | mA |
| | $E_v = 40 \text{ klx, sunlight}$ | I_{SH} | | 0.8 | | mA |
| Transmission distance | $E_v = 0$, IR diode TSAL6200, $I_F = 250 \text{ mA}$, test signal see fig. 1 | d | | 40 | | m |
| Output voltage low | $I_{OSL} = 0.5 \text{ mA}, E_e = 0.7 \text{ mW/m}^2$, test signal see fig. 1 | V_{OSL} | | | 100 | mV |
| Minimum irradiance | Pulse width tolerance: $t_{pi} - 5/f_o < t_{po} < t_{pi} + 6/f_o$, test signal see fig. 1 | $E_e \text{ min.}$ | | 0.2 | 0.4 | mW/m^2 |
| Maximum irradiance | $t_{pi} - 5/f_o < t_{po} < t_{pi} + 6/f_o$, test signal see fig. 1 | $E_e \text{ max.}$ | 50 | | | W/m^2 |
| Directivity | Angle of half transmission distance | $\varphi_{1/2}$ | | ± 75 | | deg |

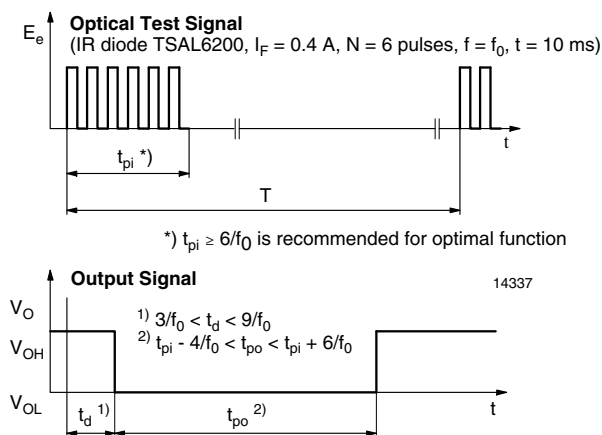
TYPICAL CHARACTERISTICS ($T_{amb} = 25 \text{ } ^\circ\text{C}$, unless otherwise specified)


Fig. 1 - Output Active Low

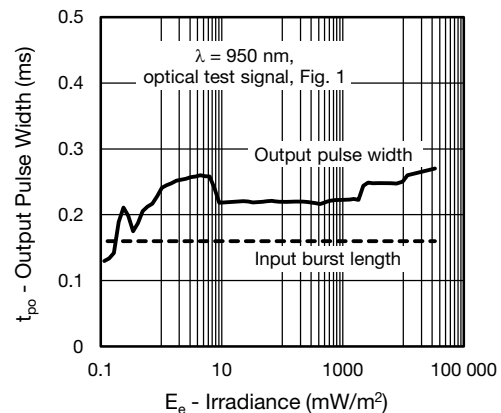


Fig. 2 - Pulse Length and Sensitivity in Dark Ambient

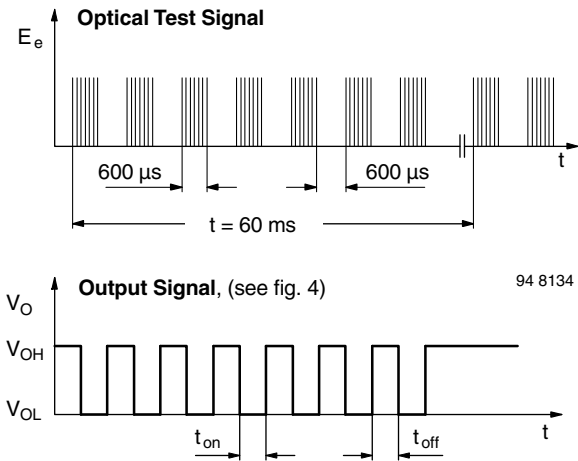


Fig. 3 - Output Function

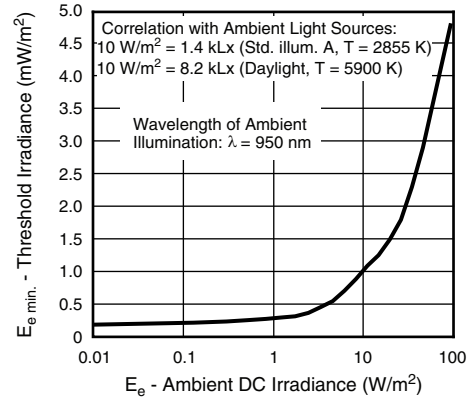


Fig. 6 - Sensitivity in Bright Ambient

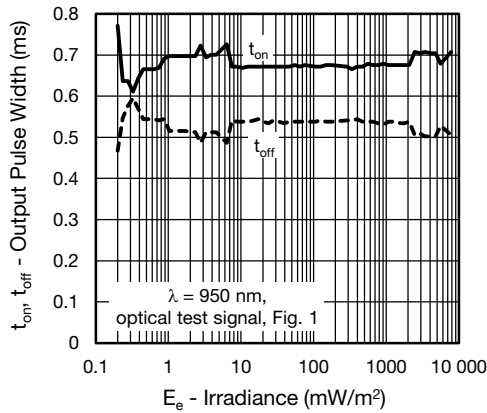


Fig. 4 - Output Pulse Diagram

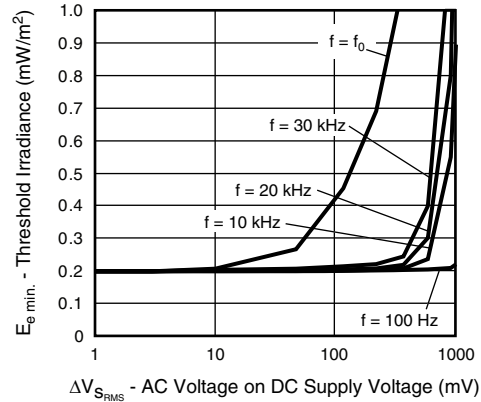


Fig. 7 - Sensitivity vs. Supply Voltage Disturbances

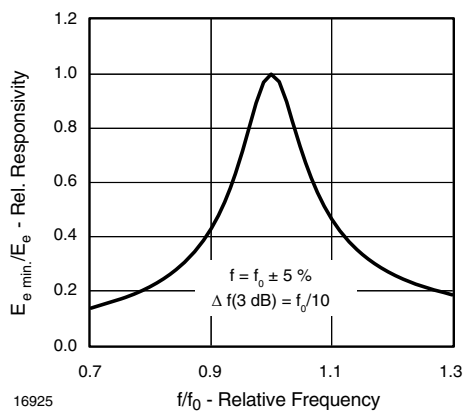


Fig. 5 - Frequency Dependence of Responsivity

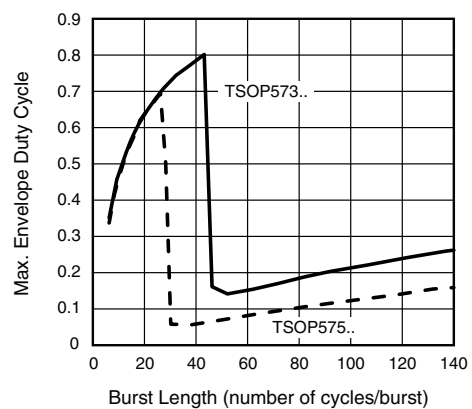


Fig. 8 - Max. Envelope Duty Cycle vs. Burst Length



Fig. 9 - Sensitivity vs. Ambient Temperature



Fig. 12 - Sensitivity vs. Supply Voltage

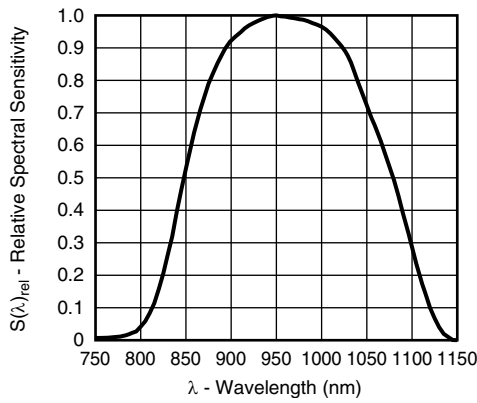


Fig. 10 - Relative Spectral Sensitivity vs. Wavelength



Fig. 11 - Horizontal Directivity

SUITABLE DATA FORMAT

The TSOP573.., TSOP575.. series is designed to suppress spurious output pulses due to noise or disturbance signals. Data and disturbance signals can be distinguished by the devices according to carrier frequency, burst length and envelope duty cycle. The data signal should be close to the band-pass center frequency (e.g. 38 kHz) and fulfill the conditions in the table below.

When a data signal is applied to the TSOP573.., TSOP575.. in the presence of a disturbance signal, the sensitivity of the receiver is reduced to insure that no spurious pulses are present at the output. Some examples of disturbance signals which are suppressed are:

- DC light (e.g. from tungsten bulb or sunlight)
- Continuous signals at any frequency
- Strongly or weakly modulated noise from fluorescent lamps with electronic ballasts (see figure 12 or figure 13)

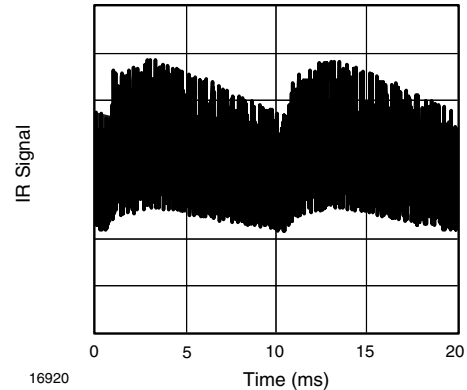


Fig. 13 - IR Signal from Fluorescent Lamp with Low Modulation

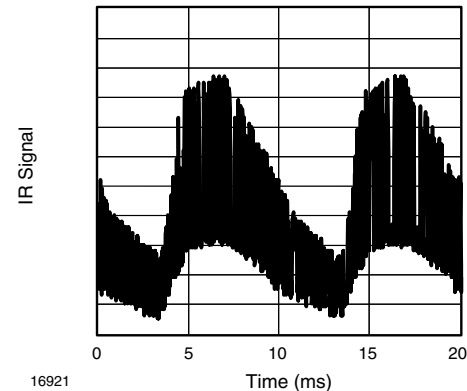


Fig. 14 - IR Signal from Fluorescent Lamp with High Modulation

| | TSOP573.. | TSOP575.. |
|--|--|---|
| Minimum burst length | 6 cycles/burst | 6 cycles/burst |
| After each burst of length a minimum gap time is required of | 10 to 42 cycles ≥ 10 cycles | 10 to 28 cycles ≥ 10 cycles |
| For bursts greater than a minimum gap time in the data stream is needed of | 42 cycles > 7 x burst length | 28 cycles > 12 x burst length |
| Maximum number of continuous short bursts/second | 2000 | 2000 |
| Recommended for NEC code | Yes | Yes |
| Recommended for RC5/RC6 code | Yes | Yes |
| Recommended for r-step code | Yes | Yes |
| Recommended for Thomson 56 kHz code | Yes | Yes |
| Recommended for XMP code | Yes | No |
| Recommended for RCMM code | Yes | Yes |
| Suppression of interference from fluorescent lamps | Most common disturbance signals are suppressed | Even extreme disturbance signals are suppressed |

Note

- For data formats with bursts longer than 12 cycles/burst please see the datasheet for TSOP574..



PACKAGE DIMENSIONS in millimeters



Technical drawings according to DIN specifications

Not indicated tolerances ± 0.1

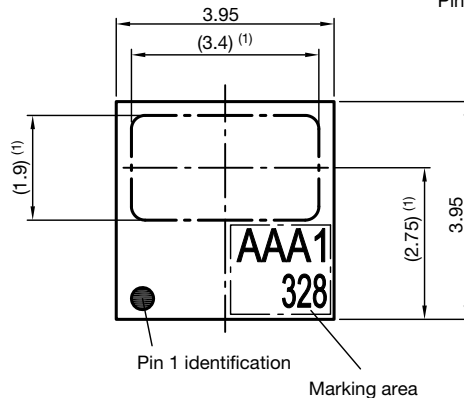
Pinning from Topview



Pin 1 identification



Proposed pad layout from component side (dim. for reference only)



Drawing-No.: 6.550-5315.01-4
Issue: 1; 14.11.11

Note

⁽¹⁾ Optically effective area



ASSEMBLY INSTRUCTIONS

Reflow Soldering

- Reflow soldering must be done within 168 h while stored under a max. temperature of 30 °C, 60 % RH after opening the dry pack envelope
- Set the furnace temperatures for pre-heating and heating in accordance with the reflow temperature profile as shown in the diagram. Exercise extreme care to keep the maximum temperature below 260 °C. The temperature shown in the profile means the temperature at the device surface. Since there is a temperature difference between the component and the circuit board, it should be verified that the temperature of the device is accurately being measured
- Handling after reflow should be done only after the work surface has been cooled off

Manual Soldering

- Use a soldering iron of 25 W or less. Adjust the temperature of the soldering iron below 300 °C
- Finish soldering within 3 s
- Handle products only after the temperature has cooled off

VISHAY LEAD (Pb)-FREE REFLOW SOLDER PROFILE



| ORDERING INFORMATION | | | |
|----------------------|---------------|-----------------------|-----------------------------|
| ORDERING CODE | PACKAGING | VOLUME ⁽¹⁾ | REMARKS |
| TSOP57..TT1 | Tape and reel | MOQ: 1800 pcs | 3.95 mm x 3.95 mm x 0.75 mm |
| TSOP57..TT2 | | MOQ: 7000 pcs | |

Note

⁽¹⁾ MOQ: minimum order quantity

TAPING VERSION TSOP57... DIMENSIONS in millimeters



Drawing-No.: 9.700-5347.01-4
 Issue: 1; 14.11.11

Not indicated tolerances ± 0.1

LABEL

Standard bar code labels for finished goods

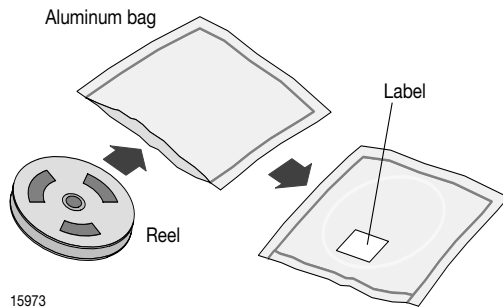
The standard bar code labels are product labels and used for identification of goods. The finished goods are packed in final packing area. The standard packing units are labeled

with standard bar code labels before transported as finished goods to warehouses. The labels are on each packing unit and contain Vishay Semiconductor GmbH specific data.

| VISHAY SEMICONDUCTOR GmbH STANDARD BAR CODE PRODUCT LABEL (finished goods) | | |
|---|---------------------|---------------|
| PLAIN WRITING | ABBREVIATION | LENGTH |
| Item-description | - | 18 |
| Item-number | INO | 8 |
| Selection-code | SEL | 3 |
| LOT-/serial-number | BATCH | 10 |
| Data-code | COD | 3 (YWW) |
| Plant-code | PTC | 2 |
| Quantity | QTY | 8 |
| Accepted by | ACC | - |
| Packed by | PCK | - |
| Mixed code indicator | MIXED CODE | - |
| Origin | xxxxxxx+ | Company logo |
| Long bar code top | Type | Length |
| Item-number | N | 8 |
| Plant-code | N | 2 |
| Sequence-number | X | 3 |
| Quantity | N | 8 |
| Total length | - | 21 |
| Short bar code bottom | Type | Length |
| Selection-code | X | 3 |
| Data-code | N | 3 |
| Batch-number | X | 10 |
| Filter | - | 1 |
| Total length | - | 17 |

DRY PACKING

The reel is packed in an anti-humidity bag to protect the devices from absorbing moisture during transportation and storage.



FINAL PACKING

The sealed reel is packed into a cardboard box. A secondary cardboard box is used for shipping purposes.

RECOMMENDED METHOD OF STORAGE

Dry box storage is recommended as soon as the aluminum bag has been opened to prevent moisture absorption. The following conditions should be observed, if dry boxes are not available:

- Storage temperature 10 °C to 30 °C
- Storage humidity ≤ 60 % RH max.

After more than 168 h under these conditions moisture content will be too high for reflow soldering.

In case of moisture absorption, the devices will recover to the former condition by drying under the following condition: 192 h at 40 °C + 5 °C/- 0 °C and < 5 % RH (dry air/nitrogen) or

96 h at 60 °C + 5 °C and < 5 % RH for all device containers or

24 h at 125 °C + 5 °C not suitable for reel or tubes.

An EIA JEDEC standard JSTD-020 level 3 label is included on all dry bags.

Caution
This bag contains
MOISTURE-SENSITIVE DEVICES

LEVEL
3

If blank, see adjacent bar code label

1. Calculated shelf life in sealed bag: 12 months at <40°C and <90% relative humidity (RH)
2. Peak package body temperature: 260 °C
If blank, see adjacent bar code label
3. After bag is opened, devices that will be subjected to reflow solder or other high temperature process must be
 - a) Mounted within: 168 hours of factory conditions
If blank, see adjacent bar code label
≤30°C/60% RH, or
 - b) Stored per J-STD-033
4. Devices require bake, before mounting, if:
 - a) Humidity Indicator Card reads > 10% for level 2a - 5a devices or >60% for level 2 devices when read at 23±5°C
 - b) 3a or 3b are not met
5. If baking is required, refer to IPC/JEDEC J-STD-033 for bake procedure

Bag Seal Date: _____
If blank, see adjacent bar code label

Note: Level and body temperature defined by IPC/JEDEC J-STD-020

22650

EIA JEDEC standard JSTD-020 level 3 label is included on all dry bags

VISHAY SEMICONDUCTORS STANDARD BAR CODE LABELS

The Vishay Semiconductors standard bar code labels are printed at final packing areas. The labels are on each packing unit and contain Vishay Semiconductors specific data.

BAR CODE PRODUCT LABEL (example)



22178

ESD PRECAUTION

Proper storage and handling procedures should be followed to prevent ESD damage to the devices especially when they are removed from the antistatic shielding bag. Electro-static sensitive devices warning labels are on the packaging.



Disclaimer

ALL PRODUCT, PRODUCT SPECIFICATIONS AND DATA ARE SUBJECT TO CHANGE WITHOUT NOTICE TO IMPROVE RELIABILITY, FUNCTION OR DESIGN OR OTHERWISE.

Vishay Intertechnology, Inc., its affiliates, agents, and employees, and all persons acting on its or their behalf (collectively, "Vishay"), disclaim any and all liability for any errors, inaccuracies or incompleteness contained in any datasheet or in any other disclosure relating to any product.

Vishay makes no warranty, representation or guarantee regarding the suitability of the products for any particular purpose or the continuing production of any product. To the maximum extent permitted by applicable law, Vishay disclaims (i) any and all liability arising out of the application or use of any product, (ii) any and all liability, including without limitation special, consequential or incidental damages, and (iii) any and all implied warranties, including warranties of fitness for particular purpose, non-infringement and merchantability.

Statements regarding the suitability of products for certain types of applications are based on Vishay's knowledge of typical requirements that are often placed on Vishay products in generic applications. Such statements are not binding statements about the suitability of products for a particular application. It is the customer's responsibility to validate that a particular product with the properties described in the product specification is suitable for use in a particular application. Parameters provided in datasheets and/or specifications may vary in different applications and performance may vary over time. All operating parameters, including typical parameters, must be validated for each customer application by the customer's technical experts. Product specifications do not expand or otherwise modify Vishay's terms and conditions of purchase, including but not limited to the warranty expressed therein.

Except as expressly indicated in writing, Vishay products are not designed for use in medical, life-saving, or life-sustaining applications or for any other application in which the failure of the Vishay product could result in personal injury or death. Customers using or selling Vishay products not expressly indicated for use in such applications do so at their own risk. Please contact authorized Vishay personnel to obtain written terms and conditions regarding products designed for such applications.

No license, express or implied, by estoppel or otherwise, to any intellectual property rights is granted by this document or by any conduct of Vishay. Product names and markings noted herein may be trademarks of their respective owners.

Material Category Policy

Vishay Intertechnology, Inc. hereby certifies that all its products that are identified as RoHS-Compliant fulfill the definitions and restrictions defined under Directive 2011/65/EU of The European Parliament and of the Council of June 8, 2011 on the restriction of the use of certain hazardous substances in electrical and electronic equipment (EEE) - recast, unless otherwise specified as non-compliant.

Please note that some Vishay documentation may still make reference to RoHS Directive 2002/95/EC. We confirm that all the products identified as being compliant to Directive 2002/95/EC conform to Directive 2011/65/EU.

Vishay Intertechnology, Inc. hereby certifies that all its products that are identified as Halogen-Free follow Halogen-Free requirements as per JEDEC JS709A standards. Please note that some Vishay documentation may still make reference to the IEC 61249-2-21 definition. We confirm that all the products identified as being compliant to IEC 61249-2-21 conform to JEDEC JS709A standards.

Компания «Океан Электроники» предлагает заключение долгосрочных отношений при поставках импортных электронных компонентов на взаимовыгодных условиях!

Наши преимущества:

- Поставка оригинальных импортных электронных компонентов напрямую с производств Америки, Европы и Азии, а так же с крупнейших складов мира;
- Широкая линейка поставок активных и пассивных импортных электронных компонентов (более 30 млн. наименований);
- Поставка сложных, дефицитных, либо снятых с производства позиций;
- Оперативные сроки поставки под заказ (от 5 рабочих дней);
- Экспресс доставка в любую точку России;
- Помощь Конструкторского Отдела и консультации квалифицированных инженеров;
- Техническая поддержка проекта, помощь в подборе аналогов, поставка прототипов;
- Поставка электронных компонентов под контролем ВП;
- Система менеджмента качества сертифицирована по Международному стандарту ISO 9001;
- При необходимости вся продукция военного и аэрокосмического назначения проходит испытания и сертификацию в лаборатории (по согласованию с заказчиком);
- Поставка специализированных компонентов военного и аэрокосмического уровня качества (Xilinx, Altera, Analog Devices, Intersil, Interpoint, Microsemi, Actel, Aeroflex, Peregrine, VPT, Syfer, Eurofarad, Texas Instruments, MS Kennedy, Miteq, Cobham, E2V, MA-COM, Hittite, Mini-Circuits, General Dynamics и др.);

Компания «Океан Электроники» является официальным дистрибьютором и эксклюзивным представителем в России одного из крупнейших производителей разъемов военного и аэрокосмического назначения «JONHON», а так же официальным дистрибьютором и эксклюзивным представителем в России производителя высокотехнологичных и надежных решений для передачи СВЧ сигналов «FORSTAR».



JONHON

«JONHON» (основан в 1970 г.)

Разъемы специального, военного и аэрокосмического назначения:

(Применяются в военной, авиационной, аэрокосмической, морской, железнодорожной, горно- и нефтедобывающей отраслях промышленности)

«FORSTAR» (основан в 1998 г.)

ВЧ соединители, коаксиальные кабели, кабельные сборки и микроволновые компоненты:

(Применяются в телекоммуникациях гражданского и специального назначения, в средствах связи, РЛС, а так же военной, авиационной и аэрокосмической отраслях промышленности).



Телефон: 8 (812) 309-75-97 (многоканальный)

Факс: 8 (812) 320-03-32

Электронная почта: ocean@oceanchips.ru

Web: <http://oceanchips.ru/>

Адрес: 198099, г. Санкт-Петербург, ул. Калинина, д. 2, корп. 4, лит. А