

Product Family: [Chip Power Resistor](#)

Part Number Series: [CP*2512*#####FS](#)



Susumu World Group

 <p>Standard CP*2512, CP*2525 shown in image</p>	<p>Construction:</p> <ul style="list-style-type: none"> 99.5% BeO or High Purity Alumina Nickel alloy thin-film resistive element Epoxy-resin overcoat Pre-tinned (Sn100, matte) terminations over Ni barrier is standard 	<p>Features:</p> <ul style="list-style-type: none"> TCR's to $\pm 25\text{ppm}/^\circ\text{C}$ Tolerances less than $\pm 1\%$ available Standard and custom sizes & terminations available (Sn60Pb40 option) High volume production, suitable for commercial and special applications Competitive pricing
--	--	---

Description:

These power resistors are designed to tolerate high current and establish a low thermal resistance interface with the circuit board. A lower thermal resistance more efficiently sinks heat to the board, enabling a larger effective area for heat dissipation. As a result, much lower surface temperatures are achievable in comparison to standard chip resistors for the same chip size and applied power.

Dimensions:

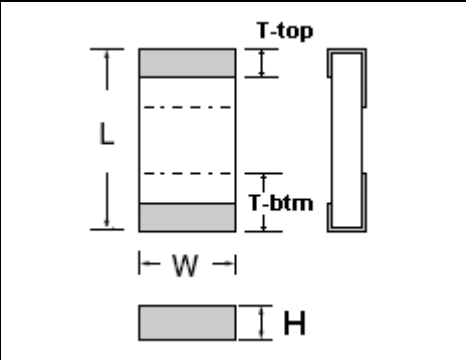
	Size		Standard Dimensions (mm)				
	Inch	Metric	L	W	H	T-top	T-btm
	2512	6332	6.3 ± 0.2	3.2 ± 0.2	0.7 ± 0.1	0.9 ± 0.2	2.0 ± 0.2
Call for other sizes and/or termination styles							

Electrical Specifications:

Size: Inch (Metric)	2512 (6332)	
Rated Power ^{1,2} (Alumina)	Up to 16W ^{1,2}	
Rated Power ^{1,2} (BeO)	Up to 16W ^{1,2} (Up to 60W to be qualified soon)	
Rated Voltage	$\sqrt{(P \times R)}$	
Resistance Tolerance	$\pm 1\%$	
Standard Resistance Values (E12)	3.3 to 120 Ω Call for other values	
TCR (ppm/ $^\circ\text{C}$) ³	± 25 (E)	$> 22 \Omega$
	± 50 (Q)	3.3 to 22 Ω
Operating Temperature Range ⁴	-55 to 155 $^\circ\text{C}$	
Insulation Resistance (100V, 1min) ⁵	$> 1\text{G}\Omega$	

CPA2512 Derating Curve Examples:⁶

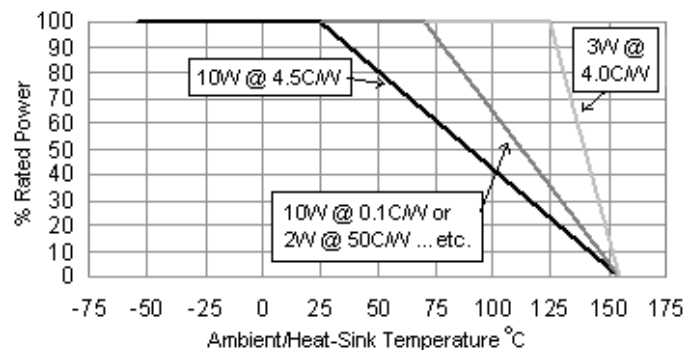

Notes:

- Dependent on effective thermal conductivity/resistance of board construction/land design and size of board - greater power capability for board/land with lower thermal resistance. For relatively high thermal resistance mountings, the power resistors are capable of generating sufficient heat to reflow solder bonds without device damage.
- Refer to Thermal Performance Plot below.
- Per MIL-PRF-55342 (-55/25/125 $^\circ\text{C}$).
- Per MIL-PRF-55342.
- Per IEC 60115-1.
- Derating curves are derived from the thermal performance plots.

Thermal Performance:

Peak Surface Temperature Rise of CPA2512*#####S per Board Thermal Resistance and Applied Power
(see notes below for details)

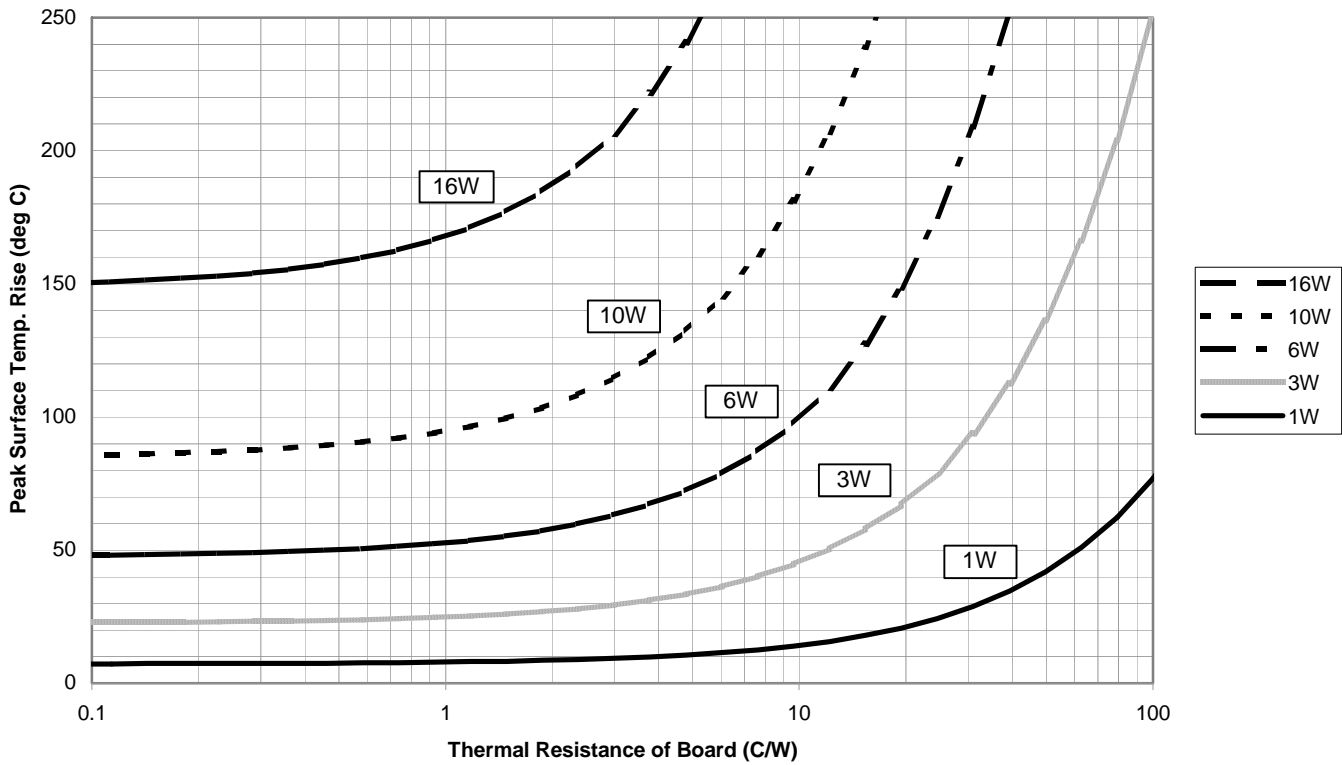

Peak Surface Temperature Rise of CPB2512*#####S per Board Thermal Resistance and Applied Power
(see notes below for details)

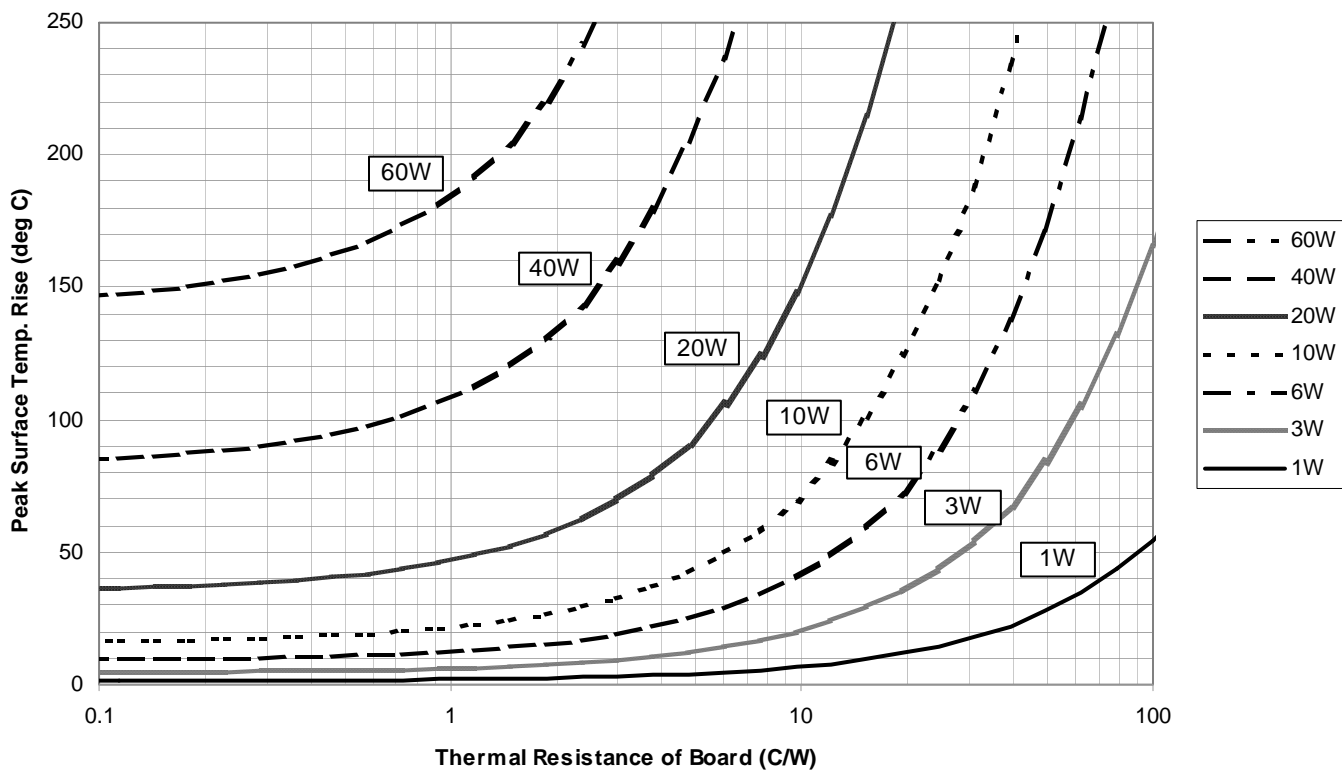

Notes:

- Plots produced via characterization of thermal coefficients determined from experimental measurements (via thermal imaging camera) at thermal equilibrium with parts mounted to various boards (with homogeneous thermal conductivity to minimize uncertainty) per recommended solder pad dimensions and with boards pressed against a Cu carrier/heat-sink (not ideal) with a thermal compound interface in a static environment (no air flow).
- Heat flow primarily through thickness of board with virtually zero lateral heat transfer in board.
- Thermal resistance of test boards were calculated based on material manufacturer specified thermal conductivity (20°C) via the following: Thermal Resistance (°C/W) = $L / (k \cdot A)$, where Thermal Conductivity, k (W/m•K) = $(L / (A \cdot \Delta T)) \cdot \Delta Q / \Delta t$, L = Thickness of board in meters and A = area of chip resistor in meters (2512 size = 6.3x3.2mm)
- The relationships between peak surface temperature rise, power, and board thermal resistance are linear, but the x-axis is plotted in log-scale to offer greater resolution at lower board thermal resistances.

Recommended Solder Pad Dimensions:

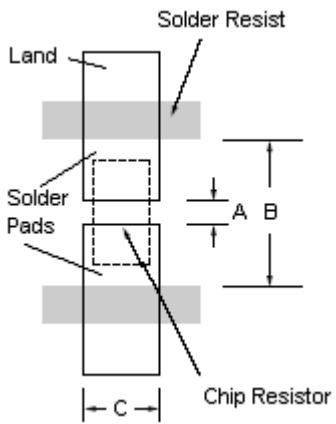
		
	Standard Dimensions (mm)	
	Size: Inch (Metric)	2512 (6332)
	A	1.6
	B	7.7
C	3.5	

Environmental Performance Specifications:

Test	Reference	Conditions of Test	Requirement
Life ⁴	MIL-PRF-55342, MIL-STD-202 Method 108A	70°C, 2000h, rated power ³ , 1.5h on, 0.5h off	± 0.5% + 0.01Ω
Thermal Shock	MIL-PRF-55342, MIL-STD-202 Method 107G	Condition F-3, -65°C/0.25h to 155°C/0.25h, 100 cycles	± 0.1% + 0.01Ω
High Temperature Exposure	MIL-PRF-55342	155°C, 100h	± 0.1% + 0.01Ω
Short Time Overload ⁴	MIL-PRF-55342	6.25x rated power ³ , 5 sec.	± 0.1% + 0.01Ω
Moisture Resistance	MIL-PRF-55342, MIL-STD-202 Method 106G	25/65/25/65/25/-10°C, 90% to 98%RH, 10 cycles, 24h/cycle, with and without bias, bias = 1.5h on, 0.5h off @ 1/10 th rated power ³	± 0.1% + 0.01Ω
Resistance to Soldering Heat ¹	MIL-PRF-55342, MIL-STD-202 Method 210F	260°C for 15 sec., over 220°C for 60 sec., 3 cycles	± 0.1% + 0.01Ω
Solderability ²	MIL-PRF-55342, MIL-STD-202 Method 208H	Precondition E: 150°C dry bake for 16h, Method 1 “Dip and Look Test”, 245°C, 5 sec., Pb-free (SnAgCu) Solder	Min 95% coverage of critical area
Board Flex	IEC 60115-1 / JIS C 5202	Bend amount of 3mm, measurements during and after bend	± 0.1% + 0.01Ω, No mech. damage
Terminal Strength	MIL-PRF-55342	Force of 3kg for 30 sec.	No mech. damage

Notes:

- Test conditions modified to represent the high temperature Pb-free reflow conditions and an extra cycle is added.
- JESD22-B102D adds test conditions for Pb-free and is aligned with J-STD-002B referenced in MIL-STD-202 Method 208H. JESD22-B102D procedure comes from EIA-638, “Surface Mount Solderability Test”.
- Parts mounted to boards in accordance with NEMA grade FR-4 of IPC-4101 (62mils thick) with no Cu carrier/heat-sink at a rated power of 2W (Board Therm. Res. ~ 72C/W).
- Due to the complexity of managing the heat load of hundreds of pieces during qualification, long-term reliability testing for the 16W power rating had been conducted in terms of the equivalent current density via much thinner/narrower resistor patterns to limit the heat load. Full power testing is being conducted on a smaller scale – to be completed soon.

Tape & Reel Packaging Specifications:

Packaging Specifications	General Guidelines & Recommendations
Packaging Materials	2512 size carrier tape part#: US016151/TMT12MV137. Cover tape part #: Vendor determined. Reel size: 7 or 13 inch, quantity dependent.
Packaging Requirements	All taping done in accordance with EIA 481 standards. Pieces taped with the marking up and showing through the cover tape (as shown in the drawing below). All orders under 100pcs, will be put on cut tape only with no leader or trailer. Orders will be taped as follows; <ul style="list-style-type: none"> ▪ 1000 piece quantity is on a 7 inch reel ▪ 5000 piece quantity is on a 13 inch reel See part numbering section for ordering information.
Labeling Requirements	Labels will contain the TFT part number and quantity of pieces taped.

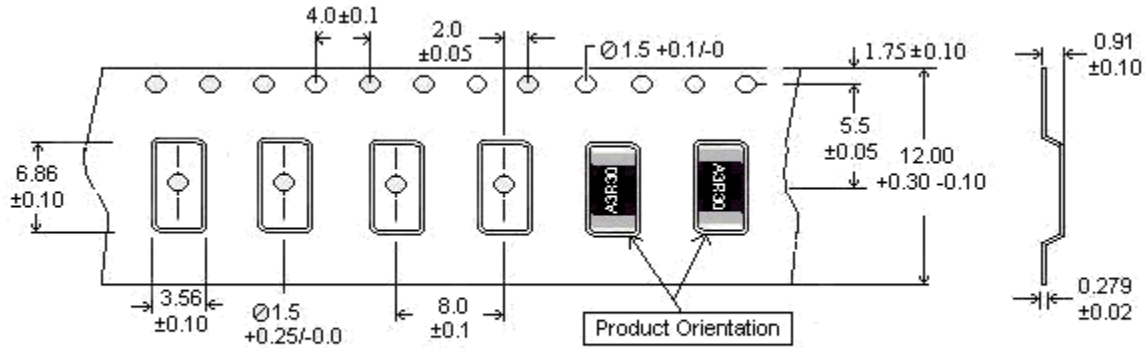

Not drawn to scale (Dimensions in mm)

Marking:



Marking shall include:

- Material Designator (A = Alumina, B = BeO)
- The 4-digit Resistance Value (MIL-STD-1285D)

Ex. A27R0 = 27.0Ω Resistance with Alumina Material

Part Numbering: (Ex. CPA2512E27R0FS-T10)

CP	A	2512	E	27R0	F	S	-T10
Product Designator	Material Designator	Size, Inch	TCR	Resistance Value	Tolerance	Custom Designator	Packaging Tape & Reel
CP	A = Alumina B = BeO	Refer to table above	E = ± 25 ppm/°C Q = ± 50 ppm/°C	Ex. 27R0 = 27.0 Ω	F = ± 1%	Standard = S Custom = TBD	-T10 = 1000 -T50 = 5000

Thin Film Technology Corp., 1980 Commerce Drive, North Mankato, MN 56003, (507) 625-8445

www.thin-film.com

Компания «Океан Электроники» предлагает заключение долгосрочных отношений при поставках импортных электронных компонентов на взаимовыгодных условиях!

Наши преимущества:

- Поставка оригинальных импортных электронных компонентов напрямую с производств Америки, Европы и Азии, а так же с крупнейших складов мира;
- Широкая линейка поставок активных и пассивных импортных электронных компонентов (более 30 млн. наименований);
- Поставка сложных, дефицитных, либо снятых с производства позиций;
- Оперативные сроки поставки под заказ (от 5 рабочих дней);
- Экспресс доставка в любую точку России;
- Помощь Конструкторского Отдела и консультации квалифицированных инженеров;
- Техническая поддержка проекта, помощь в подборе аналогов, поставка прототипов;
- Поставка электронных компонентов под контролем ВП;
- Система менеджмента качества сертифицирована по Международному стандарту ISO 9001;
- При необходимости вся продукция военного и аэрокосмического назначения проходит испытания и сертификацию в лаборатории (по согласованию с заказчиком);
- Поставка специализированных компонентов военного и аэрокосмического уровня качества (Xilinx, Altera, Analog Devices, Intersil, Interpoint, Microsemi, Actel, Aeroflex, Peregrine, VPT, Syfer, Eurofarad, Texas Instruments, MS Kennedy, Miteq, Cobham, E2V, MA-COM, Hittite, Mini-Circuits, General Dynamics и др.);

Компания «Океан Электроники» является официальным дистрибьютором и эксклюзивным представителем в России одного из крупнейших производителей разъемов военного и аэрокосмического назначения «JONHON», а так же официальным дистрибьютором и эксклюзивным представителем в России производителя высокотехнологичных и надежных решений для передачи СВЧ сигналов «FORSTAR».



JONHON

«JONHON» (основан в 1970 г.)

Разъемы специального, военного и аэрокосмического назначения:

(Применяются в военной, авиационной, аэрокосмической, морской, железнодорожной, горно- и нефтедобывающей отраслях промышленности)

«FORSTAR» (основан в 1998 г.)

ВЧ соединители, коаксиальные кабели, кабельные сборки и микроволновые компоненты:

(Применяются в телекоммуникациях гражданского и специального назначения, в средствах связи, РЛС, а так же военной, авиационной и аэрокосмической отраслях промышленности).



Телефон: 8 (812) 309-75-97 (многоканальный)

Факс: 8 (812) 320-03-32

Электронная почта: ocean@oceanchips.ru

Web: <http://oceanchips.ru/>

Адрес: 198099, г. Санкт-Петербург, ул. Калинина, д. 2, корп. 4, лит. А