

ZXLD1362
60V 1A LED DRIVER WITH AEC-Q100

Description

The ZXLD1362 is a continuous mode inductive step-down converter with integrated switch and high side current sense.

It operates from an input supply from 6V to 60V driving single or multiple series connected LEDs efficiently externally adjustable output current up to 1A.

The ZXLD1362 has been qualified to AEC-Q100 Grade 1 enabling operation in ambient temperatures from -40°C to +125°C.

The output current can be adjusted by applying a DC voltage or a PWM waveform. 100.1 adjustment of output current is possible using PWM control.

Applying 0.2V or lower to the ADJ pin turns the output off and switches the device into a low current standby state.

Pin Assignments

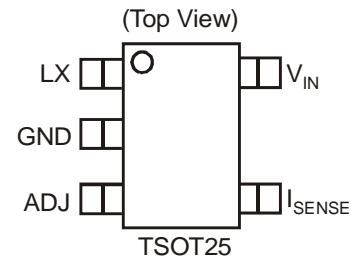

Features

- Simple low parts count
- Single pin on/off and brightness control using DC voltage or PWM
- High efficiency (up to 95%)
- Wide input voltage range: 6V to 60V
- Up to 1MHz switching frequency
- Qualified to AEC-Q100 Grade 1
- Typical 2% output current accuracy
- Thermally enhanced TSOT25: θ_{JA} 82°C/W
- Available in Green molding
 - **Totally Lead-Free & Fully RoHS Compliant (Notes 1 & 2)**
 - **Halogen and Antimony Free. "Green" Device (Note 3)**

Notes: 1. No purposely added lead. Fully EU Directive 2002/95/EC (RoHS) & 2011/65/EU (RoHS 2) compliant.
 2. See <http://www.diodes.com> for more information about Diodes Incorporated's definitions of Halogen- and Antimony-free, "Green" and Lead-free.
 3. Halogen- and Antimony-free "Green" products are defined as those which contain <900ppm bromine, <900ppm chlorine (<1500ppm total Br + Cl) and <1000ppm antimony compounds.

Typical Application Circuit

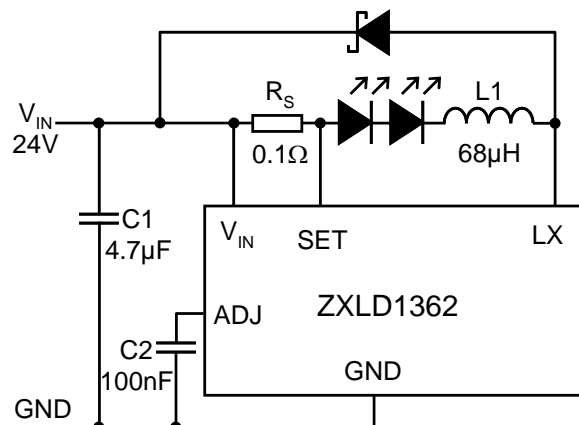

Pin Description

Name	Pin No.	Function
LX	1	Drain of NDMOS switch
GND	2	Ground (0V)
ADJ	3	Multi-function On/Off and brightness control pin: <ul style="list-style-type: none"> • Leave floating for normal operation. ($V_{ADJ} = V_{REF} = 1.25V$ giving nominal average output current <ul style="list-style-type: none"> ◦ $I_{OUTnom} = 0.1/RS$) • Drive to voltage below 0.2V to turn off output current • Drive with DC voltage ($0.3V < V_{ADJ} < 2.5V$) to adjust output current from 25% to 200% of I_{OUTnom} • Connect a capacitor from this pin to ground to increase soft-start time. • Soft-start time increases approximately $200\mu s/nF$.
I_{SENSE}	4	Connect resistor R_S from this pin to V_{IN} to define nominal average output current $I_{OUTnom} = 0.1/RS$ (Note: $R_{SMIN} = 0.1\Omega$ with ADJ pin open circuit)
V_{IN}	5	Input voltage (6V to 60V). Decouple to ground with 4.7 μF of higher X7R ceramic capacitor close to device.

Block Diagram

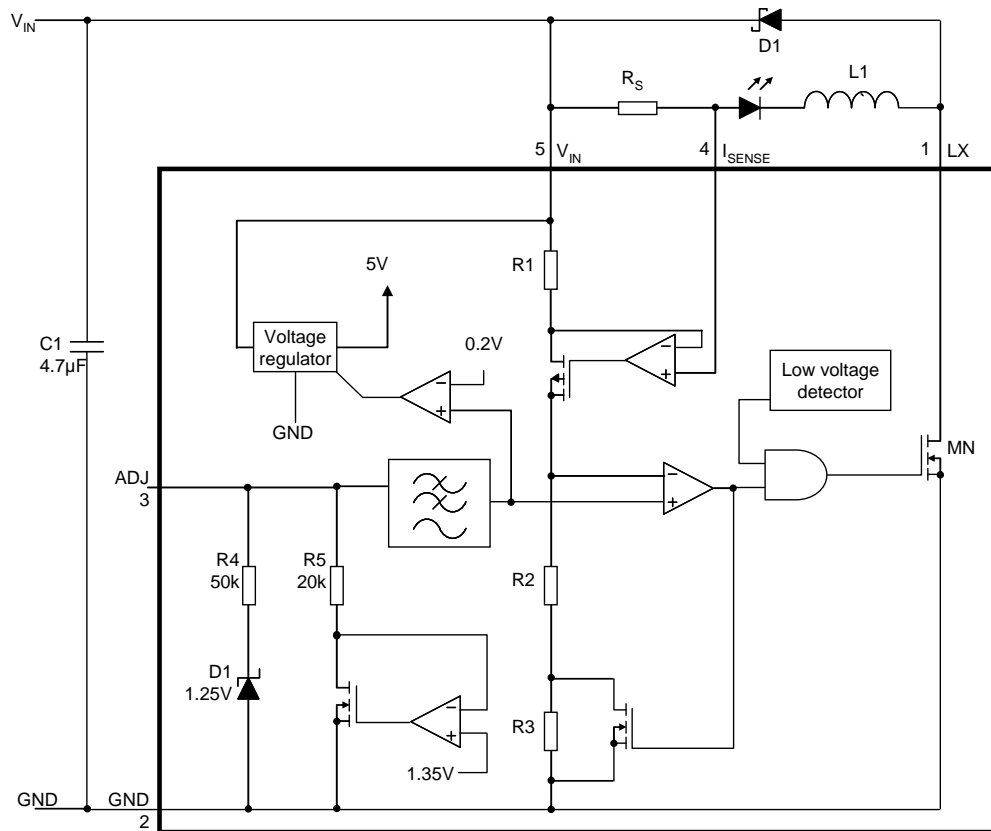

Figure 1. Block Diagram

Absolute Maximum Ratings (Note 4)

Symbol	Parameter	Rating	Unit
V_{IN}	Input Voltage	-0.3 to +65	V
V_{SENSE}	I_{SENSE} Voltage (Note 5)	+0.3 to -5	V
V_{LX}	LX Output Voltage	-0.3 to +65	V
V_{ADJ}	Adjust Pin Input Voltage	-0.3 to +6	V
I_{LX}	Switch Output Current	1.25	A
P_{TOT}	Power Dissipation (Refer to Package thermal de-rating curve on page 16)	1	W
T_{ST}	Storage Temperature	-55 to +150	°C
$T_{J\ MAX}$	Junction Temperature	150	°C

Note: 4 All voltages unless otherwise stated are measured with respect to GND.
5. V_{SENSE} is measured with respect to V_{IN} .

Caution: Stresses greater than the 'Absolute Maximum Ratings' specified above, may cause permanent damage to the device. These are stress ratings only; functional operation of the device at conditions between maximum recommended operating conditions and absolute maximum ratings is not implied. Device reliability may be affected by exposure to absolute maximum rating conditions for extended periods of time.

ESD Susceptibility		
	Rating	Unit
Human Body Model	500	V
Machine Model	75	V

Caution: Semiconductor devices are ESD sensitive and may be damaged by exposure to ESD events. Suitable ESD precautions should be taken when handling and transporting these devices.
The human body model is a 100pF capacitor discharge through a 1.5kΩ resistor pin. The machine model is a 200pF capacitor discharged directly into each pin.

Thermal Resistance

Symbol	Parameter	Rating	Unit
θ_{JA}	Junction to Ambient	82	°C/W
Ψ_{JB}	Junction to Board	33	°C/W

Recommended Operating Conditions

Symbol	Parameter	Min	Max	Units
V_{IN}	Input Voltage Range (Note 6)	6	60	V
I_{LX}	Maximum recommended continuous/RMS switch current		1	A
V_{ADJ}	External control voltage range on ADJ pin for DC brightness control (Note 7)	0.3	2.5	V
V_{ADJoff}	DC voltage on ADJ pin to ensure devices is off		0.25	V
t_{ONMIN}	Minimum switch on-time		800	ns
f_{LXmax}	Recommended maximum operating frequency (Note 8)		625	kHz
D_{LX}	Duty cycle range	0.01	0.99	
T_A	Ambient operating temperature range	-40	+125	°C

Notes: 6. $V_{IN} > 16V$ to fully enhance output transistor. Otherwise out current must be derated - see graphs. Operation at low supply may cause excessive heating due to increased on-resistance. Tested at 7V guaranteed for 6V by design.
7. 100% brightness corresponds to $V_{ADJ} = V_{ADJ(nom)} = V_{REF}$. Driving the ADJ pin above V_{REF} will increase the V_{SENSE} threshold and output current proportionally.
8. ZXLD1362 will operate at higher frequencies but accuracy will be affected due to propagation delays.

Electrical Characteristics (Test conditions: $V_{IN} = 24V$, $T_A = +25^{\circ}C$, unless otherwise specified.)

Symbol	Parameter	Condition	Min	Typ	Max	Unit
V_{SU}	Internal regulator start-up threshold			4.85		V
V_{SD}	Internal regulator shutdown threshold			4.75		V
I_{INQoff}	Quiescent supply current with output off	ADJ pin grounded		65	90	μA
I_{INQon}	Quiescent supply current with output switching (Note 9)	ADJ pin floating, $L = 68\mu H$, 3 LEDs, $f = 260kHz$		1.8		mA
V_{SENSE}	Mean current sense threshold voltage (Defines LED current setting accuracy)	Measured on I_{SENSE} pin with respect to V_{IN} $V_{ADJ} = 1.25V$	95	100	105	mV
$V_{SENSEHYS}$	Sense threshold hysteresis			± 10		%
I_{SENSE}	I_{SENSE} pin input current	$V_{SENSE} = V_{IN} - 0.1$		4	10	μA
V_{REF}	Internal reference voltage	Measured on ADJ pin with pin floating		1.25		V
$\Delta V_{REF}/\Delta T$	Temperature coefficient of V_{REF}			50		ppm/ $^{\circ}C$
V_{ADJ}	External control voltage range on ADJ pin for DC brightness control (Note 7)		0.3		2.5	V
V_{ADJoff}	DC voltage on ADJ pin to switch device from active (on) state to quiescent (off) state	V_{ADJ} falling	0.15	0.2	0.27	V
V_{ADJon}	DC voltage on ADJ pin to switch device from quiescent (off) state to active (on) state	V_{ADJ} rising	0.2	0.25	0.3	V
R_{ADJ}	Resistance between ADJ pin and V_{REF}	$0 < V_{ADJ} < V_{REF}$ $V_{ADJ} > V_{REF} + 100mV$	30 10.4	50 14.2	65 18	k Ω
I_{LXmean}	Continuous LX switch current				1	A
R_{LX}	LX switch 'On' resistance	@ $I_{LX} = 1A$		0.5	1.0	Ω
$I_{LX(leak)}$	LX switch leakage current				5	μA
$DPWM(LF)$	Duty cycle range of PWM signal applied to ADJ pin during low frequency PWM dimming mode	PWM frequency <300Hz PWM amplitude = V_{REF}	0.001		1	
	Brightness control range	Measured on ADJ pin			1000:1	
DC_{ADJ}	DC Brightness control range	Note 10		5:1		
t_{SS}	Soft start time	Time taken for output current to reach 90% of final value after voltage on ADJ pin has risen above 0.3V. Requires external capacitor 22nF. See graphs for more details		2		ms
f_{LX}	Operating frequency (See graphs for more details)	ADJ pin floating $L = 68\mu H$ (0.1V) $I_{OUT} = 1A$ @ $V_{LED} = 3.6V$ Driving 3 LEDs		300		kHz
t_{ONmin}	Minimum switch 'ON' time	LX switch 'ON'		130		ns
t_{OFFmin}	Minimum switch 'OFF' time	LX switch 'OFF'		70		ns

Notes: 9. Static current of device is approximately 700 μA , see Graph, Page 16.

10. Ratio of maximum brightness to minimum brightness before shutdown $V_{REF} = 1.25/0.3$. V_{REF} externally driven to 2.5V, ratio 10:1.

Device Description

The device, in conjunction with the coil (L1) and current sense resistor (R_S), forms a self-oscillating continuous-mode buck converter.

Device operation (refer to Figure 1 - Block diagram and Figure 2 Operating waveforms)

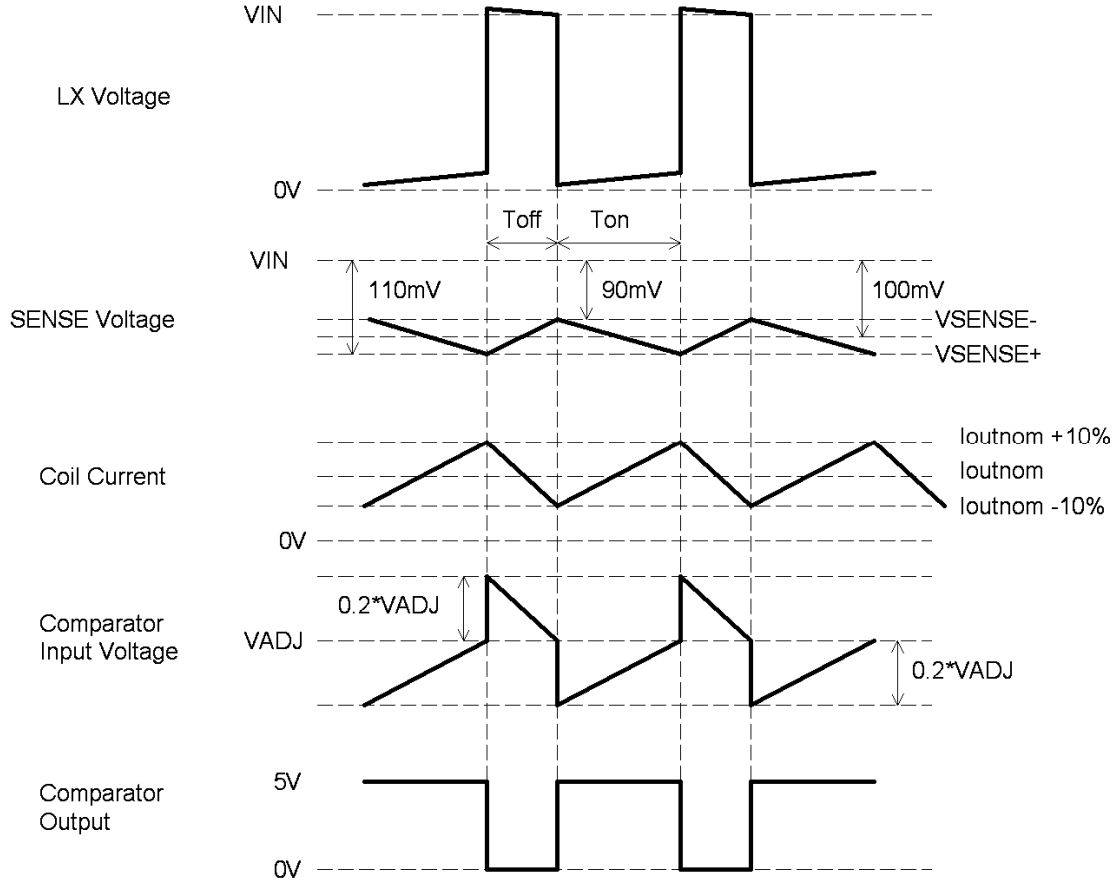

Figure 2. Theoretical Operating Waveforms

Operation can be best understood by assuming that the ADJ pin of the device is unconnected and the voltage on this pin (V_{ADJ}) appears directly at the (+) input of the comparator.

When input voltage V_{IN} is first applied, the initial current in L1 and R_S is zero and there is no output from the current sense circuit. Under this condition, the (-) input to the comparator is at ground and its output is high. This turns MN on and switches the LX pin low, causing current to flow from V_{IN} to ground, via R_S , L1 and the LED(s). The current rises at a rate determined by V_{IN} and L1 to produce a voltage ramp (V^{SENSE}) across R_S . The supply referred voltage V_{SENSE} is forced across internal resistor R1 by the current sense circuit and produces a proportional current in internal resistors R2 and R3. This produces a ground referred rising voltage at the (-) input of the

comparator. When this reaches the threshold voltage (V_{ADJ}), the comparator output switches low and MN turns off. The comparator output also drives another NMOS switch, which bypasses internal resistor R3 to provide a controlled amount of hysteresis. The hysteresis is set by R3 to be nominally 10% of V_{ADJ} .

When MN is off, the current in L1 continues to flow via D1 and the LED(s) back to V_{IN} . The current decays at a rate determined by the LED(s) and diode forward voltages to produce a falling voltage at the input of the comparator. When this voltage returns to V_{ADJ} , the comparator output switches high again. This cycle of events repeats, with the comparator input ramping between limits of $V_{ADJ} \pm 10\%$.

Device Description

Switching Thresholds

With $V_{ADJ} = V_{REF}$, the ratios of R1, R2 and R3 define an average V_{SENSE} switching threshold of 100mV (measured on the I_{SENSE} pin with respect to V_{IN}). The average output current I_{OUTnom} is then defined by this voltage and R_S according to:

$$I_{OUTnom} = 100mV/R_S$$

Nominal ripple current is $\pm 10mV/R_S$

Adjusting output current

The device contains a low pass filter between the ADJ pin and the threshold comparator and an internal current limiting resistor (50k Ω nom) between ADJ and the internal reference voltage. This allows the ADJ pin to be overdriven with either

DC or pulse signals to change the V_{SENSE} switching threshold and adjust the output current.

Details of the different modes of adjusting output current are given in the applications section.

Output Shutdown

The output of the low pass filter drives the shutdown circuit. When the input voltage to this circuit falls below the threshold (0.2V nom.), the internal regulator and the output switch are turned off. The voltage reference remains powered during shutdown to provide the bias current for the shutdown circuit. Quiescent supply current during shutdown is nominally 60 μ A and switch leakage is below 5 μ A.

Actual Operating Waveforms

$V_{IN} = 15V$, $R_S = 0.1V$, $L = 100\mu H$ Normal operation.
Output Current (Ch1) and LX Voltage (Ch2)

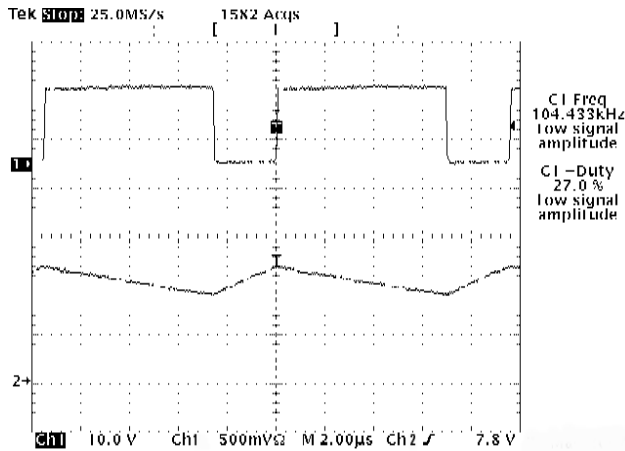

$V_{IN} = 30V$, $R_S = 0.1V$, $L = 100\mu H$ Normal Operation.
Output Current (Ch1) and LX Voltage (Ch2)

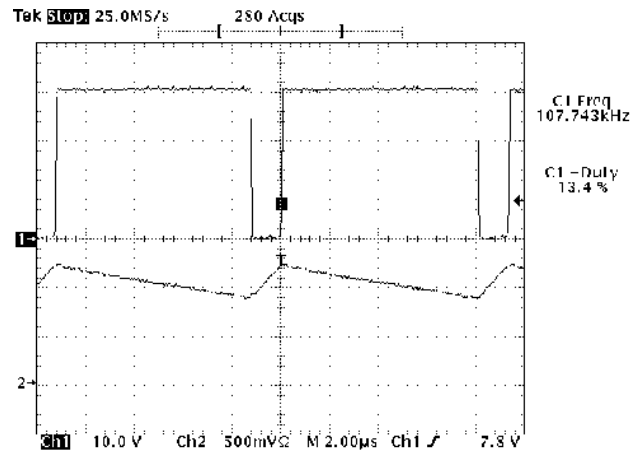

$V_{IN} = 60V$, $R_S = 0.1V$, $L = 100\mu H$ Normal Operation.
Output Current (Ch1) and LX Voltage (Ch2)

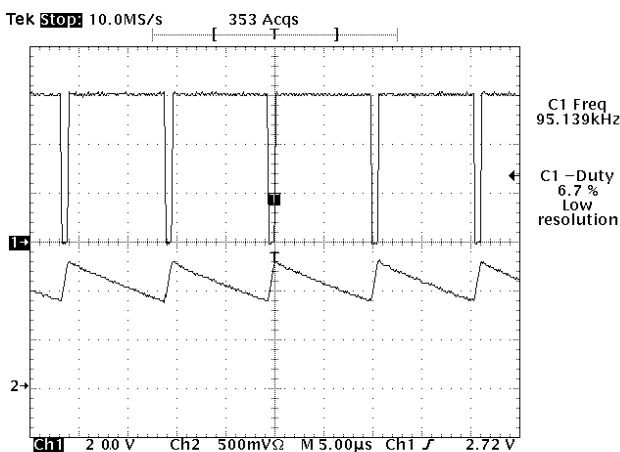

Typical Characteristics

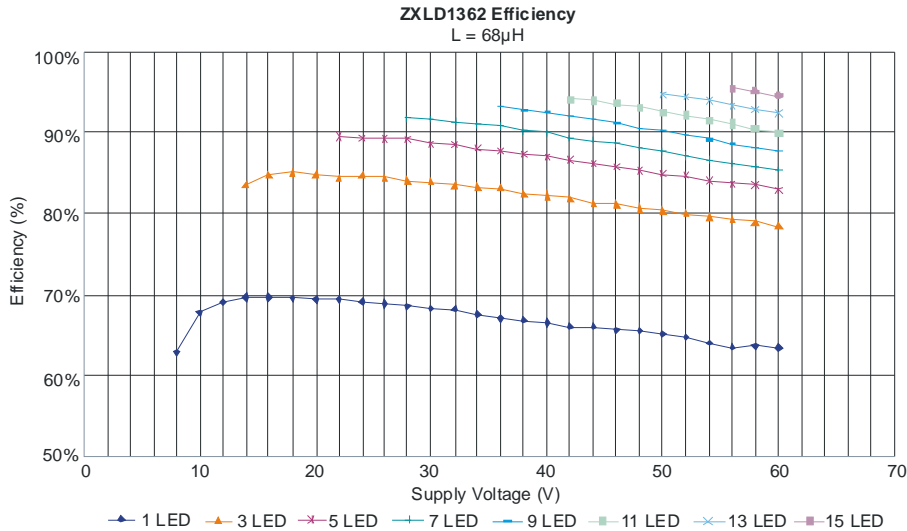
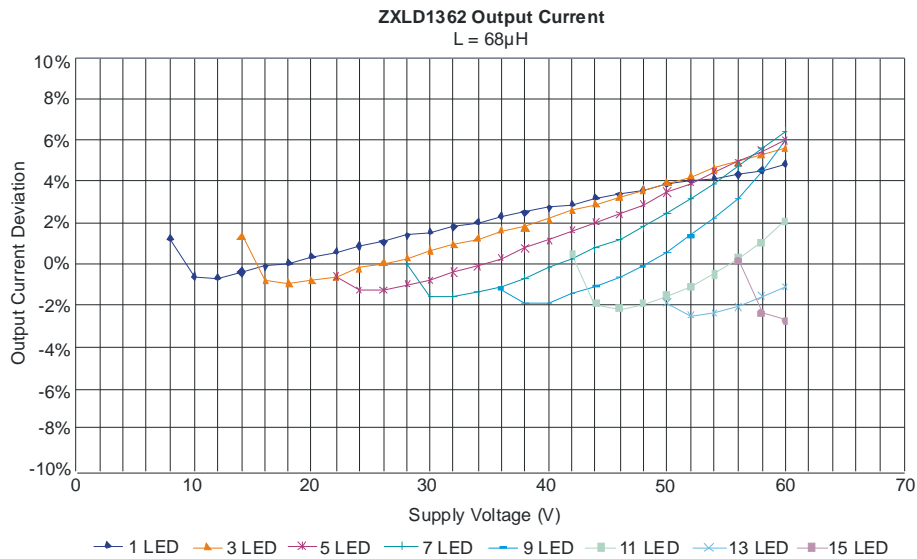
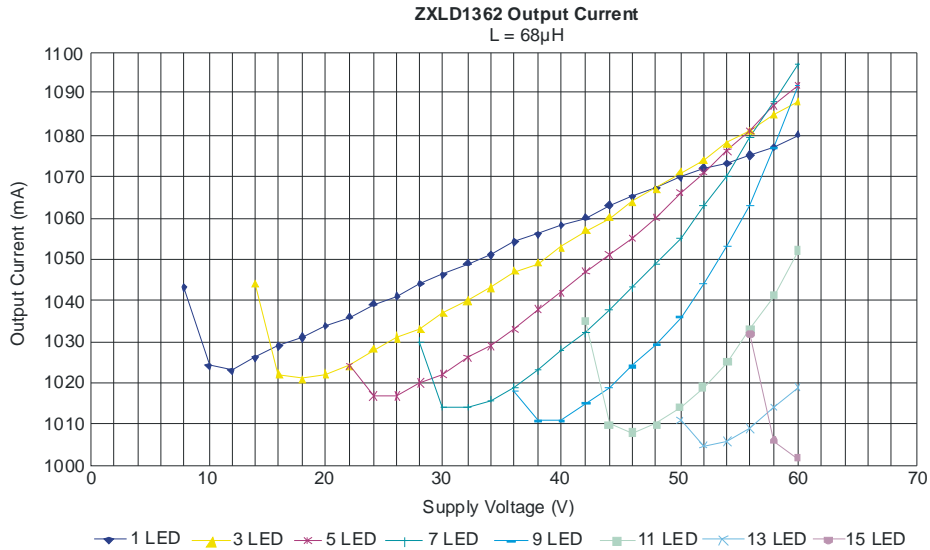

Typical Characteristics (cont.)

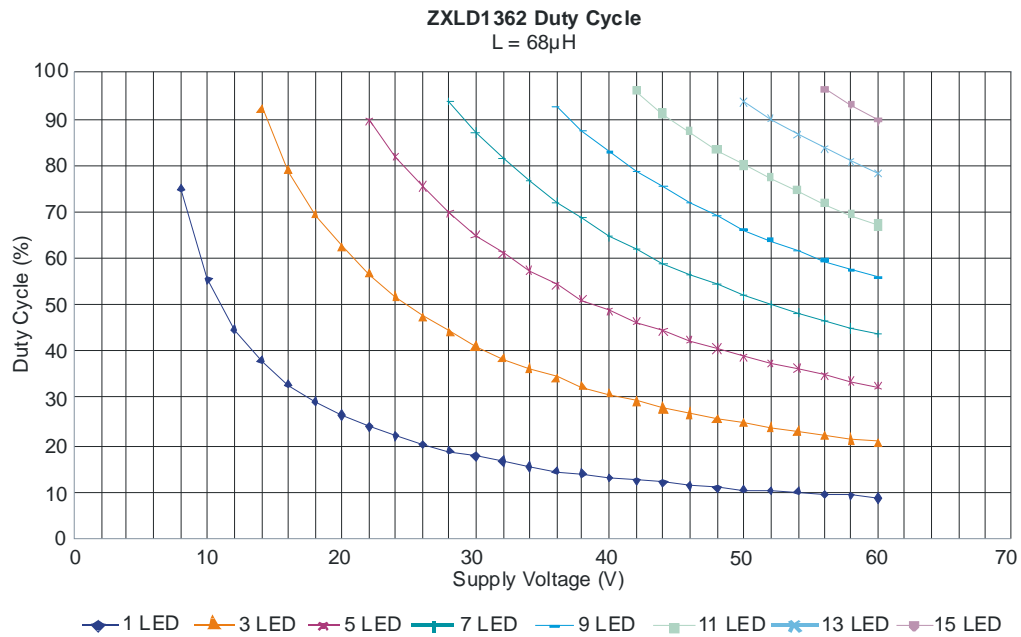
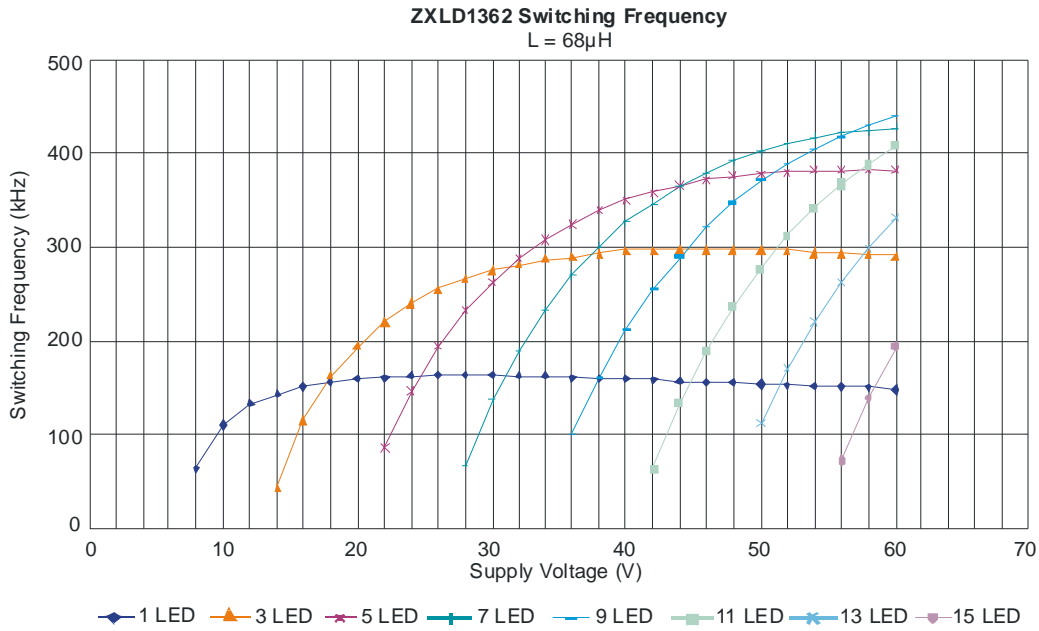

Typical Characteristics (cont.)

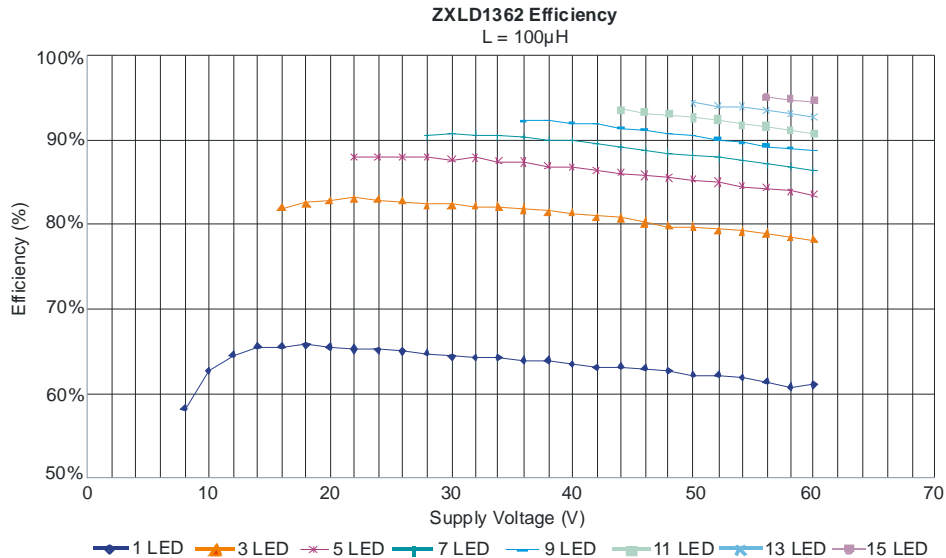
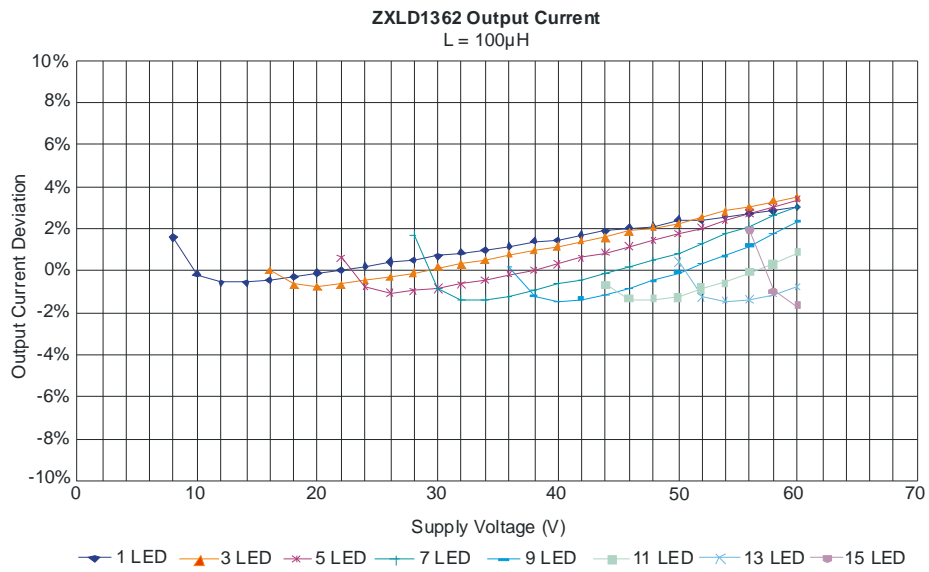
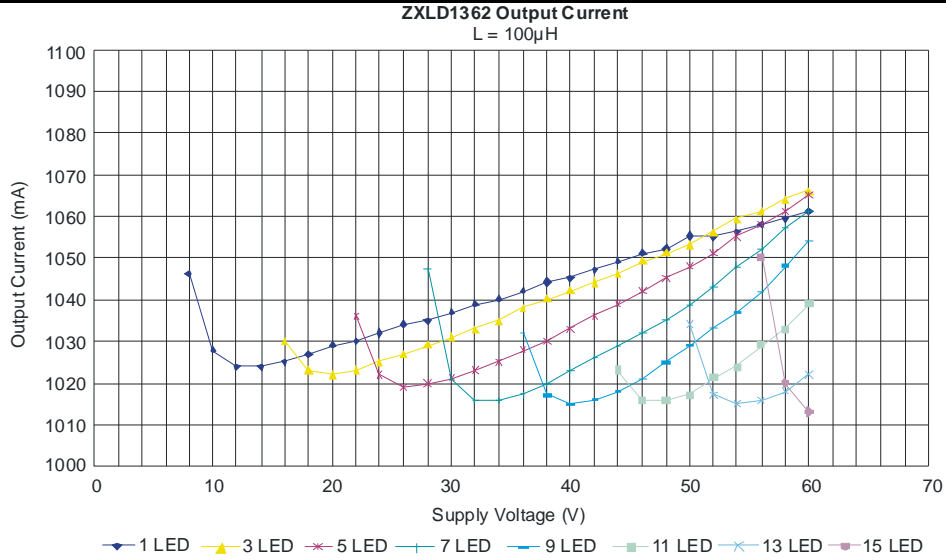

Typical Characteristics (cont.)

ZXLD1362 Switching Frequency
L = 100µH

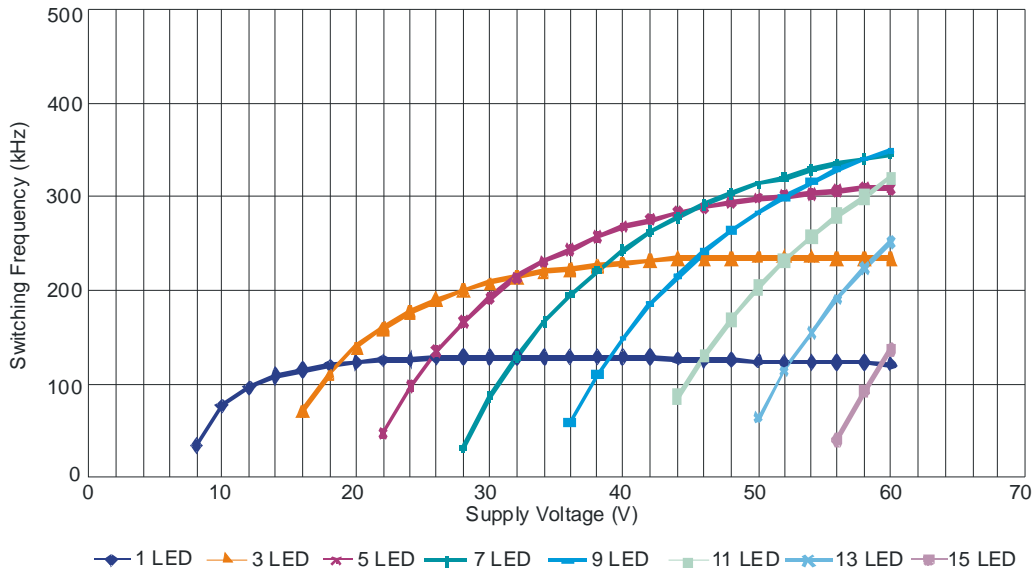

ZXLD1362 Switching Frequency
L = 100µH

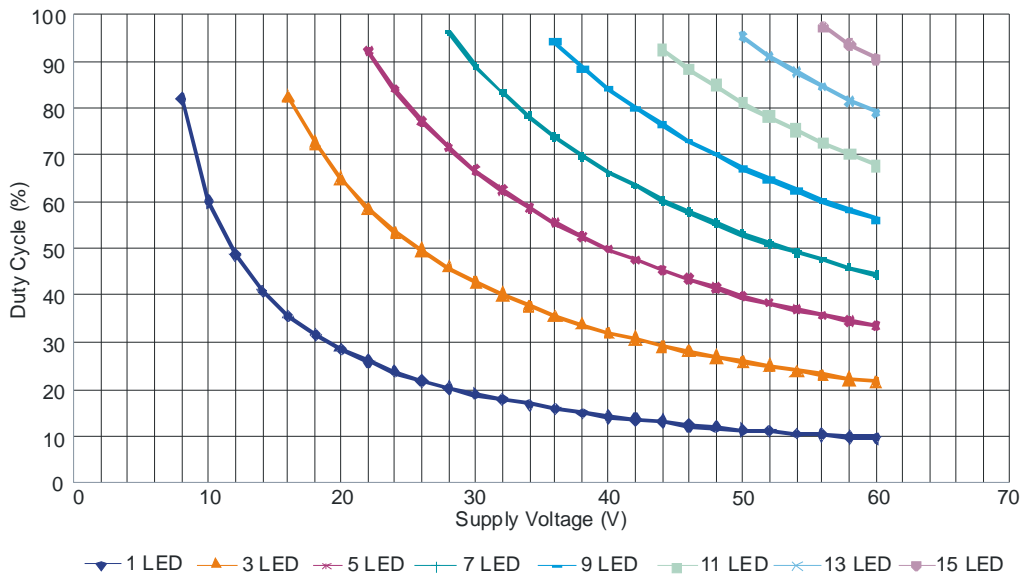

Typical Characteristics (cont.)

ZXLD1362 Output Current
L = 150µH

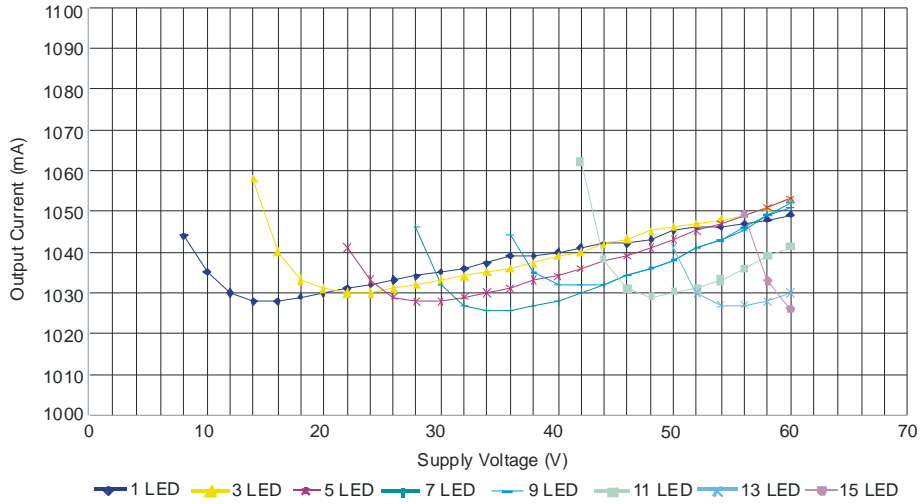

ZXLD1362 Output Current
L = 150µH

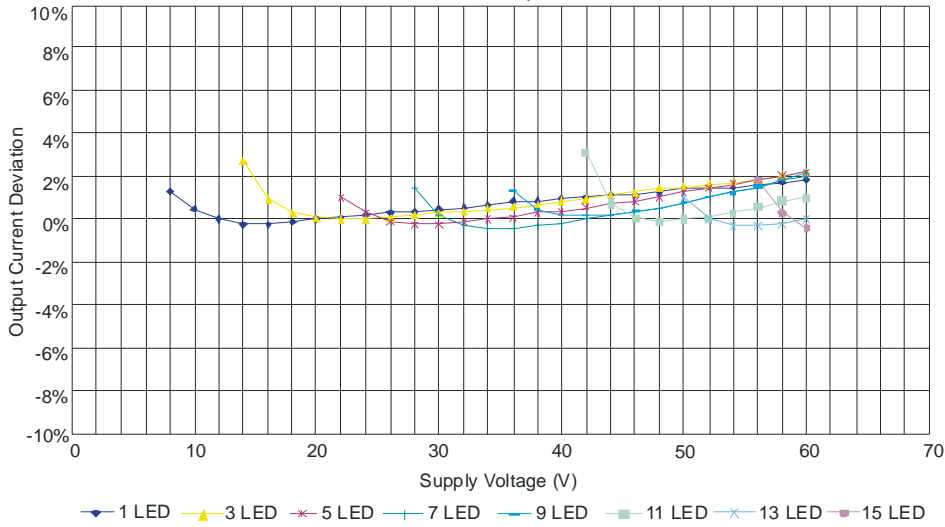

ZXLD1362 Efficiency
L = 150µH

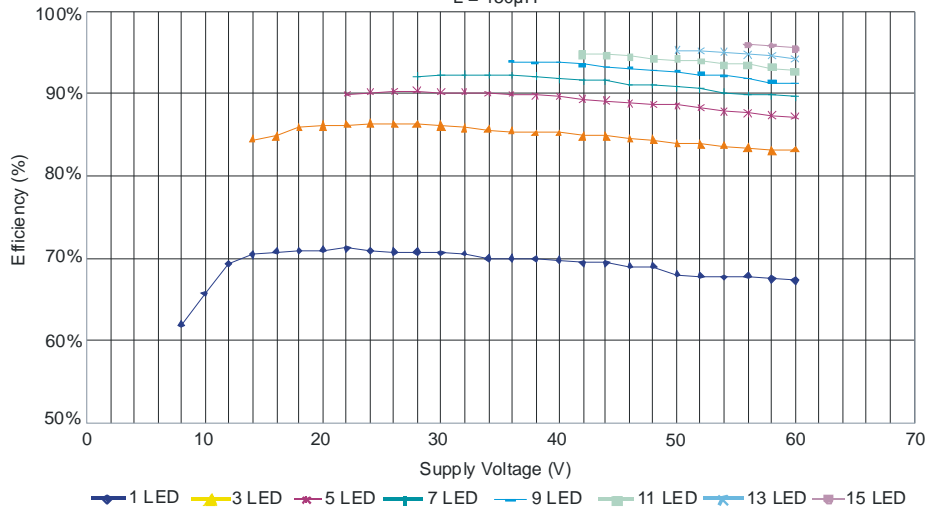

Typical Characteristics (cont.)

ZXLD1362 Switching Frequency
L = 150μH

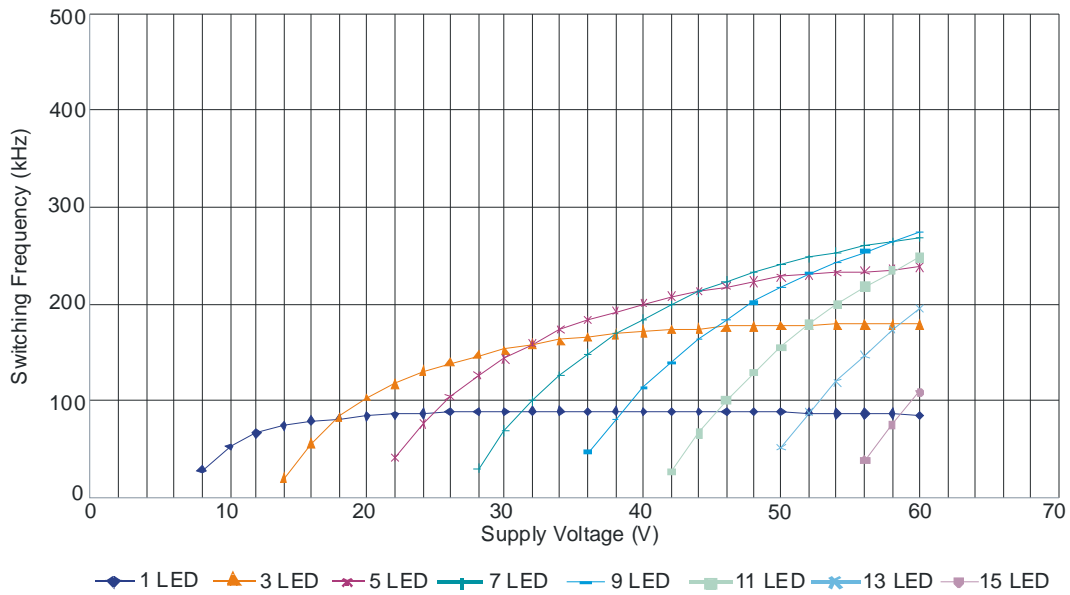

ZXLD1362 Duty Cycle
L = 150μH

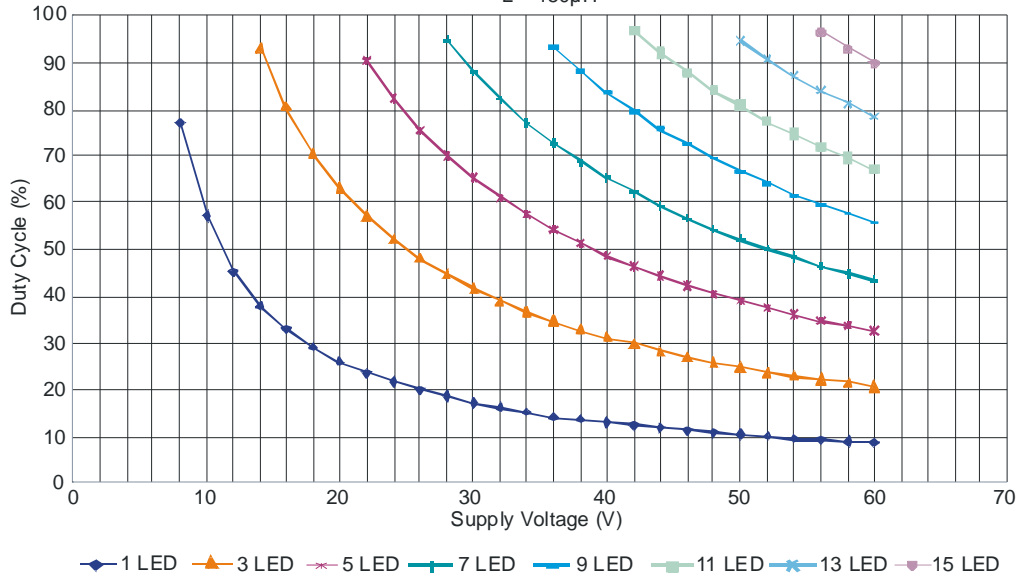

Typical Characteristics (cont.)

ZXLD1362 Output Current
L = 220μH

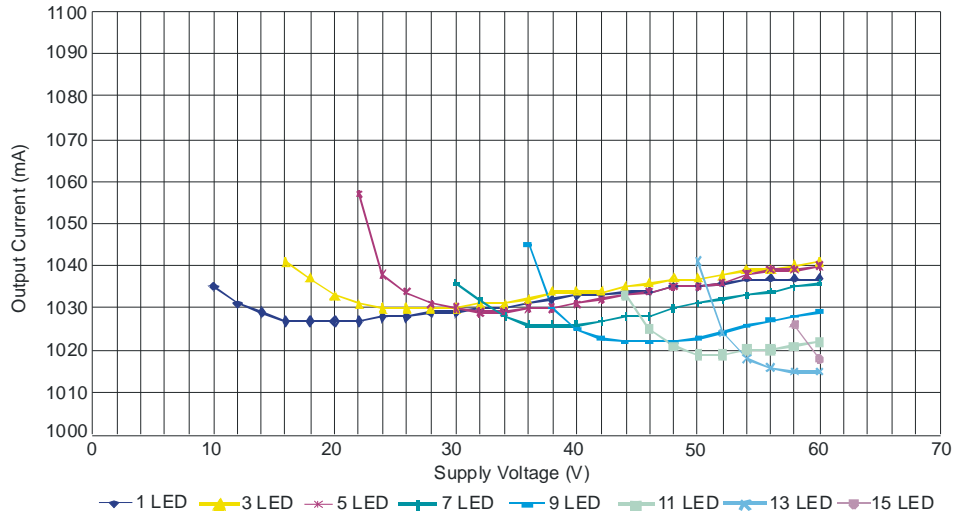

ZXLD1362 Output Current
L = 220μH

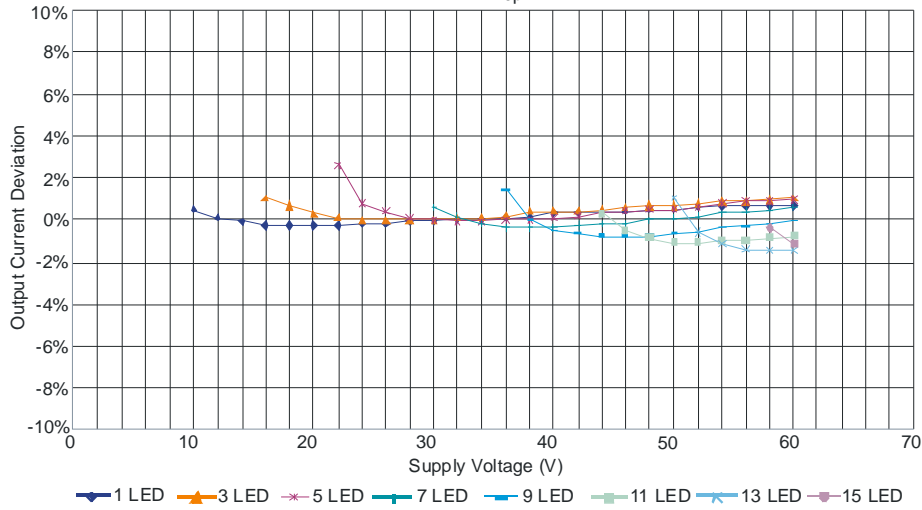

ZXLD1362 Efficiency
L = 220μH

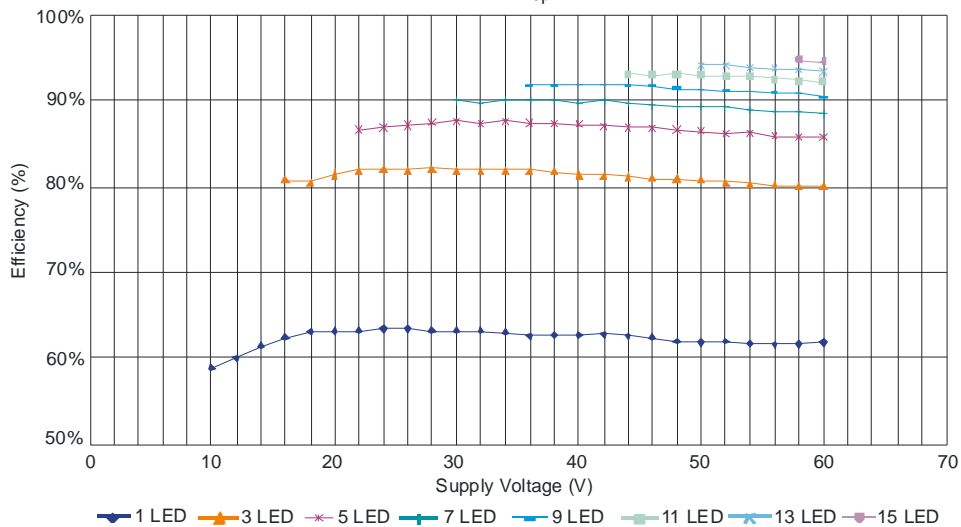

Typical Characteristics (cont.)

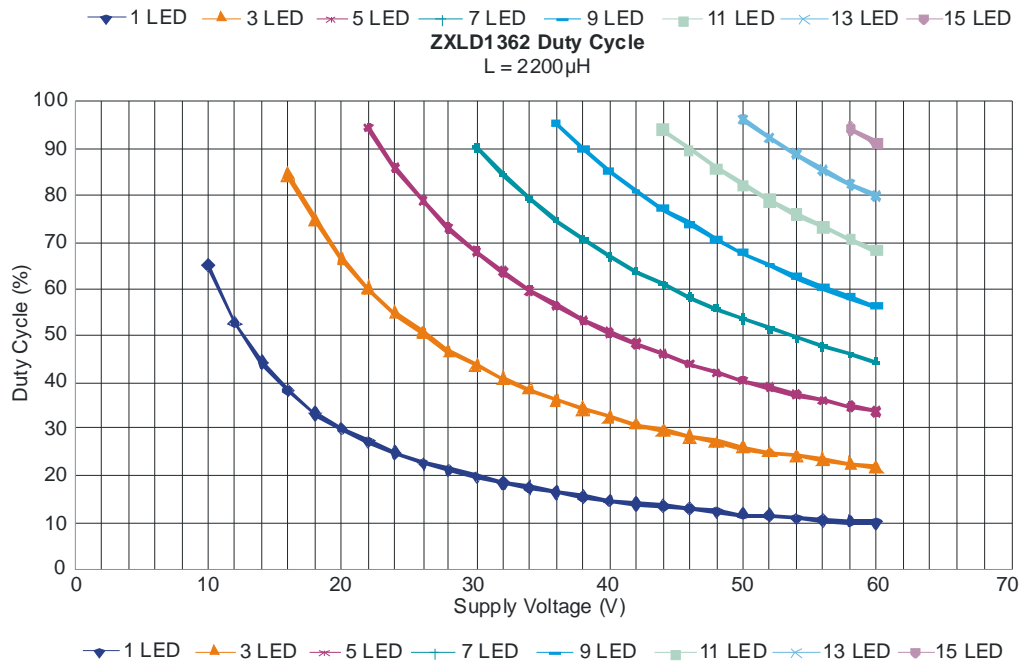
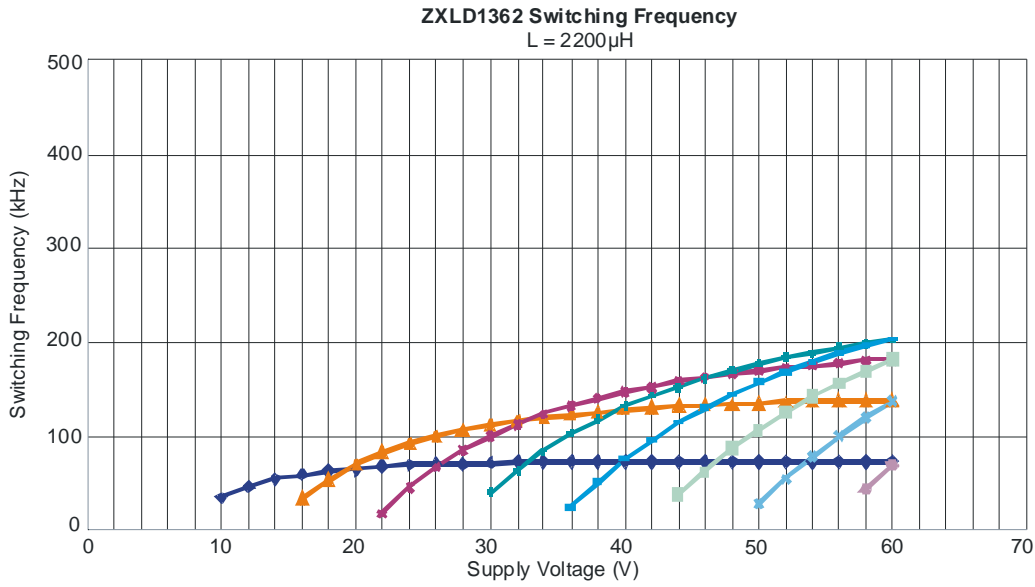

Typical Characteristics (cont.)

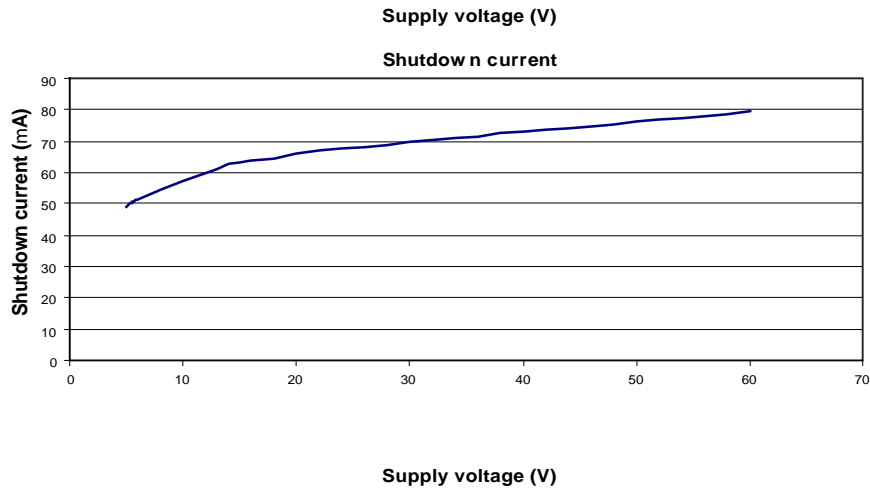
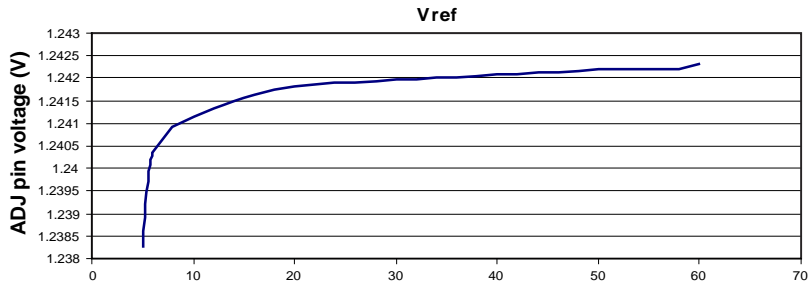
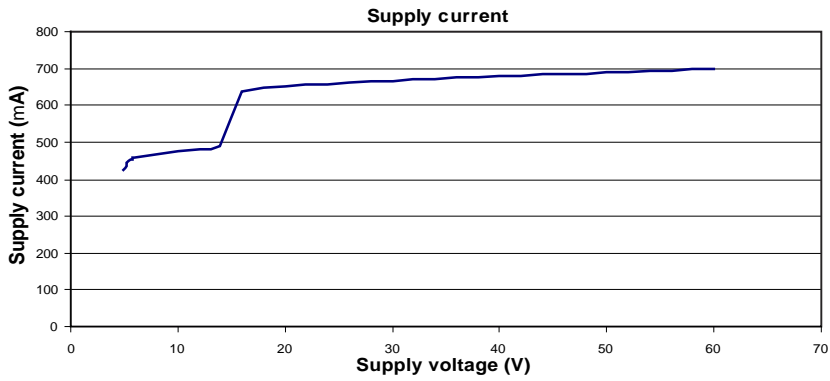
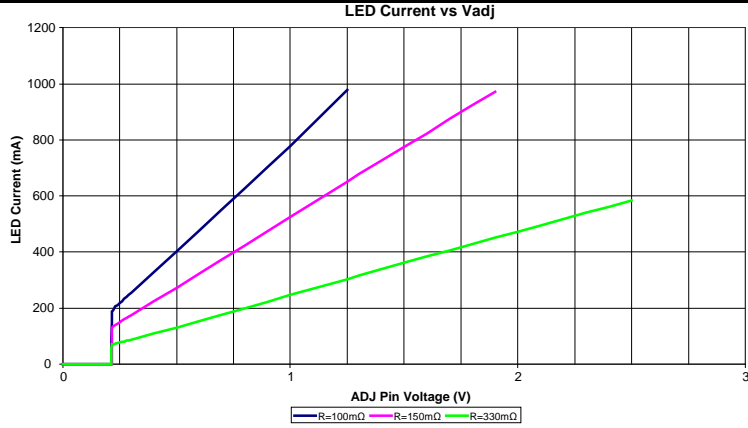

Typical Characteristics (cont.)

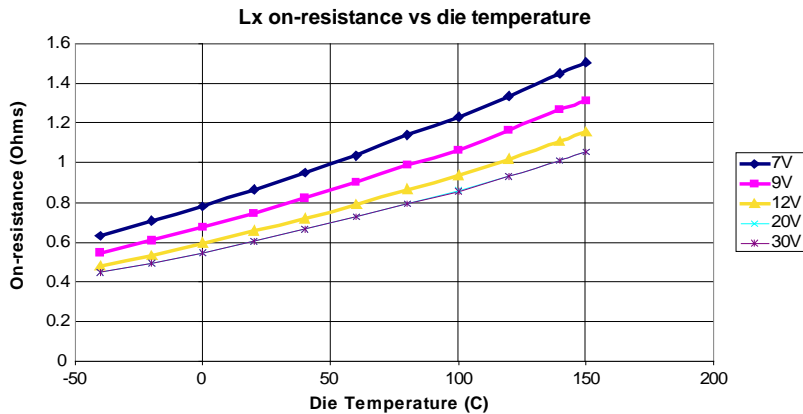
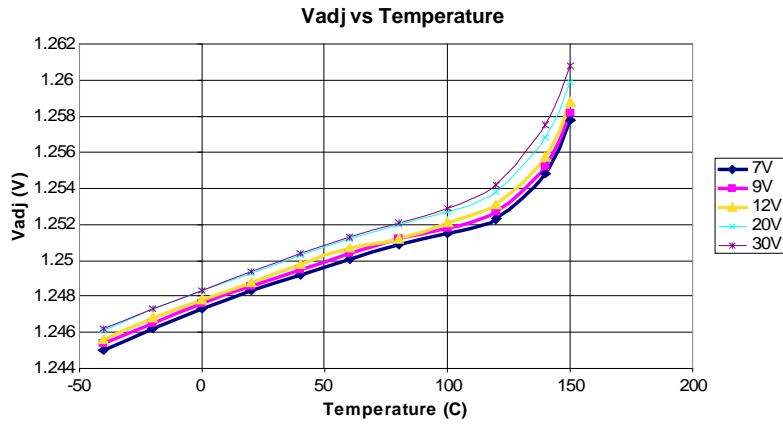
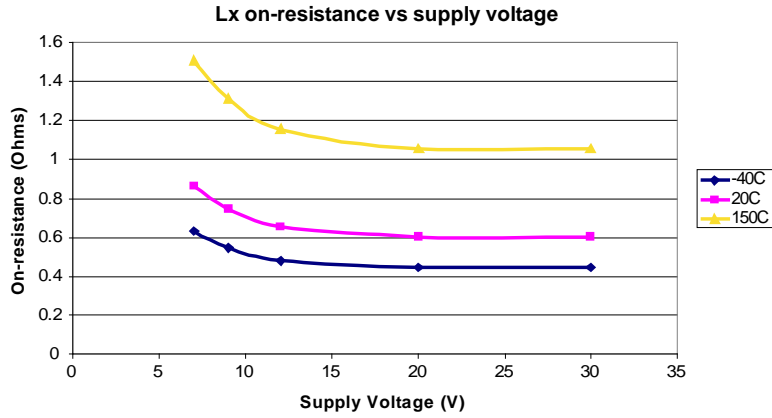

Application Information

Setting Nominal Average Output Current with External Resistor R_S

The nominal average output current in the LED(s) is determined by the value of the external current sense resistor (R_S) connected between V_{IN} and I_{SENSE} and is given by:

$$I_{OUTnom} = 0.1/R_S \text{ [for } R_S > 0.1\Omega\text{]}$$

The table below gives values of nominal average output current for several preferred values of current setting resistor (R_S) in the typical application circuit shown on page 1:

R_S (Ω)	Nominal average output current (mA)
0.1	1000
0.13	760
0.15	667

The above values assume that the ADJ pin is floating and at a nominal voltage of V_{REF} ($= 1.25V$). Note that $R_S = 0.1\Omega$ is the minimum allowed value of sense resistor under these conditions to maintain switch current below the specified maximum value.

It is possible to use different values of R_S if the ADJ pin is driven from an external voltage. (See next section).

Output Current Adjustment by External DC Control Voltage

The ADJ pin can be driven by an external dc voltage (V_{ADJ}), as shown, to adjust the output current to a value above or below the nominal average value defined by R_S .

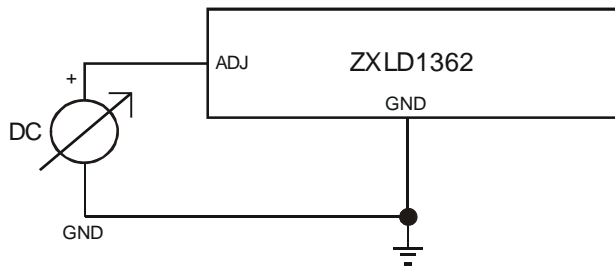

The nominal average output current in this case is given by:

$$I_{OUTdc} = (V_{ADJ} / 1.25) \times (100mV/R_S) \text{ [for } 0.3 < V_{ADJ} < 2.5V\text{]}$$

Note that 100% brightness setting corresponds to $V_{ADJ} = V_{REF}$. When driving the ADJ pin above 1.25V, R_S must be increased in proportion to prevent I_{OUTdc} exceeding 1A maximum.

The input impedance of the ADJ pin is $50k\Omega \pm 25\%$ for voltages below V_{REF} and $14.2k\Omega \pm 25\%$ for voltages above $V_{REF} + 100mV$.

Output Current Adjustment by PWM Control

Directly driving ADJ input

A Pulse Width Modulated (PWM) signal with duty cycle D_{PWM} can be applied to the ADJ pin, as shown below, to adjust the output current to a value above or below the nominal average value set by resistor R_S :

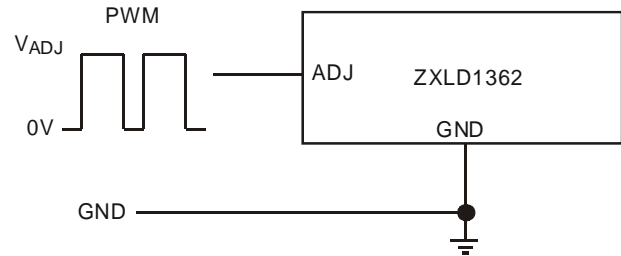

Driving the ADJ Input via Open Collector Transistor

The recommended method of driving the ADJ pin and controlling the amplitude of the PWM waveform is to use a small NPN switching transistor as shown below:

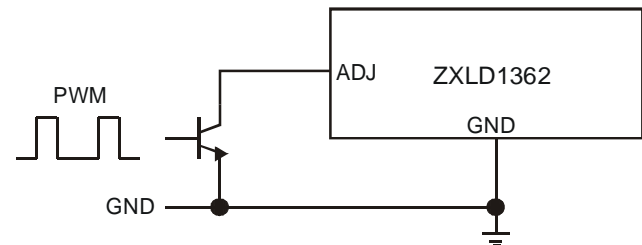

This scheme uses the 50k resistor between the ADJ pin and the internal voltage reference as a pull-up resistor for the external transistor.

Driving the ADJ Input from a Microcontroller

Another possibility is to drive the device from the open drain output of a microcontroller. The diagram below shows one method of doing this:

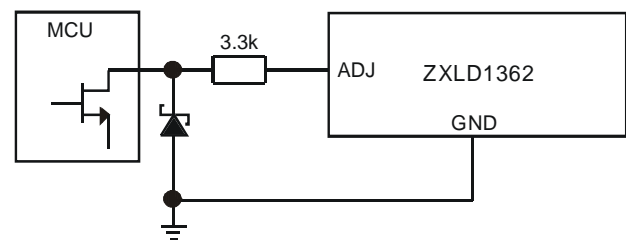

If the NMOS transistor within the microcontroller has high Gate / Drain capacitance, this arrangement can inject a negative spike into ADJ input of the 1362 and cause erratic operation but the addition of a Schottky clamp diode (cathode to ADJ) to ground and inclusion of a series resistor (3.3k) will prevent this. See the section on PWM dimming for more details of the various modes of control using high frequency and low frequency PWM signals.

Application Information (cont.)

Shutdown Mode

Taking the ADJ pin to a voltage below 0.2V for more than approximately 100 μ s will turn off the output and supply current to a low standby level of 20 μ A nominal.

Note that the ADJ pin is not a logic input. Taking the ADJ pin to a voltage above V_{REF} will increase output current above the 100% nominal average value. (See page 18 graphs for details).

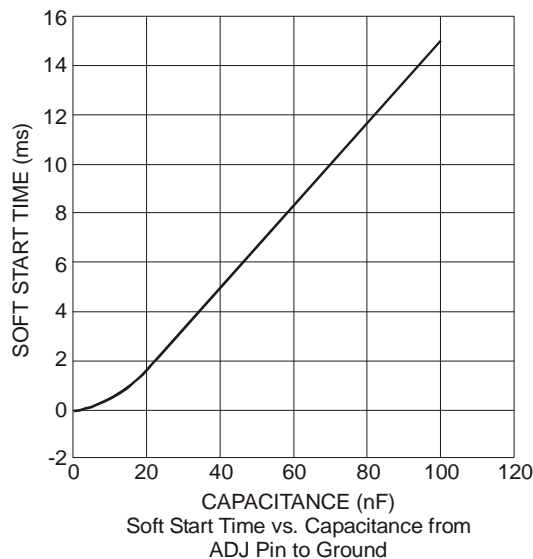

V_{IN} Capacitor Selection

A low ESR capacitor should be used for input decoupling, as the ESR of this capacitor appears in series with the supply source impedance and lowers overall efficiency. This capacitor has to supply the relatively high peak current to the coil and smooth the current ripple on the input supply.

To avoid transients into the IC, the size of the input capacitor will depend on the V_{IN} voltage:

$$V_{IN} = 6 \text{ to } 40\text{V } C_{IN} = 2.2\mu\text{F}$$

$$V_{IN} = 40 \text{ to } 50\text{V } C_{IN} = 4.7\mu\text{F}$$

$$V_{IN} = 50 \text{ to } 60\text{V } C_{IN} = 10\mu\text{F}$$

When the input voltage is close to the output voltage the input current increases which puts more demand on the input capacitor. The minimum value of 2.2 μ F may need to be increased to 4.7 μ F; higher values will improve performance at lower input voltages, especially when the source impedance is

Soft-Start

An external capacitor from the ADJ pin to ground will provide a soft-start delay, by increasing the time taken for the voltage on this pin to rise to the turn-on threshold and by slowing down the rate of rise of the control voltage at the input of the comparator. Adding capacitance increases this delay by approximately 200 μ s/nF. The graph to the left shows the variation of soft-start time for different values of capacitor.

Actual Operating Waveforms [$V_{IN} = 24\text{V}$, $R_S = 0.1\Omega$, $L = 68\mu\text{H}$, 22nF on ADJ]

Soft-start operation. Output current (Ch2) and LX voltage (Ch1)

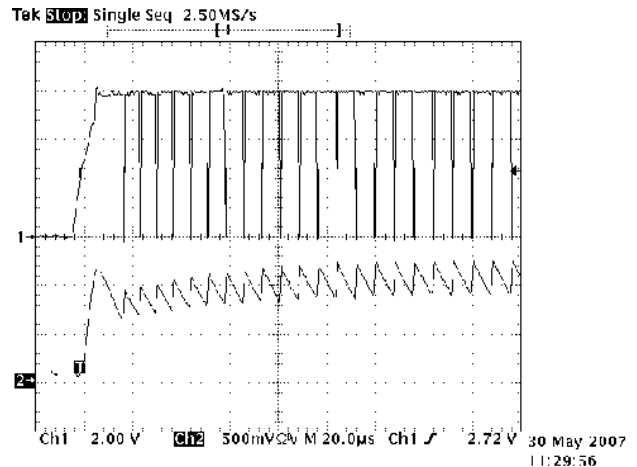

high. The input capacitor should be placed as close as possible to the IC.

For maximum stability over temperature and voltage, capacitors with X7R, X5R, or better dielectric is recommended. Capacitors with Y5V dielectric are not suitable for decoupling in this application and should **NOT** be used.

If higher voltages are used and the C_{IN} is 10 μ F. This can be an electrolytic capacitor provide a suitable 1 μ F ceramic capacitor is also used and positioned as close the V_{IN} of the IC as possible.

A suitable capacitor would be NACEW100M1006.3x8TR13F.

The following web sites are useful when finding alternatives:

www.murata.com

www.niccomp.com

www.kemet.com

Application Information (cont.)

Inductor Selection

Recommended inductor values for the ZXLD1362 are in the range 68 μ H to 220 μ H.

Higher values of inductance are recommended at higher supply voltages in order to minimize errors due to switching delays, which result in increased ripple and lower efficiency. Higher values of inductance also result in a smaller change in output current over the supply voltage range. (see graphs pages 10 - 17). The inductor should be mounted as close to the device as possible with low resistance connections to the LX and V_{IN} pins.

The chosen coil should have a saturation current higher than the peak output current and a continuous current rating above the required mean output current.

Suitable coils for use with the ZXLD1362 may be selected from the MSS range manufactured by Coilcraft, or the NPIS range

manufactured by NIC components. The following websites may be useful in finding suitable components.

www.coilcraft.com

www.niccomp.com

www.wuerth-elektronik.de

The inductor value should be chosen to maintain operating duty cycle and switch 'on'/off times within the specified limits over the supply voltage and load current range.

The graph Figure 3 below can be used to select a recommended inductor based on maintaining the ZXLD1362 case temperature below 60°C. For detailed performance characteristics for the inductor values 68, 100, 150 and 220 μ H see graphs on pages 10-17.

ZXLD1362 Minimum Recommended Inductor

Aluminium board, 2% Accuracy, -60°C Case Temperature

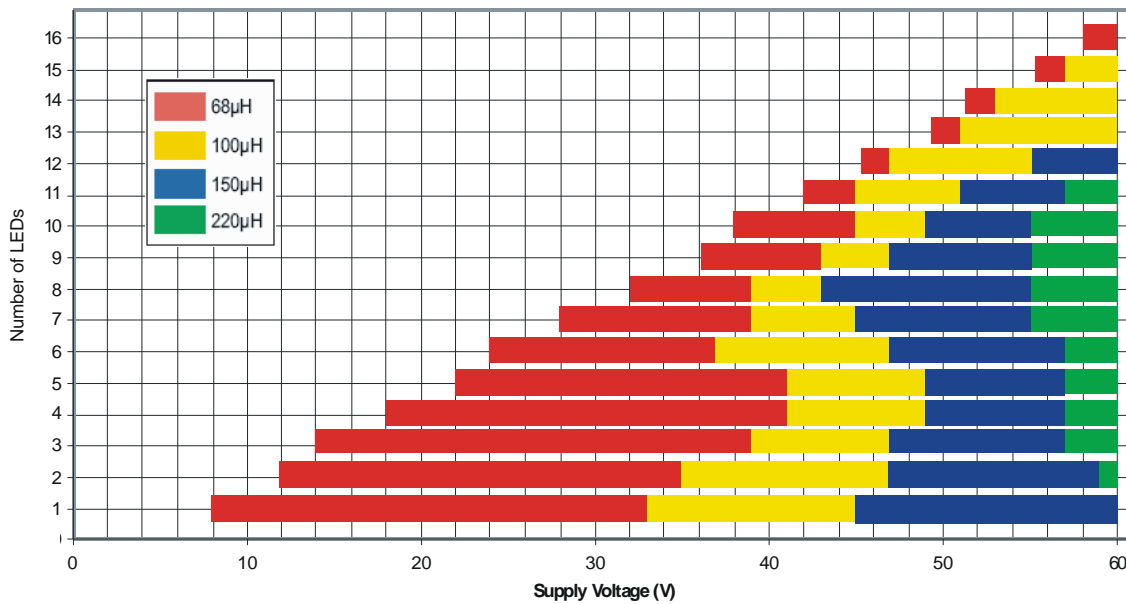

Figure 3. ZXLD1362 Minimum Recommended Inductor

Application Information (cont.)

Diode Selection

For maximum efficiency and performance, the rectifier (D1) should be a fast low capacitance Schottky diode* with low reverse leakage at the maximum operating voltage and temperature.

They also provide better efficiency than silicon diodes, due to a combination of lower forward voltage and reduced recovery time.

It is important to select parts with a peak current rating above the peak coil current and a continuous current rating higher than the maximum output load current. It is very important to consider the reverse leakage of the diode when operating above +85°C. Excess leakage will increase the power

dissipation in the device and if close to the load may create a thermal runaway condition.

The higher forward voltage and overshoot due to reverse recovery time in silicon diodes will increase the peak voltage on the LX output. If a silicon diode is used, care should be taken to ensure that the total voltage appearing on the LX pin including supply ripple, does not exceed the specified maximum value.

*A suitable Schottky diode would be 30BQ100PBF (IR).

Reducing Output Ripple

Peak to peak ripple current in the LED(s) can be reduced, if required, by shunting a capacitor C_{led} across the LED(s) as shown below:

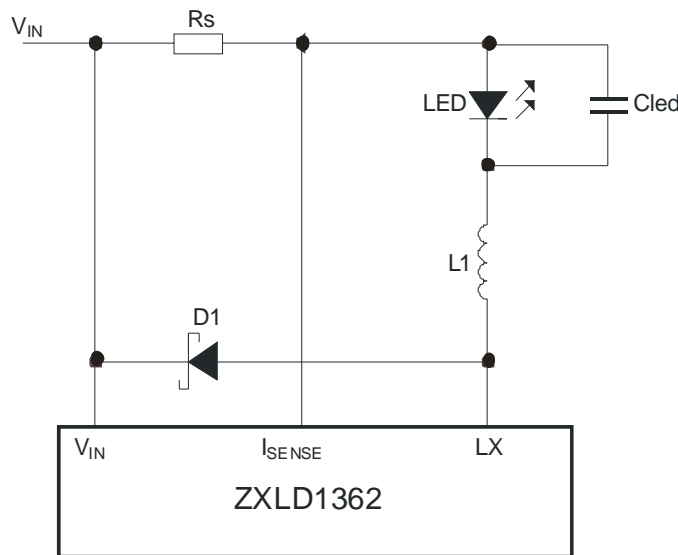

A value of $1\mu\text{F}$ will reduce the supply ripple current by a factor three (approx.). Proportionally lower ripple can be achieved with higher capacitor values. Note that the capacitor will not affect operating frequency or efficiency, but it will increase start-up delay, by reducing the rate of rise of LED voltage.

By adding this capacitor the current waveform through the LED(s) changes from a triangular ramp to a more sinusoidal version without altering the mean current value.

Operation at Low Supply Voltage

Below the under-voltage lockout threshold (VSD) the drive to the output transistor is turned off to prevent device operation

with excessive on-resistance of the output transistor. The output transistor is not full enhanced until the supply voltage exceeds approximately 17V. At supply voltages between V_{SD} and 17V care must be taken to avoid excessive power dissipation due to the on-resistance.

If the supply voltage is always less than 30V continuous an alternative device is available, the ZXLD1360 or the AL8805.

Note that when driving loads of two or more LEDs, the forward drop will normally be sufficient to prevent the device from switching below approximately 6V. This will minimize the risk of damage to the device.

Application Information (cont.)

Thermal Considerations

When operating the device at high ambient temperatures, or when driving maximum load current, care must be taken to avoid exceeding the package power dissipation limits. The

graph below gives details for power derating. This assumes the device to be mounted on a 25mm² PCB with 1oz copper standing in still air.

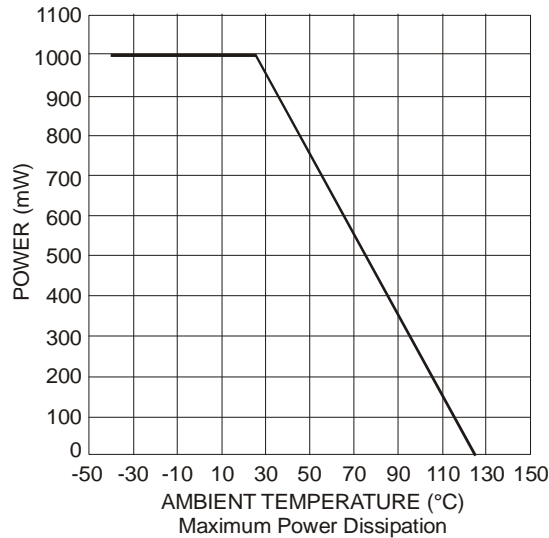

Note that the device power dissipation will most often be a maximum at minimum supply voltage. It will also increase if the efficiency of the circuit is low. This may result from the use of unsuitable coils, or excessive parasitic output capacitance on the switch output.

Thermal Compensation of Output Current

High luminance LEDs often need to be supplied with a temperature compensated current in order to maintain stable and reliable operation at all drive levels. The LEDs are usually mounted remotely from the device so, for this reason, the temperature coefficients of the internal circuits for the ZXLD1362 have been optimized to minimize the change in output current when no compensation is employed. If output current compensation is required, it is possible to use an external temperature sensing network - normally using Negative Temperature Coefficient (NTC) thermistors and/or diodes, mounted very close to the LED(s). The output of the sensing network can be used to drive the ADJ pin in order to reduce output current with increasing temperature.

Layout Considerations

LX Pin

The LX pin of the device is a fast switching node, so PCB tracks should be kept as short as possible. To minimize ground 'bounce', the ground pin of the device should be soldered directly to the ground plane.

Coil and Decoupling Capacitors and Current Sense Resistor

It is particularly important to mount the coil and the input decoupling capacitor as close to the device pins as possible to minimize parasitic resistance and inductance, which will degrade efficiency. It is also important to minimize any track resistance in series with current sense resistor R_S . Its best to connect V_{IN} directly to one end of R_S and I_{SENSE} directly to the opposite end of R_S with no other currents flowing in these tracks. It is important that the cathode current of the Schottky diode does not flow in a track between R_S and V_{IN} as this may give an apparent higher measure of current than is actual because of track resistance.

Application Information (cont.)

ADJ Pin

The ADJ pin is a high impedance input for voltages up to 1.35V so, when left floating, PCB tracks to this pin should be as short as possible to reduce noise pickup. A 100nF capacitor from the ADJ pin to ground will reduce frequency modulation of the output under these conditions. An additional series 3.3kΩ resistor can also be used when driving the ADJ pin from an external circuit (see below). This resistor will provide filtering for low frequency noise and provide protection against high voltage transients.

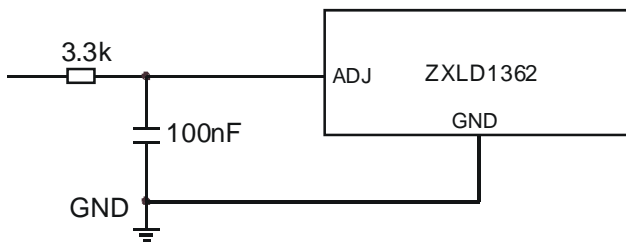

High Voltage Tracks

Avoid running any high voltage tracks close to the ADJ pin, to reduce the risk of leakage currents due to board contamination. The ADJ pin is soft-clamped for voltages above 1.35V to desensitize it to leakage that might raise the ADJ pin voltage and cause excessive output current. However, a ground ring placed around the ADJ pin is recommended to minimize changes in output current under these conditions.

Evaluation PCB

ZXLD1362 evaluation boards are available on request and provide quick testing of the ZXLD1362 device.

Dimming Output Current Using PWM

Low Frequency PWM Mode

When the ADJ pin is driven with a low frequency PWM signal (eg 100Hz), with a high level voltage V_{ADJ} and a low level of zero, the output of the internal low pass filter will swing between 0V and V_{ADJ} , causing the input to the shutdown circuit to fall below its turn-off threshold (200mV nom) when the ADJ pin is low. This will cause the output current to be switched on and off at the PWM frequency, resulting in an average output current I_{OUTavg} proportional to the PWM duty cycle.

(See Figure 4 - Low frequency PWM operating waveforms).

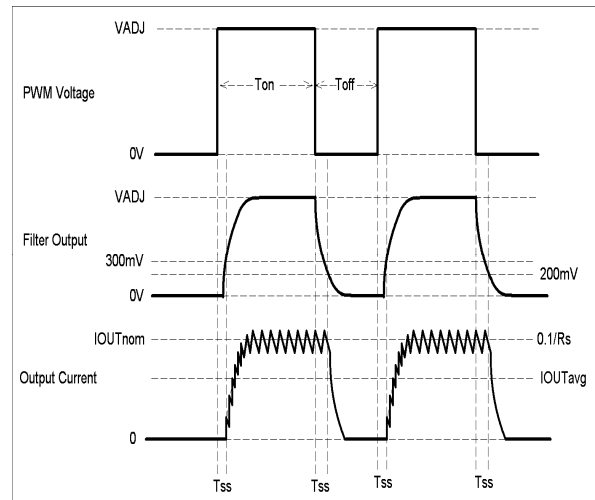

Figure 4. Low Frequency PWM Operating Waveforms

The average value of output current in this mode is given by:

$$I_{OUTavg} = 0.1D_{PWM}/R_S \text{ [for } D_{PWM} > 0.001\text{]}$$

This mode is preferable if optimum LED 'whiteness' is required. It will also provide the widest possible dimming range (approx. 1000:1) and higher efficiency at the expense of greater output ripple.

Ordering Information

Device	Part Mark	Package Code	Packaging (Note 11)	Reel size (mm)	Reel width (mm)	Quantity per reel	Part Number Suffix	AEC-Q100 grade
ZXLD1362ET5TA	1362	ET5	TSOT25	180	8	3000	TA	1

Note: 11. Pad layout as shown on Diodes Inc. suggested pad layout document AP02001, which can be found on our website at <http://www.diodes.com/datasheets/ap02001.pdf>.

Package Outline Dimensions

TSOT25

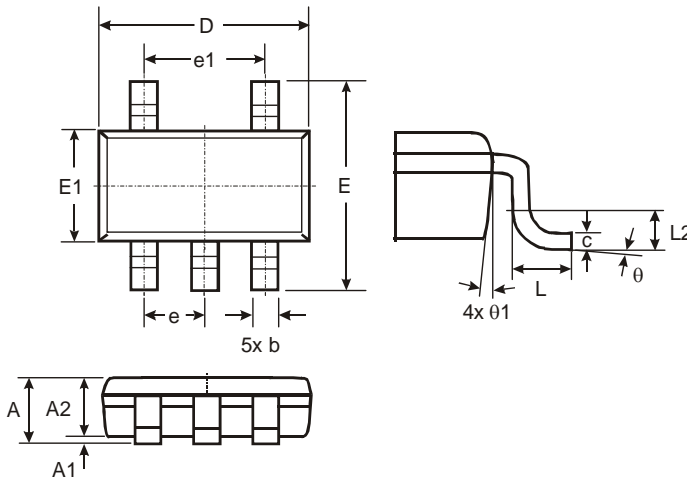

TSOT25			
Dim	Min	Max	Typ
A	–	1.00	–
A1	0.01	0.10	–
A2	0.84	0.90	–
D	–	–	2.90
E	–	–	2.80
E1	–	–	1.60
b	0.30	0.45	–
c	0.12	0.20	–
e	–	–	0.95
e1	–	–	1.90
L	0.30	0.50	–
L2	–	–	0.25
θ	0°	8°	4°
θ1	4°	12°	–
All Dimensions in mm			

Suggested Pad Layout

TSOT25

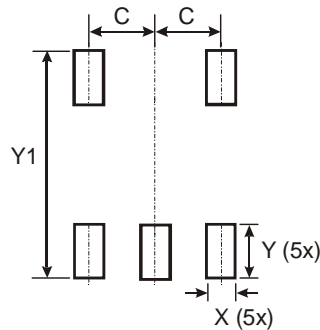

Dimensions	Value (in mm)
C	0.950
X	0.700
Y	1.000
Y1	3.199

IMPORTANT NOTICE

DIODES INCORPORATED MAKES NO WARRANTY OF ANY KIND, EXPRESS OR IMPLIED, WITH REGARDS TO THIS DOCUMENT, INCLUDING, BUT NOT LIMITED TO, THE IMPLIED WARRANTIES OF MERCHANTABILITY AND FITNESS FOR A PARTICULAR PURPOSE (AND THEIR EQUIVALENTS UNDER THE LAWS OF ANY JURISDICTION).

Diodes Incorporated and its subsidiaries reserve the right to make modifications, enhancements, improvements, corrections or other changes without further notice to this document and any product described herein. Diodes Incorporated does not assume any liability arising out of the application or use of this document or any product described herein; neither does Diodes Incorporated convey any license under its patent or trademark rights, nor the rights of others. Any Customer or user of this document or products described herein in such applications shall assume all risks of such use and will agree to hold Diodes Incorporated and all the companies whose products are represented on Diodes Incorporated website, harmless against all damages.

Diodes Incorporated does not warrant or accept any liability whatsoever in respect of any products purchased through unauthorized sales channel.

Should Customers purchase or use Diodes Incorporated products for any unintended or unauthorized application, Customers shall indemnify and hold Diodes Incorporated and its representatives harmless against all claims, damages, expenses, and attorney fees arising out of, directly or indirectly, any claim of personal injury or death associated with such unintended or unauthorized application.

Products described herein may be covered by one or more United States, international or foreign patents pending. Product names and markings noted herein may also be covered by one or more United States, international or foreign trademarks.

LIFE SUPPORT

Diodes Incorporated products are specifically not authorized for use as critical components in life support devices or systems without the express written approval of the Chief Executive Officer of Diodes Incorporated. As used herein:

A. Life support devices or systems are devices or systems which:

1. are intended to implant into the body, or
2. support or sustain life and whose failure to perform when properly used in accordance with instructions for use provided in the labeling can be reasonably expected to result in significant injury to the user.

B. A critical component is any component in a life support device or system whose failure to perform can be reasonably expected to cause the failure of the life support device or to affect its safety or effectiveness.

Customers represent that they have all necessary expertise in the safety and regulatory ramifications of their life support devices or systems, and acknowledge and agree that they are solely responsible for all legal, regulatory and safety-related requirements concerning their products and any use of Diodes Incorporated products in such safety-critical, life support devices or systems, notwithstanding any devices- or systems-related information or support that may be provided by Diodes Incorporated. Further, Customers must fully indemnify Diodes Incorporated and its representatives against any damages arising out of the use of Diodes Incorporated products in such safety-critical, life support devices or systems.

Copyright © 2012, Diodes Incorporated

www.diodes.com

Компания «Океан Электроники» предлагает заключение долгосрочных отношений при поставках импортных электронных компонентов на взаимовыгодных условиях!

Наши преимущества:

- Поставка оригинальных импортных электронных компонентов напрямую с производств Америки, Европы и Азии, а так же с крупнейших складов мира;
- Широкая линейка поставок активных и пассивных импортных электронных компонентов (более 30 млн. наименований);
- Поставка сложных, дефицитных, либо снятых с производства позиций;
- Оперативные сроки поставки под заказ (от 5 рабочих дней);
- Экспресс доставка в любую точку России;
- Помощь Конструкторского Отдела и консультации квалифицированных инженеров;
- Техническая поддержка проекта, помощь в подборе аналогов, поставка прототипов;
- Поставка электронных компонентов под контролем ВП;
- Система менеджмента качества сертифицирована по Международному стандарту ISO 9001;
- При необходимости вся продукция военного и аэрокосмического назначения проходит испытания и сертификацию в лаборатории (по согласованию с заказчиком);
- Поставка специализированных компонентов военного и аэрокосмического уровня качества (Xilinx, Altera, Analog Devices, Intersil, Interpoint, Microsemi, Actel, Aeroflex, Peregrine, VPT, Syfer, Eurofarad, Texas Instruments, MS Kennedy, Miteq, Cobham, E2V, MA-COM, Hittite, Mini-Circuits, General Dynamics и др.);

Компания «Океан Электроники» является официальным дистрибьютором и эксклюзивным представителем в России одного из крупнейших производителей разъемов военного и аэрокосмического назначения «JONHON», а так же официальным дистрибьютором и эксклюзивным представителем в России производителя высокотехнологичных и надежных решений для передачи СВЧ сигналов «FORSTAR».



JONHON

«JONHON» (основан в 1970 г.)

Разъемы специального, военного и аэрокосмического назначения:

(Применяются в военной, авиационной, аэрокосмической, морской, железнодорожной, горно- и нефтедобывающей отраслях промышленности)

«FORSTAR» (основан в 1998 г.)

ВЧ соединители, коаксиальные кабели, кабельные сборки и микроволновые компоненты:

(Применяются в телекоммуникациях гражданского и специального назначения, в средствах связи, РЛС, а так же военной, авиационной и аэрокосмической отраслях промышленности).



Телефон: 8 (812) 309-75-97 (многоканальный)

Факс: 8 (812) 320-03-32

Электронная почта: ocean@oceanchips.ru

Web: <http://oceanchips.ru/>

Адрес: 198099, г. Санкт-Петербург, ул. Калинина, д. 2, корп. 4, лит. А