

## 3KP-G Series

**Stand-off Voltage: 5.0 ~ 440V**  
**Power Dissipation: 3000 Watts**  
**RoHS Device**

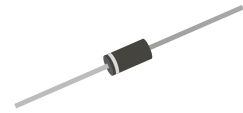

### Features

- Glass passivated chip.
- Low leakage.
- Uni and Bidirection unit.
- Excellent clamping capability.
- Very Fast response time.

### Mechanical Data

- Case: Molded plastic R-6
- Epoxy: UL 94V-0 rate flame retardant.
- Lead: Solderable per MIL-STD-202, method 208 guranteed.
- Polarity: Color band denotes cathode end except Bipolar.
- Weight: 2.1 grams

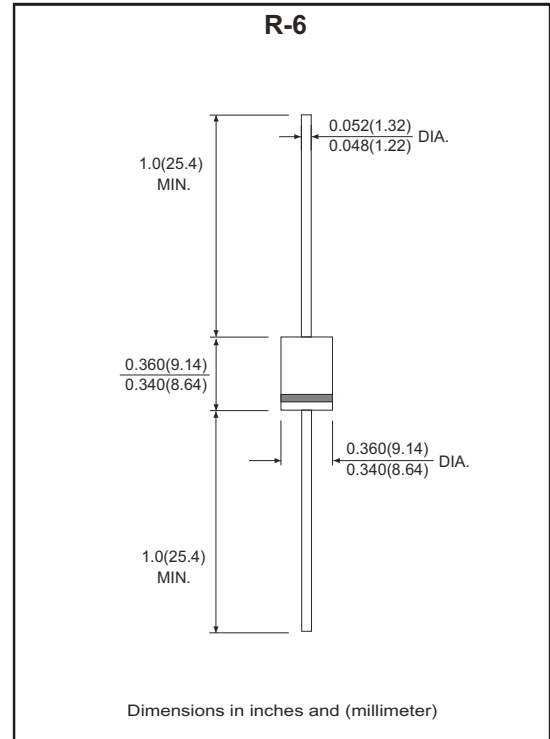

### Maximum Ratings and Electrical Characteristics

Rating at 25°C ambient temperature unless otherwise specified.  
 Single phase, half wave, 60Hz, resistive or inductive loaded.  
 For capacitive load, derated current by 20%.

Parameter	Symbol	Value	Unit
Peak power dissipation with a 10/1000 $\mu$ s waveform (Note 1)	PPP	3000	W
Peak pulse current with a 10/1000 $\mu$ s waveform (Note 1)	IPP	See Next Table	A
Power dissipation on infinite heatsink at $T_L=75^\circ\text{C}$	PD	6.5	W
Peak forward surge current, 8.3ms single half sine-wave unidirectional only (Note 2)	IFSM	300	A
Maximum instantaneous forward voltage at 100A for unidirectional only (Note 3)	V <sub>F</sub>	3.5 / 5.0	V
Operating junction and storage temperature range	T <sub>J</sub> , T <sub>STG</sub>	-55 to +150	°C

NTOES:

- (1) Non-repetitive current pulse, per fig.3 and derated above  $T_A=25^\circ\text{C}$  per Fig. 1.
- (2) Measured on 8.3 ms single half sine-wave or equivalent square wave, duty cycle = 4 pulses per minute maximum.
- (3)  $V_F < 3.5\text{V}$  for devices of  $V_{BR} < 200\text{V}$  and  $V_F < 5.0\text{V}$  for devices of  $V_{BR} > 201\text{V}$ .

## RATING AND CHARACTERISTIC (3KP-G Series)

Fig.1 Pulse Derating Curve

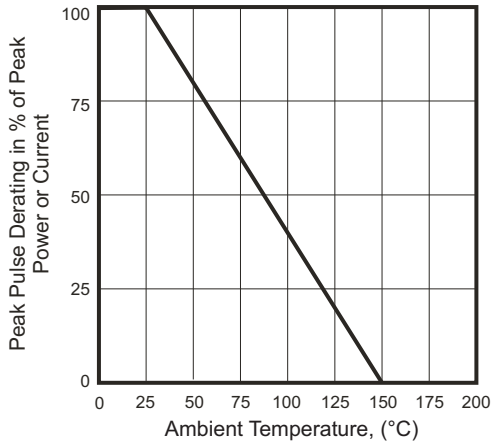

Fig.2 Max. Non-repetitive Surge Current

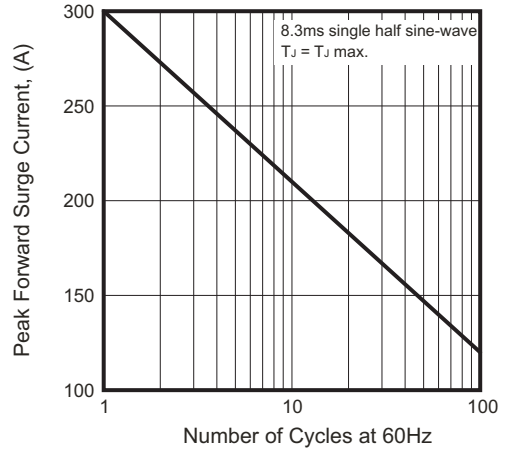

Fig.3 Peak Pulse Power Rating Curve

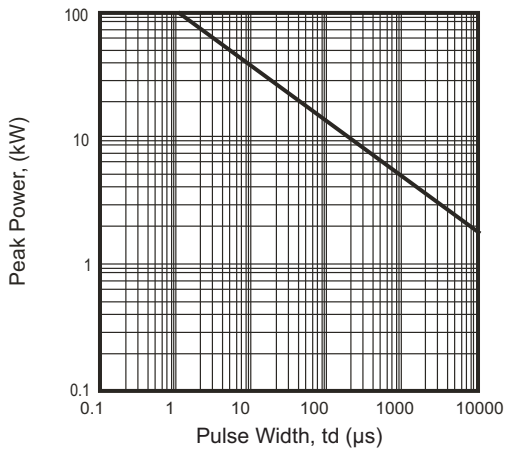

Fig.4 Steady State Power Derating Curve

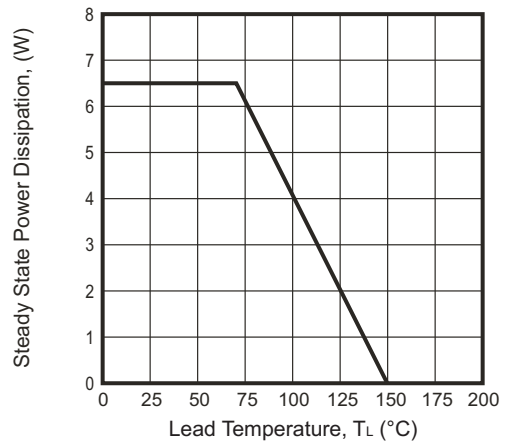
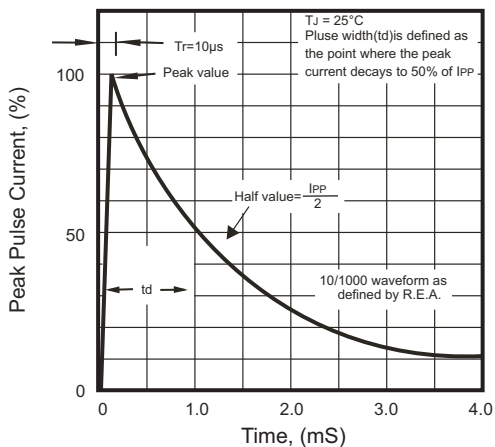

Fig.5 Pulse Waveform



# 3000W Transient Voltage Suppressor

## Electrical Characteristics (TA=25°C unless otherwise noted)

Part No.	Breakdown Voltage VBR (V) @ IT			Maximum Reverse Leakage at VRWM IR (uA)	Working Peak Reverse Voltage VRWM (V)	Maximum Reverse Surge Current I <sub>PP</sub> (A)	Maximum Clamping Voltage at IPP V <sub>c</sub> (V)	Marking Code	
	MIN.(V)	MAX.(V)	IT(mA)					UNI	BI
3KP5.0(C)A-G	6.40	7.00	50	5000	5.0	326.09	9.2	3KP5.0A	3KP5.0CA
3KP6.0(C)A-G	6.67	7.37	50	5000	6.0	291.26	10.3	3KP6.0A	3KP6.0CA
3KP6.5(C)A-G	7.22	7.98	50	2000	6.5	267.86	11.2	3KP6.5A	3KP6.5CA
3KP7.0(C)A-G	7.78	8.60	50	1000	7.0	250.00	12.0	3KP7.0A	3KP7.0CA
3KP7.5(C)A-G	8.33	9.21	5	250	7.5	232.56	12.9	3KP7.5A	3KP7.5CA
3KP8.0(C)A-G	8.89	9.83	5	150	8.0	220.59	13.6	3KP8.0A	3KP8.0CA
3KP8.5(C)A-G	9.44	10.4	5	50	8.5	208.33	14.4	3KP8.5A	3KP8.5CA
3KP9.0(C)A-G	10.0	11.1	5	20	9.0	194.81	15.4	3KP9.0A	3KP9.0CA
3KP10(C)A-G	11.1	12.3	5	15	10.0	176.47	17.0	3KP10A	3KP10CA
3KP11(C)A-G	12.2	13.5	5	2	11.0	164.84	18.2	3KP11A	3KP11CA
3KP12(C)A-G	13.3	14.7	5	2	12.0	150.75	19.9	3KP12A	3KP12CA
3KP13(C)A-G	14.4	15.9	5	2	13.0	139.53	21.5	3KP13A	3KP13CA
3KP14(C)A-G	15.6	17.2	5	2	14.0	129.31	23.2	3KP14A	3KP14CA
3KP15(C)A-G	16.7	18.5	5	2	15.0	122.95	24.4	3KP15A	3KP15CA
3KP16(C)A-G	17.8	19.7	5	2	16.0	115.38	26.0	3KP16A	3KP16CA
3KP17(C)A-G	18.9	20.9	5	2	17.0	108.70	27.6	3KP17A	3KP17CA
3KP18(C)A-G	20.0	22.1	5	2	18.0	102.74	29.2	3KP18A	3KP18CA
3KP19(C)A-G	21.1	23.3	5	2	19.0	97.47	30.8	3KP19A	3KP19CA
3KP20(C)A-G	22.2	24.5	5	2	20.0	92.59	32.4	3KP20A	3KP20CA
3KP22(C)A-G	24.4	26.9	5	2	22.0	84.51	35.5	3KP22A	3KP22CA
3KP24(C)A-G	26.7	29.5	5	2	24.0	77.12	38.9	3KP24A	3KP24CA
3KP26(C)A-G	28.9	31.9	5	2	26.0	71.26	42.1	3KP26A	3KP26CA
3KP28(C)A-G	31.1	34.4	5	2	28.0	66.08	45.4	3KP28A	3KP28CA
3KP30(C)A-G	33.3	36.8	5	2	30.0	61.98	48.4	3KP30A	3KP30CA
3KP33(C)A-G	36.7	40.6	5	2	33.0	56.29	53.3	3KP33A	3KP33CA
3KP36(C)A-G	40.0	44.2	5	2	36.0	51.64	58.1	3KP36A	3KP36CA
3KP40(C)A-G	44.4	49.1	5	2	40.0	46.51	64.5	3KP40A	3KP40CA
3KP43(C)A-G	43.0	47.8	5	2	43.0	43.23	69.4	3KP43A	3KP43CA
3KP45(C)A-G	50.0	55.3	5	2	45.0	41.27	72.7	3KP45A	3KP45CA
3KP48(C)A-G	53.3	58.9	5	2	48.0	38.76	77.4	3KP48A	3KP48CA
3KP51(C)A-G	56.7	62.7	5	2	51.0	36.41	82.4	3KP51A	3KP51CA
3KP54(C)A-G	60.0	66.3	5	2	54.0	34.44	87.1	3KP54A	3KP54CA

# 3000W Transient Voltage Suppressor

## Electrical Characteristics (TA=25°C unless otherwise noted)

Part No.	Breakdown Voltage VBR (V) @ IT			Maximum Reverse Leakage at VRWM IR (uA)	Working Peak Reverse Voltage VRWM (V)	Maximum Reverse Surge Current IPP(A)	Maximum Clamping Voltage at IPP Vc(V)	Marking Code	
	MIN.(V)	MAX.(V)	IT(mA)					UNI	BI
3KP58(C)A-G	64.4	71.2	5	2	58.0	32.05	93.6	3KP58A	3KP58CA
3KP60(C)A-G	66.7	73.7	5	2	60.0	30.99	96.8	3KP60A	3KP60CA
3KP64(C)A-G	71.1	78.6	5	2	64.0	29.13	103.0	3KP64A	3KP64CA
3KP70(C)A-G	77.8	86.0	5	2	70.0	26.55	113.0	3KP70A	3KP70CA
3KP75(C)A-G	83.3	92.1	5	2	75.0	24.79	121.0	3KP75A	3KP75CA
3KP78(C)A-G	86.7	95.8	5	2	78.0	23.81	126.0	3KP78A	3KP78CA
3KP80(C)A-G	88.8	97.6	5	2	80.0	23.15	137.0	3KP80A	3KP80CA
3KP85(C)A-G	94.4	104.0	5	2	85.0	21.9	137.0	3KP85A	3KP85CA
3KP90(C)A-G	100	111	5	2	90	20.55	146	3KP90A	3KP90CA
3KP100(C)A-G	111	123	5	2	100	18.52	162	3KP100A	3KP100CA
3KP110(C)A-G	122	135	5	2	110	16.95	177	3KP110A	3KP110CA
3KP120(C)A-G	133	147	5	2	120	15.54	193	3KP120A	3KP120CA
3KP130(C)A-G	144	159	5	2	130	14.35	209	3KP130A	3KP130CA
3KP140(C)A-G	155	171	5	2	140	13.23	227	3KP140A	3KP140CA
3KP150(C)A-G	167	185	5	2	150	12.35	243	3KP150A	3KP150CA
3KP160(C)A-G	178	197	5	2	160	11.58	259	3KP160A	3KP160CA
3KP170(C)A-G	189	209	5	2	170	10.91	275	3KP170A	3KP170CA
3KP180(C)A-G	200	220	5	2	180	10.29	292	3KP180A	3KP180CA
3KP190(C)A-G	211	232	5	2	190	9.75	308	3KP190A	3KP190CA
3KP200(C)A-G	224	247	5	2	200	9.26	324	3KP200A	3KP200CA
3KP210(C)A-G	233	258	5	2	210	8.58	350	3KP210A	3KP210CA
3KP220(C)A-G	246	272	5	2	220	8.43	356	3KP220A	3KP220CA
3KP250(C)A-G	279	309	5	2	250	7.41	405	3KP250A	3KP250CA
3KP300(C)A-G	335	371	5	2	300	6.17	486	3KP300A	3KP300CA
3KP350(C)A-G	391	432	5	2	350	5.29	567	3KP350A	3KP350CA
3KP400(C)A-G	447	494	5	2	400	4.63	648	3KP400A	3KP400CA
3KP440(C)A-G	492	543	5	2	440	4.21	713	3KP440A	3KP440CA

NOTES:

1. Suffix 'A ' denotes 5% tolerance device.
2. Add suffix 'C 'or ' CA ' after part number to specify Bi-directional devices.
3. For Bi-Directional devices having Vr of 10 volts and under, the Ir limit is double.

## Taping Specification For Axial Lead Diodes

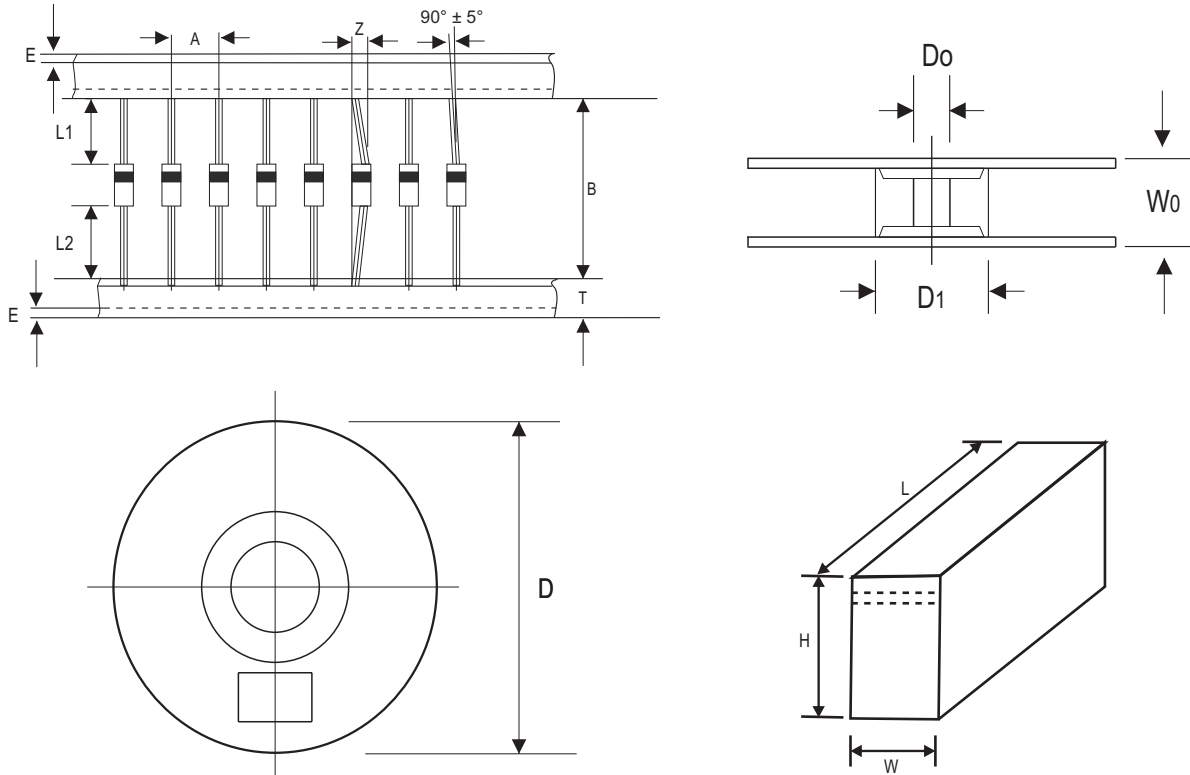

R-6	SYMBOL	A	B	Z	T	E	L1	L2
	(mm)	10.00 ± 0.50	52.00 ± 0.50	1.20 (max)	6.00 ± 0.40	1.00 (max)	1.00 (max)	1.00 (max)
	(inch)	0.394 ± 0.020	2.047 ± 0.020	0.047 (max)	0.236 ± 0.016	0.039 (max)	0.039 (max)	0.039 (max)

R-6	SYMBOL	D1	D0	D	W0	L	W	H
	(mm)	85.70 ± 0.30	16.60 ± 0.40	330.00	72.00 ± 3.00	260.00	75.00	145.00
	(inch)	3.374 ± 0.012	0.654 ± 0.016	13.000	2.835 ± 0.118	10.236	2.953	5.709

## Standard Packaging

Case Type	AMMO PACK	
	BOX ( pcs )	CARTON ( pcs )
R-6	250	3,750

Компания «Океан Электроники» предлагает заключение долгосрочных отношений при поставках импортных электронных компонентов на взаимовыгодных условиях!

Наши преимущества:

- Поставка оригинальных импортных электронных компонентов напрямую с производств Америки, Европы и Азии, а так же с крупнейших складов мира;
- Широкая линейка поставок активных и пассивных импортных электронных компонентов (более 30 млн. наименований);
- Поставка сложных, дефицитных, либо снятых с производства позиций;
- Оперативные сроки поставки под заказ (от 5 рабочих дней);
- Экспресс доставка в любую точку России;
- Помощь Конструкторского Отдела и консультации квалифицированных инженеров;
- Техническая поддержка проекта, помощь в подборе аналогов, поставка прототипов;
- Поставка электронных компонентов под контролем ВП;
- Система менеджмента качества сертифицирована по Международному стандарту ISO 9001;
- При необходимости вся продукция военного и аэрокосмического назначения проходит испытания и сертификацию в лаборатории (по согласованию с заказчиком);
- Поставка специализированных компонентов военного и аэрокосмического уровня качества (Xilinx, Altera, Analog Devices, Intersil, Interpoint, Microsemi, Actel, Aeroflex, Peregrine, VPT, Syfer, Eurofarad, Texas Instruments, MS Kennedy, Miteq, Cobham, E2V, MA-COM, Hittite, Mini-Circuits, General Dynamics и др.);

Компания «Океан Электроники» является официальным дистрибьютором и эксклюзивным представителем в России одного из крупнейших производителей разъемов военного и аэрокосмического назначения «JONHON», а так же официальным дистрибьютором и эксклюзивным представителем в России производителя высокотехнологичных и надежных решений для передачи СВЧ сигналов «FORSTAR».



## JONHON

«JONHON» (основан в 1970 г.)

Разъемы специального, военного и аэрокосмического назначения:

(Применяются в военной, авиационной, аэрокосмической, морской, железнодорожной, горно- и нефтедобывающей отраслях промышленности)

«FORSTAR» (основан в 1998 г.)

ВЧ соединители, коаксиальные кабели, кабельные сборки и микроволновые компоненты:

(Применяются в телекоммуникациях гражданского и специального назначения, в средствах связи, РЛС, а так же военной, авиационной и аэрокосмической отраслях промышленности).



Телефон: 8 (812) 309-75-97 (многоканальный)

Факс: 8 (812) 320-03-32

Электронная почта: [ocean@oceanchips.ru](mailto:ocean@oceanchips.ru)

Web: <http://oceanchips.ru/>

Адрес: 198099, г. Санкт-Петербург, ул. Калинина, д. 2, корп. 4, лит. А