



**MICROCHIP**

# TC4467/TC4468/TC4469

## Logic-Input CMOS Quad Drivers

### Features

- High Peak Output Current: 1.2 A
- Wide Operating Range:
  - 4.5 V to 18 V
- Symmetrical Rise/Fall Times: 25 nsec
- Short, Equal Delay Times: 75 nsec
- Latch-proof. Will Withstand 500 mA Inductive Kickback
- 3 Input Logic Choices:
  - AND / NAND / AND + Inv
- ESD Protection on All Pins: 2 kV

### Applications

- General Purpose CMOS Logic Buffer
- Driving All Four MOSFETs in an H-Bridge
- Direct Small Motor Driver
- Relay or Peripheral Drivers
- CCD Driver
- Pin-Switching Network Driver

### General Description

The TC4467/TC4468/TC4469 devices are a family of four-output CMOS buffers/MOSFET drivers with 1.2 A peak drive capability. Unlike other MOSFET drivers, these devices have two inputs for each output. The inputs are configured as logic gates: NAND (TC4467), AND (TC4468) and AND/INV (TC4469).

The TC4467/TC4468/TC4469 drivers can continuously source up to 250 mA into ground referenced loads. These devices are ideal for direct driving low current motors or driving MOSFETs in a H-bridge configuration for higher current motor drive (see Section 5.0 for details). Having the logic gates onboard the driver can help to reduce component count in many designs.

The TC4467/TC4468/TC4469 devices are very robust and highly latch-up resistant. They can tolerate up to 5 V of noise spiking on the ground line and can handle up to 0.5 A of reverse current on the driver outputs.

The TC4467/4468/4469 devices are available in commercial, industrial and military temperature ranges.

### Package Types



# TC4467/TC4468/TC4469

## Logic Diagrams



# TC4467/TC4468/TC4469

## 1.0 ELECTRICAL CHARACTERISTICS

### Absolute Maximum Ratings†

Supply Voltage .....	+20 V
Input Voltage .....	(GND – 5 V) to ( $V_{DD} + 0.3$ V)
Package Power Dissipation: ( $T_A \leq 70^\circ\text{C}$ )	
PDIP .....	800 mW
CERDIP .....	840 mW
SOIC .....	760 mW
Package Thermal Resistance:	
CERDIP $R_{\theta J-A}$ .....	100°C/W
CERDIP $R_{\theta J-C}$ .....	23°C/W
PDIP $R_{\theta J-A}$ .....	80°C/W
PDIP $R_{\theta J-C}$ .....	35°C/W
SOIC $R_{\theta J-A}$ .....	95°C/W
SOIC $R_{\theta J-C}$ .....	28°C/W
Operating Temperature Range:	
C Version .....	0°C to +70°C
E Version .....	-40°C to +85°C
M Version .....	-55°C to +125°C
Maximum Chip Temperature .....	+150°C
Storage Temperature Range .....	-65°C to +150°C

†**Notice:** Stresses above those listed under "Maximum Ratings" may cause permanent damage to the device. This is a stress rating only and functional operation of the device at those or any other conditions above those indicated in the operation listings of this specification is not implied. Exposure to maximum rating conditions for extended periods may affect device reliability.

## ELECTRICAL SPECIFICATIONS

Electrical Characteristics: Unless otherwise noted, $T_A = +25^\circ\text{C}$ , with $4.5\text{ V} \leq V_{DD} \leq 18\text{ V}$ .						
Parameters	Sym	Min	Typ	Max	Units	Conditions
<b>Input</b>						
Logic 1, High Input Voltage	$V_{IH}$	2.4	—	$V_{DD}$	V	<b>Note 3</b>
Logic 0, Low Input Voltage	$V_{IL}$	—	—	0.8	V	<b>Note 3</b>
Input Current	$I_{IN}$	-1.0	—	+1.0	$\mu\text{A}$	$0\text{ V} \leq V_{IN} \leq V_{DD}$
<b>Output</b>						
High Output Voltage	$V_{OH}$	$V_{DD} - 0.025$	—	—	V	$I_{LOAD} = 100\ \mu\text{A}$ ( <b>Note 1</b> )
Low Output Voltage	$V_{OL}$	—	—	0.15	V	$I_{LOAD} = 10\ \text{mA}$ ( <b>Note 1</b> )
Output Resistance	$R_O$	—	10	15	$\Omega$	$I_{OUT} = 10\ \text{mA}$ , $V_{DD} = 18\text{ V}$
Peak Output Current	$I_{PK}$	—	1.2	—	A	
Continuous Output Current	$I_{DC}$	—	—	300	mA	Single Output
		—	—	500		Total Package
Latch-Up Protection Withstand Reverse Current	I	—	500	—	mA	$4.5\text{ V} \leq V_{DD} \leq 16\text{ V}$
<b>Switching Time (Note 1)</b>						
Rise Time	$t_R$	—	15	25	nsec	Figure 4-1
Fall Time	$t_F$	—	15	25	nsec	Figure 4-1
Delay Time	$t_{D1}$	—	40	75	nsec	Figure 4-1
Delay Time	$t_{D2}$	—	40	75	nsec	Figure 4-1
<b>Power Supply</b>						
Power Supply Current	$I_S$	—	1.5	4	mA	<b>Note 2</b>
Power Supply Voltage	$V_{DD}$	4.5	—	18	V	

- Note 1:** Totem pole outputs should not be paralleled because the propagation delay differences from one to the other could cause one driver to drive high a few nanoseconds before another. The resulting current spike, although short, may decrease the life of the device. Switching times are ensured by design.
- Note 2:** When driving all four outputs simultaneously in the same direction,  $V_{DD}$  will be limited to 16 V. This reduces the chance that internal  $dV/dt$  will cause high-power dissipation in the device.
- Note 3:** The input threshold has approximately 50 mV of hysteresis centered at approximately 1.5 V. Input rise times should be kept below 5  $\mu\text{sec}$  to avoid high internal peak currents during input transitions. Static input levels should also be maintained above the maximum, or below the minimum, input levels specified in the "Electrical Characteristics" to avoid increased power dissipation in the device.

# TC4467/TC4468/TC4469

## ELECTRICAL SPECIFICATIONS (OPERATING TEMPERATURES)

Electrical Characteristics: Unless otherwise noted, over operating temperature range with $4.5\text{ V} \leq V_{DD} \leq 18\text{ V}$ .						
Parameters	Sym	Min	Typ	Max	Units	Conditions
<b>Input</b>						
Logic 1, High Input Voltage	$V_{IH}$	2.4	—	—	V	<b>Note 3</b>
Logic 0, Low Input Voltage	$V_{IL}$	—	—	0.8	V	<b>Note 3</b>
Input Current	$I_{IN}$	-10	—	10	$\mu\text{A}$	$0\text{ V} \leq V_{IN} \leq V_{DD}$
<b>Output</b>						
High Output Voltage	$V_{OH}$	$V_{DD} - 0.025$	—	—	V	$I_{LOAD} = 100\ \mu\text{A}$ ( <b>Note 1</b> )
Low Output Voltage	$V_{OL}$	—	—	0.30	V	$I_{LOAD} = 10\ \text{mA}$ ( <b>Note 1</b> )
Output Resistance	$R_O$	—	20	30	$\Omega$	$I_{OUT} = 10\ \text{mA}$ , $V_{DD} = 18\ \text{V}$
Peak Output Current	$I_{PK}$	—	1.2	—	A	
Continuous Output Current	$I_{DC}$	—	—	300	mA	Single Output
		—	—	500		Total Package
Latch-Up Protection Withstand Reverse Current	I	—	500	—	mA	$4.5\text{ V} \leq V_{DD} \leq 16\ \text{V}$
<b>Switching Time (Note 1)</b>						
Rise Time	$t_R$	—	15	50	nsec	Figure 4-1
Fall Time	$t_F$	—	15	50	nsec	Figure 4-1
Delay Time	$t_{D1}$	—	40	100	nsec	Figure 4-1
Delay Time	$t_{D2}$	—	40	100	nsec	Figure 4-1
<b>Power Supply</b>						
Power Supply Current	$I_S$	—	—	8	mA	<b>Note 2</b>
Power Supply Voltage	$V_{DD}$	4.5	—	18	V	

- Note 1:** Totem pole outputs should not be paralleled because the propagation delay differences from one to the other could cause one driver to drive high a few nanoseconds before another. The resulting current spike, although short, may decrease the life of the device. Switching times are ensured by design.
- Note 2:** When driving all four outputs simultaneously in the same direction,  $V_{DD}$  will be limited to 16 V. This reduces the chance that internal  $dv/dt$  will cause high-power dissipation in the device.
- Note 3:** The input threshold has approximately 50 mV of hysteresis centered at approximately 1.5 V. Input rise times should be kept below 5  $\mu\text{sec}$  to avoid high internal peak currents during input transitions. Static input levels should also be maintained above the maximum, or below the minimum, input levels specified in the "Electrical Characteristics" to avoid increased power dissipation in the device.

## TRUTH TABLE

Part No.	TC4467 NAND				TC4468 AND				TC4469 AND/INV			
Inputs A	H	H	L	L	H	H	L	L	H	H	L	L
Inputs B	H	L	H	L	H	L	H	L	H	L	H	L
Outputs TC446X	L	H	H	H	H	L	L	L	L	H	L	L

Legend: H = High L = Low

## 2.0 TYPICAL PERFORMANCE CURVES

**Note:** The graphs and tables provided following this note are a statistical summary based on a limited number of samples and are provided for informational purposes only. The performance characteristics listed herein are not tested or guaranteed. In some graphs or tables, the data presented may be outside the specified operating range (e.g., outside specified power supply range) and therefore outside the warranted range.

**Note:**  $T_A = +25^\circ\text{C}$ , with  $4.5\text{ V} \leq V_{DD} \leq 18\text{ V}$ .



**FIGURE 2-1:** Rise Time vs. Supply Voltage.



**FIGURE 2-4:** Fall Time vs. Supply Voltage.



**FIGURE 2-2:** Rise Time vs. Capacitive Load.



**FIGURE 2-5:** Fall Time vs. Capacitive Load.



**FIGURE 2-3:** Rise/Fall Times vs. Temperature.

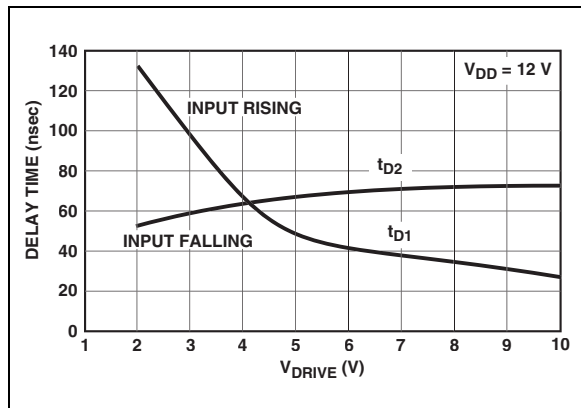

**FIGURE 2-6:** Propagation Delay Time vs. Supply Voltage.

# TC4467/TC4468/TC4469

## 2.0 TYPICAL PERFORMANCE CURVES (CONTINUED)

Note:  $T_A = +25^\circ\text{C}$ , with  $4.5\text{ V} \leq V_{DD} \leq 18\text{ V}$ .



**FIGURE 2-7:** Input Amplitude vs. Delay Times.



**FIGURE 2-10:** Propagation Delay Times vs. Temperatures.

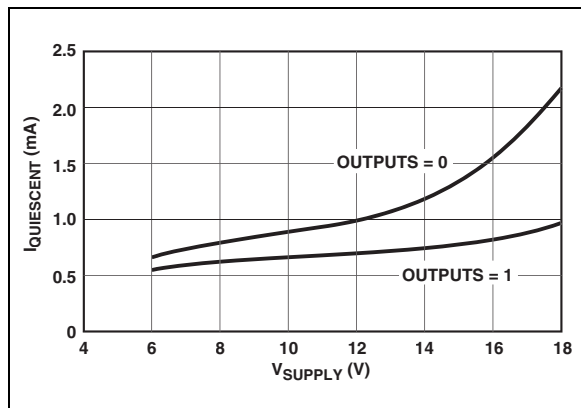

**FIGURE 2-8:** Quiescent Supply Current vs. Supply Voltage.



**FIGURE 2-11:** Quiescent Supply Current vs. Temperature.

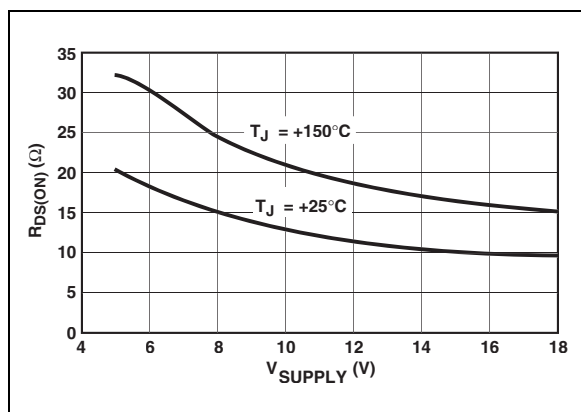

**FIGURE 2-9:** High-State Output Resistance.



**FIGURE 2-12:** Low-State Output Resistance.

## 2.0 TYPICAL PERFORMANCE CURVES (CONTINUED)

**Note:** (Load on single output only).



**FIGURE 2-13:** Supply Current vs. Capacitive Load.



**FIGURE 2-16:** Supply Current vs. Frequency.

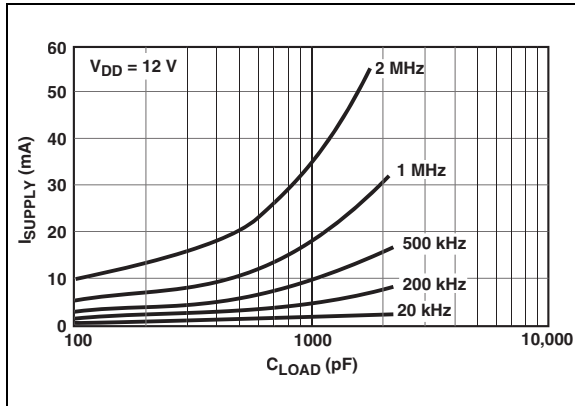

**FIGURE 2-14:** Supply Current vs. Capacitive Load.

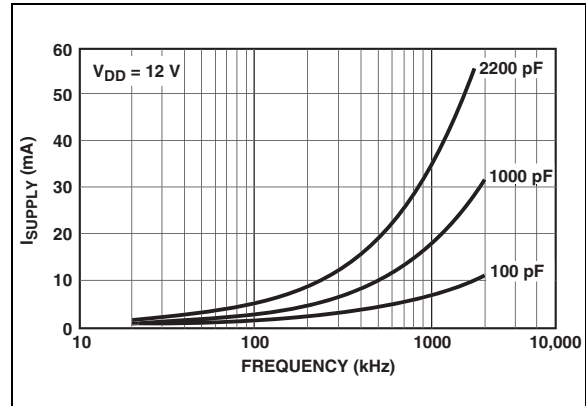

**FIGURE 2-17:** Supply Current vs. Frequency.



**FIGURE 2-15:** Supply Current vs. Capacitive Load.



**FIGURE 2-18:** Supply Current vs. Frequency.

# TC4467/TC4468/TC4469

## 3.0 PIN DESCRIPTIONS

The descriptions of the pins are listed in Table 3-1.

**TABLE 3-1: PIN FUNCTION TABLE**

14-Pin PDIP, CERDIP	16-Pin SOIC (Wide)	Description
Symbol	Symbol	
1A	1A	Input A for Driver 1, TTL/CMOS Compatible Input
1B	1B	Input B for Driver 1, TTL/CMOS Compatible Input
2A	2A	Input A for Driver 2, TTL/CMOS Compatible Input
2B	2B	Input B for Driver 2, TTL/CMOS Compatible Input
3A	3A	Input A for Driver 3, TTL/CMOS Compatible Input
3B	3B	Input B for Driver 3, TTL/CMOS Compatible Input
GND	GND	Ground
—	GND	Ground
4A	4A	Input A for Driver 4, TTL/CMOS Compatible Input
4B	4B	Input B for Driver 4, TTL/CMOS Compatible Input
4Y	4Y	Output for Driver 4, CMOS Push-Pull Output
3Y	3Y	Output for Driver 3, CMOS Push-Pull Output
2Y	2Y	Output for Driver 2, CMOS Push-Pull Output
1Y	1Y	Output for Driver 1, CMOS Push-Pull Output
V <sub>DD</sub>	V <sub>DD</sub>	Supply Input, 4.5 V to 18 V
—	V <sub>DD</sub>	Supply Input, 4.5 V to 18 V



## 4.0 DETAILED DESCRIPTION

### 4.1 Supply Bypassing

Large currents are required to charge and discharge large capacitive loads quickly. For example, charging a 1000 pF load to 18 V in 25 nsec requires 0.72 A from the device's power supply.

To ensure low supply impedance over a wide frequency range, a 1  $\mu$ F film capacitor in parallel with one or two low-inductance, 0.1  $\mu$ F ceramic disk capacitors with short lead lengths (<0.5 in.) normally provide adequate bypassing.

### 4.2 Grounding

The TC4467 and TC4469 contain inverting drivers. Potential drops developed in common ground impedances from input to output will appear as negative feedback and degrade switching speed characteristics. Instead, individual ground returns for input and output circuits, or a ground plane, should be used.

### 4.3 Input Stage

The input voltage level changes the no-load or quiescent supply current. The N-channel MOSFET input stage transistor drives a 2.5 mA current source load. With logic "0" outputs, maximum quiescent supply current is 4 mA. Logic "1" output level signals reduce quiescent current to 1.4 mA, maximum. Unused driver inputs must be connected to  $V_{DD}$  or  $V_{SS}$ . Minimum power dissipation occurs for logic "1" outputs.

The drivers are designed with 50 mV of hysteresis, which provides clean transitions and minimizes output stage current spiking when changing states. Input voltage thresholds are approximately 1.5 V, making any voltage greater than 1.5 V, up to  $V_{DD}$ , a logic "1" input. Input current is less than 1  $\mu$ A over this range.

### 4.4 Power Dissipation

The supply current versus frequency and supply current versus capacitive load characteristic curves will aid in determining power dissipation calculations. Microchip Technology's CMOS drivers have greatly reduced quiescent DC power consumption.

Input signal duty cycle, power supply voltage and load type influence package power dissipation. Given power dissipation and package thermal resistance, the maximum ambient operating temperature is easily calculated. The 14-pin plastic package junction-to-ambient thermal resistance is 83.3°C/W. At +70°C, the package is rated at 800 mW maximum dissipation. Maximum allowable chip temperature is +150°C.

Three components make up total package power dissipation:

1. Load-caused dissipation ( $P_L$ ).
2. Quiescent power ( $P_Q$ ).
3. Transition power ( $P_T$ ).

A capacitive-load-caused dissipation (driving MOSFET gates), is a direct function of frequency, capacitive load and supply voltage. The power dissipation is:

#### EQUATION

$$P_L = fCV_S^2$$

$f$  = Switching Frequency  
 $C$  = Capacitive Load  
 $V_S$  = Supply Voltage

A resistive-load-caused dissipation for ground-referenced loads is a function of duty cycle, load current and load voltage. The power dissipation is:

#### EQUATION

$$P_L = D(V_S - V_L)I_L$$

$D$  = Duty Cycle  
 $V_S$  = Supply Voltage  
 $V_L$  = Load Voltage  
 $I_L$  = Load Current

# TC4467/TC4468/TC4469

A resistive-load-caused dissipation for supply-referenced loads is a function of duty cycle, load current and output voltage. The power dissipation is

## EQUATION

$$P_L = DV_O I_L$$

$D$  = Duty Cycle

$V_O$  = Device Output Voltage

$I_L$  = Load Current

Quiescent power dissipation depends on input signal duty cycle. Logic HIGH outputs result in a lower power dissipation mode, with only 0.6 mA total current drain (all devices driven). Logic LOW outputs raise the current to 4 mA maximum. The quiescent power dissipation is:

## EQUATION

$$P_Q = V_S(D(I_H) + (1 - D)I_L)$$

$I_H$  = Quiescent Current with all outputs LOW  
(4 mA max.)

$I_L$  = Quiescent Current with all outputs HIGH  
(0.6 mA max.)

$D$  = Duty Cycle

$V_S$  = Supply Voltage

Transition power dissipation arises in the complimentary configuration (TC446X) because the output stage N-channel and P-channel MOS transistors are ON simultaneously for a very short period when the output changes. The transition power dissipation is approximately:

## EQUATION

$$P_T = fV_S(10 \times 10^{-9})$$

$C = 1000$  pF Capacitive Load

$V_S = 15$  V

$D = 50\%$

$f = 200$  kHz

$P_D$  = Package Power Dissipation

=  $P_L + P_Q + P_T$

=  $45mW + 35mW + 30mW$

=  $110mW$

Package power dissipation is the sum of load, quiescent and transition power dissipations. An example shows the relative magnitude for each term:

Maximum operating temperature is:

## EQUATION

$$T_J - \theta_{JA}(P_D) = 141^\circ\text{C}$$

$T_J$  = Maximum allowable junction temperature  
(+150°C)

$\theta_{JA}$  = Junction-to-ambient thermal resistance  
(83.3°C/W) 14-pin plastic package

**Note:** Ambient operating temperature should not exceed +85°C for "EJD" device or +125°C for "MJD" device.

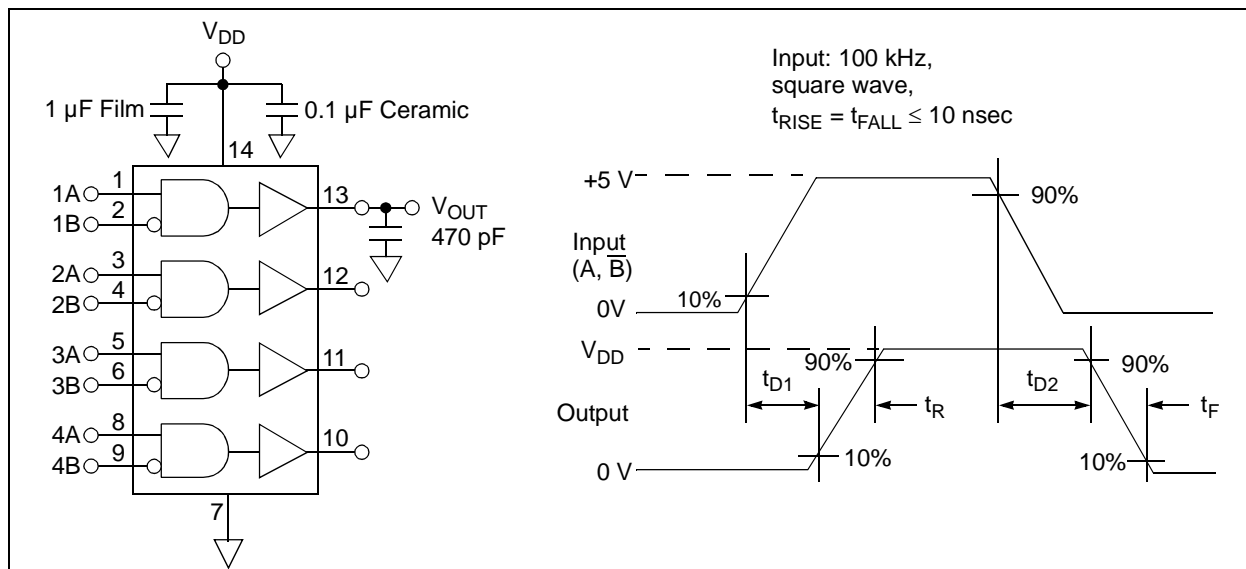

**FIGURE 4-1:** Switching Time Test Circuit.

## 5.0 APPLICATIONS INFORMATION



**FIGURE 5-1:** Stepper Motor Drive.



**FIGURE 5-2:** Quad Driver For H-bridge Motor Control.

# TC4467/TC4468/TC4469

## 6.0 PACKAGING INFORMATION

### 6.1 Package Marking Information

14-Lead PDIP (300 mil)

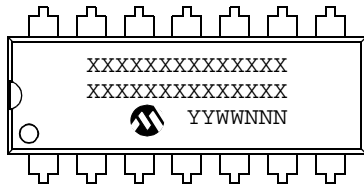

Example:

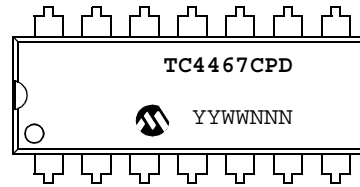

14-Lead CERDIP (300 mil)

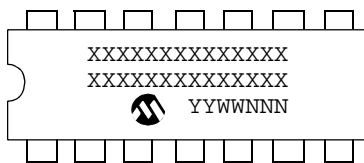

Example:

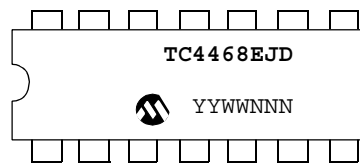

16-Lead SOIC (300 mil)



Example:

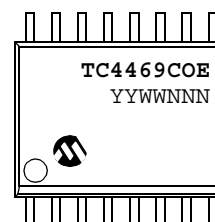

<b>Legend:</b>	XX...X	Customer-specific information
	Y	Year code (last digit of calendar year)
	YY	Year code (last 2 digits of calendar year)
	WW	Week code (week of January 1 is week '01')
	NNN	Alphanumeric traceability code
	(e3)	Pb-free JEDEC designator for Matte Tin (Sn)
	*	This package is Pb-free. The Pb-free JEDEC designator (e3) can be found on the outer packaging for this package.

**Note:** In the event the full Microchip part number cannot be marked on one line, it will be carried over to the next line, thus limiting the number of available characters for customer-specific information.

# TC4467/TC4468/TC4469

## 14-Lead Plastic Dual In-line (P) – 300 mil (PDIP)

**Note:** For the most current package drawings, please see the Microchip Packaging Specification located at <http://www.microchip.com/packaging>

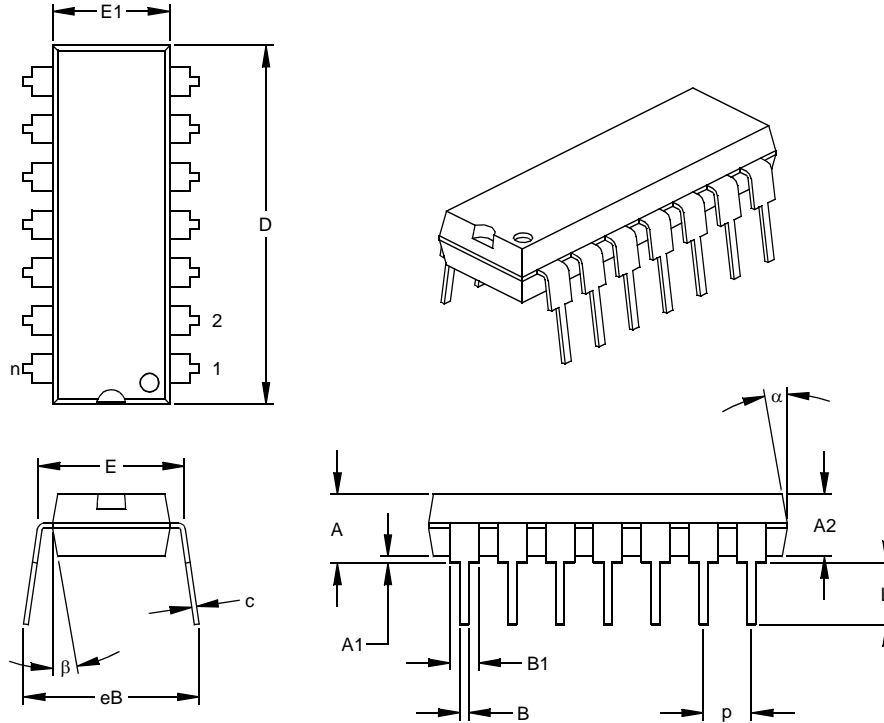

Units		INCHES*			MILLIMETERS		
Dimension Limits		MIN	NOM	MAX	MIN	NOM	MAX
Number of Pins	n		14			14	
Pitch	p		.100			2.54	
Top to Seating Plane	A	.140	.155	.170	3.56	3.94	4.32
Molded Package Thickness	A2	.115	.130	.145	2.92	3.30	3.68
Base to Seating Plane	A1	.015			0.38		
Shoulder to Shoulder Width	E	.300	.313	.325	7.62	7.94	8.26
Molded Package Width	E1	.240	.250	.260	6.10	6.35	6.60
Overall Length	D	.740	.750	.760	18.80	19.05	19.30
Tip to Seating Plane	L	.125	.130	.135	3.18	3.30	3.43
Lead Thickness	c	.008	.012	.015	0.20	0.29	0.38
Upper Lead Width	B1	.045	.058	.070	1.14	1.46	1.78
Lower Lead Width	B	.014	.018	.022	0.36	0.46	0.56
Overall Row Spacing	§ eB	.310	.370	.430	7.87	9.40	10.92
Mold Draft Angle Top	α	5	10	15	5	10	15
Mold Draft Angle Bottom	β	5	10	15	5	10	15

\* Controlling Parameter

§ Significant Characteristic

Notes:

Dimensions D and E1 do not include mold flash or protrusions. Mold flash or protrusions shall not exceed

.010" (0.254mm) per side.

JEDEC Equivalent: MS-001

Drawing No. C04-005

# TC4467/TC4468/TC4469

## 14-Lead Ceramic Dual In-line – 300 mil (CERDIP)

**Note:** For the most current package drawings, please see the Microchip Packaging Specification located at <http://www.microchip.com/packaging>

### 14-Pin CERDIP (Narrow)

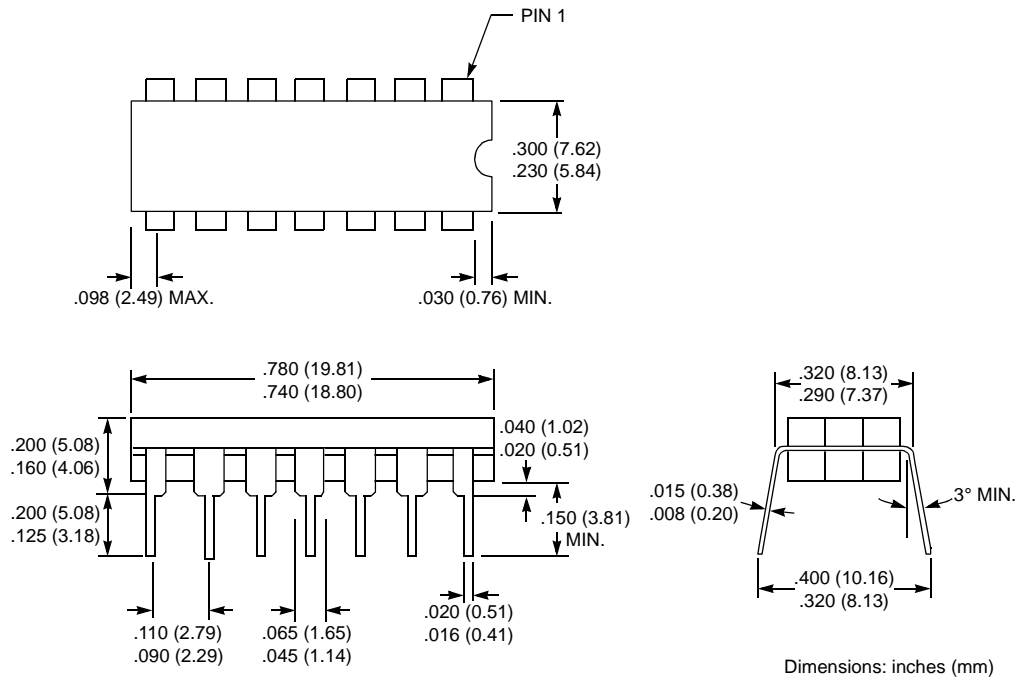

# TC4467/TC4468/TC4469

## 16-Lead Plastic Small Outline (SO) – Wide, 300 mil (SOIC)

**Note:** For the most current package drawings, please see the Microchip Packaging Specification located at <http://www.microchip.com/packaging>



Dimension Limits	Units	INCHES*			MILLIMETERS		
		MIN	NOM	MAX	MIN	NOM	MAX
Number of Pins	n		16			16	
Pitch	p		.050			1.27	
Overall Height	A	.093	.099	.104	2.36	2.50	2.64
Molded Package Thickness	A2	.088	.091	.094	2.24	2.31	2.39
Standoff §	A1	.004	.008	.012	0.10	0.20	0.30
Overall Width	E	.394	.407	.420	10.01	10.34	10.67
Molded Package Width	E1	.291	.295	.299	7.39	7.49	7.59
Overall Length	D	.398	.406	.413	10.10	10.30	10.49
Chamfer Distance	h	.010	.020	.029	0.25	0.50	0.74
Foot Length	L	.016	.033	.050	0.41	0.84	1.27
Foot Angle	φ	0	4	8	0	4	8
Lead Thickness	c	.009	.011	.013	0.23	0.28	0.33
Lead Width	B	.014	.017	.020	0.36	0.42	0.51
Mold Draft Angle Top	α	0	12	15	0	12	15
Mold Draft Angle Bottom	β	0	12	15	0	12	15

\* Controlling Parameter  
§ Significant Characteristic

**Notes:**

Dimensions D and E1 do not include mold flash or protrusions. Mold flash or protrusions shall not exceed .010" (0.254mm) per side.

JEDEC Equivalent: MS-013

Drawing No. C04-102

# TC4467/TC4468/TC4469

---

---

## 7.0 REVISION HISTORY

### Revision C (December 2012)

Added a note to each package outline drawing.



## THE MICROCHIP WEB SITE

Microchip provides online support via our WWW site at [www.microchip.com](http://www.microchip.com). This web site is used as a means to make files and information easily available to customers. Accessible by using your favorite Internet browser, the web site contains the following information:

- **Product Support** – Data sheets and errata, application notes and sample programs, design resources, user's guides and hardware support documents, latest software releases and archived software
- **General Technical Support** – Frequently Asked Questions (FAQ), technical support requests, online discussion groups, Microchip consultant program member listing
- **Business of Microchip** – Product selector and ordering guides, latest Microchip press releases, listing of seminars and events, listings of Microchip sales offices, distributors and factory representatives

## CUSTOMER CHANGE NOTIFICATION SERVICE

Microchip's customer notification service helps keep customers current on Microchip products. Subscribers will receive e-mail notification whenever there are changes, updates, revisions or errata related to a specified product family or development tool of interest.

To register, access the Microchip web site at [www.microchip.com](http://www.microchip.com). Under "Support", click on "Customer Change Notification" and follow the registration instructions.

## CUSTOMER SUPPORT

Users of Microchip products can receive assistance through several channels:

- Distributor or Representative
- Local Sales Office
- Field Application Engineer (FAE)
- Technical Support

Customers should contact their distributor, representative or field application engineer (FAE) for support. Local sales offices are also available to help customers. A listing of sales offices and locations is included in the back of this document.

**Technical support is available through the web site at: <http://microchip.com/support>**

# TC4467/4468/4469

---

---

## READER RESPONSE

It is our intention to provide you with the best documentation possible to ensure successful use of your Microchip product. If you wish to provide your comments on organization, clarity, subject matter, and ways in which our documentation can better serve you, please FAX your comments to the Technical Publications Manager at (480) 792-4150.

Please list the following information, and use this outline to provide us with your comments about this document.

TO: Technical Publications Manager Total Pages Sent \_\_\_\_\_

RE: Reader Response

From: Name \_\_\_\_\_

Company \_\_\_\_\_

Address \_\_\_\_\_

City / State / ZIP / Country \_\_\_\_\_

Telephone: (\_\_\_\_\_) \_\_\_\_\_ - \_\_\_\_\_ FAX: (\_\_\_\_\_) \_\_\_\_\_ - \_\_\_\_\_

Application (optional):

Would you like a reply?  Y  N

Device: TC4467/4468/4469

Literature Number: DS21425C

Questions:

1. What are the best features of this document?

\_\_\_\_\_  
\_\_\_\_\_

2. How does this document meet your hardware and software development needs?

\_\_\_\_\_  
\_\_\_\_\_

3. Do you find the organization of this document easy to follow? If not, why?

\_\_\_\_\_  
\_\_\_\_\_

4. What additions to the document do you think would enhance the structure and subject?

\_\_\_\_\_  
\_\_\_\_\_

5. What deletions from the document could be made without affecting the overall usefulness?

\_\_\_\_\_  
\_\_\_\_\_

6. Is there any incorrect or misleading information (what and where)?

\_\_\_\_\_  
\_\_\_\_\_

7. How would you improve this document?

\_\_\_\_\_  
\_\_\_\_\_

## PRODUCT IDENTIFICATION SYSTEM

To order or obtain information, e.g., on pricing or delivery, refer to the factory or the listed sales office.

<u>PART NO.</u>	<u>X</u>	<u>XX</u>
Device	Temperature Range	Package
Device:	TC4467: 1.2A Quad MOSFET Driver, NAND TC4468: 1.2A Quad MOSFET Driver, AND TC4469: 1.2A Quad MOSFET Driver, AND/INV	
Temperature Range:	C = 0°C to +70°C E = -40°C to +85°C (CERDIP only) M = -55°C to +125°C (CERDIP only)	
Package:	PD = Plastic DIP, (300 mil body), 14-lead JD = Ceramic DIP, (300 mil body), 14-lead OE = SOIC (Wide), 16-lead OE713 = SOIC (Wide), 16-lead (Tape and Reel)	

**Examples:**

- a) TC4467COE: Commercial Temperature, SOIC package.
- b) TC4467CPD: Commercial Temperature, PDIP package.
- c) TC4467MJD: Military Temperature, Ceramic DIP package.
  
- a) TC4468COE713: Tape and Reel, Commercial Temp., SOIC package.
- b) TC4468CPD: Commercial Temperature, PDIP package.
  
- a) TC4469COE: Commercial Temperature, SOIC package.
- b) TC4469CPD: Commercial Temperature, PDIP package.

## Sales and Support

### Data Sheets

Products supported by a preliminary Data Sheet may have an errata sheet describing minor operational differences and recommended workarounds. To determine if an errata sheet exists for a particular device, please contact one of the following:

1. Your local Microchip sales office
2. The Microchip Worldwide Site ([www.microchip.com](http://www.microchip.com))

Please specify which device, revision of silicon and Data Sheet (include Literature #) you are using.

### New Customer Notification System

Register on our web site ([www.microchip.com/cn](http://www.microchip.com/cn)) to receive the most current information on our products.

# TC4467/TC4468/TC4469

---

NOTES:

---

**Note the following details of the code protection feature on Microchip devices:**

- Microchip products meet the specification contained in their particular Microchip Data Sheet.
- Microchip believes that its family of products is one of the most secure families of its kind on the market today, when used in the intended manner and under normal conditions.
- There are dishonest and possibly illegal methods used to breach the code protection feature. All of these methods, to our knowledge, require using the Microchip products in a manner outside the operating specifications contained in Microchip's Data Sheets. Most likely, the person doing so is engaged in theft of intellectual property.
- Microchip is willing to work with the customer who is concerned about the integrity of their code.
- Neither Microchip nor any other semiconductor manufacturer can guarantee the security of their code. Code protection does not mean that we are guaranteeing the product as “unbreakable.”

Code protection is constantly evolving. We at Microchip are committed to continuously improving the code protection features of our products. Attempts to break Microchip's code protection feature may be a violation of the Digital Millennium Copyright Act. If such acts allow unauthorized access to your software or other copyrighted work, you may have a right to sue for relief under that Act.

---

Information contained in this publication regarding device applications and the like is provided only for your convenience and may be superseded by updates. It is your responsibility to ensure that your application meets with your specifications. MICROCHIP MAKES NO REPRESENTATIONS OR WARRANTIES OF ANY KIND WHETHER EXPRESS OR IMPLIED, WRITTEN OR ORAL, STATUTORY OR OTHERWISE, RELATED TO THE INFORMATION, INCLUDING BUT NOT LIMITED TO ITS CONDITION, QUALITY, PERFORMANCE, MERCHANTABILITY OR FITNESS FOR PURPOSE. Microchip disclaims all liability arising from this information and its use. Use of Microchip devices in life support and/or safety applications is entirely at the buyer's risk, and the buyer agrees to defend, indemnify and hold harmless Microchip from any and all damages, claims, suits, or expenses resulting from such use. No licenses are conveyed, implicitly or otherwise, under any Microchip intellectual property rights.

#### **Trademarks**

The Microchip name and logo, the Microchip logo, dsPIC, FlashFlex, KEELOQ, KEELOQ logo, MPLAB, PIC, PICmicro, PICSTART, PIC<sup>32</sup> logo, rPIC, SST, SST Logo, SuperFlash and UNI/O are registered trademarks of Microchip Technology Incorporated in the U.S.A. and other countries.

FilterLab, Hampshire, HI-TECH C, Linear Active Thermistor, MTP, SEEVAL and The Embedded Control Solutions Company are registered trademarks of Microchip Technology Incorporated in the U.S.A.

Silicon Storage Technology is a registered trademark of Microchip Technology Inc. in other countries.

Analog-for-the-Digital Age, Application Maestro, BodyCom, chipKIT, chipKIT logo, CodeGuard, dsPICDEM, dsPICDEM.net, dsPICworks, dsSPEAK, ECAN, ECONOMONITOR, FanSense, HI-TIDE, In-Circuit Serial Programming, ICSP, Mindi, MiWi, MPASM, MPF, MPLAB Certified logo, MPLIB, MPLINK, mTouch, Omniclient Code Generation, PICC, PICC-18, PICDEM, PICDEM.net, PICkit, PICtail, REAL ICE, rLAB, Select Mode, SQI, Serial Quad I/O, Total Endurance, TSHARC, UniWinDriver, WiperLock, ZENA and Z-Scale are trademarks of Microchip Technology Incorporated in the U.S.A. and other countries.

SQTP is a service mark of Microchip Technology Incorporated in the U.S.A.

GestIC and ULPP are registered trademarks of Microchip Technology Germany II GmbH & Co. & KG, a subsidiary of Microchip Technology Inc., in other countries.

All other trademarks mentioned herein are property of their respective companies.

© 2001-2012, Microchip Technology Incorporated, Printed in the U.S.A., All Rights Reserved.

 Printed on recycled paper.

ISBN: 9781620767993

**QUALITY MANAGEMENT SYSTEM**  
**CERTIFIED BY DNV**  
**== ISO/TS 16949 ==**

*Microchip received ISO/TS-16949:2009 certification for its worldwide headquarters, design and wafer fabrication facilities in Chandler and Tempe, Arizona; Gresham, Oregon and design centers in California and India. The Company's quality system processes and procedures are for its PIC<sup>®</sup> MCUs and dsPIC<sup>®</sup> DSCs, KEELOQ<sup>®</sup> code hopping devices, Serial EEPROMs, microperipherals, nonvolatile memory and analog products. In addition, Microchip's quality system for the design and manufacture of development systems is ISO 9001:2000 certified.*



# MICROCHIP

## Worldwide Sales and Service

### AMERICAS

**Corporate Office**  
2355 West Chandler Blvd.  
Chandler, AZ 85224-6199  
Tel: 480-792-7200  
Fax: 480-792-7277  
Technical Support:  
<http://www.microchip.com/support>  
Web Address:  
[www.microchip.com](http://www.microchip.com)

**Atlanta**  
Duluth, GA  
Tel: 678-957-9614  
Fax: 678-957-1455

**Boston**  
Westborough, MA  
Tel: 774-760-0087  
Fax: 774-760-0088

**Chicago**  
Itasca, IL  
Tel: 630-285-0071  
Fax: 630-285-0075

**Cleveland**  
Independence, OH  
Tel: 216-447-0464  
Fax: 216-447-0643

**Dallas**  
Addison, TX  
Tel: 972-818-7423  
Fax: 972-818-2924

**Detroit**  
Farmington Hills, MI  
Tel: 248-538-2250  
Fax: 248-538-2260

**Indianapolis**  
Noblesville, IN  
Tel: 317-773-8323  
Fax: 317-773-5453

**Los Angeles**  
Mission Viejo, CA  
Tel: 949-462-9523  
Fax: 949-462-9608

**Santa Clara**  
Santa Clara, CA  
Tel: 408-961-6444  
Fax: 408-961-6445

**Toronto**  
Mississauga, Ontario,  
Canada  
Tel: 905-673-0699  
Fax: 905-673-6509

### ASIA/PACIFIC

**Asia Pacific Office**  
Suites 3707-14, 37th Floor  
Tower 6, The Gateway  
Harbour City, Kowloon  
Hong Kong  
Tel: 852-2401-1200  
Fax: 852-2401-3431

**Australia - Sydney**  
Tel: 61-2-9868-6733  
Fax: 61-2-9868-6755

**China - Beijing**  
Tel: 86-10-8569-7000  
Fax: 86-10-8528-2104

**China - Chengdu**  
Tel: 86-28-8665-5511  
Fax: 86-28-8665-7889

**China - Chongqing**  
Tel: 86-23-8980-9588  
Fax: 86-23-8980-9500

**China - Hangzhou**  
Tel: 86-571-2819-3187  
Fax: 86-571-2819-3189

**China - Hong Kong SAR**  
Tel: 852-2943-5100  
Fax: 852-2401-3431

**China - Nanjing**  
Tel: 86-25-8473-2460  
Fax: 86-25-8473-2470

**China - Qingdao**  
Tel: 86-532-8502-7355  
Fax: 86-532-8502-7205

**China - Shanghai**  
Tel: 86-21-5407-5533  
Fax: 86-21-5407-5066

**China - Shenyang**  
Tel: 86-24-2334-2829  
Fax: 86-24-2334-2393

**China - Shenzhen**  
Tel: 86-755-8864-2200  
Fax: 86-755-8203-1760

**China - Wuhan**  
Tel: 86-27-5980-5300  
Fax: 86-27-5980-5118

**China - Xian**  
Tel: 86-29-8833-7252  
Fax: 86-29-8833-7256

**China - Xiamen**  
Tel: 86-592-2388138  
Fax: 86-592-2388130

**China - Zhuhai**  
Tel: 86-756-3210040  
Fax: 86-756-3210049

### ASIA/PACIFIC

**India - Bangalore**  
Tel: 91-80-3090-4444  
Fax: 91-80-3090-4123

**India - New Delhi**  
Tel: 91-11-4160-8631  
Fax: 91-11-4160-8632

**India - Pune**  
Tel: 91-20-2566-1512  
Fax: 91-20-2566-1513

**Japan - Osaka**  
Tel: 81-66-152-7160  
Fax: 81-66-152-9310

**Japan - Yokohama**  
Tel: 81-45-471-6166  
Fax: 81-45-471-6122

**Korea - Daegu**  
Tel: 82-53-744-4301  
Fax: 82-53-744-4302

**Korea - Seoul**  
Tel: 82-2-554-7200  
Fax: 82-2-558-5932 or  
82-2-558-5934

**Malaysia - Kuala Lumpur**  
Tel: 60-3-6201-9857  
Fax: 60-3-6201-9859

**Malaysia - Penang**  
Tel: 60-4-227-8870  
Fax: 60-4-227-4068

**Philippines - Manila**  
Tel: 63-2-634-9065  
Fax: 63-2-634-9069

**Singapore**  
Tel: 65-6334-8870  
Fax: 65-6334-8850

**Taiwan - Hsin Chu**  
Tel: 886-3-5778-366  
Fax: 886-3-5770-955

**Taiwan - Kaohsiung**  
Tel: 886-7-213-7828  
Fax: 886-7-330-9305

**Taiwan - Taipei**  
Tel: 886-2-2508-8600  
Fax: 886-2-2508-0102

**Thailand - Bangkok**  
Tel: 66-2-694-1351  
Fax: 66-2-694-1350

### EUROPE

**Austria - Wels**  
Tel: 43-7242-2244-39  
Fax: 43-7242-2244-393

**Denmark - Copenhagen**  
Tel: 45-4450-2828  
Fax: 45-4485-2829

**France - Paris**  
Tel: 33-1-69-53-63-20  
Fax: 33-1-69-30-90-79

**Germany - Munich**  
Tel: 49-89-627-144-0  
Fax: 49-89-627-144-44

**Italy - Milan**  
Tel: 39-0331-742611  
Fax: 39-0331-466781

**Netherlands - Drunen**  
Tel: 31-416-690399  
Fax: 31-416-690340

**Spain - Madrid**  
Tel: 34-91-708-08-90  
Fax: 34-91-708-08-91

**UK - Wokingham**  
Tel: 44-118-921-5869  
Fax: 44-118-921-5820

11/27/12

Компания «Океан Электроники» предлагает заключение долгосрочных отношений при поставках импортных электронных компонентов на взаимовыгодных условиях!

Наши преимущества:

- Поставка оригинальных импортных электронных компонентов напрямую с производств Америки, Европы и Азии, а так же с крупнейших складов мира;
- Широкая линейка поставок активных и пассивных импортных электронных компонентов (более 30 млн. наименований);
- Поставка сложных, дефицитных, либо снятых с производства позиций;
- Оперативные сроки поставки под заказ (от 5 рабочих дней);
- Экспресс доставка в любую точку России;
- Помощь Конструкторского Отдела и консультации квалифицированных инженеров;
- Техническая поддержка проекта, помощь в подборе аналогов, поставка прототипов;
- Поставка электронных компонентов под контролем ВП;
- Система менеджмента качества сертифицирована по Международному стандарту ISO 9001;
- При необходимости вся продукция военного и аэрокосмического назначения проходит испытания и сертификацию в лаборатории (по согласованию с заказчиком);
- Поставка специализированных компонентов военного и аэрокосмического уровня качества (Xilinx, Altera, Analog Devices, Intersil, Interpoint, Microsemi, Actel, Aeroflex, Peregrine, VPT, Syfer, Eurofarad, Texas Instruments, MS Kennedy, Miteq, Cobham, E2V, MA-COM, Hittite, Mini-Circuits, General Dynamics и др.);

Компания «Океан Электроники» является официальным дистрибьютором и эксклюзивным представителем в России одного из крупнейших производителей разъемов военного и аэрокосмического назначения «JONHON», а так же официальным дистрибьютором и эксклюзивным представителем в России производителя высокотехнологичных и надежных решений для передачи СВЧ сигналов «FORSTAR».



## JONHON

«JONHON» (основан в 1970 г.)

Разъемы специального, военного и аэрокосмического назначения:

(Применяются в военной, авиационной, аэрокосмической, морской, железнодорожной, горно- и нефтедобывающей отраслях промышленности)

«FORSTAR» (основан в 1998 г.)

ВЧ соединители, коаксиальные кабели, кабельные сборки и микроволновые компоненты:

(Применяются в телекоммуникациях гражданского и специального назначения, в средствах связи, РЛС, а так же военной, авиационной и аэрокосмической отраслях промышленности).



Телефон: 8 (812) 309-75-97 (многоканальный)

Факс: 8 (812) 320-03-32

Электронная почта: [ocean@oceanchips.ru](mailto:ocean@oceanchips.ru)

Web: <http://oceanchips.ru/>

Адрес: 198099, г. Санкт-Петербург, ул. Калинина, д. 2, корп. 4, лит. А