

FIRST CIRCUIT MARK
(NOT SHOWING ON 4
AND 6 CIRCUITS SERIES)

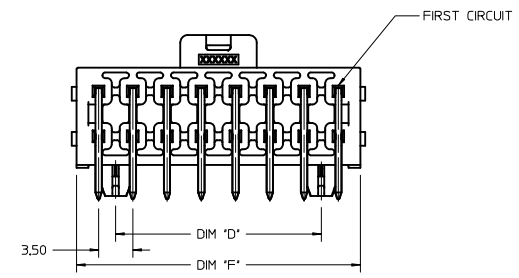

- NOTES:
- MATERIAL :
HOUSING
OPTION 1: LCP E130i BLACK
OPTION 2: LCP E130i NATURAL
TERMINAL: COPPER ALLOY
 - PLATING FINISH:
OPTION 1 - 1.5µm(60µin)-2.5µm(100µin) TIN OVER
1.25µm(50µin)-2.5µm(100µin) NICKEL OVERALL
OPTION 2 - 0.35µm(15µin) GOLD CONTACT AREA,
1.5µm(60µin)-2.5µm(100µin) TIN TAIL AREA OVER
1.25µm(50µin)-2.5µm(100µin) NICKEL OVERALL
OPTION 3 - 0.70µm(30µin) GOLD CONTACT AREA,
1.5µm(60µin)-2.5µm(100µin) TIN TAIL AREA OVER
1.25µm(50µin)-2.5µm(100µin) NICKEL OVERALL
 - PARTS TO BE PACKAGED PER PK-172316-9001
 - PRODUCT SPECIFICATION PS-172323-0001
 - PART MATES WITH MOLEX RECEPTACLE HOUSING
172258 AND 172262
 - PART CONFORMS TO CLASS 'C' REQUIREMENTS OF SPECIFICATION
PS-45499-002 WITH 0.13 MM MAXIMUM FLASH ALLOWED IN CORE
HOLES AND FRONT SURFACE.
 - DISCOLORATION IN THE BANDOLIER AREA OF THE PIN IS
INHERENT TO THE PLATING PROCESS AND IS DUE TO THE MASKING
EFFECT OF THE CARRIER. THIS DISCOLORATION IS IN A NON-FUNCTIONAL
AREA OF THE PIN AND WILL NOT AFFECT THE PERFORMANCE OF THE
HEADER ASSEMBLY.
 - ASSEMBLY SPECIFICATION: AS-172323-0001

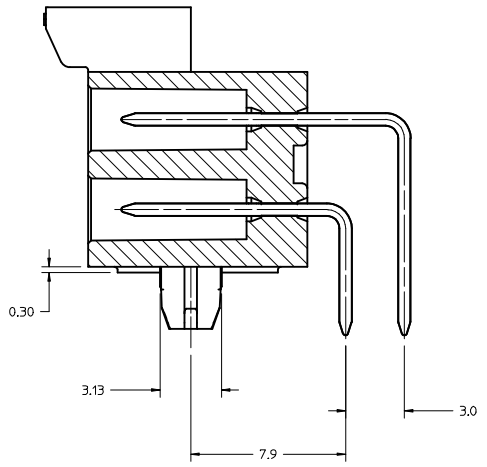
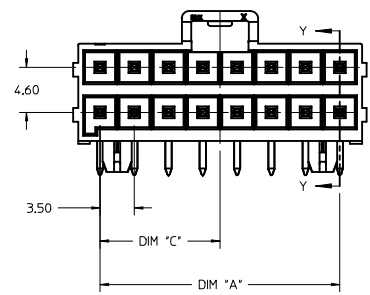
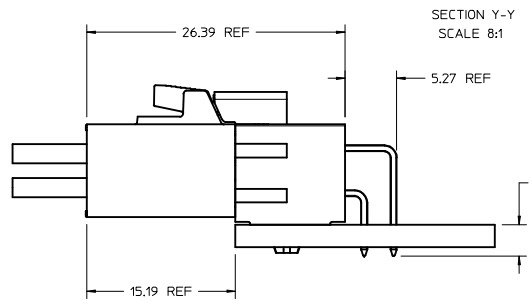

SECTION Y-Y
SCALE 8:1

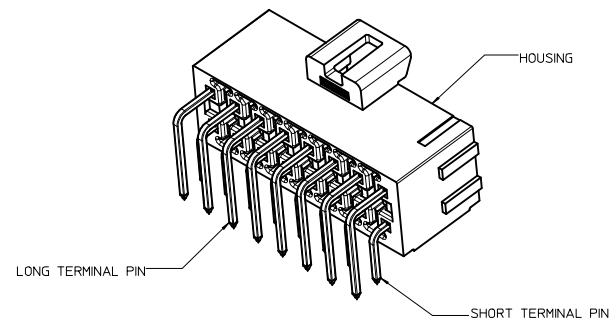

X RELEASE IEC NO: UCP2015-4103 DRAWN BY: DRWN:DRSCA CHKD: CHYD: APPR:RHODGE 2015/04/14 2015/04/15	QUALITY SYMBOLS	GENERAL TOLERANCES (UNLESS SPECIFIED)	DIMENSION STYLE	SCALE	DESIGN UNITS	THIRD ANGLE PROJECTION
	▽=0	4 PLACES ± mm	MM ONLY	4:1	METRIC	☉
	▽=0	3 PLACES ± 0.25				
	▽=0	1 PLACE ± 0.5				
		ANGULAR ±1/2°	DRAWN BY DATE			
		DRAFT WHERE APPLICABLE MUST REMAIN WITHIN DIMENSIONS	DROSCA 2014/03/06			
			CHECKED BY DATE			
			APPROVED BY DATE			
			JCOMERCI 2014/04/24			
			MATERIAL NO.	DOCUMENT NO.		
			SEE CHART	SD-172316-1000		
			SIZE D			
			THIS DRAWING CONTAINS INFORMATION THAT IS PROPRIETARY TO MOLEX INCORPORATED AND SHOULD NOT BE USED WITHOUT WRITTEN PERMISSION			

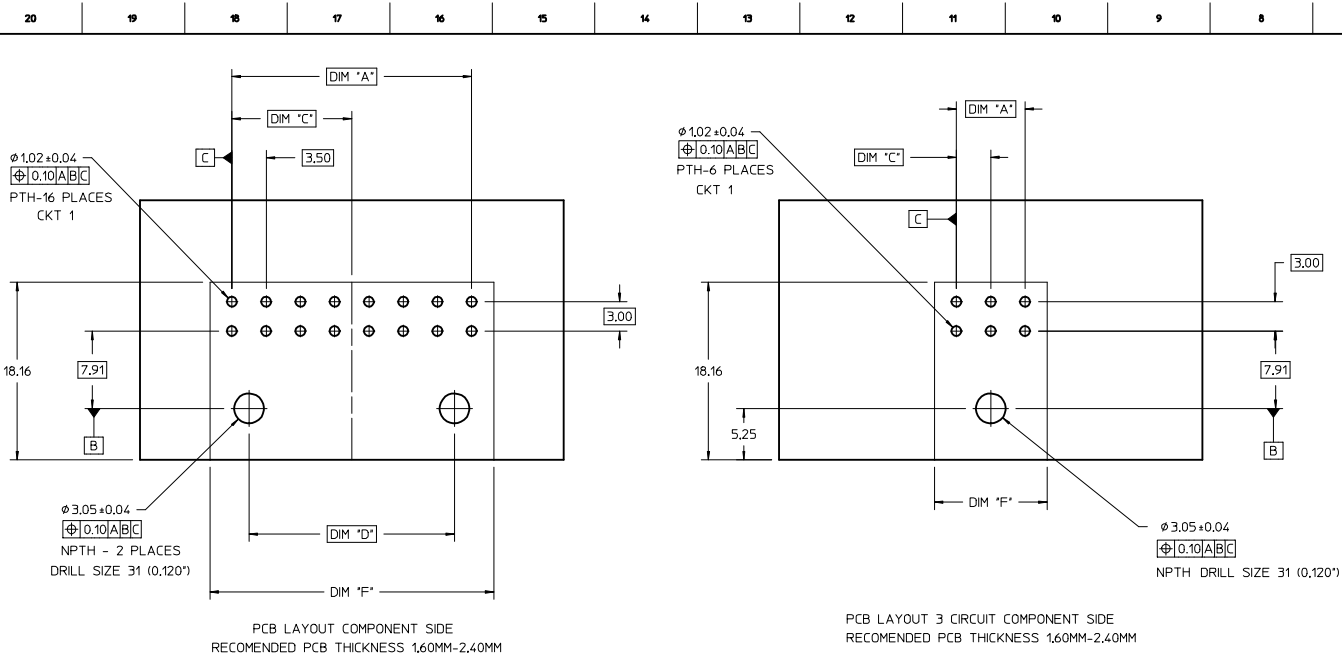

PCB LAYOUT COMPONENT SIDE
RECOMMENDED PCB THICKNESS 1.60MM-2.40MM

PCB LAYOUT 3 CIRCUIT COMPONENT SIDE
RECOMMENDED PCB THICKNESS 1.60MM-2.40MM

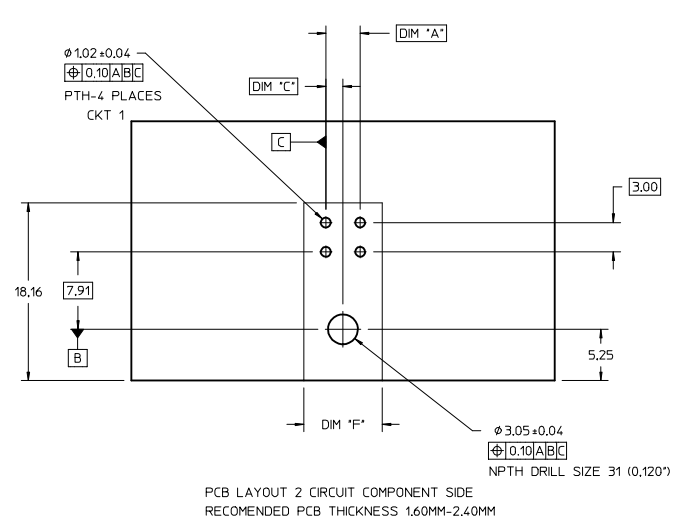

PCB LAYOUT 2 CIRCUIT COMPONENT SIDE
RECOMMENDED PCB THICKNESS 1.60MM-2.40MM

NOTE: DATUM -A- IS ON COMPONENT SIDE PCB

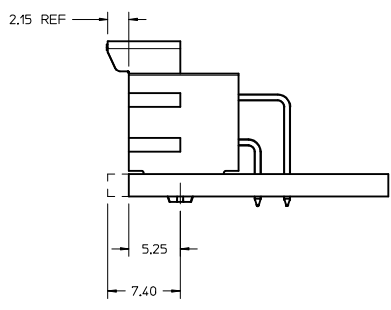

OPTION 1: LATCH FLUSH WITH PCB EDGE
OPTION 2: HOUSING BODY FLUSH WITH PCB EDGE

TIN PLATING							
PART NO.	COLOR	CIRCUIT SIZE	KEY OPTION	DIM A	DIM F	DIM C	DIM D
172316-1104	BLACK	4	KEY A	3.50	8.00	1.75	0.00
172316-1106	BLACK	6	KEY A	7.00	11.50	3.50	0.00
172316-1108	BLACK	8	KEY A	10.50	15.00	5.25	7.00
172316-1110	BLACK	10	KEY A	14.00	18.50	7.00	10.50
172316-1112	BLACK	12	KEY A	17.50	22.00	8.75	14.00
172316-1114	BLACK	14	KEY A	21.00	25.50	10.50	17.50
172316-1116	BLACK	16	KEY A	24.50	29.00	12.25	21.00
172316-2104	NATURAL	4	KEY B	3.50	8.00	1.75	0.00
172316-2106	NATURAL	6	KEY B	7.00	11.50	3.50	0.00
172316-2108	NATURAL	8	KEY B	10.50	15.00	5.25	7.00
172316-2110	NATURAL	10	KEY B	14.00	18.50	7.00	10.50
172316-2112	NATURAL	12	KEY B	17.50	22.00	8.75	14.00
172316-2114	NATURAL	14	KEY B	21.00	25.50	10.50	17.50
172316-2116	NATURAL	16	KEY B	24.50	29.00	12.25	21.00

15 MICROINCH GOLD PLATING							
PART NO.	COLOR	CIRCUIT SIZE	KEY OPTION	DIM A	DIM F	DIM C	DIM D
172316-1204	BLACK	4	KEY A	3.50	8.00	1.75	0.00
172316-1206	BLACK	6	KEY A	7.00	11.50	3.50	0.00
172316-1208	BLACK	8	KEY A	10.50	15.00	5.25	7.00
172316-1210	BLACK	10	KEY A	14.00	18.50	7.00	10.50
172316-1212	BLACK	12	KEY A	17.50	22.00	8.75	14.00
172316-1214	BLACK	14	KEY A	21.00	25.50	10.50	17.50
172316-1216	BLACK	16	KEY A	24.50	29.00	12.25	21.00
172316-2204	NATURAL	4	KEY B	3.50	8.00	1.75	0.00
172316-2206	NATURAL	6	KEY B	7.00	11.50	3.50	0.00
172316-2208	NATURAL	8	KEY B	10.50	15.00	5.25	7.00
172316-2210	NATURAL	10	KEY B	14.00	18.50	7.00	10.50
172316-2212	NATURAL	12	KEY B	17.50	22.00	8.75	14.00
172316-2214	NATURAL	14	KEY B	21.00	25.50	10.50	17.50
172316-2216	NATURAL	16	KEY B	24.50	29.00	12.25	21.00

30 MICROINCH GOLD PLATING							
PART NO.	COLOR	CIRCUIT SIZE	KEY OPTION	DIM A	DIM F	DIM C	DIM D
172316-1304	BLACK	4	KEY A	3.50	8.00	1.75	0.00
172316-1306	BLACK	6	KEY A	7.00	11.50	3.50	0.00
172316-1308	BLACK	8	KEY A	10.50	15.00	5.25	7.00
172316-1310	BLACK	10	KEY A	14.00	18.50	7.00	10.50
172316-1312	BLACK	12	KEY A	17.50	22.00	8.75	14.00
172316-1314	BLACK	14	KEY A	21.00	25.50	10.50	17.50
172316-1316	BLACK	16	KEY A	24.50	29.00	12.25	21.00
172316-2304	NATURAL	4	KEY B	3.50	8.00	1.75	0.00
172316-2306	NATURAL	6	KEY B	7.00	11.50	3.50	0.00
172316-2308	NATURAL	8	KEY B	10.50	15.00	5.25	7.00
172316-2310	NATURAL	10	KEY B	14.00	18.50	7.00	10.50
172316-2312	NATURAL	12	KEY B	17.50	22.00	8.75	14.00
172316-2314	NATURAL	14	KEY B	21.00	25.50	10.50	17.50
172316-2316	NATURAL	16	KEY B	24.50	29.00	12.25	21.00

SEE PAGE 1 IEC NO: UCP2015-4103 DRAWN BY: DROSCA CHKD: APPR: RHODGE DATE: 2015/04/14 DATE: 2015/04/15	QUALITY SYMBOLS ▽=0 ▽=0 ▽=0	GENERAL TOLERANCES (UNLESS SPECIFIED) <table border="1"> <tr><th></th><th>mm</th><th>INCH</th></tr> <tr><td>4 PLACES</td><td>±---</td><td>±---</td></tr> <tr><td>3 PLACES</td><td>±---</td><td>±---</td></tr> <tr><td>2 PLACES</td><td>±0.25</td><td>±---</td></tr> <tr><td>1 PLACE</td><td>±0.5</td><td>±---</td></tr> <tr><td>0 PLACE</td><td>±---</td><td>±---</td></tr> </table>		mm	INCH	4 PLACES	±---	±---	3 PLACES	±---	±---	2 PLACES	±0.25	±---	1 PLACE	±0.5	±---	0 PLACE	±---	±---	DIMENSION STYLE MM ONLY	SCALE 4:1	DESIGN UNITS METRIC	THIRD ANGLE PROJECTION
		mm	INCH																					
	4 PLACES	±---	±---																					
	3 PLACES	±---	±---																					
2 PLACES	±0.25	±---																						
1 PLACE	±0.5	±---																						
0 PLACE	±---	±---																						
DRAWN BY: DROSCA DATE: 2014/03/06 CHECKED BY:	TITLE ULTRA-FIT R/A HEADER 4-16 CKTS DUAL ROW	APPROVED BY: JCOMERCI DATE: 2014/04/24	MATERIAL NO. SEE PAGE 1	DOCUMENT NO. SD-172316-1000	SHEET NO. 2 OF 3																			
DRAFT WHERE APPLICABLE MUST REMAIN WITHIN DIMENSIONS	ANGULAR ±1/2°	THIS DRAWING CONTAINS INFORMATION THAT IS PROPRIETARY TO MOLEX INCORPORATED AND SHOULD NOT BE USED WITHOUT WRITTEN PERMISSION																						

20 19 18 17 16 15 14 13 12 11 10 9 8 7 6 5 4 3 2 1

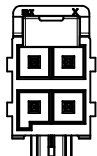

4 CKT

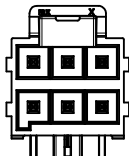

6 CKT

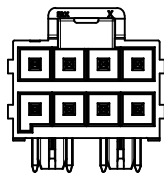

8 CKT

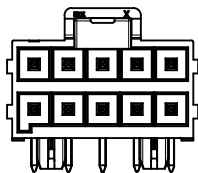

10 CKT

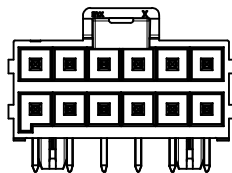

12 CKT

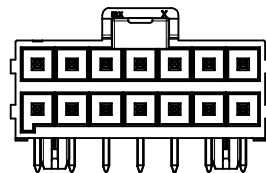

14 CKT

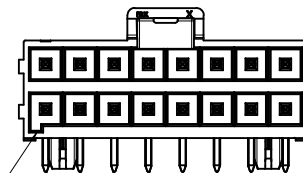

16 CKT

KEY A
(BLACK)

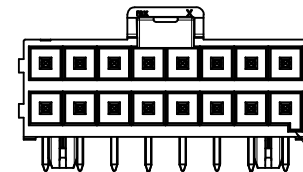

KEY B
(NATURAL)

<p>SEE PAGE 1 IEC NO: UCF2015-4103 DRAWN BY: DROSCA 2015/04/14 CHKD: CHYK APPR: RHODGE 2015/04/15</p>	QUALITY SYMBOLS	GENERAL TOLERANCES (UNLESS SPECIFIED)	DIMENSION STYLE	SCALE	DESIGN UNITS	THIRD ANGLE PROJECTION	
	▽=0	4 PLACES ± mm ± INCH	MM ONLY	4:1	METRIC	☉	
	▽=0	3 PLACES ± 0.25					
	▽=0	2 PLACES ± 0.5					
		ANGULAR ±1/2°					
		DRAFT WHERE APPLICABLE MUST REMAIN WITHIN DIMENSIONS					
			DRAWN BY: DROSCA DATE: 2014/03/06			TITLE: ULTRA-FIT R/A HEADER 4-16 CKTS DUAL ROW	
			CHECKED BY: DATE:				
			APPROVED BY: JCOMERCI DATE: 2014/04/24				
			MATERIAL NO. SEE PAGE 1			DOCUMENT NO. SD-172316-1000	
			SIZE D			SHEET NO. 3 OF 3	
			THIS DRAWING CONTAINS INFORMATION THAT IS PROPRIETARY TO MOLEX INCORPORATED AND SHOULD NOT BE USED WITHOUT WRITTEN PERMISSION				

19 18 17 16 15 14 13 12 11 10 9 8 7 6 5 4 3 2 1

Компания «Океан Электроники» предлагает заключение долгосрочных отношений при поставках импортных электронных компонентов на взаимовыгодных условиях!

Наши преимущества:

- Поставка оригинальных импортных электронных компонентов напрямую с производств Америки, Европы и Азии, а так же с крупнейших складов мира;
- Широкая линейка поставок активных и пассивных импортных электронных компонентов (более 30 млн. наименований);
- Поставка сложных, дефицитных, либо снятых с производства позиций;
- Оперативные сроки поставки под заказ (от 5 рабочих дней);
- Экспресс доставка в любую точку России;
- Помощь Конструкторского Отдела и консультации квалифицированных инженеров;
- Техническая поддержка проекта, помощь в подборе аналогов, поставка прототипов;
- Поставка электронных компонентов под контролем ВП;
- Система менеджмента качества сертифицирована по Международному стандарту ISO 9001;
- При необходимости вся продукция военного и аэрокосмического назначения проходит испытания и сертификацию в лаборатории (по согласованию с заказчиком);
- Поставка специализированных компонентов военного и аэрокосмического уровня качества (Xilinx, Altera, Analog Devices, Intersil, Interpoint, Microsemi, Actel, Aeroflex, Peregrine, VPT, Syfer, Eurofarad, Texas Instruments, MS Kennedy, Miteq, Cobham, E2V, MA-COM, Hittite, Mini-Circuits, General Dynamics и др.);

Компания «Океан Электроники» является официальным дистрибьютором и эксклюзивным представителем в России одного из крупнейших производителей разъемов военного и аэрокосмического назначения «JONHON», а так же официальным дистрибьютором и эксклюзивным представителем в России производителя высокотехнологичных и надежных решений для передачи СВЧ сигналов «FORSTAR».



JONHON

«JONHON» (основан в 1970 г.)

Разъемы специального, военного и аэрокосмического назначения:

(Применяются в военной, авиационной, аэрокосмической, морской, железнодорожной, горно- и нефтедобывающей отраслях промышленности)

«FORSTAR» (основан в 1998 г.)

ВЧ соединители, коаксиальные кабели, кабельные сборки и микроволновые компоненты:

(Применяются в телекоммуникациях гражданского и специального назначения, в средствах связи, РЛС, а так же военной, авиационной и аэрокосмической отраслях промышленности).



Телефон: 8 (812) 309-75-97 (многоканальный)

Факс: 8 (812) 320-03-32

Электронная почта: ocean@oceanchips.ru

Web: <http://oceanchips.ru/>

Адрес: 198099, г. Санкт-Петербург, ул. Калинина, д. 2, корп. 4, лит. А