



Typical units

Output (V)	Current (A)	Input (Vdc)
3.3	60	36-75
5	60	
12	35	

### FEATURES

- Advanced Bus Converter industry standard quarter-brick with digital PMBus interface
- Optional standard five pin quarter-brick
- High efficiency, 95.2% (typ)
- Superior thermal performance
- Fast dynamic response
- $\pm 2\%$  Vout setting accuracy
- 2250Vdc input to output isolation voltage (functional)
- Optional baseplate (B option)
- PMBus™ Revision 1.2 compliant
- Voltage droop load sharing for parallel operation
- Certified to UL/EN/IEC 60950-1, CAN/CSA-C22.2 No. 60950-1, 2nd Edition, safety approvals and EN55022/CISPR22 standards (pending)

### PRODUCT OVERVIEW

Murata Power Solutions is introducing the first in a series of digitally controlled DC-DC converters that are based on a 32-bit ARM processor. The DBQ series provides a fully regulated, digitally controlled DC output in a ¼-brick format that will support the evolving Advanced Bus Converter (ABC) industry standard footprint for isolated board mounted power modules. The DBQ series supports advances in power conversion technology including a digital interface supporting the PMBus protocol for communications to power modules.

The DBQ series also incorporates a “droop” load sharing option that allows connecting two or more

units together in parallel for demanding power-hungry applications or to provide redundancy in high reliability applications. The converter also offers high input to output isolation of 2250 VDC as required for Power over Ethernet (PoE) applications.

The DBQ series is suitable for applications covering MicroTCA, servers and storage applications, networking equipment, telecommunications equipment, Power over Ethernet (PoE), fan trays, wireless networks, wireless pre-amplifiers, and industrial and test equipment, along with other applications requiring a regulated 12V.

### Power Management (PMBus Options)

- Configurable soft-start/stop
- Configurable output voltage (Vout) and voltage margins (Margin low and Margin high)
- Configurable protection limits for OVP, input over voltage, input under voltage, over current, on/off, and temperature.
- Module Status monitor Vout, Iout, Vin, Temp, Power good, and On/Off.
- System status monitor (Vout, Iout, Vin and Temp over time)

### Applications

- Distributed power architectures
- Intermediate bus voltage applications
- Servers and storage applications
- Network equipment



### PERFORMANCE SPECIFICATIONS SUMMARY AND ORDERING GUIDE ①

Root Model	Output						Input				Efficiency		Dimensions (open frame, max.)		
	V <sub>OUT</sub> (V)	I <sub>OUT</sub> (A, max)	Total Power (W)	Ripple & Noise (mVp-p)		Regulation (max.)		V <sub>IN</sub> Nom. (V)	Range (V)	I <sub>IN, min.</sub> load (mA)	I <sub>IN, full</sub> load (A)	Min.	Typ.	(inches)	(mm)
				Typ.	Max.	Line (mV)	Load (mV)								
DBQ0360V2	3.3	60	198	40	150	20	15	48	36-75	50	4.43	92.0%	93.2%	2.3x1.45x0.48 max.	58.4x36.83x12.19
DBQ0260V2	5	60	300	50	150	30	25	48	36-75	50	6.59	93.0%	94.8%	2.3x1.45x0.48 max.	58.4x36.83x12.19
DBQ0135V2	12	35	420	100	150	75	45	48	36-75	75	9.19	94%	95.2%	2.3x1.45x0.48 max.	58.4x36.83x12.19
DVQ0360V2 ②	3.3	60	198	40	150	20	15	48	36-75	50	4.43	92.0%	93.2%	2.3x1.45x0.48 max.	58.4x36.83x12.19
DVQ0260V2 ②	5	60	300	50	150	30	25	48	36-75	50	6.59	93.0%	94.8%	2.3x1.45x0.48 max.	58.4x36.83x12.19
DVQ0135V2 ②	12	35	420	100	150	75	45	48	36-75	75	9.19	94%	95.2%	2.3x1.45x0.48 max.	58.4x36.83x12.19

① Typical at TA = +25°C under nominal line voltage and full-load conditions. All models are specified with external 1µF and 10µF capacitors in parallel across their output pins.

② DVQ models do not have the PMBus feature.

### DIGITAL CONTROL BRICK PART NUMBER FORMAT

Description	Part Number Structure													Definition and Options				
Product Family	D	X																DB = Full Featured Digital Bus converter, DV = NO PMBus, NO Sense & Trim Pins
Form Factor			Q															Q = Quarter Brick
Vout ①				0	1													01 = 12Vout, 02 = 5Vout, 03 = 3.3Vout (Without PMBus Vout cannot be changed)
Output Current						3	5											Max Iout in Amps
Vin Range								V	2									V2 = 36-75V
Logic ①										N								N = Negative, P = Positive
Pin Length ②											X							1 = 0.110" (cut), 2 = 0.145" (cut), Omit for standard shown in the mechanical drawings
Mechanical Configuration												B						B = Baseplate, Omit for Open Frame (Standard Configuration)
Load Sharing													S					S = Load Sharing, Omit for Standard (Standard Configuration)
Specific Customer Configuration														X	X			Customer Code, Omit for Standard
RoHS																	C	RoHS 6/6 Compliant

① PMBus Configurable

② Minimum order quantity is required. Samples available with standard pin length only.

Note: Some model number combinations may not be available. See website or contact your local Murata sales representative.

#### Part Number Example

DBQ0135V2NBSC = Full Featured Digital 1/4 Brick, 12Vout, 35A, 36-75Vin, Negative logic, Baseplate, Load Sharing, RoHS 6/6 compliant

### EVALUATION BOARD AVAILABLE FROM MURATA POWER SOLUTIONS

Part Number	Application Note	USB Adaptor Part Number	GUI Software Application Note
MPS-TD001	<a href="http://www.murata-ps.com/data/apnotes/dcan-63.pdf">www.murata-ps.com/data/apnotes/dcan-63.pdf</a>	MPS-AD001	<a href="http://www.murata-ps.com/data/apnotes/dcan-63.pdf">www.murata-ps.com/data/apnotes/dcan-63.pdf</a>

Contact your local Murata sales representative for ordering details.

### DBQ0360V2: 3.3V/60A FUNCTIONAL SPECIFICATIONS (VOLTAGE APPLIED TO SCL SDA SMBALERT AND ON/OFF 2, MIN: -0.3V MAX: 3.6V)

ABSOLUTE MAXIMUM RATINGS	Conditions ①	Minimum	Typical/Nominal	Maximum	Units
Input Voltage, Continuous		0		80	Vdc
Input Voltage, Transient	100 mS max. duration			100	Vdc
Isolation Voltage	Input to output			2250	Vdc
On/Off Remote Control	Power on, referred to -Vin	0		13.5	Vdc
Output Power		0		200	W
Output Current	Current-limited, no damage, short-circuit protected	0		60	A
Storage Temperature Range	Vin = Zero (no power)	-55		125	°C

Absolute maximums are stress ratings. Exposure of devices to greater than any of these conditions may adversely affect long-term reliability. Proper operation under conditions other than those listed in the Performance/Functional Specifications Table is not implied nor recommended.

#### INPUT

Operating voltage range (V2)		36	48	75	Vdc
Start-up threshold	(Default, configurable via PMBus)	33	34	35	Vdc
Undervoltage shutdown	(Default, configurable via PMBus)	31	32	34	Vdc
Overvoltage shutdown	(Default, configurable via PMBus)	NA	NA	NA	Vdc
Overvoltage Recover	(Default, configurable via PMBus)	NA	NA	NA	Vdc
Internal Filter Type			Pi		
External Input fuse			20		A
Input current					
Full Load Conditions	Vin = nominal		4.43	4.48	A
Low Line input current	Vin = minimum		5.79	5.97	A
Inrush Transient	Vin = 48V.		TBD	TBD	A <sup>2</sup> -Sec.
Short Circuit input current			0.05	0.1	A
No Load input current	Iout = minimum, unit=ON		50	100	mA
Shut-Down input current(Off, UV, OT)			TBD	TBD	mA
Back Ripple Current			TBD	TBD	mAp-p

#### GENERAL and SAFETY

Efficiency	Vin=48V, full load (V2)	92	93.2		%
Isolation Voltage	Input to output			2250	Vdc
	Input to Baseplate			1500	Vdc
	Output to Baseplate			1500	Vdc
Insulation Safety Rating			functional		
Isolation Resistance			10		MΩ
Isolation Capacitance			1000		pF
Safety	Certified to UL-60950-1, CSA-C22.2 No.60950-1, IEC/EN60950-1, 2nd edition (pending)		Yes		
Calculated MTBF	Per Telcordia SR-332, Issue 2, Method 1, Class 1, Ground Fixed, Tcase=+25°C		1800		Hours x 10 <sup>3</sup>

#### DYNAMIC CHARACTERISTICS

Switching Frequency (Configurable via PMBus)					
Fixed Frequency Control			150		KHz
Variable Frequency Control (Default)			NA		KHz
Turn On Time (Default, Configurable via PMBus)					
Vin On to Vout Regulated				45	mS
Remote On to Vout Regulated				25	mS
Vout Rise Time (Default, Configurable via PMBus)					
From 0%~100%			20		mS
Vout Fall Time of Regulated Off (Default, Configurable via PMBus)					
From 100%~0%			13		mS
Dynamic Load Response	50-75-50%, 1A/us, within 1% of Vout		TBD	TBD	μSec
Dynamic Load Peak Deviation	same as above		TBD	TBD	mV

### DBQ0360V2 FUNCTIONAL SPECIFICATIONS (CONT.)

FEATURES and OPTIONS	Conditions ①	Minimum	Typical/Nominal	Maximum	Units
<b>Remote On/Off Control</b>					
<b>Primary On/Off control (designed to be driving with an open collector logic, Voltages referenced to -Vin)</b>					
"P" suffix:					
Positive Logic, ON state	ON = pin open or external voltage	3.5		13.5	V
Positive Logic, OFF state	OFF = ground pin or external voltage	0		0.8	V
Control Current	open collector/drain		0.1	0.2	mA
"N" suffix:					
Negative Logic, ON state	ON = ground pin or external voltage	-0.1		0.8	V
Negative Logic, OFF state	OFF = pin open or external voltage	3.5		13.5	V
Control Current	open collector/drain		0.1	0.2	mA
<b>OUTPUT</b>					
Total Output Power		0	198	200	W
<b>Voltage</b>					
Setting Accuracy	At 100% load, no trim, all conditions	3.27	3.3	3.33	Vdc
Output Adjust Range	Configurable via PMBus	2.2		3.6	Vdc
Overvoltage Protection	Configurable via PMBus		4		Vdc
Voltage Droop	Default, configurable via PMBus		0		mΩ
<b>Current</b>					
Output Current Range		0	60	60	A
Minimum Load			No minimum load		
Current Limit Inception ②	98% of Vnom., after warmup, Configurable via PMBus			70	A
<b>Short Circuit</b>					
Short Circuit Current	Hiccup technique, autorecovery within 1% of Vout		0.4	1	A
Short Circuit Duration (remove short for recovery)	Output shorted to ground, no damage		Continuous		
Short circuit protection method, default response, configurable via PMBus	Hiccup current limiting		Non-latching		
<b>Regulation ③</b>					
Line Regulation (V2)	Vin = 36-75, Vout = nom., full load			20	mV
Load Regulation (V2)	Iout = min. to max., Vin = nom.			15	mV
Ripple and Noise	5 Hz- 20 MHz BW, Cout = 1μF paralleled with 10μF		40	150	mV pk-pk
Temperature Coefficient	At all outputs		0.01	0.02	% of Vnom./°C
Maximum Output Capacitance	Low ESR			10,000	μF
<b>Power Good—Negative logic (Configurable via PMBus)</b>					
Power good high stage voltage		2.4		3.6	Vdc
Power good low stage voltage		0		0.4	Vdc
Out voltage for power good off triggering	Configurable via PMBus	2	2.3	2.5	Vdc
Out Voltage for power good on triggering	Configurable via PMBus	2.6	2.8	3	Vdc

### DBQ0360V2 FUNCTIONAL SPECIFICATIONS (CONT.)

PMBus	Conditions ①	Minimum	Typical/Nominal	Maximum	Units
<b>PMBus GENERAL</b>					
PMBus REV. 1.2. SMBALERT# is supported. PEC is supported. Linear data format used.					
Bus speed				400	kHz
Logic high input		2		3.3	Vdc
Logic low input		0		0.8	Vdc
Logic high output		2.4			Vdc
Logic low output				0.4	Vdc
<b>PMBus ADDRESSING</b>					
If the calculated PMBus address is 0d, 11d or 12d, SA0 or SA1 lefts open, default PMBus address 119d is assigned instead. PMBus address = 8x(SA0 value) + (SA1 value). SA0, SA1 value VS resistor connected to GND.					
0			10		kΩ
1			22		kΩ
2			33		kΩ
3			47		kΩ
4			68		kΩ
5			100		kΩ
6			150		kΩ
7			220		kΩ
<b>PMBus MONITORING ACCURACY</b>					
VIN_READ		-2		2	%
VOUT_READ		-1		1	%
IOUT_READ (> = 10A)		-5		5	%
IOUT_READ (<10A)		-1		1	A
TEMP_READ		5		5	°C
<b>DIGITAL INTERFACE SPECIFICATIONS (PMBUS MONITORING &amp; FUNCTIONAL DESCRIPTION)</b>					
<b>Fault Protection Specifications</b>					
Output Voltage, Over Voltage protection, OVP	Factory default		4		V
VOUT_OV_FAULT_LIMIT, Configurable via PMBus	>VOUT_OV_WARN_LIMIT	3		4	V
	Restart delay (default, Configurable via PMBus)		500		ms
Input Voltage, Input Over Voltage Protection	Factory default		NA		V
	Setpoint accuracy				%
VIN_OV_FAULT_LIMIT (Configurable via PMBus) ④	>VIN_OV_WARN_LIMIT		NA		V
	Restart delay (default, Configurable via PMBus)				ms
Input Voltage, Input Under Voltage Protection, UVLO	Factory default		32		V
	Setpoint accuracy	-2		2	%
VIN_UV_FAULT_LIMIT (Configurable via PMBus) ④	<VIN_UV_WARN_LIMIT <VIN_OV_FAULT_LIMIT		32	75	V
	Restart delay (default, Configurable via PMBus)		100		ms
Over Current Protection, OCP	Setpoint accuracy (Io)	-2.5		2.5	%
	(factory default)		70		A
IOUT_OC_FAULT_LIMIT (Configurable via PMBus) ④	>IOUT_OC_WARN_LIMIT	0		75	A
	Restart delay (default, Configurable via PMBus)		100		ms
Over Temperature Protection, OTP	OT_FAULT_LIMIT (factory default)		120		°C
OT_FAULT_LIMIT (Configurable via PMBus) ④	>OT_WARN_LIMIT	0	30	150	°C
	OTP accuracy (factory default)	5		5	°C
	Restart delay (default, Configurable via PMBus)		500		ms

### DBQ0360V2 FUNCTIONAL SPECIFICATIONS (CONT.)

MECHANICAL	Conditions ①	Minimum	Typical/Nominal	Maximum	Units
Outline Dimensions (open frame)			2.3 x 1.45 x 0.48		Inches
(Please refer to outline drawing)	L x W x H		58.4 x 36.83 x 12.19		mm
Outline Dimensions (with baseplate)			2.3 x 1.45 x 0.50		Inches
			58.4 x 36.80 x 12.7		mm
Weight (open frame)			TBD		Ounces
					Grams
Weight (with baseplate)			TBD		Ounces
					Grams
Through Hole Pin Diameter			0.04 & 0.062		Inches
			1.016 & 1.575		mm
Digital Interface Pin Diameter			0.02		
			0.5		
Through Hole Pin Material			Copper alloy		
TH Pin Plating Metal and Thickness	Nickel subplate		98.4-299		μ-inches
	Gold overplate		4.7-19.6		μ-inches
ENVIRONMENTAL					
Operating Ambient Temperature Range	with derating	-40		85	°C
Operating Baseplate Temperature		-40		110	°C
Storage Temperature	Vin = Zero (no power)	-55		125	°C
Thermal Protection/Shutdown (with "B" Suffix, default value, Configurable via PMBUS)	Configurable Via PMBus		120		°C
Electromagnetic Interference Conducted, EN55022/CISPR22	External filter required; see emissions performance test.		B		Class
RoHS rating			RoHS-6		

### Notes

- ① Typical at TA = +25°C under nominal line voltage and full-load conditions. All models are specified with external 1μF and 10μF capacitors in parallel across their output pins. All values are default, unless otherwise noted.
- ② Over-current protection is non-latching with auto recovery (hiccup).
- ③ Regulation specifications describe the output voltage changes as the line voltage or load current is varied from its nominal or midpoint value to either extreme.
- ④ See Operating information section.

**PERFORMANCE DATA**

Efficiency vs. Line Voltage and Load Current @ +25°C

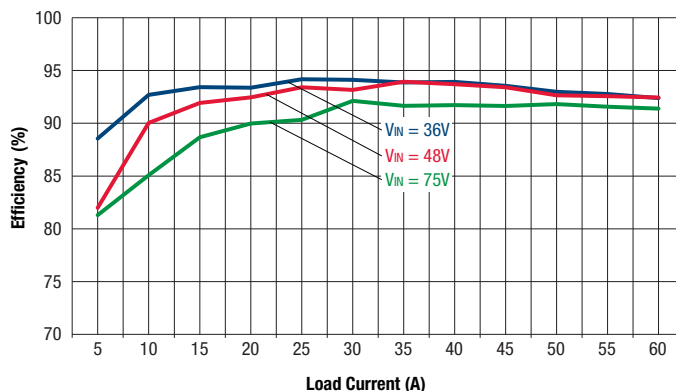

Maximum Current Temperature Derating with baseplate  
(Vin = 48V, airflow from Vin to Vout)



Maximum Current Temperature Derating with baseplate  
(Vin = 48V, airflow from Vin- to Vin+)



### DBQ0260V2: 5V/60A FUNCTIONAL SPECIFICATIONS (VOLTAGE APPLIED TO SCL SDA SMBALERT AND ON/OFF 2, MIN: -0.3V MAX: 3.6V)

ABSOLUTE MAXIMUM RATINGS	Conditions ①	Minimum	Typical/Nominal	Maximum	Units
Input Voltage, Continuous		0		80	Vdc
Input Voltage, Transient	100 mS max. duration			100	Vdc
Isolation Voltage	Input to output			2250	Vdc
On/Off Remote Control	Power on, referred to -Vin	0		13.5	Vdc
Output Power		0		303	W
Output Current	Current-limited, no damage, short-circuit protected	0		60	A
Storage Temperature Range	Vin = Zero (no power)	-55		125	°C

Absolute maximums are stress ratings. Exposure of devices to greater than any of these conditions may adversely affect long-term reliability. Proper operation under conditions other than those listed in the Performance/Functional Specifications Table is not implied nor recommended.

INPUT					
Operating voltage range (V2)		36	48	75	Vdc
Start-up threshold	(Default, configurable via PMBus)	33	34	35	Vdc
Undervoltage shutdown	(Default, configurable via PMBus)	31	32	34	Vdc
Overvoltage shutdown	(Default, configurable via PMBus)	NA	NA	NA	Vdc
Overvoltage Recover	(Default, configurable via PMBus)	NA	NA	NA	Vdc
Internal Filter Type			Pi		
External Input fuse			20		A
Input current					
Full Load Conditions	Vin = nominal		6.59	6.72	A
Low Line input current	Vin = minimum		8.77	8.86	A
Inrush Transient	Vin = 48V.		TBD	TBD	A <sup>2</sup> -Sec.
Short Circuit input current			0.05	0.1	A
No Load input current	Iout = minimum, unit=ON		50	100	mA
Shut-Down input current(Off, UV, OT)			TBD	TBD	mA
Back Ripple Current			TBD	TBD	mAp-p

GENERAL and SAFETY					
Efficiency	Vin=48V, full load (V2)	93	94.8		%
Isolation Voltage	Input to output			2250	Vdc
	Input to Baseplate			1500	Vdc
	Output to Baseplate			1500	Vdc
Insulation Safety Rating			functional		
Isolation Resistance			10		MΩ
Isolation Capacitance			1000		pF
Safety	Certified to UL-60950-1, CSA-C22.2 No.60950-1, IEC/EN60950-1, 2nd edition (pending)		Yes		
Calculated MTBF	Per Telcordia SR-332, Issue 2, Method 1, Class 1, Ground Fixed, Tcase=+25°C		1800		Hours x 10 <sup>3</sup>

DYNAMIC CHARACTERISTICS					
Switching Frequency (Configurable via PMBus)					
Fixed Frequency Control			150		KHz
Variable Frequency Control (Default)			NA		KHz
Turn On Time (Default, Configurable via PMBus)					
Vin On to Vout Regulated				45	mS
Remote On to Vout Regulated				25	mS
Vout Rise Time (Default, Configurable via PMBus)					
From 0%~100%			20		mS
Vout Fall Time of Regulated Off (Default, Configurable via PMBus)					
From 100%~0%			13		mS
Dynamic Load Response	50-75-50%, 1A/us, within 1% of Vout		TBD	TBD	μSec
Dynamic Load Peak Deviation	same as above		TBD	TBD	mV



### DBQ0260V2 FUNCTIONAL SPECIFICATIONS (CONT.)

FEATURES and OPTIONS	Conditions ①	Minimum	Typical/Nominal	Maximum	Units
<b>Remote On/Off Control</b>					
<b>Primary On/Off control (designed to be driving with an open collector logic, Voltages referenced to -Vin)</b>					
"P" suffix:					
Positive Logic, ON state	ON = pin open or external voltage	3.5		13.5	V
Positive Logic, OFF state	OFF = ground pin or external voltage	0		0.8	V
Control Current	open collector/drain		0.1	0.2	mA
"N" suffix:					
Negative Logic, ON state	ON = ground pin or external voltage	-0.1		0.8	V
Negative Logic, OFF state	OFF = pin open or external voltage	3.5		13.5	V
Control Current	open collector/drain		0.1	0.2	mA
<b>OUTPUT</b>					
Total Output Power		0	300	303	W
<b>Voltage</b>					
Setting Accuracy	At 100% load, no trim, all conditions	4.95	5	5.05	Vdc
Output Adjust Range	Configurable via PMBus	3		5.5	Vdc
Overvoltage Protection	Configurable via PMBus		6		Vdc
Voltage Droop	Default, configurable via PMBus		0		mΩ
<b>Current</b>					
Output Current Range		0	60	60	A
Minimum Load			No minimum load		
Current Limit Inception ②	98% of Vnom., after warmup, Configurable via PMBus			70	A
<b>Short Circuit</b>					
Short Circuit Current	Hiccup technique, autorecovery within 1% of Vout		0.4	1	A
Short Circuit Duration (remove short for recovery)	Output shorted to ground, no damage		Continuous		
Short circuit protection method, default response, configurable via PMBus	Hiccup current limiting		Non-latching		
<b>Regulation ③</b>					
Line Regulation (V2)	Vin = 36-75, Vout = nom., full load			30	mV
Load Regulation (V2)	Iout = min. to max., Vin = nom.			25	mV
Ripple and Noise	5 Hz- 20 MHz BW, Cout = 1μF paralleled with 10μF		50	150	mV pk-pk
Temperature Coefficient	At all outputs		0.01	0.02	% of Vnom./°C
Maximum Output Capacitance	Low ESR			10,000	μF
<b>Power Good—Negative logic (Configurable via PMBus)</b>					
Power good high stage voltage		2.4		3.6	Vdc
Power good low stage voltage		0		0.4	Vdc
Out voltage for power good off triggering	Configurable via PMBus	3	3.5	4	Vdc
Out Voltage for power good on triggering	Configurable via PMBus	3.75	4.25	4.75	Vdc

### DBQ0260V2 FUNCTIONAL SPECIFICATIONS (CONT.)

PMBus	Conditions ①	Minimum	Typical/Nominal	Maximum	Units
<b>PMBus GENERAL</b>					
PMBus REV. 1.2. SMBALERT# is supported. PEC is supported. Linear data format used.					
Bus speed				400	kHz
Logic high input		2		3.3	Vdc
Logic low input		0		0.8	Vdc
Logic high output		2.4			Vdc
Logic low output				0.4	Vdc
<b>PMBus ADDRESSING</b>					
If the calculated PMBus address is 0d, 11d or 12d, SA0 or SA1 lefts open, default PMBus address 119d is assigned instead. PMBus address = 8x(SA0 value) + (SA1 value). SA0, SA1 value VS resistor connected to GND.					
0			10		kΩ
1			22		kΩ
2			33		kΩ
3			47		kΩ
4			68		kΩ
5			100		kΩ
6			150		kΩ
7			220		kΩ
<b>PMBus MONITORING ACCURACY</b>					
VIN_READ		-2		2	%
VOUT_READ		-1		1	%
IOUT_READ (> = 10A)		-5		5	%
IOUT_READ (<10A)		-1		1	A
TEMP_READ		5		5	°C
<b>DIGITAL INTERFACE SPECIFICATIONS (PMBUS MONITORING &amp; FUNCTIONAL DESCRIPTION)</b>					
<b>Fault Protection Specifications</b>					
Output Voltage, Over Voltage protection, OVP	Factory default		6		V
VOUT_OV_FAULT_LIMIT, Configurable via PMBus	>VOUT_OV_WARM_LIMIT	3		6	V
	Restart delay (default, Configurable via PMBus)		500		μS
Input Voltage, Input Over Voltage Protection	Factory default		NA		V
	Setpoint accuracy				%
VIN_OV_FAULT_LIMIT (Configurable via PMBus) ④	>VIN_OV_WARM_LIMIT		NA		V
	Restart delay (default, Configurable via PMBus)				μS
Input Voltage, Input Under Voltage Protection, UVLO	Factory default		32		V
	Setpoint accuracy	-2		2	%
VIN_UV_FAULT_LIMIT (Configurable via PMBus) ④	<VIN_UV_WARM_LIMIT <VIN_OV_FAULT_LIMIT		32	75	V
	Restart delay (default, Configurable via PMBus)		100		μS
Over Current Protection, OCP	Setpoint accuracy (Io)	-2.5		2.5	%
	(factory default)		70		A
IOUT_OC_FAULT_LIMIT (Configurable via PMBus) ④	>IOUT_OC_WARN_LIMT	0		75	A
	Restart delay (default, Configurable via PMBus)		100		μS
Over Temperature Protection, OTP	OT_FAULT_LIMIT (factory default)		120		°C
OT_FAULT_LIMIT (Configurable via PMBus) ④	>OT_WARM_LIMIT	0	30	150	°C
	OTP accuracy (factory default)	5		5	°C
	Restart delay (default, Configurable via PMBus)		500		μS

### DBQ0260V2 FUNCTIONAL SPECIFICATIONS (CONT.)

MECHANICAL	Conditions ①	Minimum	Typical/Nominal	Maximum	Units
Outline Dimensions (open frame)			2.3 x 1.45 x 0.48		Inches
(Please refer to outline drawing)	L x W x H		58.4 x 36.83 x 12.19		mm
Outline Dimensions (with baseplate)			2.3 x 1.45 x 0.50		Inches
			58.4 x 36.80 x 12.7		mm
Weight (open frame)			TBD		Ounces
					Grams
Weight (with baseplate)			TBD		Ounces
					Grams
Through Hole Pin Diameter			0.04 & 0.062		Inches
			1.016 & 1.575		mm
Digital Interface Pin Diameter			0.02		
			0.5		
Through Hole Pin Material			Copper alloy		
TH Pin Plating Metal and Thickness	Nickel subplate		98.4-299		μ-inches
	Gold overplate		4.7-19.6		μ-inches
<b>ENVIRONMENTAL</b>					
Operating Ambient Temperature Range	with derating	-40		85	°C
Operating Baseplate Temperature		-40		110	°C
Storage Temperature	Vin = Zero (no power)	-55		125	°C
Thermal Protection/Shutdown (with "B" Suffix, default value, Configurable via PMBUS)	Configurable Via PMBus		120		°C
Electromagnetic Interference	External filter required; see emissions performance test.		B		Class
Conducted, EN55022/CISPR22					
RoHS rating			RoHS-6		

### Notes

- ① Typical at TA = +25°C under nominal line voltage and full-load conditions. All models are specified with external 1μF and 10μF capacitors in parallel across their output pins. All values are default, unless otherwise noted.
- ② Over-current protection is non-latching with auto recovery (hiccup).
- ③ Regulation specifications describe the output voltage changes as the line voltage or load current is varied from its nominal or midpoint value to either extreme.
- ④ See Operating information section.

### DBQ0135V2: 12V/35A FUNCTIONAL SPECIFICATIONS (VOLTAGE APPLIED TO SCL SDA SMBALERT AND ON/OFF 2, MIN: -0.3V MAX: 3.6V)

ABSOLUTE MAXIMUM RATINGS	Conditions ①	Minimum	Typical/Nominal	Maximum	Units
Input Voltage, Continuous		0		80	Vdc
Input Voltage, Transient	100 mS max. duration			100	Vdc
Isolation Voltage	Input to output			2250	Vdc
On/Off Remote Control	Power on, referred to -Vin	0		13.5	Vdc
Output Power		0		428.4	W
Output Current	Current-limited, no damage, short-circuit protected	0		35	A
SCL / SDA / SMBALERT / ON/OFF 2		-0.3		3.6	Vdc
Storage Temperature Range	Vin = Zero (no power)	-55		125	°C

Absolute maximums are stress ratings. Exposure of devices to greater than any of these conditions may adversely affect long-term reliability. Proper operation under conditions other than those listed in the Performance/Functional Specifications Table is not implied or recommended.

#### INPUT

Operating voltage range (V2)		36	48	75	Vdc
Start-up threshold	(Default, configurable via PMBus)	33	34	35	Vdc
Undervoltage shutdown	(Default, configurable via PMBus)	31	32	34	Vdc
Internal Filter Type			Pi		
External Input fuse			20		A
Input current					
Full Load Conditions	Vin = nominal		9.19	9.44	A
Low Line input current	Vin = minimum		12.25	12.59	A
Inrush Transient	Vin = 48V.		1.3	2.6	A <sup>2</sup> -Sec.
Short Circuit input current			0.05	0.1	A
No Load input current	Iout = minimum, unit=ON		75	112	mA
Shut-Down input current(Off, UV, OT)			20	30	mA
Back Ripple Current			20	40	mAp-p

#### GENERAL and SAFETY

Isolation Voltage	Input to output			2250	Vdc
	Input to Baseplate			1500	Vdc
	Output to Baseplate			1500	Vdc
Insulation Safety Rating			functional		
Isolation Resistance			10		MΩ
Isolation Capacitance			1500		pF
Safety	Certified to UL-60950-1, CSA-C22.2 No.60950-1, IEC/EN60950-1, 2nd edition (pending)		Yes		
Calculated MTBF	Per Telcordia SR-332, Issue 2, Method 1, Class 1, Ground Fixed, Tcase=+25°C		1800		Hours x 10 <sup>3</sup>

#### DYNAMIC CHARACTERISTICS

Switching Frequency (Configurable via PMBus)					
Fixed Frequency Control			175		KHz
Turn On Time (Default, Configurable via PMBus)					
Vin On to Vout Regulated				60	mS
Remote On to Vout Regulated				25	mS
Vout Rise Time (Default, Configurable via PMBus)					
From 0%~100%			20		mS
Vout Fall Time of Regulated Off (Default, Configurable via PMBus)					
From 100%~0%			20		mS
Dynamic Load Response	50-75-50%, 0.1A/us, within 1% of Vout		200	300	μSec
Dynamic Load Peak Deviation	same as above		±300	±500	mV

### DBQ0135V2 FUNCTIONAL SPECIFICATIONS (CONT.)

FEATURES and OPTIONS	Conditions ①	Minimum	Typical/Nominal	Maximum	Units
<b>Remote On/Off Control</b>					
Primary On/Off control (designed to be driving with an open collector logic, Voltages referenced to -Vin)					
"P" suffix:					
Positive Logic, ON state	ON = pin open or external voltage	3.5		13.5	V
Positive Logic, OFF state	OFF = ground pin or external voltage	0		0.8	V
Control Current	open collector/drain		0.1	0.2	mA
"N" suffix:					
Negative Logic, ON state	ON = ground pin or external voltage	-0.1		0.8	V
Negative Logic, OFF state	OFF = pin open or external voltage	3.5		13.5	V
Control Current	open collector/drain		0.1	0.2	mA
Secondary On/Off control (Pull up to 3.3V internally; ignored by default configuration; see technical notes section) Voltages referenced to -Vout					
"P" suffix:					
Positive Logic, ON state	ON = pin open or external voltage	1.5		3.3	V
Positive Logic, OFF state	OFF = ground pin or external voltage	0		0.8	V
Control Current	open collector/drain		0.03	0.06	mA
"N" suffix:					
Negative Logic, ON state	ON = ground pin or external voltage	0		0.8	V
Negative Logic, OFF state	OFF = pin open or external voltage	1.5		3.3	V
Control Current	open collector/drain		0.03	0.06	mA
Remote Sense Compliance	Sense pins connected externally to respective Vout pins				
<b>OUTPUT</b>					
Total Output Power		0	420	428.4	W
<b>Voltage</b>					
Initial Output Voltage (Default, Configurable via PMBus)	@VIN = 48V Iout = 0A temp = 25C, both with/without "S" suffix	11.990		12.030	Vdc
Output Voltage (Default, Configurable via PMBus)	@All condns, without "S" suffix, VOUT_DROOP = 0Ω	11.760	12.000	12.240	Vdc
Output Voltage (Default, Configurable via PMBus)	@All condns, with "S" suffix, VOUT_DROOP = 10mΩ	(12.000- Iout*0.01)*0.98	12.000-Iout*0.01	(12.000- Iout*0.01)*1.02	Vdc
Over-Voltage Protection (Default, Configurable via PMBus)	Direct feedback Fault response is configurable via PMBus	13.80	14.40	15.60	Vdc
<b>Voltage Droop</b>					
Without "S" suffix	Default, Configurable via PMBus		0		mΩ
With "S" suffix			10		mΩ
<b>Current</b>					
Output Current Range		0		35	A
Minimum Load			No minimum load		
Current Limit Inception ②	90% of Vnom., after warmup, Configurable via PMBus		42		A
<b>Short Circuit</b>					
Short Circuit Current	Hiccup technique, autorecovery within 1% of Vout		0.4	1	A
Short Circuit Duration (remove short for recovery)	Output shorted to ground, no damage		Continuous		
Short circuit protection method, default response, configurable via PMBus	Hiccup current limiting		Non-latching		
<b>Regulation ③</b>					
Line Regulation (V2)	Vin = 36-75, Vout = nom., full load Vin=nom.			75	mV
Load Regulation (V2)	Without S suffix: Vout@min_load-Vout@max_load With S suffix: Vout@min_load-Vout@max_load-Iout*VOUT_DROOP			45	mV
Ripple and Noise	5 Hz- 20 MHz BW, Cout = 1μF paralleled with 10μF		100	150	mV pk-pk
Temperature Coefficient	At all outputs		0.01	0.02	% of Vnom./°C
Maximum Output Capacitance	Low ESR			10,000	μF
<b>Power Good—Negative logic (Configurable via PMBus)</b>					
Power good high stage voltage		2.4		3.6	Vdc
Power good low stage voltage		0		0.4	Vdc
Out voltage for power good off triggering	Configurable via PMBus	8.64	9.6	10.56	Vdc
Out Voltage for power good on triggering	Configurable via PMBus	9.72	10.8	11.88	Vdc

### DBQ0135V2 FUNCTIONAL SPECIFICATIONS (CONT.)

PMBus	Conditions ①	Minimum	Typical/Nominal	Maximum	Units
<b>PMBus GENERAL</b>					
PMBus REV. 1.2. SMBALERT# is supported. PEC is supported. Linear data format used.					
Bus speed				400	kHz
Logic high input		2		3.3	Vdc
Logic low input		0		0.8	Vdc
Logic high output		2.4		3.6	Vdc
Logic low output		-0.1		0.4	Vdc
<b>PMBus ADDRESSING</b>					
If the calculated PMBus address is 0d, 11d or 12d, SA0 or SA1 lefts open, default PMBus address 119d is assigned instead. PMBus address = 8x(SA0 value) + (SA1 value). SA0, SA1 value VS resistor connected to GND.					
0			10		kΩ
1			22		kΩ
2			33		kΩ
3			47		kΩ
4			68		kΩ
5			100		kΩ
6			150		kΩ
7			220		kΩ
<b>PMBus MONITORING ACCURACY</b>					
VIN_READ		-2.5		2.5	%
VOUT_READ		-1		1	%
IOUT_READ		-1		1	A
TEMP_READ		-5		5	°C
<b>DIGITAL INTERFACE SPECIFICATIONS (PMBUS MONITORING &amp; FUNCTIONAL DESCRIPTION)</b>					
<b>Fault Protection Specifications</b>					
Output Voltage, Over Voltage protection, OVP	Factory default		14.4		V
VOUT_OV_FAULT_LIMIT, Configurable via PMBus	>VOUT_OV_WARN_LIMIT	8.1		15.6	V
	Restart delay (default, Configurable via PMBus)		500		mS
VIN_OV_FAULT_LIMIT (Configurable via PMBus) ④	>VIN_OV_WARN_LIMIT		34	110	V
	Restart delay (default, Configurable via PMBus)		200		mS
Input Voltage, Input Under Voltage Protection, UVLO	Factory default		32		V
	Setpoint accuracy	-2		2	%
VIN_UV_FAULT_LIMIT (Configurable via PMBus) ④	<VIN_UV_WARN_LIMIT <VIN_OV_FAULT_LIMIT		32	75	V
	Restart delay (default, Configurable via PMBus)		200		mS
Over Current Protection, OCP	Setpoint accuracy (Io)	-3		3	%
	(factory default)		42		A
IOUT_OC_FAULT_LIMIT (Configurable via PMBus) ④	>IOUT_OC_WARN_LIMT	0		50	A
	Restart delay (default, Configurable via PMBus)		500		mS
Over Temperature Protection, OTP	OT_FAULT_LIMIT (factory default)		120		°C
OT_FAULT_LIMIT (Configurable via PMBus) ④	>OT_WARN_LIMIT	0	30	150	°C
	OTP accuracy (factory default)	5		5	°C
	Restart delay (default, Configurable via PMBus)		500		mS

### DBQ0135V2 FUNCTIONAL SPECIFICATIONS (CONT.)

MECHANICAL	Conditions ①	Minimum	Typical/Nominal	Maximum	Units
Outline Dimensions (open frame)			2.3 x 1.45 x 0.48		Inches
(Please refer to outline drawing)	L x W x H		58.4 x 36.83 x 12.19		mm
Outline Dimensions (with baseplate)			2.3 x 1.45 x 0.52		Inches
			58.4 x 36.80 x 13.21		mm
Weight (open frame)			1.85		Ounces
			52.5		Grams
Weight (with baseplate)			2.35		Ounces
			66.8		Grams
Through Hole Pin Diameter			0.04 & 0.062		Inches
			1.016 & 1.575		mm
Digital Interface Pin Diameter			0.020		
			0.5		
Through Hole Pin Material			Copper alloy		
TH Pin Plating Metal and Thickness	Nickel subplate		98.4-299		μ-inches
	Gold overplate		4.7-19.6		μ-inches
ENVIRONMENTAL					
Operating Ambient Temperature Range	with derating	-40		85	°C
Operating Baseplate Temperature		-40		110	°C
Storage Temperature	Vin = Zero (no power)	-55		125	°C
Thermal Protection/Shutdown (with "B" Suffix, default value, Configurable via PMBus)	Configurable Via PMBus		125		°C
Electromagnetic Interference Conducted, EN55022/CISPR22	External filter required; see emissions performance test.		B		Class
RoHS rating			RoHS-6		

### Notes

- ① Typical at TA = +25°C under nominal line voltage and full-load conditions. All models are specified with external 1μF and 10μF capacitors in parallel across their output pins. All values are default, unless otherwise noted.
- ② Over-current protection is non-latching with auto recovery (hiccup).

- ③ Regulation specifications describe the output voltage changes as the line voltage or load current is varied from its nominal or midpoint value to either extreme.
- ④ See Operating information section.

**PERFORMANCE DATA**

Efficiency vs. Line Voltage and Load Current @ +25°C

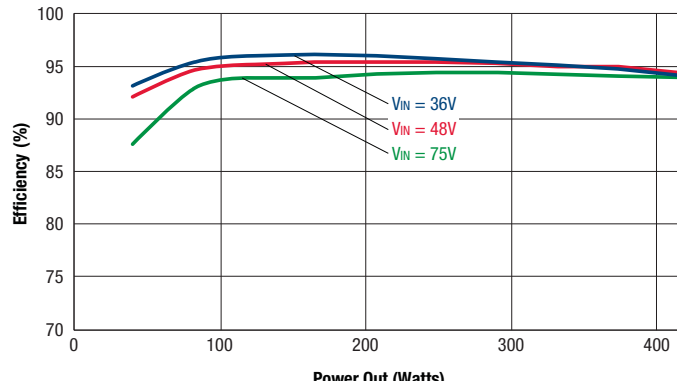

Thermal image at 35A current with 48V input voltage, 30°C ambient temperature, and 100LFM air flow. Identifiable and recommended maximum value to be verified in application.

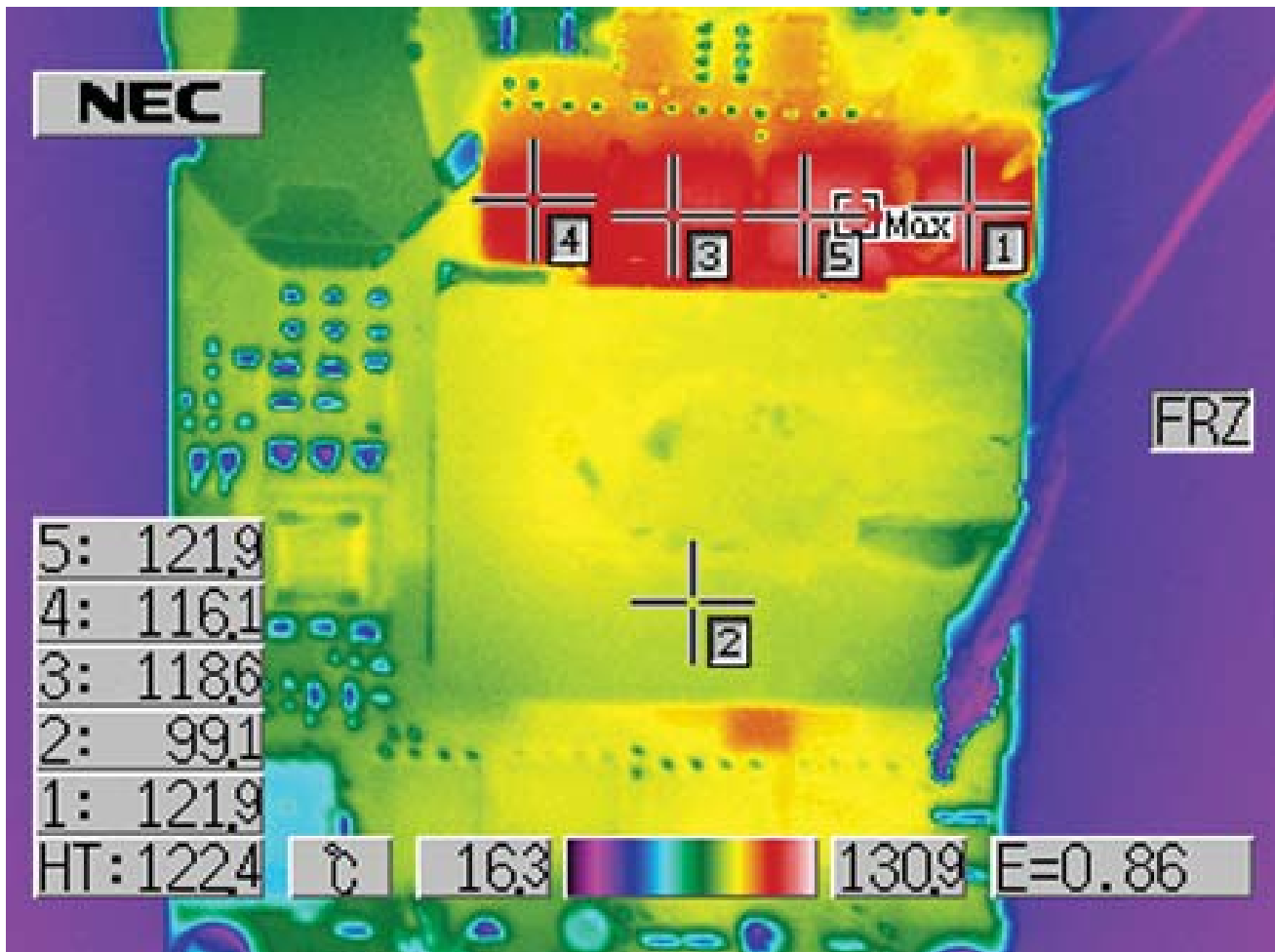



**PERFORMANCE DATA: TEMPERATURE DERATING**

**Open Frame**

**With Baseplate**

Maximum Current Temperature Derating at sea level  
(Vin = 36V, airflow from Vin to Vout)

Maximum Current Temperature Derating at sea level  
(Vin = 36V, airflow from Vin to Vout)

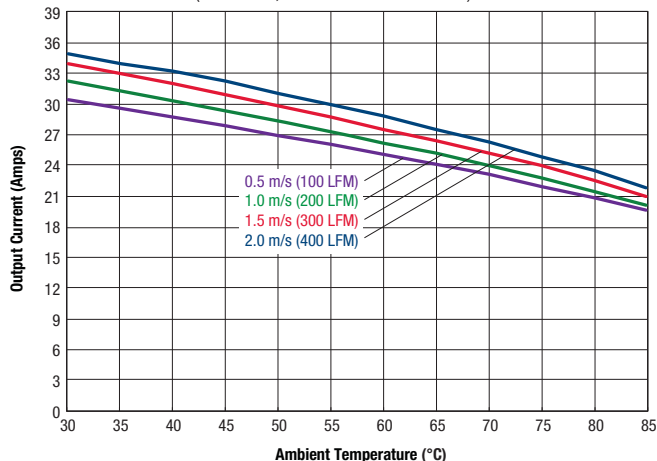

Maximum Current Temperature Derating at sea level  
(Vin = 48V, airflow from Vin to Vout)

Maximum Current Temperature Derating at sea level  
(Vin = 48V, airflow from Vin to Vout)

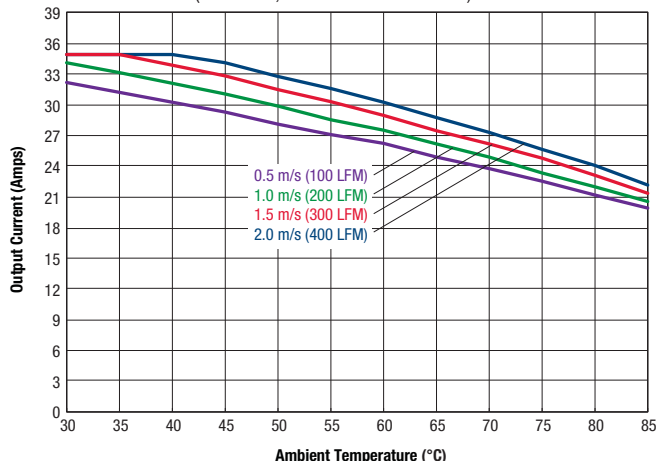
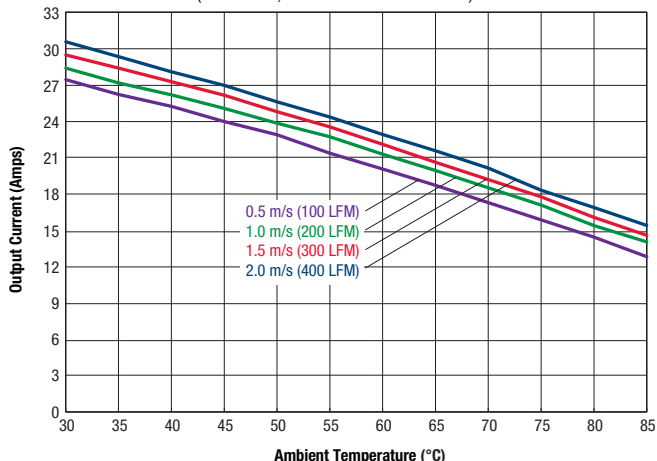

Maximum Current Temperature Derating at sea level  
(Vin = 75V, airflow from Vin to Vout)

Maximum Current Temperature Derating at sea level  
(Vin = 75V, airflow from Vin to Vout)

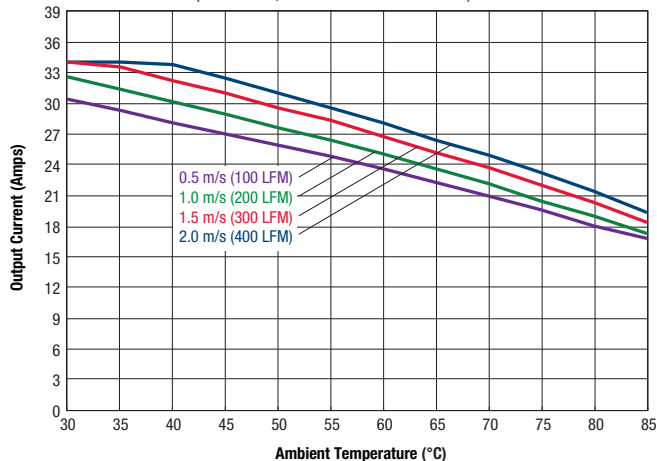
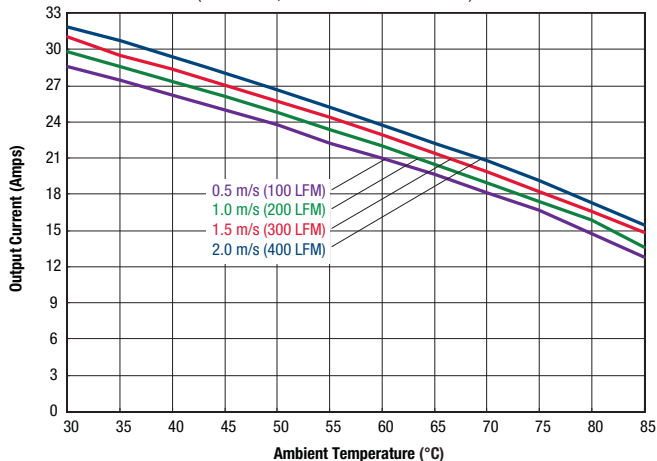

**PERFORMANCE DATA**

Enable Startup Delay (Vin = 48V, Iout = 35A, Cout = 1000uF, Ta = +25°C)  
Ch2 = Vout Ch4 = Enable



Startup Delay (Vin = 48V, Iout = 35A, Cout = 1000uF, Ta = +25°C)  
Ch1 = Vin, Ch2 = Vout



Stepload Transient Response (Vin = 48V, Iout = 50-75-50% of Iout, Load = 1uF || 10uF, slew rate: 0.1A/us, Ta = +25°C)



Output Ripple & Noise (Vin = 48V, Iout = 0A, Cout = 1uF || 10uF, Ta = +25°C)



Output Ripple & Noise (Vin = 48V, Iout = 35A, Cout = 1uF || 10uF, Ta = +25°C)



**MECHANICAL SPECIFICATIONS**

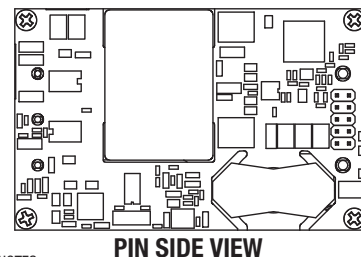
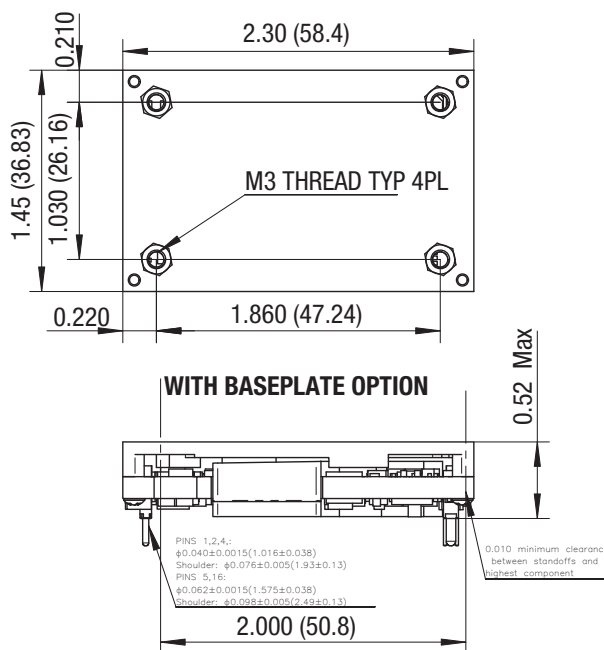
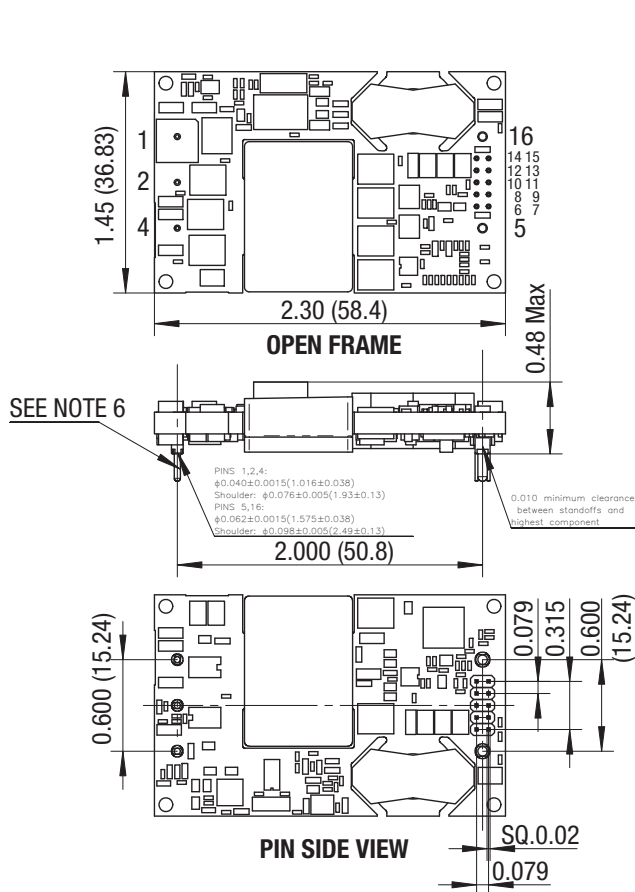

- NOTES:  
 UNLESS OTHERWISE SPECIFIED;  
 1: M3 SCREW USED TO BOLT UNIT'S BASEPLATE TO OTHER SURFACES (SUCH AS HEATSINK) MUST NOT EXCEED 0.100" (2.54mm) DEPTH BELOW THE SURFACE OF BASEPLATE  
 2: APPLIED TORQUE PER SCREW SHOULD NOT EXCEED 5.3in-lb (0.6Nm);  
 3: ALL DIMENSIONS ARE IN INCHES (MILLIMETER);  
 4: ALL TOLERANCES: x.xx in, ±0.02 in (x.xx mm, ±0.5 mm)  
 x.xx in, ±0.01 in (x.xx mm, ±0.25 mm)  
 5: COMPONENT WILL VARY BETWEEN MODELS  
 6: STANDARD PIN LENGTH: 0.180 Inch  
 FOR L1 PIN LENGTH OPTION IN MODEL NAME, THE L LENGTH SHOULD BE 0.110 INCH  
 FOR L2 PIN LENGTH OPTION IN MODEL NAME, USE STANDARD L2 PIN WITH PIN LENGTH TO 0.145 Inch

Dimensions are in inches (mm shown for ref. only).

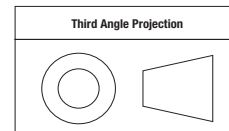

Tolerances (unless otherwise specified):  
 .XX ± 0.02 (0.5)  
 .XXX ± 0.010 (0.25)  
 Angles ± 2°

Components are shown for reference only and may vary between units.

INPUT/OUTPUT CONNECTIONS		
Pin	Designation	Function
1	+VIN	Positive Input
2	On/Off 1 Control	Primary On/Off Control
3	No Pin	No Pin
4	-VIN	Negative Input
5	-VOUT	Negative Output
6	+S	Positive Remote Sense
7	-S	Negative Remote Sense
8	SA0	Address Pin 0
9	SA1	Address Pin 1
10	SCL	PMBus Clock
11	SDA	PMBus Data
12	PG	Power Good Output
13	DGND	PMBus Ground
14	SMBALERT	PMBus Alert Signal
15	On/Off 2 Control	Secondary On/Off Control
16	+VOUT	Positive Output

**STANDARD PACKAGING**



Carton accommodates two (2) trays yielding 30 converters per carton

Dimensions are in inches (mm) shown for ref. only.



Tolerances (unless otherwise specified):  
 .XX ± 0.02 (0.5)  
 .XXX ± 0.010 (0.25)  
 Angles ± 2'

## TECHNICAL NOTES

**Power Management Overview**

The module includes a wide range of readable and configurable power management features that are easy to implement with a minimum of external components. Furthermore, the module includes protection features that continuously protect the load from damage due to unexpected system faults. The SMBALERT pin alerts the host if there is a fault in the module. The following product parameters can continuously be monitored by a host: Vout, Iout, Vin, Temperature, and Power Good. The module is distributed with a default configuration suitable for a wide range operation in terms of Vin, Vout, and load. All power management functions can be reconfigured using the PMBus interface. The product provides a PMBus digital interface that enables the user to configure many aspects of the device operation as well as monitor the input and output parameters. Please contact our FAE for special configurations.

**Soft-start Power Up**

The default rise time of the ramp up is 20 ms. When starting by applying input voltage the control circuit boot-up time adds an additional 10 ms delay. The soft-start power up of the module can be reconfigured using the PMBus interface.

**Over Voltage Protection (OVP)**

The module includes over voltage limiting circuitry for protection of the load. The default OVP limit is 20% above the nominal output voltage. If the output voltage surpasses the OVP limit, the module can respond in different ways. The default response from an over voltage fault is to immediately shut down. The device will continuously check for the presence of the fault condition, and when the fault condition no longer exists the device will be re-enabled. The OVP fault level and fault response can be reconfigured using the PMBus interface.

**Over Current Protection (OCP, Current limit)**

The module includes current limiting circuitry for protection at continuous over load. The default setting for the product is hicup mode. The current limit could be configured by simply setting the IOOUT\_OC\_FAULT\_LIMIT to be greater than the IOOUT\_OC\_WARN\_LIMIT. The maximum value that the current limit could be set is 50A.

**Power Good**

The module provides Power Good (PG) flag in the Status Word register that indicates the output voltage is within a specified tolerance of its target level and no fault condition exists. The Power Good pin default logic is negative and it can be configured by MFR\_PGOOD\_POLARITY.

**PMBus Interface**

This module offers a PMBus digital interface that enables the user to configure many characteristics of the device operation as well as to monitor the input and output voltages, output current and device temperature. The module can be used with any standard two-wire I2C or SMBus host device. In addition, the module is compatible with PMBus version 1.2 and includes an SMBALERT line to help alleviate bandwidth limitations related to continuous fault monitoring. The module supports 100 kHz and 400 kHz bus clock frequency only.

**Monitoring via PMBus**

A system controller (host device) can monitor a wide variety of parameters through the PMBus interface. The controller can monitor fault conditions by monitoring the SMBALERT pin, which will be asserted when any number of pre-configured fault or warning conditions occur. The system controller can also continuously monitor any number of power conversion parameters including but not limited to the following:

- Input voltage
- Output voltage
- Output current
- Module temperature

**Software Tools for Design and Production**

For these modules, Murata-PS provides software for configuring and monitoring via the PMBus interface. For more information please contact your local Murata-PS representative.

[Click here for Application Note AN-63, Digital DC-DC Evaluation Board User Guide.](#)

[Click here for Application Note AN-64, Murata Power Brick GUI User Manual.](#)

**PMBus Addressing**

Figure 1 and the accompanying table display the recommended resistor values for hard-wiring PMBus addresses (1% tolerance resistors recommended): The address is set in the form of two octal (0 to 7) digits, with each pin setting one digit. The resistor values for each digit is shown below.

The SA0 and SA1 pins can be configured with a resistor to GND according to the following equation.

$$\text{PMBus Address} = 8 \times (\text{SA0value}) + (\text{SA1 value})$$

C0 and C1 are 4.7nF capacitors, which are recommended for correct addressing. If the calculated PMBus address is 0d, 11d or 12d, PMBus address 119d is assigned instead. From a system point of view, the user shall also be aware of further limitations of the addresses as stated in the PMBus Specification. It is not recommended to keep the SA0 and SA1 pins left open.

**PMBus Commands**

The products are designed to be PMBus compliant. The following tables list the implemented PMBus read commands. For more detailed information see “PMBus Power System Management Protocol Specification, Part I – General Requirements, Transport and Electrical Interface” and “PMBus Power System Management Protocol, Part II – Command Language.”



Figure 1. Schematic of Connection of Address Resistors

Digit (SA0, SA1 index)	Resistor Value [kΩ]
0	10
1	22
2	33
3	47
4	68
5	100
6	150
7	220

**OVERALL**

CMD	Command Name <sup>1</sup>	SMBus Transaction Type: Writing Data	SMBus Transaction Type: Reading Data	Number Of Data Bytes
01h	OPERATION <sup>2</sup>	Write Byte	Read Byte	1
02h	ON_OFF_CONFIG <sup>3</sup>	Write Byte	Read Byte	1
03h	CLEAR_FAULTS	Send byte	N/A	0
10h	WRITE_PROTECT	Write Byte	Read Byte	1
11h	STORE_DEFAULT_ALL <sup>4</sup>	Send byte	N/A	0
12h	RESTORE_DEFAULT_ALL <sup>4</sup>	Send byte	N/A	0
15h	STORE_USER_ALL <sup>4</sup>	Send byte	N/A	0
16h	RESTORE_USER_ALL <sup>4</sup>	Send byte	N/A	0
19h	CAPABILITY	N/A	Read Byte	1
20h	VOUT_MODE	N/A	Read Byte	1
21h	VOUT_COMMAND	Write Word	Read Word	2
22h	VOUT_TRIM	Write Word	Read Word	2
25h	VOUT_MARGIN_HIGH	Write Word	Read Word	2
26h	VOUT_MARGIN_LOW	Write Word	Read Word	2
28h	VOUT_DROOP	Write Word <sup>16</sup>	Read Word	2
40h	VOUT_OV_FAULT_LIMIT	Write Word	Read Word	2
41h	VOUT_OV_FAULT_RESPONSE <sup>5</sup>	Write Byte	Read Byte	1
42h	VOUT_OV_WARN_LIMIT	Write Word	Read Word	2
46h	IOUT_OC_FAULT_LIMIT	Write Word	Read Word	2
47h	IOUT_OC_FAULT_RESPONSE <sup>6</sup>	Write Byte	Read Byte	1
4Ah	IOUT_OC_WARN_LIMIT	Write Word	Read Word	2
4Fh	OT_FAULT_LIMIT	Write Word	Read Word	2
50h	OT_FAULT_RESPONSE <sup>5</sup>	Write Byte	Read Byte	1
51h	OT_WARN_LIMIT	Write Word	Read Word	2
55h	VIN_OV_FAULT_LIMIT	Write Word	Read Word	2
56h	VIN_OV_FAULT_RESPONSE <sup>7</sup>	Write Byte	Read Byte	1
57h	VIN_OV_WARN_LIMIT	Write Word	Read Word	2
58h	VIN_UV_WARN_LIMIT	Write Word	Read Word	2
59h	VIN_UV_FAULT_LIMIT	Write Word	Read Word	2
5Ah	VIN_UV_FAULT_RESPONSE <sup>7</sup>	Write Byte	Read Byte	1
5Eh	POWER_GOOD_ON	Write Word	Read Word	2
5Fh	POWER_GOOD_OFF	Write Word	Read Word	2

### OVERALL (CONT.)

CMD	Command Name <sup>1</sup>	SMBus Transaction Type: Writing Data	SMBus Transaction Type: Reading Data	Number Of Data Bytes
60h	TON_DELAY	Write Word <sup>16</sup>	Read Word	2
61h	TON_RISE <sup>14</sup>	Write Word <sup>16</sup>	Read Word	2
64h	TOFF_DELAY	Write Word <sup>16</sup>	Read Word	2
65h	TOFF_FALL <sup>14</sup>	Write Word <sup>16</sup>	Read Word	2
78h	STATUS_BYTE	Write Byte	Read Byte	1
79h	STATUS_WORD	Write Word	Read Word	2
7Ah	STATUS_VOUT	Write Byte	Read Byte	1
7Bh	STATUS_IOUT	Write Byte	Read Byte	1
7Ch	STATUS_INPUT	Write Byte	Read Byte	1
7Dh	STATUS_TEMPERATURE	Write Byte	Read Byte	1
7Eh	STATUS_CML	Write Byte	Read Byte	1
88h	READ_VIN	N/A	Read Word	2
8Bh	READ_VOUT	N/A	Read Word	2
8Ch	READ_IOUT	N/A	Read Word	2
8Dh	READ_TEMPERATURE_1 <sup>8</sup>	N/A	Read Word	2
94h	READ_DUTY_CYCLE	N/A	Read Word	2
95h	READ_FREQUENCY	N/A	Read Word	2
96h	READ_POUT	N/A	Read Word	2
98h	PMBus_REVISION	N/A	Read Byte	1
99h	MFR_ID	N/A	Block Read	22
9Ah	MFR_MODEL <sup>9</sup>	N/A	Block Read	<=20
9Bh	MFR_REVISION <sup>9</sup>	N/A	Block Read	<=10
9Dh	MFR_DATE <sup>9</sup>	N/A	Block Read	<=10
9Eh	MFR_SERIAL <sup>9</sup>	N/A	Block Read	<=10
A0h	MFR_VIN_MIN	N/A	Read Word	2
A1h	MFR_VIN_MAX	N/A	Read Word	2
A2h	MFR_IIN_MAX	N/A	Read Word	2
A3h	MFR_PIN_MAX	N/A	Read Word	2
A4h	MFR_VOUT_MIN	N/A	Read Word	2
A5h	MFR_VOUT_MAX	N/A	Read Word	2
A6h	MFR_IOUT_MAX	N/A	Read Word	2
A7h	MFR_POUT_MAX	N/A	Read Word	2
A8h	MFR_TAMBIENT_MAX	N/A	Read Word	2
A9h	MFR_TAMBIENT_MIN	N/A	Read Word	2
B0h	USER_DATA_00	Block Write	Block Read	<=20
B1h	USER_DATA_01	Block Write	Block Read	<=20
C0h	MFR_MAX_TEMP_1	N/A	Read Word	2
DBh	MFR_CURRENT_SHARE_CONFIG	N/A	Read Byte	1
DDh	MFR_PRIMARY_ON_OFF_CONFIG	Write Byte	Read Byte	1
DEh	MFR_PGOOD_POLARITY	Write Byte	Read Byte	1
E8h	MFR_VIN_OV_FAULT_HYS	Write Word	Read Word	2
E9h	MFR_VIN_UV_FAULT_HYS	Write Word	Read Word	2
EAh	MFR_OT_FAULT_HYS	Write Word	Read Word	2

### OVERALL (CONT.)

#### Notes:

1. a) Unit restores the entire contents of the non-volatile User Store memory when power up  
 b) PEC is supported  
 c) Max bus speed: 400kHz  
 d) SMBALERT# is supported  
 e) Linear data format used  
 f) addressing: If the calculated PMBus address is 0d, 11d or 12d, SA0 or SA1 lefts open, default PMBus address 119d is assigned instead.
2. Not supported items:  
 100101XXb Margin Low(Ignore Fault),  
 101001XXb On Margin High(Ignore Fault)
3. Restart delay of turned off by OPEATION or CONTROL or primary on/off is 200ms
4. Unit will shutdown 1 second for protection , then recover automatically.
5. Restart delay unit: 500ms, lower limit: 500ms.  
 Turn off delay unit: 0ms, lower limit: 0ms  
 if bits 7:6=11b, restart delay is 500ms
6. Restart delay unit and Turn off delay unit are same as note 5  
 Bits 7:6: 00b,01b,10b are not supported
7. Restart delay unit: 200ms, lower limit: 200ms.  
 Turn off delay unit:0ms, lower limit: 0ms  
 if bits 7:6=11b, restart delay is 200ms
8. Temperature of baseplate side
9. Unit's actual information
10. Default value of DROOP CURRENT SHARE ENABLED mode: 0x01  
 Default value of DROOP CURRENT SHARE DISABLED mode: 0x00
11. Locked to 10mΩ in DROOP CURRENT SHARE mode; configurable and default value is 0mΩ in CURRENT SHARE DISABLED mode
12. Default value of negative logic: 0x04  
 Default value of positive logic: 0x06
13. Unit can receive any value for VOUT\_TRIM command, but Vout is limited to 8.1~13.2V, if calculated Vout exceeds limit, then equal to limit.
14. Value of 0 is acceptable, which is the same as lower limit to unit.
15. Default value of without "B" suffix: 120°C  
 Default value of with "B" suffix: 125°C
16. Configurable while without "S" suffix locked while with "S" suffix

### MURATA-PS DEFINED COMMANDS (01-CFH REFER TO PMBUS 1.2 SPEC)

DBh: MFR_CURRENT_SHARE_CONFIG				On/Off 2 pin	VOUT_DROOP	TON_DELAY	TOFF_DELAY	TON_RISE	TOFF_FALL
Bits	Purpose	Value	Meaning						
7:1		0000000	Reserved	--	--	--	--	--	--
0	Droop Current Share Control	0	Current share disabled	On/Off 2	configurable	configurable	configurable	configurable	configurable
		1	Droop current share mode enabled	On/Off 2	locked to 0x000A	locked to 0x0001	locked to 0x0000	locked to 0x0000	locked to 0x0000
DDh: MFR_PRIMARY_ON_OFF_CONFIG									
Bits	Purpose	Value	Meaning						
7:3		00000	Reserved						
2	Controls how the unit responds to the CONTROL pin	0	Unit ignores the primary ON/OFF pin						
		1	Unit requires the primary ON/OFF pin to be asserted to start the unit.						
1	Polarity of primary ON/OFF logic	0	Active low (Pull pin low to start the unit)						
		1	Active high (Pull high or open to start the unit)						
0		0	Reserved						
DEh: MFR_PGOOD_POLARITY									
Bits	Purpose	Value	Meaning						
7:1		0000000	Reserved						
0	Power good polarity of pin 12	0	Negative logic, output low if Vout rises to specific value						
		1	Positive logic, output high if Vout rises to specific value						



**STATUS WORD AND BYTE (GREEN = SUPPORTED)**

STATUS_VOUT	
7	VOUT_OV_FAULT
6	VOUT_OV_WARNING
5	VOUT_UV_WARNING
4	VOUT_UV_FAULT
3	VOUT_MAX Warning
2	TON_MAX_FAULT
1	TOFF_MAX_WARNING
0	VOUT Tracking Error

STATUS_IOUT	
7	IOUT_OC_FAULT
6	IOUT_OC_LV_FAULT
5	IOUT_OC_WARNING
4	IOUT_UC_FAULT
3	Current Share Fault
2	In Power Limiting Mode
1	POUT_OP_FAULT
0	POUT_OP_WARNING

STATUS_TEMPERATURE	
7	OT_FAULT
6	OT_WARNING
5	UT_WARNING
4	UT_FAULT
3	Reserved
2	Reserved
1	Reserved
0	Reserved

STATUS_CML	
7	Invalid/Unsupported Command
6	Invalid/Unsupported Data
5	Packet Error Check Failed
4	Memory Fault Detected
3	Processor Fault Detected
2	Reserved
1	Other Communication Fault
0	Other Memory Or Logic Fault

STATUS_WORD	
7	VOUT
6	IOUT/POUT
5	INPUT
4	MFR_SPECIFIC
3	POWER_GOOD#
2	FANS
1	OTHER
0	UNKNOWN
7	BUSY
6	OFF
5	VOUT_OV_FAULT
4	IOUT_OC_FAULT
3	VIN_UV_FAULT
2	TEMPERATURE
1	CML
0	NONE OF THE ABOVE

STATUS_OTHER	
7	Reserved
6	Reserved
5	Input A Fuse/Breaker Fault
4	Input B Fuse/Breaker Fault
3	Input A OR-ing Device Fault
2	Input B OR-ing Device Fault
1	Output OR-ing Device Fault
0	Reserved

STATUS_INPUT	
7	VIN_OV_FAULT
6	VIN_OV_WARNING
5	VIN_UV_WARNING
4	VIN_UV_FAULT
2	IIN_OC_FAULT
1	IIN_OC_WARNING
0	PIN_OP_WARNING

STATUS_MFR_SPECIFIC	
Manufacturer Defined	
Manufacturer Defined	
Manufacturer Defined	
Manufacturer Defined	
Manufacturer Defined	
Manufacturer Defined	
Manufacturer Defined	
Manufacturer Defined	

STATUS_FANS_1_2	
7	Fan 1 Fault
6	Fan 2 Fault
5	Fan 1 Warning
4	Fan 2 Warning
3	Fan 1 Speed Override
2	Fan 2 Speed Override
1	Air Flow Fault
0	Air Flow Warning

STATUS_FANS_3_4	
7	Fan 3 Fault
6	Fan 4 Fault
5	Fan 3 Warning
4	Fan 4 Warning
3	Fan 3 Speed Override
2	Fan 4 Speed Override
1	Reserved
0	Reserved

### TECHNICAL NOTES (CONT.)

#### Parallel Load Sharing (S Option, Droop Load Sharing)

Two or more converters may be connected in parallel at both the input and output terminals to support higher output current (total power, see figure 2) or to improve reliability due to the reduced stress that results when the modules are operating below their rated limits. For applications requiring current share, followed the guidelines below. The products have a pre-configured voltage droop. The stated output voltage set point is at no load. The output voltage will decrease when the load current is increased. The voltage will drop 0.35V while load reaches max load. Our goal is to have each converter contribute nearly identical current into the output load under all input, environmental and load conditions.

#### Using Parallel Connections – Load Sharing (Power Boost)

Direct Connection Parallel Guidelines

- Use a common input power source. The input voltage must be between 36V and 75V.
- +Vout and –Vout of all parallel units should be connected with a balance output impedance; +Sense and –Sense should be connected together (see figure 2).
- Turn all units off before configuring the output voltage via PMBus commands; all units must have the same output voltage configuration.
- It is recommended to turn on one unit first and then turn other unit (s) on after the output for the first one has settled. Turn on the next unit (s) after the previous unit reaches its regulated output voltage for at least 10mS. Users can use a different control signal to turn each unit on.
- Users have the option to use a common primary or secondary Remote On/Off logic control signal to turn on modules at the same time after the input voltage rises above 36V.
- If using PMBus to control units ON/OFF in parallel operation, we suggest to control one unit on first. After the output voltage is stable, then make other units' output on.
- First power up the parallel system (all converters) with a load not exceeding the rated load of 60%\*35A\*UNITS\_QUANTITY and allow converters to settle (typically 20mS) before applying full load (90% load is recommended).
- When converters are connected in parallel, allow for a safety factor of at least 10%. Up to 90% of max output current can be used from each module.
- It is critical that the PCB layout incorporates identical connections from each module to the load; use the same trace rating and airflow/thermal environments. If you add output filter components, use identical components and layout.
- For Power-down, do not soft-off (GUI) while in parallel operation. Power down units by primary or secondary On/Off signal. Turn units off at the same time or one by one to avoid the OCP being triggered.

**CAUTION:** This converter is not internally fused. To avoid danger to persons or equipment and to retain safety certification, the user must connect an external fast-blow input fuse as listed in the specifications. Be sure that the PCB pad area and etch size are adequate to provide enough current so that the fuse will blow with an overload.

#### Using Parallel Connections – Redundancy (N+1)

The redundancy connections require external user supplied “OR”ing diodes or “OR”ing MOSFETs for reliability purposes. The diodes allow for an uninterrupted power system operation in case of a catastrophic failure (shorted output) by one of the converters.

The diodes should be identical part numbers to enhance balance between the converters. The default factory nominal voltage should be sufficiently matched between converters. The OR’ing diode system is the responsibility of the user. Be aware of the power levels applied to the diodes and possible heat sink requirements.

Schottky power diodes with approximately 0.3V drops or “OR”ing MOSFETs may be suitable in the loop whereas 0.7 V silicon power diodes may not be advisable. In the event of an internal device fault or failure of the mains power modules on the primary side, the other devices automatically take over the entire supply of the loads. In the basic N+1 power system, the “N” equals the number of modules required to fully power the system and “+1” equals one back-up module that will take over for a failed module. If the system consists of two power modules, each providing 50% of the total load power under normal operation and one module fails, another one delivers full power to the load. This means you can use smaller and less expensive power converters as the redundant elements, while achieving the goal of increased availability.

#### Thermal Shutdown

Extended operation at excessive temperature will initiate overtemperature shutdown triggered by a temperature sensor outside the PWM controller. This operates similarly to overcurrent and short circuit mode. The inception point of the overtemperature condition depends on the average power delivered, the ambient temperature and the extent of forced cooling airflow. Thermal shutdown uses only the hiccup mode (autorestart) and PMBus configurable hysteresis.

#### Start Up Considerations

When power is first applied to the DC-DC converter, there is some risk of start up difficulties if you do not have both low AC and DC impedance and adequate regulation of the input source. Make sure that your source supply does not allow the instantaneous input voltage to go below the minimum voltage at all times.

Use a moderate size capacitor very close to the input terminals. You may need two or more parallel capacitors. A larger electrolytic or ceramic cap supplies the surge current and a smaller parallel low-ESR ceramic cap gives low AC impedance.

Remember that the input current is carried both by the wiring and the ground plane return. Make sure the ground plane uses adequate thickness copper. Run additional bus wire if necessary.

#### Input Fusing

Certain applications and/or safety agencies may require fuses at the inputs of power conversion components. Fuses should also be used when there is the possibility of sustained input voltage reversal which is not current-limited. For greatest safety, we recommend a fast blow fuse installed in the ungrounded input supply line.

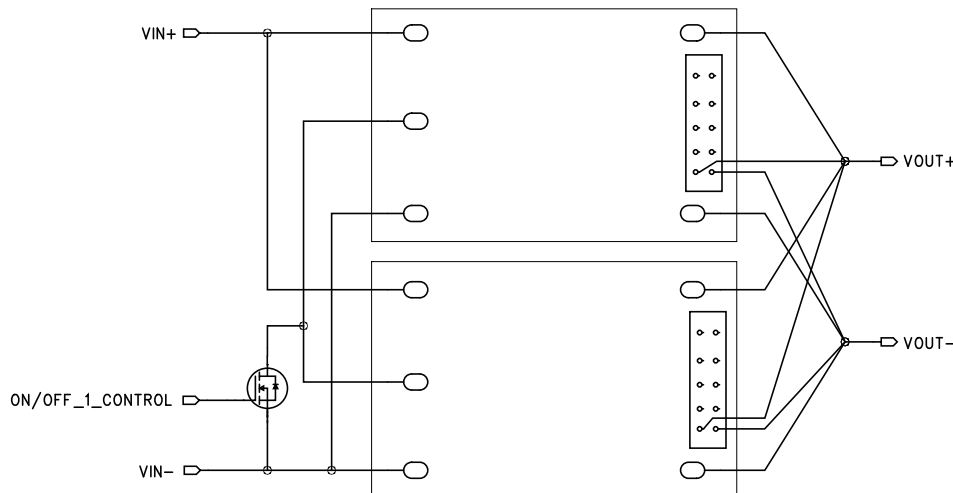

Figure 2. Load Sharing Block Diagram

**Input Under-Voltage Shutdown and Start-Up Threshold**

Converters will not begin to regulate properly until the rising input voltage exceeds and remains at the Start-Up Threshold Voltage (see Specifications). Once operating, converters will not turn off until the input voltage drops below the Under-Voltage Shutdown Limit. Subsequent restart will not occur until the input voltage rises again above the Start-Up Threshold. This built-in hysteresis prevents any unstable on/off operation at a single input voltage. The over/under-voltage fault level and fault response and hysteresis can be configured via the PMBus interface.

**Start-Up Time**

Start-Up Time (see Specifications) is the time interval between the point when the rising input voltage crosses the Start-Up Threshold and the output voltage enters and remains within its specified accuracy band.

These converters include a soft start circuit to control Vout ramp time, thereby limiting the input inrush current.

The On/Off Remote Control interval from On command to Vout (final  $\pm 5\%$ ) assumes that the converter already has its input voltage stabilized above the Start-Up Threshold before the On command. The interval is measured from the On command until the output enters and remains within its specified accuracy band.

**Recommended Input Filtering**

The user must assure that the input source has low AC impedance to provide dynamic stability and that the input supply has little or no inductive content, including long distributed wiring to a remote power supply. The converter will operate with no additional external capacitance if these conditions are met.

For best performance, we recommend installing a low-ESR capacitor immediately adjacent to the converter’s input terminals. The capacitor should be a ceramic type such as the Murata GRM32 series or a polymer type. More input bulk capacitance may be added in parallel (either electrolytic or tantalum) if needed.

**Recommended Output Filtering**

The converter will achieve its rated output ripple and noise with no additional external capacitor. However, the user may install more external output capacitance to reduce the ripple even further or for improved dynamic response. Again, use low-ESR ceramic (Murata GRM32 series) or polymer capacitors. Mount these close to the converter. Measure the output ripple under your load conditions.

Use only as much capacitance as required to achieve your ripple and noise objectives. Excessive capacitance can make step load recovery sluggish or possibly introduce instability. Do not exceed the maximum rated output capacitance listed in the specifications.

**Input Ripple Current and Output Noise**

All models in this converter series are tested and specified for input reflected ripple current and output noise using designated external input/output components, circuits and layout as shown in the figures below. The Cbus and Lbus components simulate a typical DC voltage bus.

**Minimum Output Loading Requirements**

All models regulate within specification and are stable under no load to full load conditions.



Figure 3. Measuring Input Ripple Current

$C_{IN} = 220\mu\text{F}$ , ESR < 700m $\Omega$  @ 100kHz  
 $C_{BUS} = 220\mu\text{F}$ , ESR < 100m $\Omega$  @ 100kHz  
 $L_{BUS} = 12\mu\text{H}$



Figure 4. Measuring Output Ripple and Noise (PARD)

$C1 = 1\mu\text{F}$ ;  $C2 = 10\mu\text{F}$

LOAD 2-3 INCHES (51-76mm) FROM MODULE

**Thermal Shutdown (OTP, UTP)**

To prevent many over temperature problems and damage, these converters include thermal shutdown circuitry. If environmental conditions cause the temperature of the DC-DCs to rise above the Operating Temperature Range up to the shutdown temperature, an on-board electronic temperature sensor will power down the unit. When the temperature decreases below the turn-on threshold set in the command recover temp is (OT\_FAULT\_LIMIT-MFR\_OT\_FAULT\_HYS), the hysteresis is defined in general electrical specification section. The OTP and hysteresis of the module can be reconfigured using the PMBus. The OTP and UTP fault limit and fault response can be configured via the PMBus.

**CAUTION:** If you operate too close to the thermal limits, the converter may shut down suddenly without warning. Be sure to thoroughly test your application to avoid unplanned thermal shutdown.

**Temperature Derating Curves**

The graphs in this data sheet illustrate typical operation under a variety of conditions. The Derating curves show the maximum continuous ambient air temperature and decreasing maximum output current which is acceptable under increasing forced airflow measured in Linear Feet per Minute (“LFM”). Note that these are AVERAGE measurements. The converter will accept brief increases in current or reduced airflow as long as the average is not exceeded.

Note that the temperatures are of the ambient airflow, not the converter itself which is obviously running at higher temperature than the outside air. Also note that “natural convection” is defined as very low rates which are not using fan-forced airflow. Depending on the application, “natural convection” is usually about 30-65 LFM but is not equal to still air (0 LFM).

Murata Power Solutions makes Characterization measurements in a closed cycle wind tunnel with calibrated airflow. We use both thermocouples and an infrared camera system to observe thermal performance. As a practical matter, it is quite difficult to insert an anemometer to precisely measure airflow in most applications. Sometimes it is possible to estimate the effective airflow if you thoroughly understand the enclosure geometry, entry/exit orifice areas and the fan flowrate specifications.

**CAUTION:** If you exceed these Derating guidelines, the converter may have an unplanned Over Temperature shut down. Also, these graphs are all collected near Sea Level altitude. Be sure to reduce the derating for higher altitude.

**Output Short Circuit Condition**

The short circuit condition is an extension of the “Current Limiting” condition. When the monitored peak current signal reaches a certain range, the PWM controller’s outputs are shut off thereby turning the converter “off.” This is followed by an extended time out period. This period can vary depending on other conditions such as the input voltage level. Following this time out period, the PWM controller will attempt to re-start the converter by initiating a “normal start cycle” which includes softstart. If the “fault condition” persists, another “hiccup” cycle is initiated. This “cycle” can and will continue indefinitely until such time as the “fault condition” is removed, at which time the converter will resume “normal operation.” Operating in the “hiccup” mode during a fault condition is advantageous in that average input and output power levels are held low preventing excessive internal increases in temperature.

**Remote On/Off Control**

The DBQ series modules are equipped with both primary (On/Off 1, enabled, pull up internal) and secondary (On/Off 2, disabled, pull up internal) control pins for increased system flexibility. Both are configurable via PMBus. The On/Off pins are TTL open-collector and/or CMOS open-drain compatible. (See general specifications for threshold voltage levels. See also MFR\_PRIMARY\_ON\_OFF\_CONFIG section.)

Negative-logic models are on (enabled) when the On/Off is grounded or brought to within a low voltage (see specifications) with respect to -Vin. The device is off (disabled) when the On/Off is left open or is pulled high to +13.5Vdc with respect to -Vin. The On/Off function allows the module to be turned on/off by an external device switch.

Positive-logic models are enabled when the On/Off pin is left open or is pulled high to +13.5V with respect to -Vin. Positive-logic devices are disabled when the On/Off is grounded or brought to within a low voltage (see specifications) with respect to -Vin. For voltage levels for On/Off 2 signal see functional specifications.

The restart delay for this module to turn On/Off by the On/Off control pin is 200ms.

On/Off 1 or 2 Control status	Not ignored		Ignored	
	P LOGIC	N LOGIC	P LOGIC	N LOGIC
OPEN	ON	OFF	ON	ON
PULL HIGH	ON	OFF	ON	ON
PULL LOW	OFF	ON	ON	ON

On/Off 1 can be configured by PMBus command MFR\_PRIMARY\_ON\_OFF\_CONFIG (DDh); default configuration is not ignored; required On/Off 1 control pin to be asserted to start the unit.

On/Off 2 can be configured by PMBus command ON\_OFF\_CONFIG (02h); default configuration is ignored; treat it as always ON.

DBQ's On/Off status is dependent on On/Off 1 control, On/Off 2 control, and OPERATION (PMBus command) status; all three must be ON to turn DBQ on; if one of them is OFF, unit will be turned off.

### Output Capacitive Load

These converters do not require external capacitance added to achieve rated specifications. Users should only consider adding capacitance to reduce switching noise and/or to handle spike current load steps. Install only enough capacitance to achieve noise objectives. Excess external capacitance may cause degraded transient response and possible oscillation or instability.

### Remote Sense Input

Use the Sense inputs with caution. Sense is normally connected at the load. Sense inputs compensate for output voltage inaccuracy delivered at the load.



Figure 5. Remote Sense Circuit Configuration

This is done by correcting IR voltage drops along the output wiring and the current carrying capacity of PC board etc. This output drop (the difference between Sense and Vout when measured at the converter) should not exceed 0.5V. Consider using heavier wire if this drop is excessive. Sense inputs also improve the stability of the converter and load system by optimizing the control loop phase margin.

Note: The Sense input and power Vout lines are internally connected through low value resistors to their respective polarities so that the converter can operate without external connection to the Sense. Nevertheless, if the Sense function is not used for remote regulation, the user should connect +Sense to +Vout and -Sense to -Vout at the converter pins.

The remote Sense lines carry very little current. They are also capacitively coupled to the output lines and therefore are in the feedback control loop to regulate and stabilize the output. As such, they are not low impedance inputs and must be treated with care in PC board layouts. Sense lines on the PCB should run adjacent to DC signals, preferably Ground. In cables and discrete wiring, use twisted pair, shielded tubing or similar techniques.

Any long, distributed wiring and/or significant inductance introduced into the Sense control loop can adversely affect overall system stability. If in doubt, test your applications by observing the converter's output transient response during step loads. There should not be any appreciable ringing or oscillation. You may also adjust the output trim slightly to compensate for voltage loss in any external filter elements. Do not exceed maximum power ratings.

Please observe Sense inputs tolerance to avoid improper operation:

$$[V_{out(+)} - V_{out(-)}] - [Sense(+)] - Sense(-)] \leq 5\% \text{ of } V_{out}$$

Output overvoltage protection is monitored at the output voltage pin, not the Sense pin. Therefore excessive voltage differences between Vout and Sense together with trim adjustment of the output can cause the overvoltage protection circuit to activate and shut down the output.

Power derating of the converter is based on the combination of maximum output current and the highest output voltage. Therefore the designer must ensure:

$$(V_{out \text{ at pins}}) \times (I_{out}) \leq (\text{Max. rated output power})$$

### Soldering Guidelines

Murata Power Solutions recommends the specifications below when installing these converters. These specifications vary depending on the solder type. Exceeding these specifications may cause damage to the product. Be cautious when there is high atmospheric humidity. We strongly recommend a mild pre-bake (100° C. for 30 minutes). Your production environment may differ; therefore please thoroughly review these guidelines with your process engineers.

Wave Solder Operations for through-hole mounted products (THMT)	
<b>For Sn/Ag/Cu based solders:</b>	
Maximum Preheat Temperature	115° C.
Maximum Pot Temperature	270° C.
Maximum Solder Dwell Time	7 seconds
<b>For Sn/Pb based solders:</b>	
Maximum Preheat Temperature	105° C.
Maximum Pot Temperature	250° C.
Maximum Solder Dwell Time	6 seconds

**Emissions Performance**

Murata Power Solutions measures its products for conducted emissions against the EN 55022 and CISPR 22 standards. Passive resistance loads are employed and the output is set to the maximum voltage. If you set up your own emissions testing, make sure the output load is rated at continuous power while doing the tests.

The recommended external input and output capacitors (if required) are included. Please refer to the fundamental switching frequency. All of this information is listed in the Product Specifications. An external discrete filter is installed and the circuit diagram is shown below.



Figure 6. Conducted Emissions Test Circuit

**[1] Conducted Emissions Parts List**

Reference	Part Number	Description	Vendor
C1, C2, C3, C4, C5	GRM32ER72A105KA01L	SMD CERAMIC-100V-1000nF-X7R-1210	Murata
C6	GRM319R72A104KA01D	SMD CERAMIC100V-100nF-±10%-X7R-1206	Murata
L1, L2	PG0060T	COMMON MODE-473uH-±25%-14A	Pulse
C8, C9, C10, C11	GRM55DR72J224KW01L	SMD CERAMIC630V-0.22uF-±10%-X7R-2220	Murata
C7	UHE2A221MHD	Aluminum100V-220uF-±10%-long lead	Nichicon
C12	NA		

**[2] Conducted Emissions Test Equipment Used**

Hewlett Packard HP8594L Spectrum Analyzer – S/N 3827A00153  
2Line V-networks LS1-15V 50Ω/50uH Line Impedance Stabilization Network

**[3] Conducted Emissions Test Results**



Peak Detection Value

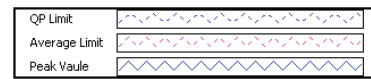

Graph 1. Conducted emissions performance, Positive Line, CISPR 22, Class B, full load



Peak Detection Value

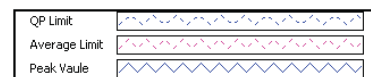

Graph 2. Conducted emissions performance, Negative Line, CISPR 22, Class B, full load

**[4] Layout Recommendations**

Most applications can use the filtering which is already installed inside the converter or with the addition of the recommended external capacitors. For greater emissions suppression, consider additional filter components and/or shielding. Emissions performance will depend on the user's PC board layout, the chassis shielding environment and choice of external components. Please refer to Application Note GEAN-02 for further discussion.

Since many factors affect both the amplitude and spectra of emissions, we recommend using an engineer who is experienced at emissions suppression.

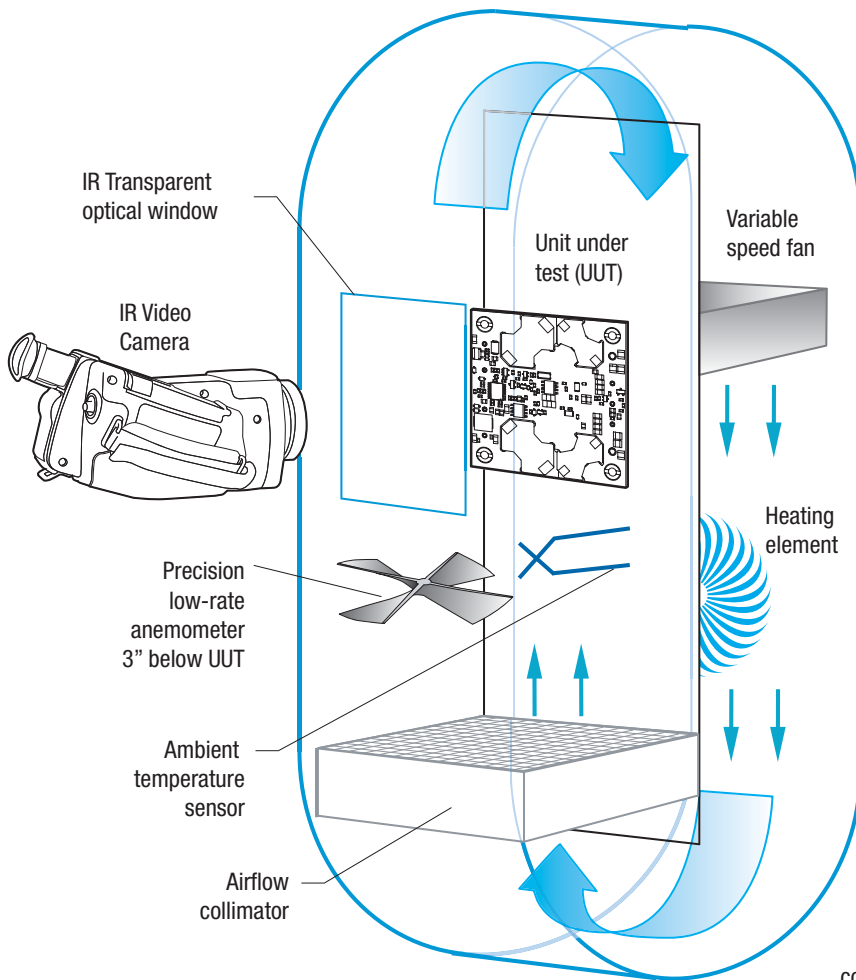

Figure 7. Vertical Wind Tunnel

**Vertical Wind Tunnel**

Murata Power Solutions employs a computer controlled custom-designed closed loop vertical wind tunnel, infrared video camera system, and test instrumentation for accurate airflow and heat dissipation analysis of power products. The system includes a precision low flow-rate anemometer, variable speed fan, power supply input and load controls, temperature gauges, and adjustable heating element.

The IR camera monitors the thermal performance of the Unit Under Test (UUT) under static steady-state conditions. A special optical port is used which is transparent to infrared wavelengths.

Both through-hole and surface mount converters are soldered down to a 10" x 10" host carrier board for realistic heat absorption and spreading. Both longitudinal and transverse airflow studies are possible by rotation of this carrier board since there are often significant differences in the heat dissipation in the two airflow directions. The combination of adjustable airflow, adjustable ambient heat, and adjustable Input/Output currents and voltages mean that a very wide range of measurement conditions can be studied.

The collimator reduces the amount of turbulence adjacent to the UUT by minimizing airflow turbulence. Such turbulence influences the effective heat transfer characteristics and gives false readings. Excess turbulence removes more heat from some surfaces and less heat from others, possibly causing uneven overheating.

Both sides of the UUT are studied since there are different thermal gradients on each side. The adjustable heating element and fan, built-in temperature gauges, and no-contact IR camera mean that power supplies are tested in real-world conditions.



Компания «Океан Электроники» предлагает заключение долгосрочных отношений при поставках импортных электронных компонентов на взаимовыгодных условиях!

Наши преимущества:

- Поставка оригинальных импортных электронных компонентов напрямую с производств Америки, Европы и Азии, а так же с крупнейших складов мира;
- Широкая линейка поставок активных и пассивных импортных электронных компонентов (более 30 млн. наименований);
- Поставка сложных, дефицитных, либо снятых с производства позиций;
- Оперативные сроки поставки под заказ (от 5 рабочих дней);
- Экспресс доставка в любую точку России;
- Помощь Конструкторского Отдела и консультации квалифицированных инженеров;
- Техническая поддержка проекта, помощь в подборе аналогов, поставка прототипов;
- Поставка электронных компонентов под контролем ВП;
- Система менеджмента качества сертифицирована по Международному стандарту ISO 9001;
- При необходимости вся продукция военного и аэрокосмического назначения проходит испытания и сертификацию в лаборатории (по согласованию с заказчиком);
- Поставка специализированных компонентов военного и аэрокосмического уровня качества (Xilinx, Altera, Analog Devices, Intersil, Interpoint, Microsemi, Actel, Aeroflex, Peregrine, VPT, Syfer, Eurofarad, Texas Instruments, MS Kennedy, Miteq, Cobham, E2V, MA-COM, Hittite, Mini-Circuits, General Dynamics и др.);

Компания «Океан Электроники» является официальным дистрибьютором и эксклюзивным представителем в России одного из крупнейших производителей разъемов военного и аэрокосмического назначения «JONHON», а так же официальным дистрибьютором и эксклюзивным представителем в России производителя высокотехнологичных и надежных решений для передачи СВЧ сигналов «FORSTAR».



## JONHON

«JONHON» (основан в 1970 г.)

Разъемы специального, военного и аэрокосмического назначения:

(Применяются в военной, авиационной, аэрокосмической, морской, железнодорожной, горно- и нефтедобывающей отраслях промышленности)

«FORSTAR» (основан в 1998 г.)

ВЧ соединители, коаксиальные кабели,  
кабельные сборки и микроволновые компоненты:

(Применяются в телекоммуникациях гражданского и специального назначения, в средствах связи, РЛС, а так же военной, авиационной и аэрокосмической отраслях промышленности).



Телефон: 8 (812) 309-75-97 (многоканальный)

Факс: 8 (812) 320-03-32

Электронная почта: [ocean@oceanchips.ru](mailto:ocean@oceanchips.ru)

Web: <http://oceanchips.ru/>

Адрес: 198099, г. Санкт-Петербург, ул. Калинина, д. 2, корп. 4, лит. А