

2mm pitch, high reliability with lock, board to cable and cable to cable connector

GT8E Series



Overview

The GT8E series comes with a 2mm pitch lock, for discreet cable, board-to-cable and cable-to-cable connectors. It is highly reliable in terms of vibration, heat and environmental resistance, and is used in applications such as industrial equipment, which are exposed to harsh vibration, in-vehicle equipment requiring high heat resistance, and so on.

Features

1. High reliability

The GT8E series has high reliability in the following 5 aspects, namely vibration resistance, thermal shock resistance and so on, and is usable in industrial and in-vehicle equipment exposed to harsh environments. (It meets the test conditions for various in-vehicle equipment)

- ① Vibration resistance: Contact resistance is stable during the vibration test
With the female terminal featuring an airtight dimple mechanism, the contact point portion area is minimized, and contact pressure is enhanced.
- ② Thermal shock resistance: Usable under harsh temperature environments
Test conditions: (-40°C: 30 minutes → normal temperature: 5 minutes → 105°C: 30 minutes → normal temperature: 5 minutes)
It has undergone 1000 cycles.
- ③ Heat resistance: Usable up to 105°C
PBT and PPS are used in molds, and usable up to 105°C. (including temperature increase at power distribution)
- ④ Half joint prevention
With an audibly clicking lock, and inertia lock via a mechanical lock mechanism, firm connection is ensured. Also, the full lock mechanism means it resists tension and vibration. (Figure 1)
- ⑤ Environment resistance
When mated status, it passed the sulfite gas resistance test (concentration 500ppm, 8 hours).

2. Improved fixation power of the crimp terminal

The waterproof relay type is usable with retainer equipped, and high retention against removal is ensured when the cable is pulled.

3. Decent variation

- Straight DIP type
- Right angle SMT type
- Right angle DIP type
- In-line type (Waterproof)

4. Space saving

The pin header includes both SMT and DIP types. Exclusive reinforcing clasps are used instead of screws ensuring high peel strength and saving space.

5. Reduction of implementation man-hours

In SMT type pin headers, the lead reflow type reinforcing clasps, which are available for reflow soldering, are used. As well as ensuring high peel strength, implementation can be performed via a one-time reflow, thus reducing the man-hours required in comparison to screw type connectors. (Figure 2)

Mechanical lock mechanism



Half mating prevention mechanism

Enlarged form to improve workability, and with an audibly clicking lock, and inertia lock via a mechanical lock mechanism, firm connection is ensured.

Excellent lock strength, vibration resistance

Lock strength is guaranteed up to a standard value of 98N, while it also resists vibration and cable tension. The vibration resistance also cleared the test for harsh vehicles.

Figure 1

Lead reflow

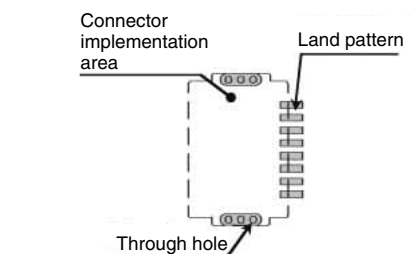

Soldering can be applied to the land pattern and through hole at the same time, reinforcing the clasp and the SMT terminal via a one-time reflow process.

Compared to the conventional reinforcing clasp used in SMT implementation, higher peel strength is ensured.

Figure 2

■ Specifications

Ratings	Current rating	3A	Operating temperature range	-40 to +105°C (Note 1)
	Voltage rating 30 Vrms AC	250V AC	Storage temperature range	-40 to +105°C (Note 1)

Item	Specification	Conditions
1. Insulation resistance	100MΩ min.	500 V DC
2. Withstanding voltage	No flashover or insulation breakdown	650 Vrms AC / 1 minute
3. Contact resistance	30mΩ max	1A DC
4. Durability	Contact resistance 60 mΩ max.	30 cycles
5. Vibration	No electrical discontinuity of 10μs or longer	Frequency: 20 to 200 Hz, single amplitude of 43.1m/s ² , at 3hours for 3 directions
6. Shock	No electrical discontinuity of 10μs or longer	Frequency: 20 to 50 Hz, 66.6m/s ² , at 1 hours
7. Lock strength	During applying, mating completely After applying, no defect of mating parts.	Applying a pull force the mating axially at 98N max.
8. Humidity	Contact resistance 60 mΩ max. Insulation resistance: 100 MΩ min.	96 hours at of 60°, and humidity of 90 to 95%
9. Temperature cycle	Contact resistance 50 mΩ max. Insulation resistance: 500 MΩ min.	-40°C → +5 to 35°C → +85°C → +5 to 35°C Time: 30min. → 5min. → 30min. → 5min. 1000 cycles
10. Resistance to soldering heat	No deformation of affecting performance	

Note 1: Includes temperature rise caused by current flow.

Note 2: Information contained in this catalog represents general requirements for this Series.

Contact us for the drawings and specifications for a specific part number shown.

■ Materials

Product	Part	Material	Finish	Remarks
Header	Insulator	PBT or PPS	Color: Black	UL94V-0
	Contact	Brass	Tin plated or Tin-copper plated	————
	Metal fittings	Brass	Tin plated or Tin-copper plated	————
Socket	Insulator	PBT	Color: Black	————
Crimping Contact for Socket	Contact	Phosphor bronze	Tin plated	————
In-line plug	Insulator	PBT	Color: Black	UL94V-0
Crimping contact for in-line plug	Contact	Brass or Copper alloy	Tin plated	
Retainer	Insulator	PBT	Color: Dark gray	————
Bushing	Insulator	Silicon rubber	Color: White	————

■ Connector Mating Combinations

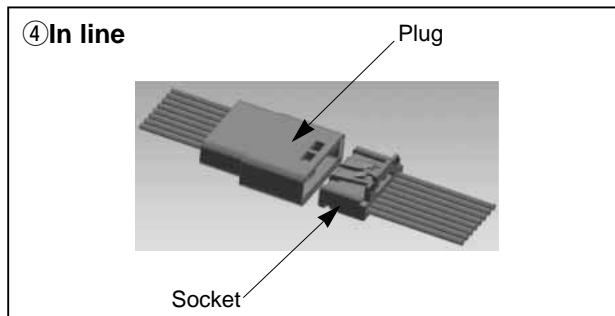
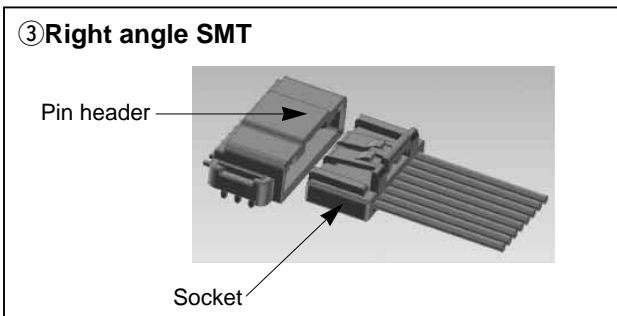
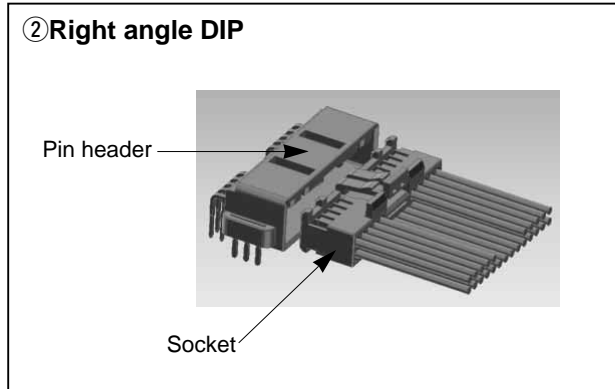
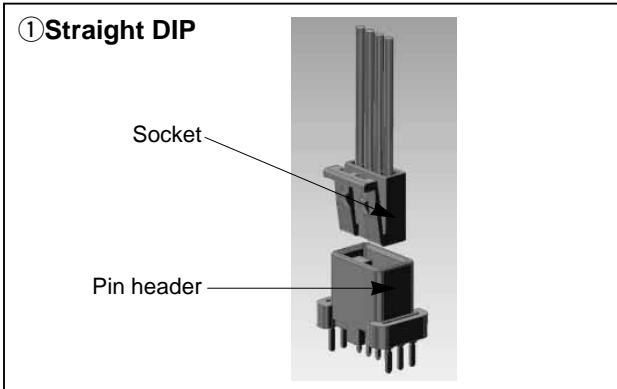

Type	Pin Header	Socket
① Straight DIP	GT8E-*P-DSA	GT8E-*S-HU
② Right angle DIP	GT8E-*P-DS	GT8E-2S-2C
	GT8E-*DP-DS	GT8E-*S-HU
③ Right angle SMT	GT8E-8DP-2H	GT8E-8DS-2C
	GT8E-2P-2H	GT8E-2S-2C
	GT8E-8/2P-2H	GT8E-8S-2C, GT8E-2S-2C
	GT8E-8/5P-2H	GT8E-8S-2C, GT8E-5S-HU
④ In line (Waterproof)	GT8E-8P-HU	GT8E-8S-2C
	GT8EW-4P-HU	GT8EW-4S-HU

■ Straight pin header (DIP)

● Full lock type

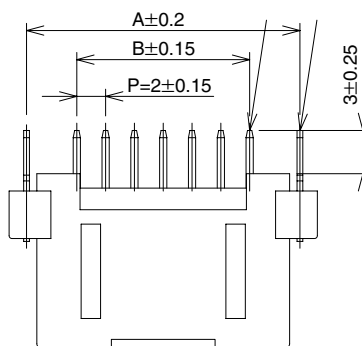

■ Recommended PCB Mounting Pattern

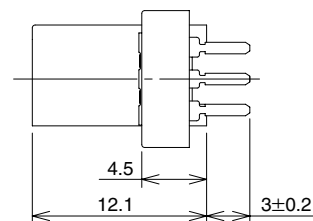
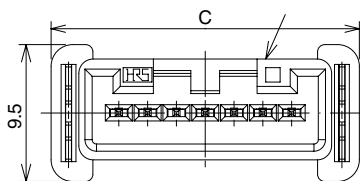
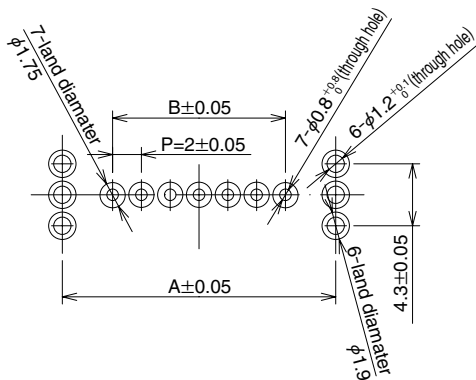

All dimensions: mm

Part Number	CL No.	Number of contacts	A	B	C	Packaging
GT8E-4P-DSA	758-0065-0	4	11.98	6	14.4	1
GT8E-7P-DSA	758-0066-3	7	18.98	12	21.4	

Note : GT8E-*P-DSA mates GT8E-*S-HU.

■Right angle pin header (DIP)

●Full lock type (2 to 10 pos. / Single row)



■Recommended PCB Mounting Pattern

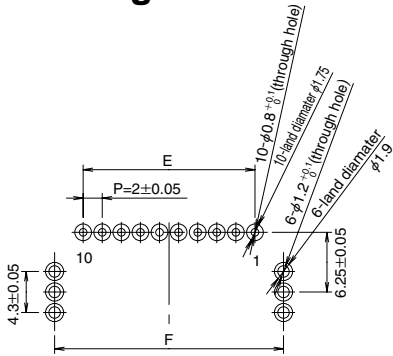

■Fully mated connector assemblies

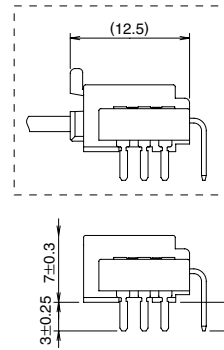

Material	Finish
PBT(Housing)	Color:Black
Brass(Contact)	Tin plated
Brass(Metal fitting)	Tin plated

All dimensions: mm

Part Number	CL No.	Number of contacts	A dimension Tolerance (±0.3)	B dimension Tolerance (±0.3)	C dimension Tolerance (±0.15)	D dimension Tolerance (±0.2)	E dimension Tolerance (±0.05)	F dimension Tolerance (±0.05)	Packaging
GT8E-2P-DS	758-0040-0	2	13	9.15	2	10.58	2	10.58	1
GT8E-3P-DS	758-0057-2	3	13.7	9.85	4	11.28	4	11.28	
GT8E-4P-DS	758-0041-2	4	14.4	10.55	6	11.98	6	11.98	
GT8E-5P-DS	758-0058-5	5	17.8	13.95	8	15.38	8	15.38	
GT8E-6P-DS	758-0042-5	6	18.4	14.55	10	15.98	10	15.98	
GT8E-7P-DS	758-0059-8	7	21.4	17.55	12	18.98	12	18.98	
GT8E-8P-DS	758-0043-8	8	22.4	18.55	14	19.98	14	19.98	
GT8E-10P-DS	758-0044-0	10	26.4	22.55	18	23.98	18	23.98	

Note 1 : Applicable housing is GT8E-*S-HU.

Note 2 : GT8E-2P-DS mates with GT8E-2S-2C.

●Full lock type (12 to 24 pos. / Double row)



■Recommended PCB Mounting Pattern

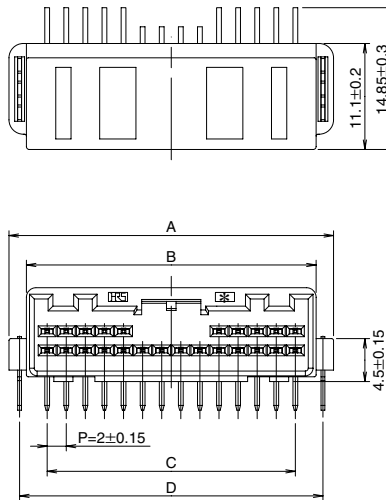
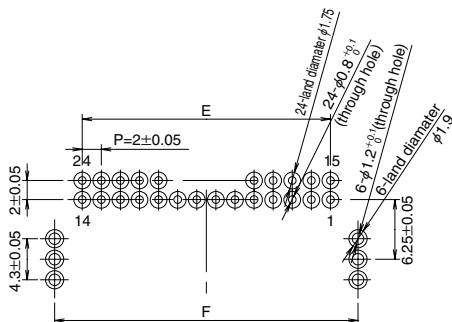

■Fully mated connector assemblies

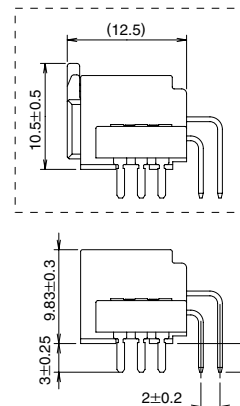

Material	Finish
PBT(Housing)	Color:Black
Brass(Contact)	Tin plated
Brass(Metal fitting)	Tin plated

All dimensions: mm

Part Number	CL No.	Number of contacts	A dimension Tolerance (±0.3)	B dimension Tolerance (±0.3)	C dimension Tolerance (±0.15)	D dimension Tolerance (±0.2)	E dimension Tolerance (±0.05)	F dimension Tolerance (±0.05)	Packaging
GT8E-12DP-DS	758-0045-3	12	22.4	18.55	14	19.98	14	19.98	1
GT8E-16DP-DS	758-0060-7	16	27.25	23.6	18	25.03	18	25.03	
GT8E-20DP-DS	758-0046-6	20	30	26.35	22	27.78	22	27.78	
GT8E-24DP-DS	758-0053-1	24	34	30.35	26	31.78	26	31.78	

Note : Applicable housing is GT8E-*DS-HU.

Right angle pin header (SMT)

Full lock type (8 pos.)



Recommended PCB Mounting Pattern



Fully mated connector assemblies



Part Number	CL No.	Material	Finish	Packaging
GT8E-8DP-2H(70)	758-0028-4-70	PPS(Housing)	Color:Black	400 pcs. per reel
		Brass(Contact)	Tin plated	
		Brass(Reinforced fitting)	Tin plated	

Note : Applicable housing is GT8E-8DS-2C.

Full lock type (2 pos.)



Recommended PCB Mounting Pattern

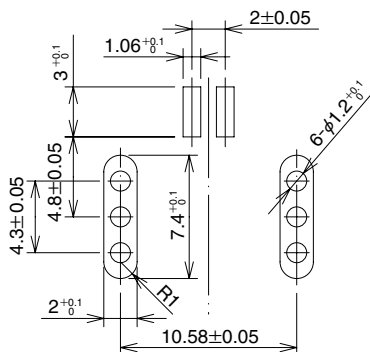

Fully mated connector assemblies



Material	Finish
PPS(Housing)	Color:Black
Brass(Contact)	Tin plated
Brass(Reinforced fitting)	Tin plated

All dimensions: mm

Part Number	CL No.	Number of contacts	A dimension Tolerance (±0.3)	B dimension Tolerance (±0.3)	C dimension Tolerance (±0.15)	D dimension Tolerance (±0.2)	E dimension Tolerance (±0.05)	F dimension Tolerance (±0.05)	Packaging
GT8E-2P-2H(70)	758-0032-1-70	2	13	9.15	2	10.58	2	10.58	400 pcs. per reel
GT8E-3P-2H	758-0096-4	3	13.7	9.85	4	11.28	4	11.28	
GT8E-4P-2H	758-0079-5	4	14.4	10.55	6	11.98	6	11.98	

Note : Applicable housing is GT8E-*S-HU.

●Full lock type (8 / 2 pos.)



■Recommended PCB Mounting Pattern

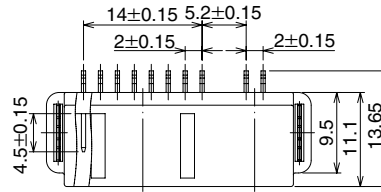
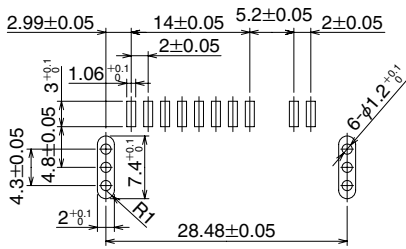

■Fully mated connector assemblies

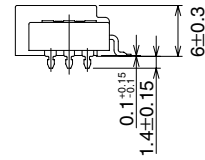
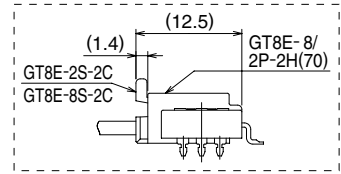

Part Number	CL No.	Material	Finish	Packaging
GT8E-8/2P-2H(70)	758-0031-9-70	PPS(Housing)	Color:Black	500 pcs. per reel
		Brass(Contact)	Tin plated	
		Brass(Reinforced fitting)	Tin plated	

Note : Applicable housing is GT8E-2S-2C, GT8E-8S-2C.

●Full lock type (8 / 5 pos.)

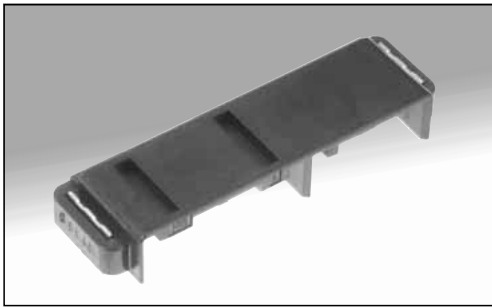

■Recommended PCB Mounting Pattern

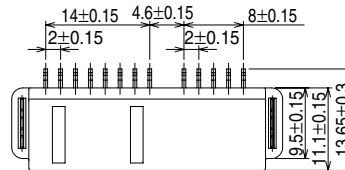
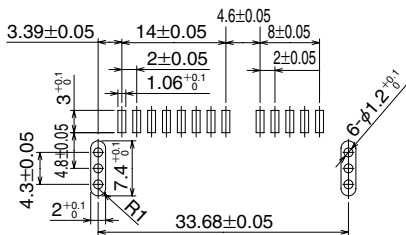

■Fully mated connector assemblies

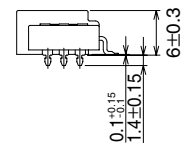
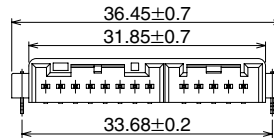
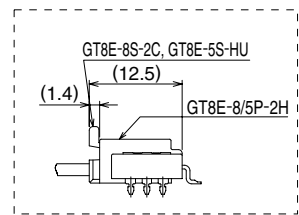

Part Number	CL No.	Material	Finish	Packaging
GT8E-8/5P-2H	758-0073-9	PPS(Housing)	Color:Black	500 pcs. per reel
		Brass(Contact)	Tin plated	
		Brass(Reinforced fitting)	Tin plated	

Note : Applicable housing is GT8E-5S-HU, GT8E-8S-2C.

■Socket

●Full lock type

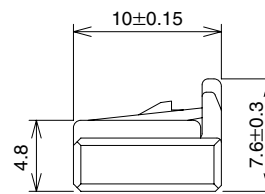
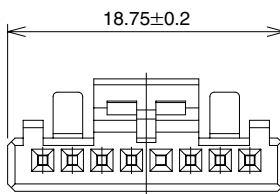
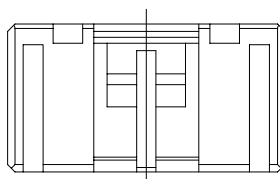
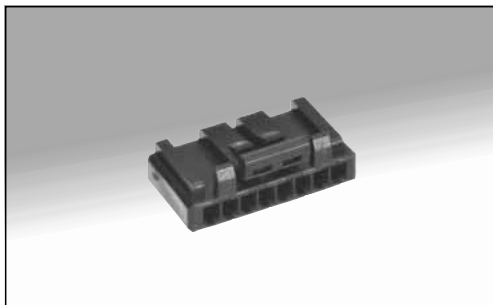

Socket	Applicable	Applicable conductor
GT8E-8DS-2C	AWG #20~22	GT8-2022SCF
	AWG #24~28	GT8-2428SC(F)



Part Number	CL No.	Material	Color	Number of contact	Packaging
GT8E-8DS-2C	758-0027-1	RBT	Black	8	1

Note 1 : Applicable terminal is GT8-2022CF, GT8-2428CF(70).

Note 2 : Applicable housing is GT8E-8DP-2H(70).

●Full lock type

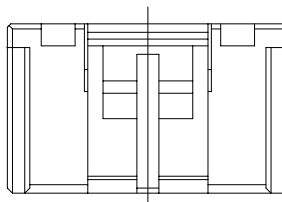
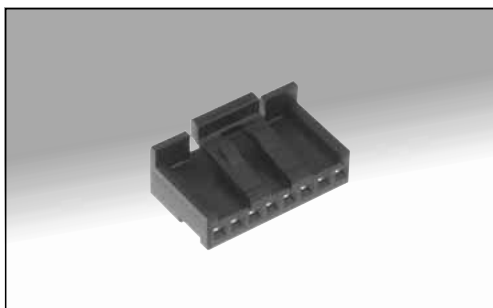

Socket	Applicable	Applicable conductor
GT8E-*S-2C	AWG #20~22	GT8E-2022SCF
	AWG #24~28	GT8B-2428SCF

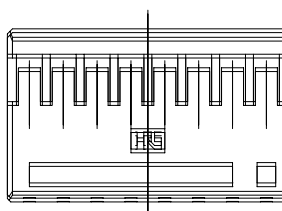

All dimensions: mm

Part Number	CL No.	Material	Color	Number of contact	A	Packaging
GT8E-2S-2C	758-0030-6	RBT	Black	2	7.1	1
GT8E-8S-2C	758-0029-7			8	16.6	

Note 1 : Applicable terminal is GT8E-2022SCF, GT8B-2428SCF.

Note 2 : GT8E-2S-2C mates with GT8E-2P-2H(70), GT8E-8/2P-2H(70) or GT8E2P-DS.

GT8E-2S-2C mates with GT8E-8/2P-2H(70).

● Full lock type (3 to 10 pos. / Single row)

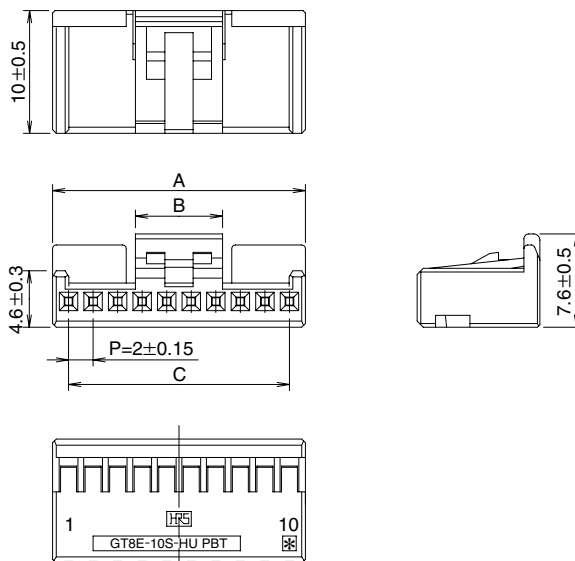
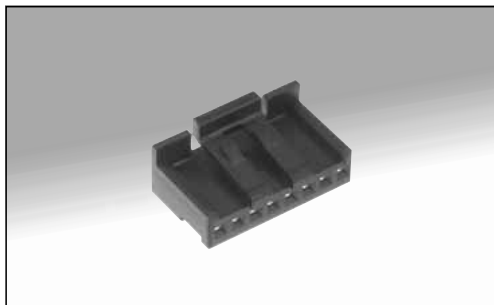

Socket	Applicable	Applicable conductor
GT8E-8S-HU	AWG #20~22	GT8-2022SCF
	AWG #24~28	GT8-2428SC(F)

All dimensions: mm

Part Number	CL No.	Material	Color	Number of contact	A	B	C	Packaging
GT8E-3S-HU	758-0061-0	RBT	Black	3	7.9±0.5	7.9±0.5	4±0.15	1
GT8E-4S-HU	758-0047-9			4	8.6±0.5	8.6±0.5	6±0.15	
GT8E-5S-HU	758-0062-2			5	12±0.5	7.1±0.5	8±0.15	
GT8E-6S-HU	758-0048-1			6	12.6±0.5	7.1±0.5	10±0.15	
GT8E-7S-HU	758-0063-5			7	15.6±0.5	7.1±0.5	12±0.15	
GT8E-8S-HU	758-0049-4			8	16.6±0.5	7.1±0.5	14±0.15	
GT8E-10S-HU	758-0050-3			10	20.6±0.7	7.1±0.5	18±0.15	

Note 1 : Applicable terminal is GT8E-2022SCF, GT8-2428SCF.

Note 2 : Applicable housing is GT8E-*P-DS.

● Full lock type (12 to 24 pos. / Double row)

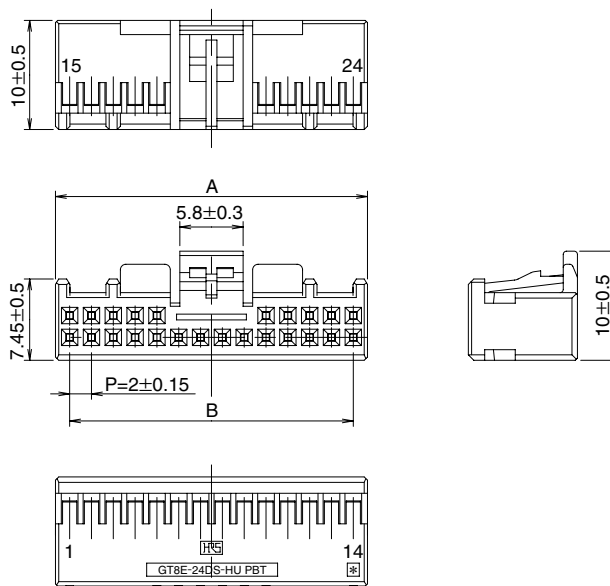
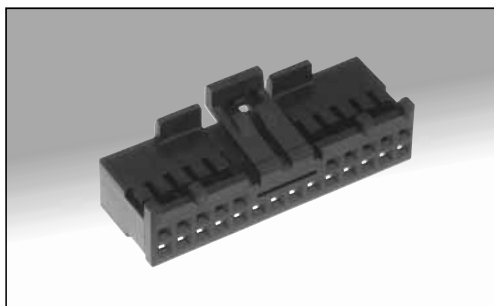

Socket	Applicable	Applicable conductor
GT8E-*DS-HU	AWG #20~22	GT8E-2022SCF
	AWG #24~28	GT8B-2428SCF

All dimensions: mm

Part Number	CL No.	Material	Color	Number of contact	A	B	Packaging
GT8E-12DS-HU	758-0051-6	RBT	Black	12	16.6±0.5	14±0.15	1
GT8E-16DS-HU	758-0064-8			16	21.85±0.7	18±0.15	
GT8E-20DS-HU	758-0052-9			20	24.6±0.7	22±0.15	
GT8E-24DS-HU	758-0054-4			24	28.6±0.7	26±0.15	

Note 1 : Applicable terminal is GT8E-2022SCF, GT8B-2428SCF.

Note 2 : Applicable housing is GT8E-*DP-DS.

■In-line type

●Full lock in-line type

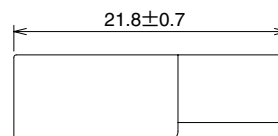

Plug	Applicable	Applicable conductor
GT8E-*P-HU	AWG #20~22	GT8E-2022PCF
	AWG #24~28	GT8E-2428PCF

All dimensions: mm

Part Number	CL No.	Material	Color	Number of contact	A	B dimension Tolerance (±0.15)	Packaging
GT8E-3P-HU	758-0084-5	RBT	Black	3	10.55±0.5	4	1
GT8E-4P-HU	758-0082-0			4	10.55±0.5	6	
GT8E-8P-HU	758-0038-8			8	18.55±0.7	14	

Note 1 : Applicable terminal is GT8E-2022PCF, GT8-2428PCF.

Note 2 : Applicable housing is GT8E-*S-2C.

●Full lock in-line type (water proof)

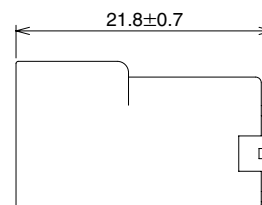
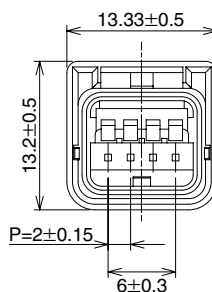
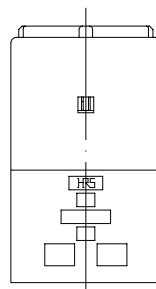

Plug	Applicable	Applicable conductor
GT8EW-4P-HU	AWG #20~22	GT8E-2022PCF

Part Number	CL No.	Number of contact	Packaging
GT8EW-4P-HU	7758-0069-1	4	1

Note 1 : Applicable terminal is GT8E-2022PCF.

Note 2 : Use this in combination with GT8EW-4P-R, GT8EW-4P/S-BR, GT8EW-4P/S-BHS.

Note 3 : Applicable housing is GT8EW-4S-HU.

●Full lock in-line socket (water proof)



Socket	Applicable	Applicable conductor
GT8EW-4S-HU	AWG #20~22	GT8-2022SCF

Part Number	CL No.	Number of contact	Packaging
GT8EW-4S-HU	758-0068-9	4	1

Note 1 : Applicable terminal is GT8E-2022SCF.

Note 2 : Use this in combination with GT8EW-4P-R, GT8EW-4P/S-BR, GT8EW-4P/S-BHS.

Note 3 : Applicable housing is GT8EW-4P-HU.

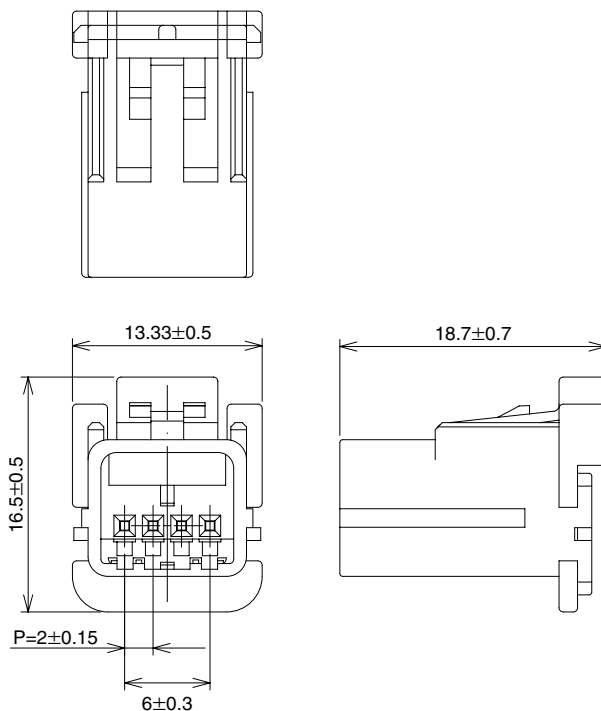

●Retainer (GT8EW-4P-HU)

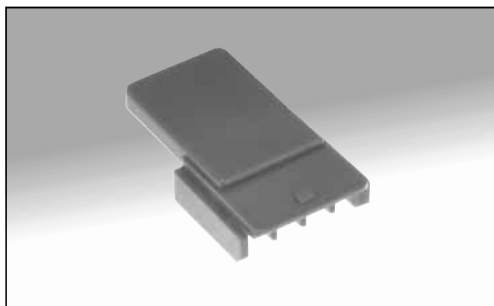

Part Number	CL No.	Packaging
GT8EW-4P-R	758-0077-0	1

Note 1 : Use this in combination with GT8EW-4P-HU.

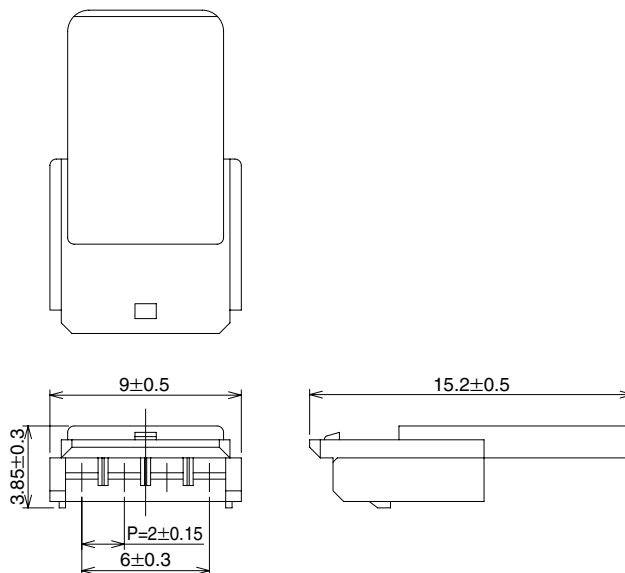

●Retainer (GT8EW-4S-HU)

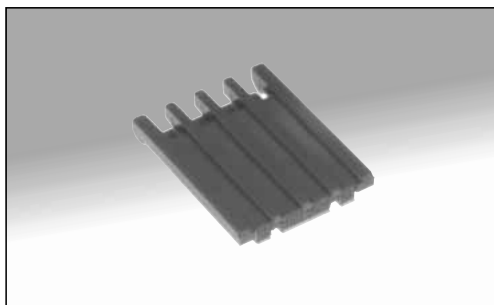

Part Number	CL No.	Packaging
GT8EW-4S-R	758-0076-7	1

Note 1 : Use this in combination with GT8EW-4S-HU.

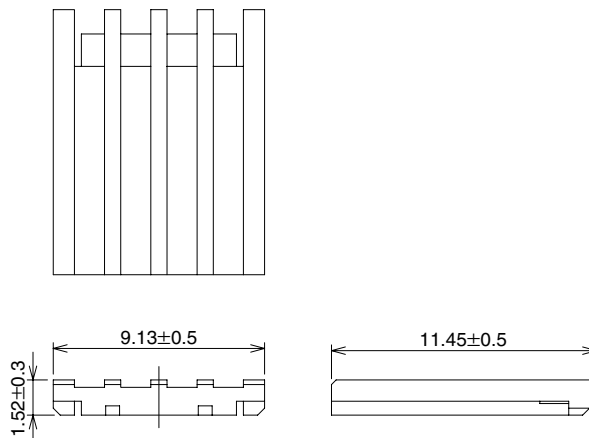

●Retainer (GT8EW-4P-HU, GT8EW-45-HU)

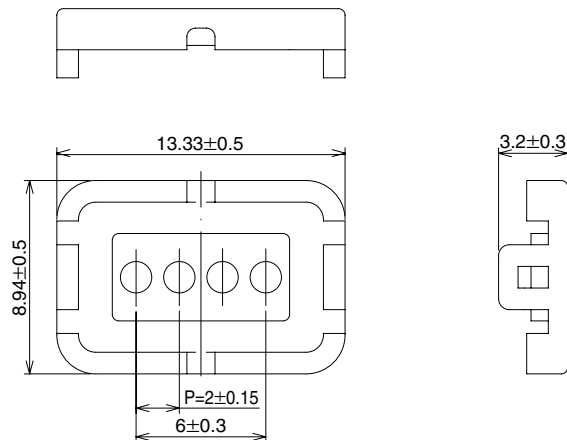

Part Number	CL No.	Packaging
GT8EW-4P/S-BR	758-0070-0	1

Note 1 : Use this in combination with GT8EW-4P-HU, GT8EW-4S-HU.

●Bushing (GT8EW-4P-HU, GT8EW-4S-HU)

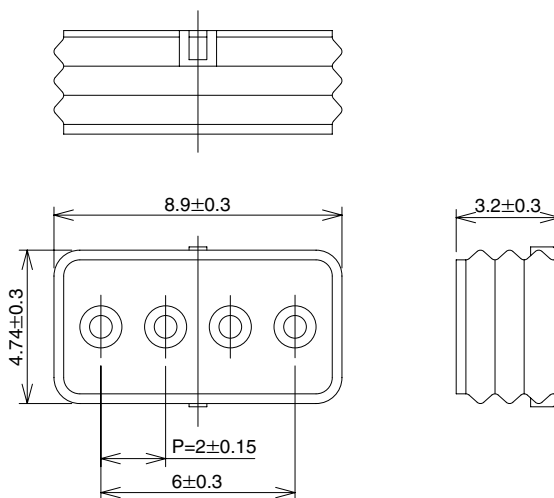

Part Number	CL No.	Packaging
GT8EW-4P/S-BHS	758-0071-3	1

Note 1 : Use this in combination with GT8EW-4P-HU, GT8EW-4S-HU.

■Full-lock in line waterproof connector use hand book



- ①Crimp the terminal and insert it into the in-line plug/socket. And mount the retainer.
- ②Fit the parts to the in-line plug/socket in following order: Bushing and Retainer

■ Crimping contact

● Crimping contact for socket

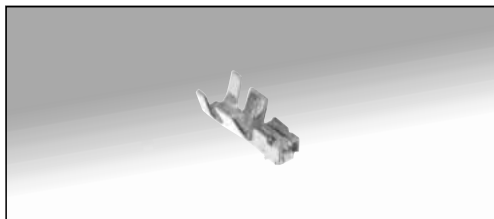

Part number	Materials	Finish	Packaging	Sockets
GT8-2428SCF(70)	Phosphor bronze	Tin plated	10,000pcs. per reel	GT8E-8DS-2C
GT8-2022SCF				GT8E-8DS-2C
GT8E-2022SCF				GT8E-*S-2C, GT8E-*S-HU, GT8E-*DS-HU
GT8B-2428SCF				GT8E-*S-2C, GT8E-*S-HU, GT8E-*DS-HU
GT8-2428SC(70)			100pcs. per bag	GT8E-8DS-2C

● Crimping contact for plug

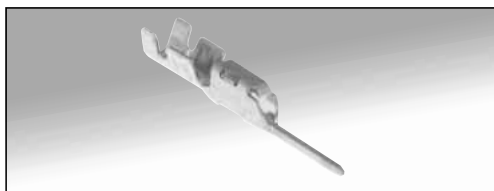

Part number	Materials	Finish	Packaging	Plugs
GT8E-2022PCF	Copper alloy	Tin plated	10,000pcs. per reel	GT8E-8P-HU, GT8EW-4P-HU
GT8E-2428PCF	Brass			GT8E-8P-HU
GT8E-2022PC	Copper alloy		100pcs. per bag	GT8E-8P-HU, GT8EW-4P-HU
GT8E-2428PC	Brass			GT8E-8P-HU

■ Termination tools

User's manuals are available. Please contact a Hirose Electric account representative.

● Automatic crimping machine



Specifications

Item	Specification	Remarks
Specification	1.5ton	
Stroke length	30mm	
Number of strokes	200 spm(50Hz)	240spm(60Hz)
Wight	75kg	
Motor	0.2kw	AC100V
Crimping speed	2,000 to 4,000 pieces/H	

Part number CM-105

Applicator product number
AP105-GT8-2428S

● Hand tool



Part Number	CL No.
HT102/GT8-2428S	—

* : Crimp height setting tables are available for each cable type. please contact your nearest Hirose Electric account representative. Different cables will requires different crimp height setting.

■ Temperature Profile

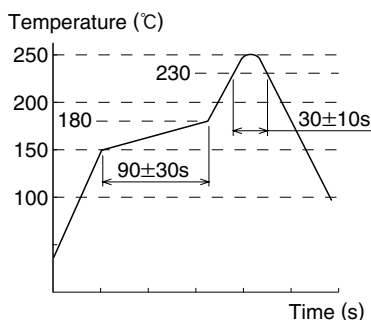

Solder method	: Reflow, IR/hot air
Reflow cycles	: 2 cycles
Peak temperature	: 250°C
230°C min.	: 20 sec. to 40 sec.
Pre-heat temperature	: 150°C to 180°C
Pre-heat time	: 60 sec. to 120 sec.



HIROSE ELECTRIC CO.,LTD.

5-23, OSAKI 5-CHOME, SHINAGAWA-KU, TOKYO 141-8587, JAPAN
 PHONE: 81-3-3491-5300, FAX: 81-3-3495-5230
<http://www.hirose.com>
<http://www.hirose-connectors.com>

Компания «Океан Электроники» предлагает заключение долгосрочных отношений при поставках импортных электронных компонентов на взаимовыгодных условиях!

Наши преимущества:

- Поставка оригинальных импортных электронных компонентов напрямую с производств Америки, Европы и Азии, а так же с крупнейших складов мира;
- Широкая линейка поставок активных и пассивных импортных электронных компонентов (более 30 млн. наименований);
- Поставка сложных, дефицитных, либо снятых с производства позиций;
- Оперативные сроки поставки под заказ (от 5 рабочих дней);
- Экспресс доставка в любую точку России;
- Помощь Конструкторского Отдела и консультации квалифицированных инженеров;
- Техническая поддержка проекта, помощь в подборе аналогов, поставка прототипов;
- Поставка электронных компонентов под контролем ВП;
- Система менеджмента качества сертифицирована по Международному стандарту ISO 9001;
- При необходимости вся продукция военного и аэрокосмического назначения проходит испытания и сертификацию в лаборатории (по согласованию с заказчиком);
- Поставка специализированных компонентов военного и аэрокосмического уровня качества (Xilinx, Altera, Analog Devices, Intersil, Interpoint, Microsemi, Actel, Aeroflex, Peregrine, VPT, Syfer, Eurofarad, Texas Instruments, MS Kennedy, Miteq, Cobham, E2V, MA-COM, Hittite, Mini-Circuits, General Dynamics и др.);

Компания «Океан Электроники» является официальным дистрибьютором и эксклюзивным представителем в России одного из крупнейших производителей разъемов военного и аэрокосмического назначения «**JONHON**», а так же официальным дистрибьютором и эксклюзивным представителем в России производителя высокотехнологичных и надежных решений для передачи СВЧ сигналов «**FORSTAR**».



JONHON

«**JONHON**» (основан в 1970 г.)

Разъемы специального, военного и аэрокосмического назначения:

(Применяются в военной, авиационной, аэрокосмической, морской, железнодорожной, горно- и нефтедобывающей отраслях промышленности)

«**FORSTAR**» (основан в 1998 г.)

ВЧ соединители, коаксиальные кабели, кабельные сборки и микроволновые компоненты:

(Применяются в телекоммуникациях гражданского и специального назначения, в средствах связи, РЛС, а так же военной, авиационной и аэрокосмической отраслях промышленности).



Телефон: 8 (812) 309-75-97 (многоканальный)

Факс: 8 (812) 320-03-32

Электронная почта: ocean@oceanchips.ru

Web: <http://oceanchips.ru/>

Адрес: 198099, г. Санкт-Петербург, ул. Калинина, д. 2, корп. 4, лит. А