

### General Description

Qorvo's QPD1009 is a 15 W ( $P_{3dB}$ ) wideband unmatched discrete GaN on SiC HEMT which operates from DC to 4 GHz and a 50V supply rail. The device is an industry standard 3x3 mm plastic overmold package and is ideally suited to military and civilian radar, land mobile and military radio communications, wireless infrastructure communications, avionics, and test instrumentation. The device can support pulsed, CW and linear operations.

Lead-free and ROHS compliant.

Evaluation boards are available upon request.

### Functional Block Diagram

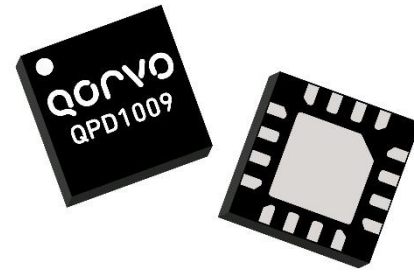
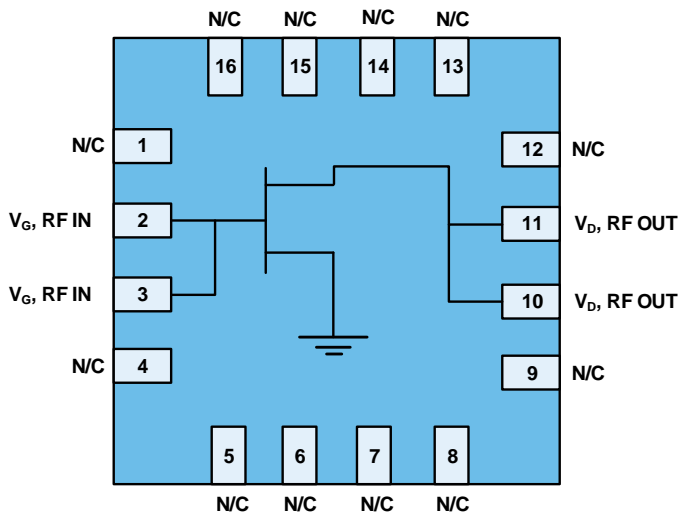

3 x 3 x 0.100 mm

### Product Features

- Frequency: DC to 4 GHz
- Output Power ( $P_{3dB}$ ): 17 W at 2 GHz
- Linear Gain: 24 dB at 2 GHz
- Typical  $PAE_{3dB}$ : 72% at 2 GHz
- Operating Voltage: 50 V
- Low thermal resistance package
- CW and Pulse capable
- 3 x 3 mm package

### Applications

- Military radar
- Civilian radar
- Land mobile and military radio communications
- Test instrumentation
- Wideband or narrowband amplifiers
- Jammers

### Ordering info

Part No.	Description
QPD1009	DC-4 GHz RF Transistor
1132871	0.96 – 1.215 GHz EVB
QPD1009EVB02	1.1 – 1.7 GHz EVB

## Absolute Maximum Ratings<sup>1</sup>

Parameter	Rating	Units
Breakdown Voltage, $BV_{DG}$	+145	V
Gate Voltage Range, $V_G$	-7 to +2	V
Drain Current, $I_{DSS}$	1600	mA
Gate Current Range, $I_G$	See page 4.	mA
Power Dissipation, CW, $P_{DISS}$	16	W
RF Input Power at 2 GHz, CW, 50 $\Omega$ , $T = 25^\circ\text{C}$	+27	dBm
Mounting Temperature (30 Seconds)	320	$^\circ\text{C}$
Storage Temperature	-40 to +150	$^\circ\text{C}$

Notes:

1. . Operation of this device outside the parameter ranges given above may cause permanent damage.

## Recommended Operating Conditions<sup>1</sup>

Parameter	Min	Typ	Max	Units
Operating Temp. Range	-40	+25	+85	$^\circ\text{C}$
Drain Voltage Range, $V_D$	+12	+50	+60	V
Drain Bias Current, $I_{DQ}$	–	26	–	mA
Drain Current, $I_D$	–	700	–	mA
Gate Voltage, $V_G$	–	-2.8	–	V
Power Dissipation, CW ( $P_D$ ) <sup>2</sup>	–	–	14.4	W
Power Dissipation, Pulsed ( $P_D$ ) <sup>2, 3</sup>	–	–	17.5	W

Notes:

1. Electrical performance is measured under conditions noted in the electrical specifications table. Specifications are not guaranteed over all recommended operating conditions.
2. Package at 85  $^\circ\text{C}$
3. Pulse Width = 128  $\mu\text{s}$ , Duty Cycle = 10%

### Pulsed Characterization – Load Pull Performance – Power Tuned

Parameters	Typical Values					Unit
	1	2	3	3.5	4	
Frequency, F	1	2	3	3.5	4	GHz
Linear Gain, $G_{LIN}$	27	23.7	20.9	19.7	18.7	dB
Output Power at 3dB compression point, $P_{3dB}$	41.9	42.4	42.4	42.2	41.8	dBm
Power-Added-Efficiency at 3dB compression point, $PAE_{3dB}$	64.1	67.3	61.4	56.9	50.0	%
Gain at 3dB compression point	24	20.7	17.9	16.7	15.7	dB

Notes:

1. Test conditions unless otherwise noted:  $V_D = +50\text{ V}$ ,  $I_{DQ} = 26\text{ mA}$ ,  $Temp = +25\text{ }^\circ\text{C}$

### Pulsed Characterization – Load Pull Performance – Efficiency Tuned

Parameters	Typical Values					Unit
	1	2	3	3.5	4	
Frequency	1	2	3	3.5	4	GHz
Linear Gain, $G_{LIN}$	26.8	24.0	21.8	20.5	19.3	dB
Output Power at 3dB compression point, $P_{3dB}$	40	41.9	40.9	40.7	41.2	dBm
Power-Added-Efficiency at 3dB compression point, $PAE_{3dB}$	77.8	72.4	69.6	63.3	54.6	%
Gain at 3dB compression point, $G_{3dB}$	23.8	21.0	18.8	17.5	16.3	dB

Notes:

1. Test conditions unless otherwise noted:  $V_D = +50\text{ V}$ ,  $I_{DQ} = 26\text{ mA}$ ,  $Temp = +25\text{ }^\circ\text{C}$

### RF Characterization – 0.96 – 1.215 GHz EVB Performance At 1.09 GHz<sup>1</sup>

Parameter	Min	Typ	Max	Units
Linear Gain, $G_{LIN}$	–	19.5	–	dB
Output Power at 3dB compression point, $P_{3dB}$	–	41.4	–	dBm
Drain Efficiency at 3dB compression point, $DEFF_{3dB}$	–	53.9	–	%
Gain at 3dB compression point, $G_{3dB}$	–	16.5	–	dB

Notes:

1.  $V_D = +50\text{ V}$ ,  $I_{DQ} = 26\text{ mA}$ ,  $Temp = +25\text{ }^\circ\text{C}$ , Pulse Width = 128  $\mu\text{s}$ , Duty Cycle = 10%

### RF Characterization – Mismatch Ruggedness at 1.09 GHz

Symbol	Parameter	dB Compression	Typical
VSWR	Impedance Mismatch Ruggedness	3	10:1

Test conditions unless otherwise noted:  $T_A = 25\text{ }^\circ\text{C}$ ,  $V_D = 50\text{ V}$ ,  $I_{DQ} = 26\text{ mA}$

Driving input power is determined at pulsed compression under matched condition at EVB output connector.

**Maximum Gate Current**

---

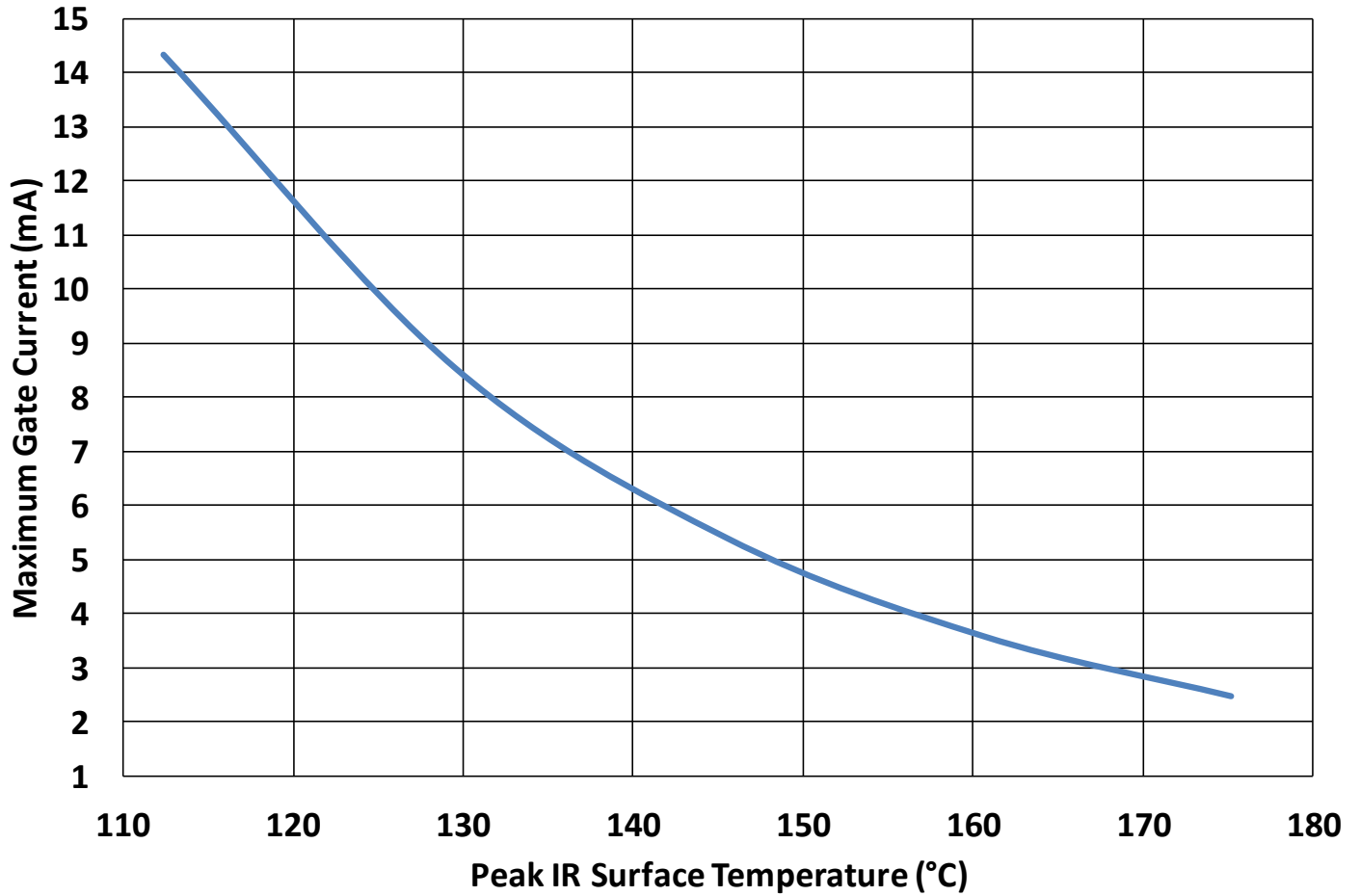
**Maximum Gate Current Vs. Peak IR Surface Temperature**

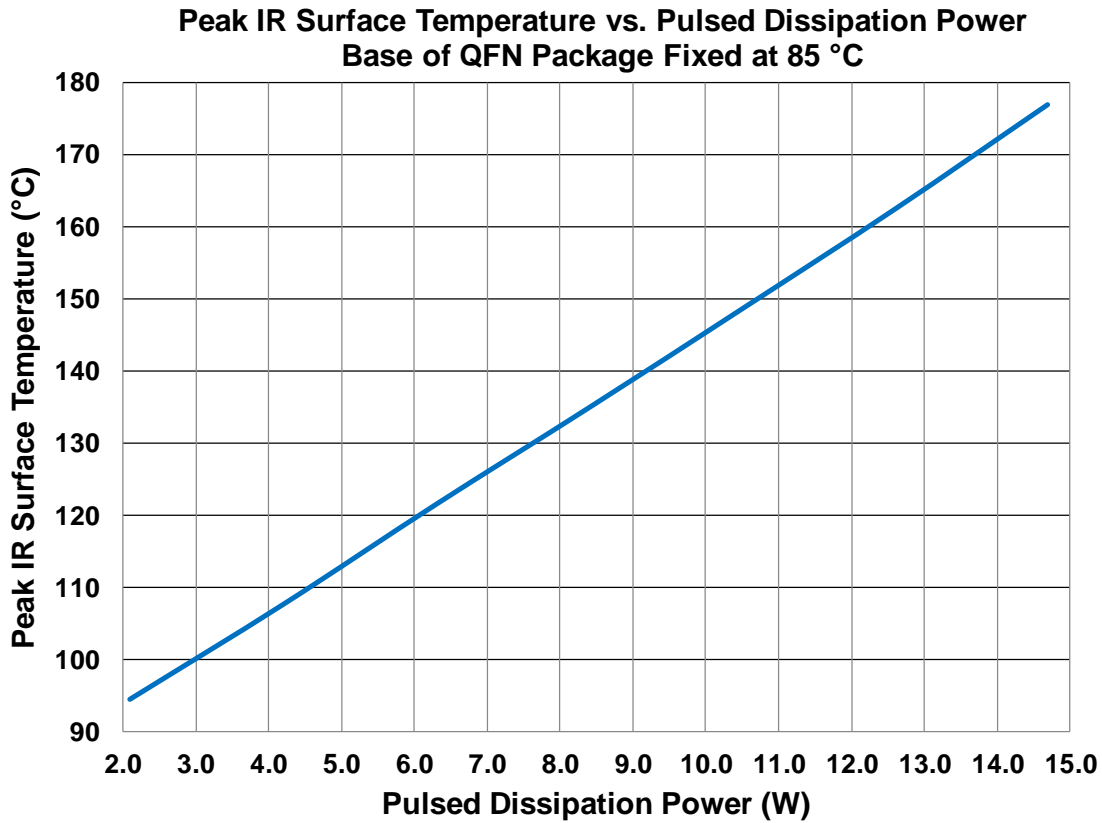
**Thermal and Reliability Information - Pulsed**

Parameter	Conditions	Values	Units
Thermal Resistance, IR <sup>1</sup> ( $\theta_{JC}$ )	85 °C Case	5.48	°C/W
Peak IR Surface Temperature <sup>1</sup> ( $T_{CH}$ )	4.2 W Pdiss, 128 uS PW, 10%	108	°C
Thermal Resistance, IR <sup>1</sup> ( $\theta_{JC}$ )	85 °C Case	5.87	°C/W
Peak IR Surface Temperature <sup>1</sup> ( $T_{CH}$ )	6.3 W Pdiss, 128 uS PW, 10%	122	°C
Thermal Resistance, IR <sup>1</sup> ( $\theta_{JC}$ )	85 °C Case	5.95	°C/W
Peak IR Surface Temperature <sup>1</sup> ( $T_{CH}$ )	8.4 W Pdiss, 128 uS PW, 10%	135	°C
Thermal Resistance, IR <sup>1</sup> ( $\theta_{JC}$ )	85 °C Case	6.10	°C/W
Peak IR Surface Temperature <sup>1</sup> ( $T_{CH}$ )	10.5 W Pdiss, 128 uS PW, 10%	149	°C
Thermal Resistance, IR <sup>1</sup> ( $\theta_{JC}$ )	85 °C Case	6.11	°C/W
Peak IR Surface Temperature <sup>1</sup> ( $T_{CH}$ )	12.6 W Pdiss, 128 uS PW, 10%	162	°C
Thermal Resistance, IR <sup>1</sup> ( $\theta_{JC}$ )	85 °C Case	6.26	°C/W
Peak IR Surface Temperature <sup>1</sup> ( $T_{CH}$ )	14.7 W Pdiss, 128 uS PW, 10%	177	°C

<sup>1</sup>Refer to the following document [GaN Device Channel Temperature, Thermal Resistance, and Reliability Estimates](#)

**Thermal and Reliability Information - CW**

**Peak IR Surface Temperature vs. CW Dissipation Power  
Base of QFN Package Fixed at 85 °C**

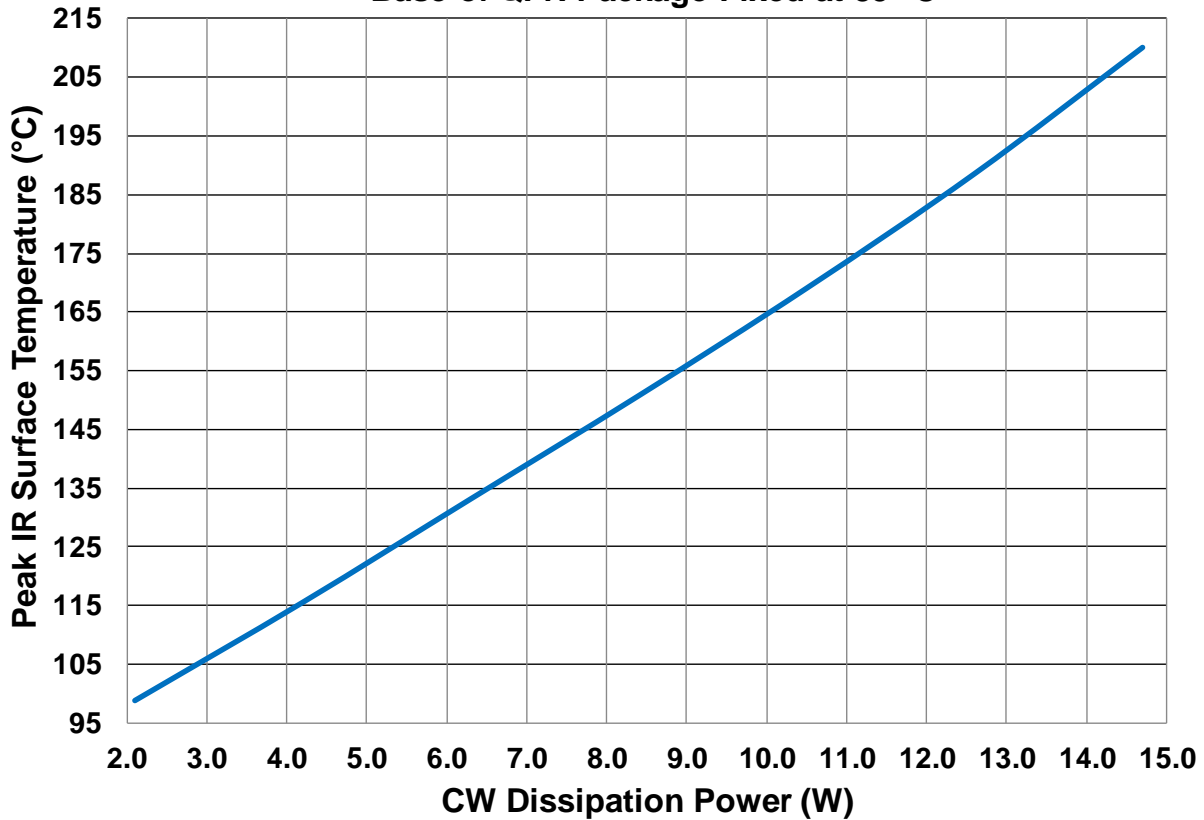

Parameter	Conditions	Values	Units
Thermal Resistance, IR <sup>1</sup> ( $\theta_{JC}$ )	85 °C Case	7.38	°C/W
Peak IR Surface Temperature <sup>1</sup> ( $T_{CH}$ )	4.2 W Pdiss, CW	116	°C
Thermal Resistance, IR <sup>1</sup> ( $\theta_{JC}$ )	85 °C Case	7.62	°C/W
Peak IR Surface Temperature <sup>1</sup> ( $T_{CH}$ )	6.3 W Pdiss, CW	133	°C
Thermal Resistance, IR <sup>1</sup> ( $\theta_{JC}$ )	85 °C Case	7.86	°C/W
Peak IR Surface Temperature <sup>1</sup> ( $T_{CH}$ )	8.4 W Pdiss, CW	151	°C
Thermal Resistance, IR <sup>1</sup> ( $\theta_{JC}$ )	85 °C Case	8.00	°C/W
Peak IR Surface Temperature <sup>1</sup> ( $T_{CH}$ )	10.5 W Pdiss, CW	169	°C
Thermal Resistance, IR <sup>1</sup> ( $\theta_{JC}$ )	85 °C Case	8.25	°C/W
Peak IR Surface Temperature <sup>1</sup> ( $T_{CH}$ )	12.6 W Pdiss, CW	189	°C
Thermal Resistance, IR <sup>1</sup> ( $\theta_{JC}$ )	85 °C Case	8.50	°C/W
Peak IR Surface Temperature <sup>1</sup> ( $T_{CH}$ )	14.7 W Pdiss, CW	210	°C

<sup>1</sup>Refer to the following document [GaN Device Channel Temperature, Thermal Resistance, and Reliability Estimates](#)

### Load Pull Smith Charts<sup>1, 2, 3</sup>

Notes:

1.  $V_d = 50\text{ V}$ ,  $I_{DQ} = 26\text{ mA}$ , Pulsed signal with 128  $\mu\text{s}$  pulse width and 10 % duty cycle. Performance is at indicated input power.
2. See page 18 for load pull and source pull reference planes. 20- $\Omega$  load pull TRL fixtures are built with 20-mil RO4350B material.
3. NaN means the impedances are either undefined or varying in load-pull system.

### 1GHz, Load-pull

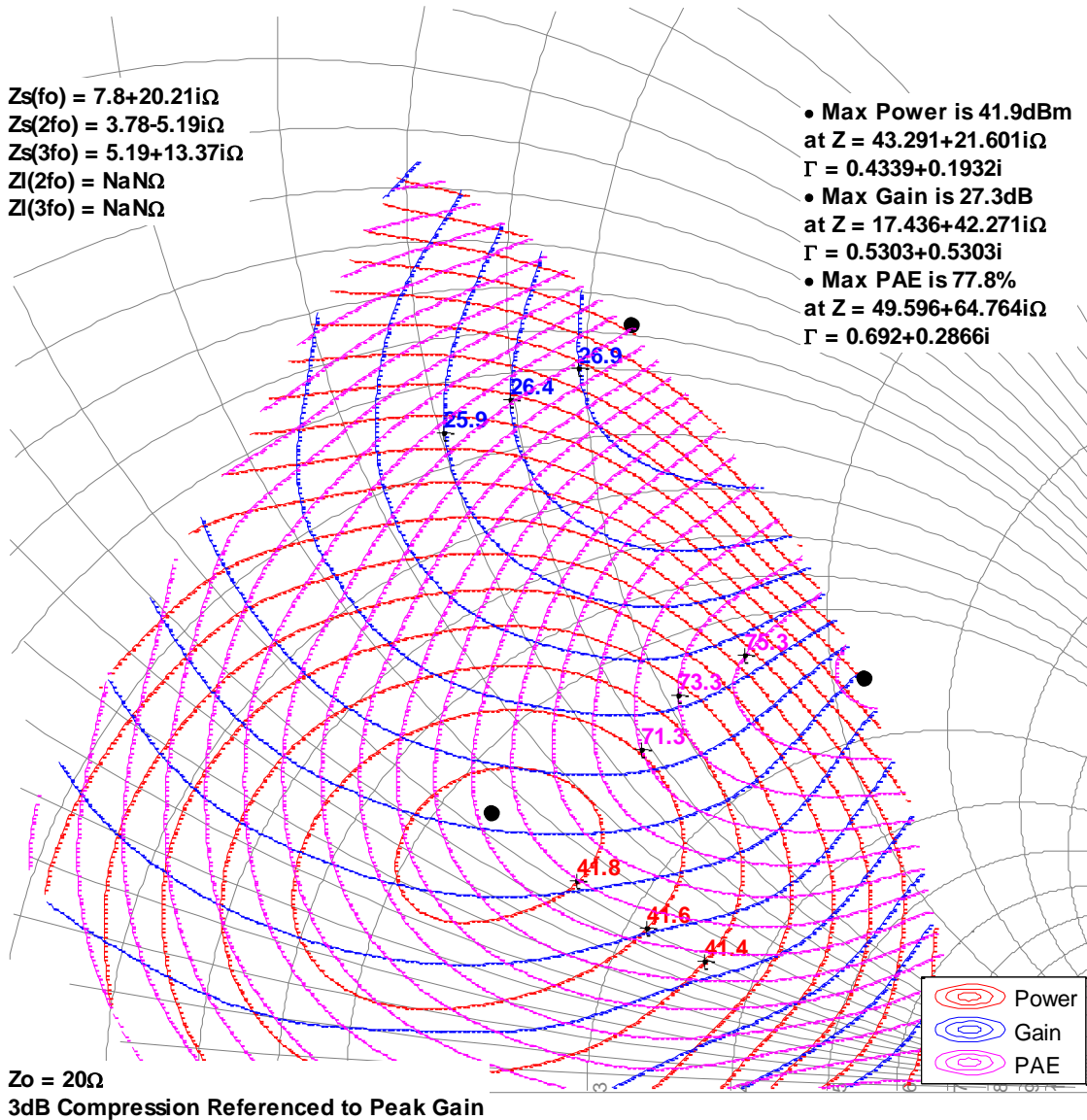

### Load Pull Smith Charts<sup>1, 2, 3</sup>

Notes:

1.  $V_d = 50\text{ V}$ ,  $I_{DQ} = 26\text{ mA}$ , Pulsed signal with 128  $\mu\text{s}$  pulse width and 10 % duty cycle. Performance is at indicated input power.
2. See page 18 for load pull and source pull reference planes. 20- $\Omega$  load pull TRL fixtures are built with 20-mil RO4350B material.
3. NaN means the impedances are either undefined or varying in load-pull system.

### 2GHz, Load-pull

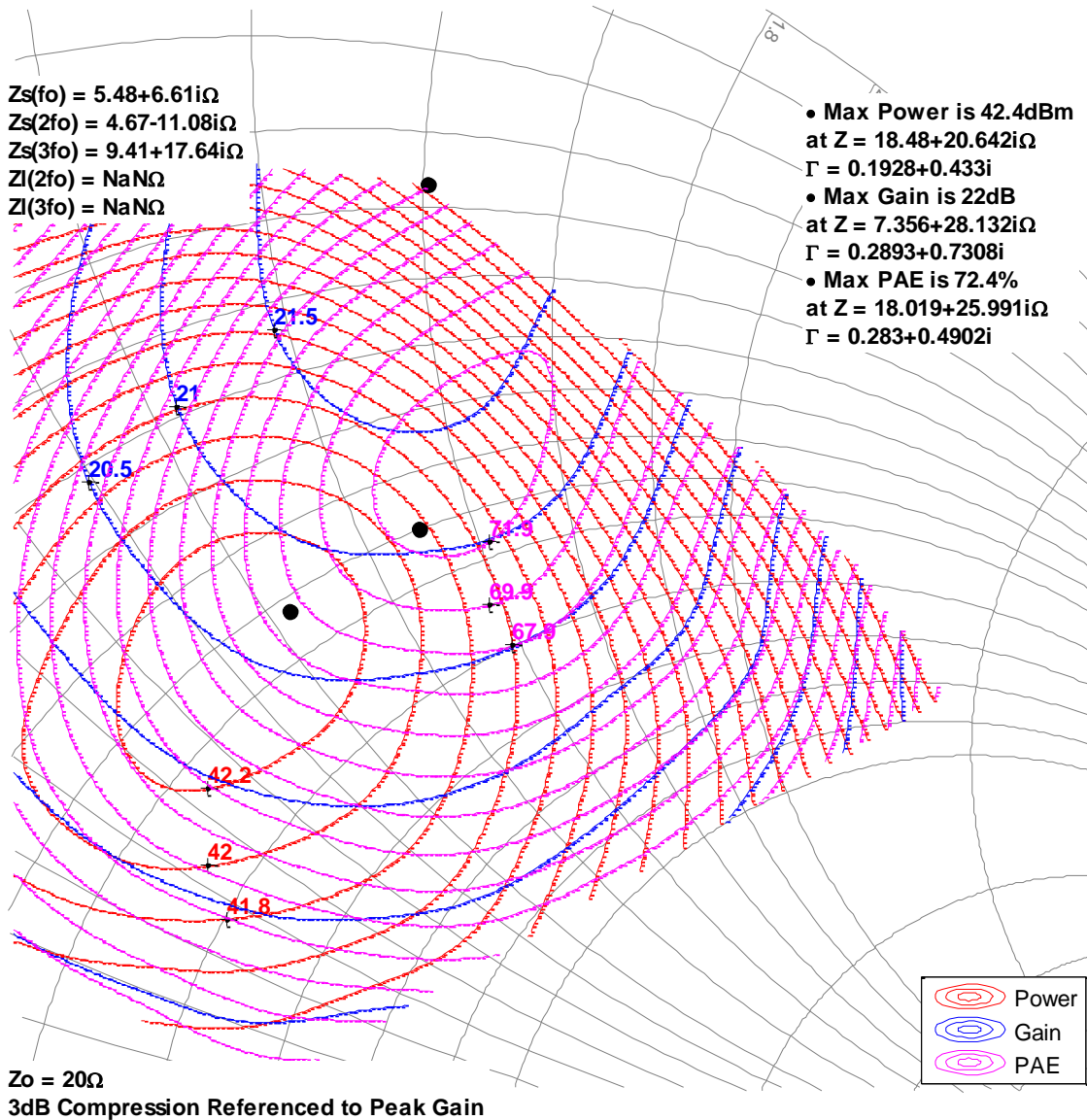



**Load Pull Smith Charts<sup>1, 2, 3</sup>**

Notes:

1.  $V_d = 50\text{ V}$ ,  $I_{DQ} = 26\text{ mA}$ , Pulsed signal with 128  $\mu\text{s}$  pulse width and 10 % duty cycle. Performance is at indicated input power.
2. See page 18 for load pull and source pull reference planes. 20- $\Omega$  load pull TRL fixtures are built with 20-mil RO4350B material.
3. NaN means the impedances are either undefined or varying in load-pull system.

**3GHz, Load-pull**

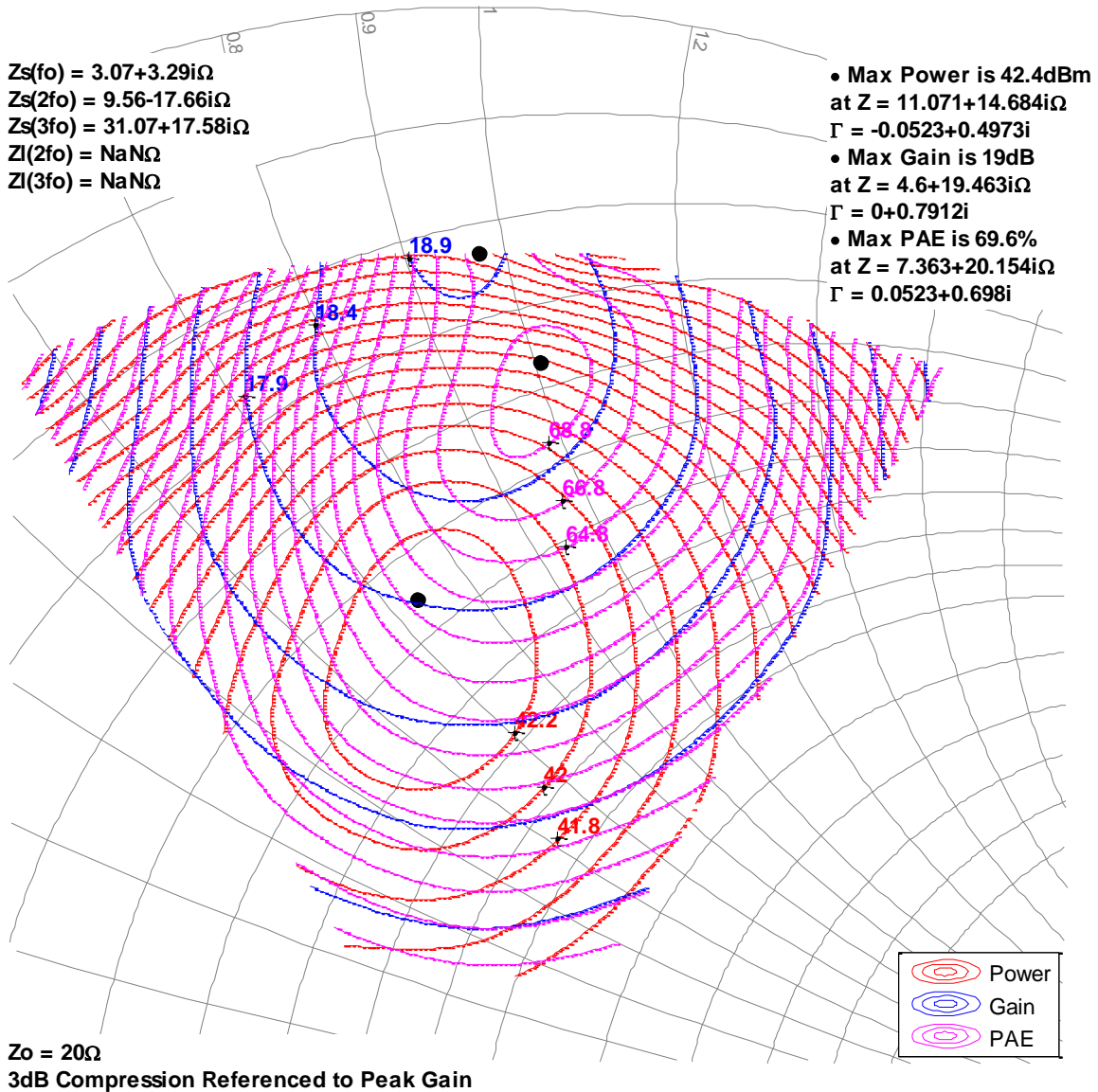

**Load Pull Smith Charts<sup>1, 2, 3</sup>**

Notes:

1. Vd = 50 V, IdQ = 26 mA, Pulsed signal with 128 uS pulse width and 10 % duty cycle. Performance is at indicated input power.
2. See page 18 for load pull and source pull reference planes. 20-Ω load pull TRL fixtures are built with 20-mil RO4350B material.
3. NaN means the impedances are either undefined or varying in load-pull system.

**3.5GHz, Load-pull**

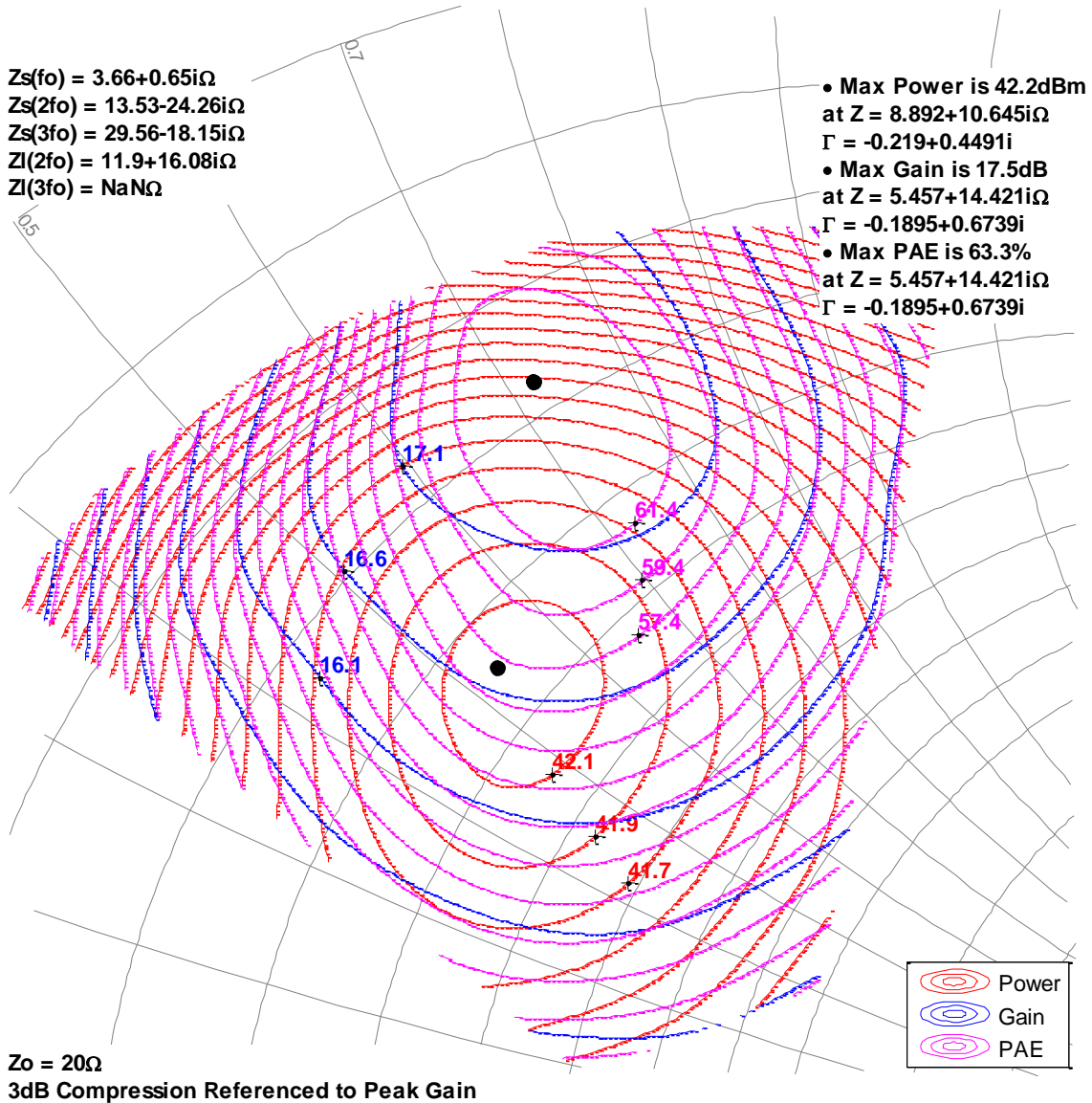

**Load Pull Smith Charts<sup>1, 2, 3</sup>**

Notes:

1.  $V_d = 50\text{ V}$ ,  $I_{DQ} = 26\text{ mA}$ , Pulsed signal with 128  $\mu\text{s}$  pulse width and 10 % duty cycle. Performance is at indicated input power.
2. See page 18 for load pull and source pull reference planes. 20- $\Omega$  load pull TRL fixtures are built with 20-mil RO4350B material.
3. NaN means the impedances are either undefined or varying in load-pull system.

**4GHz, Load-pull**

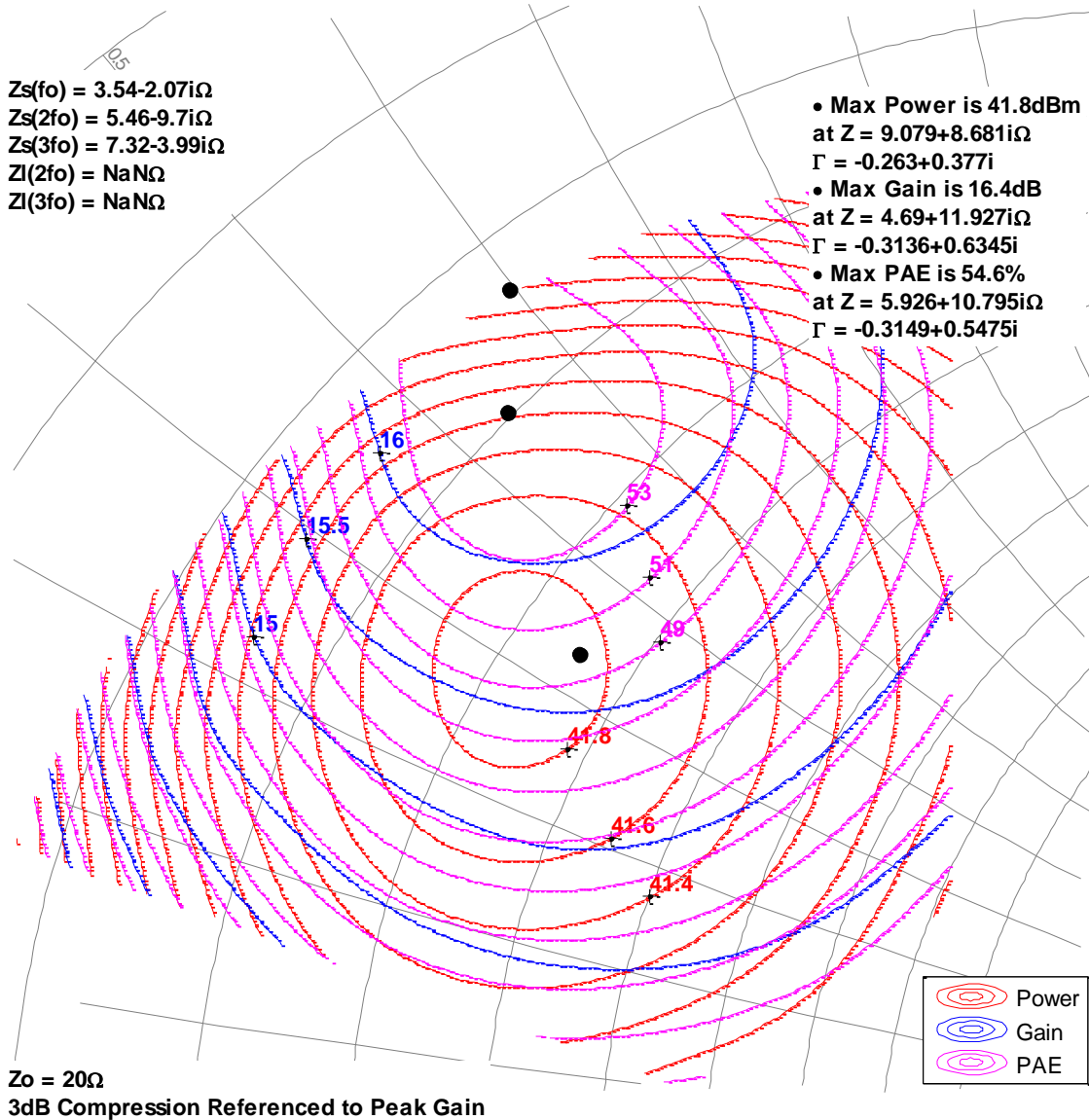

### Typical Performance – Load Pull Drive-up

Notes:

1. Pulsed signal with 128 uS pulse width and 10 % duty cycle,  $V_d = 50\text{ V}$ ,  $I_{DQ} = 26\text{ mA}$
2. See page 18 for load pull and source pull reference planes where the performance was measured.

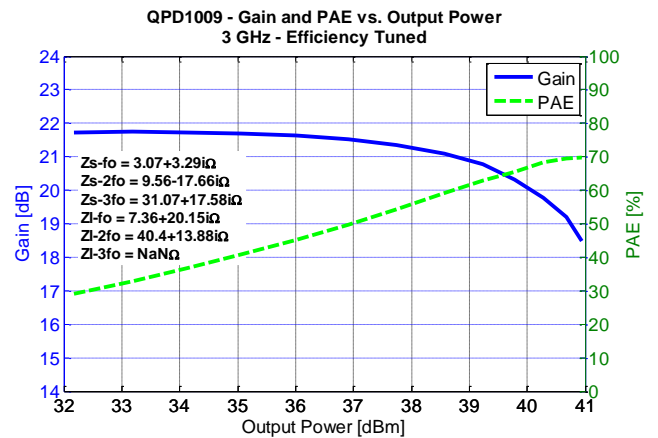
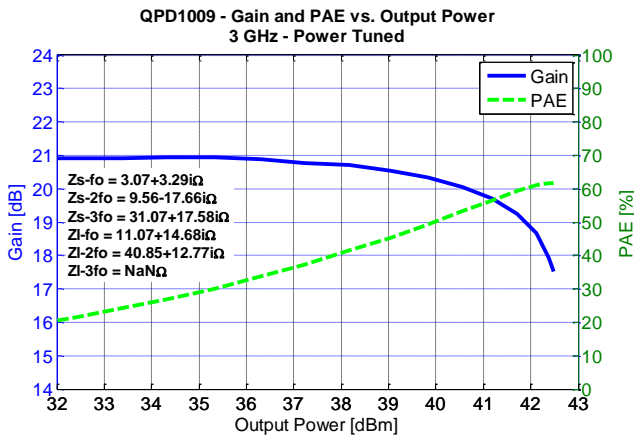
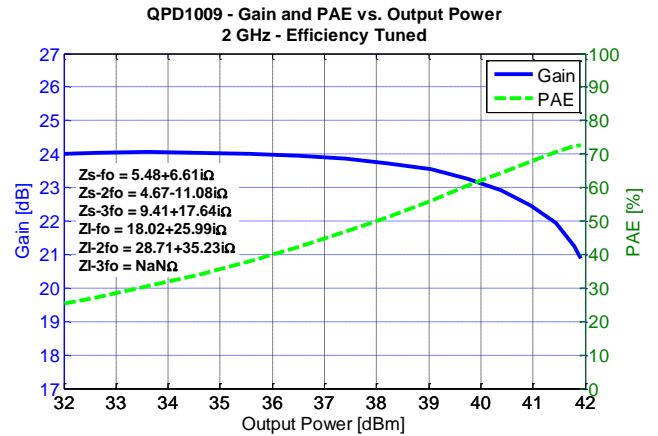
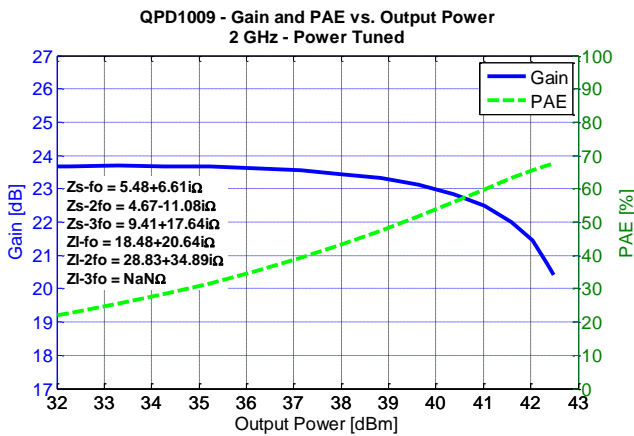
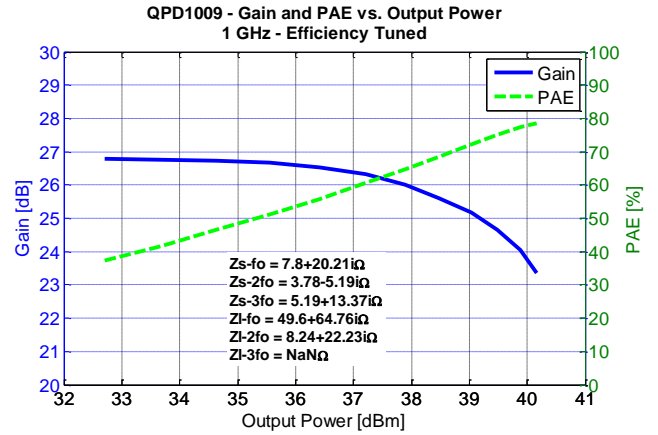
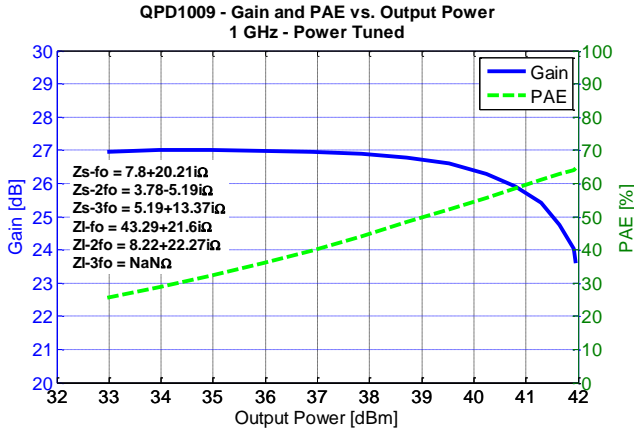

### Typical Performance – Load Pull Drive-up

Notes:

- Pulsed signal with 128 uS pulse width and 10 % duty cycle,  $V_d = 50\text{ V}$ ,  $I_{DQ} = 26\text{ mA}$
- See page 18 for load pull and source pull reference planes where the performance was measured.

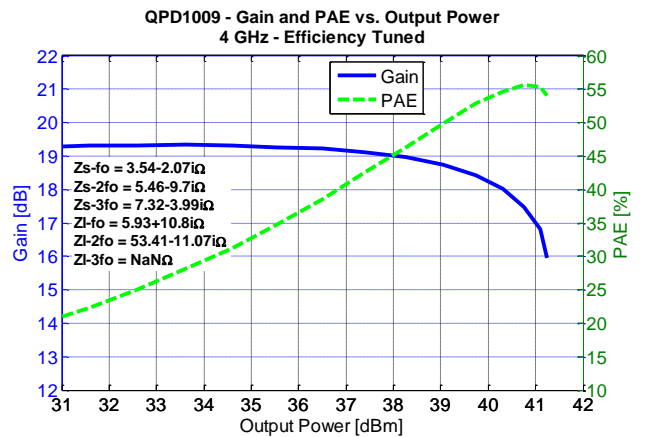
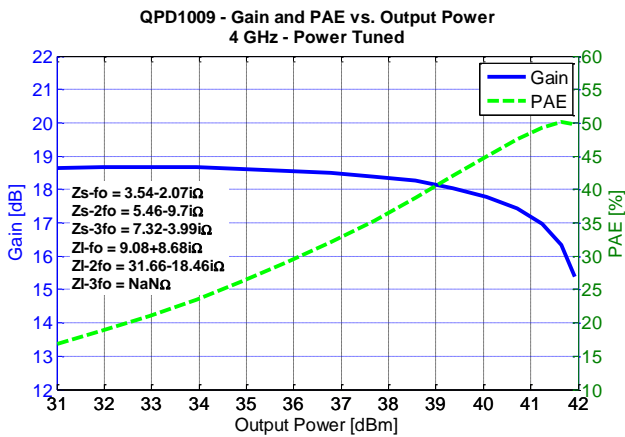
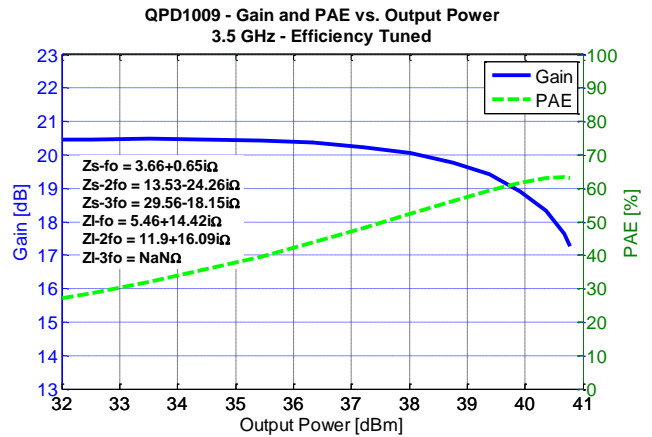
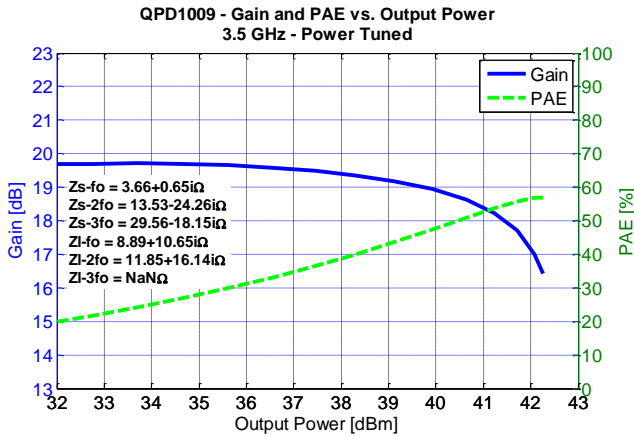

### Power Driveup Performance Over Temperatures Of 0.96 – 1.215 GHz EVB<sup>1</sup>

<sup>1</sup> Vd = 50 V, IdQ = 26 mA, Pulse Width = 128 uS, Duty Cycle = 10 %

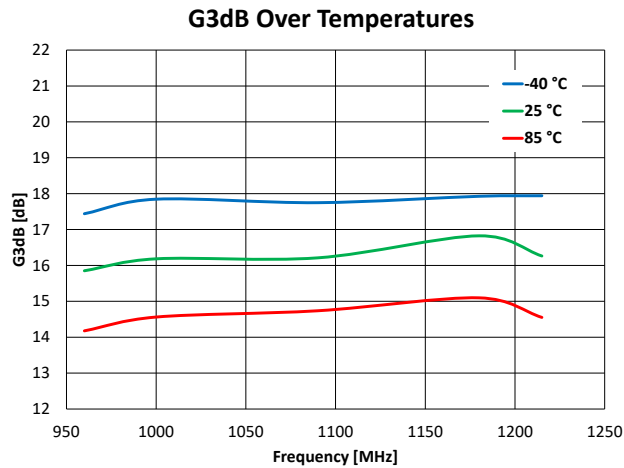
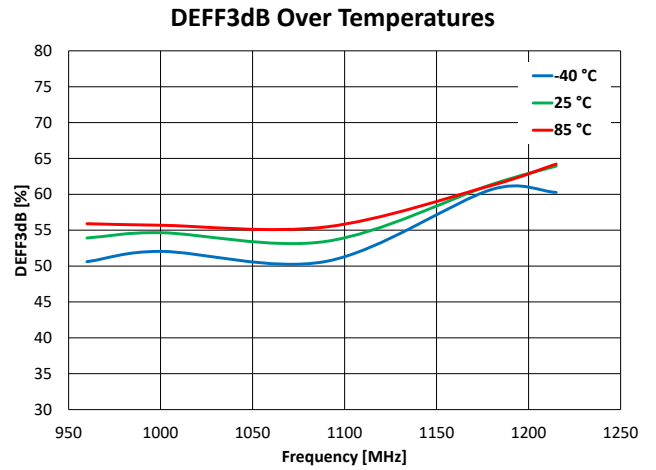
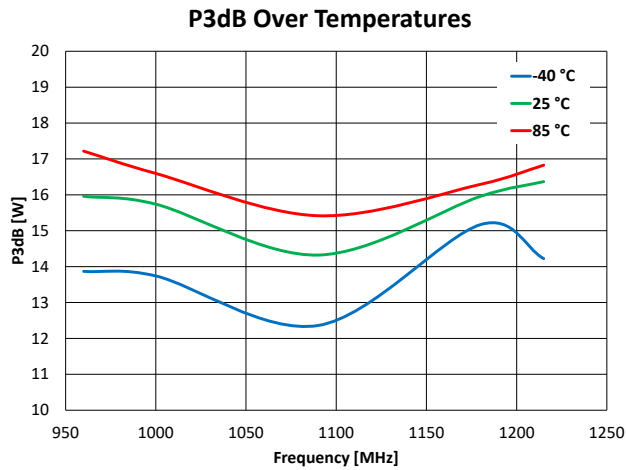

### Power Driveup Performance At 25 °C Of 0.96 – 1.215 GHz EVB<sup>1</sup>

<sup>1</sup> Vd = 50 V, IdQ = 26 mA, Pulse Width = 128 uS, Duty Cycle = 10 %

**P3dB At 25 °C**

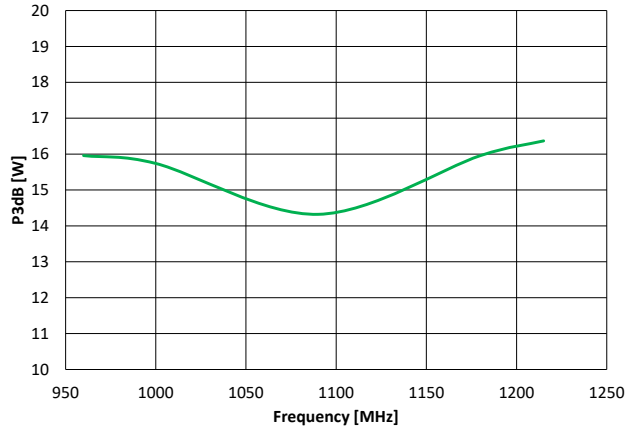

**DEFF3dB At 25 °C**

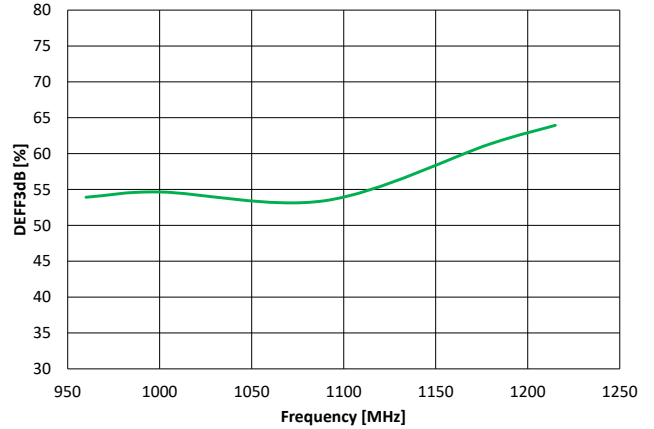

**G3dB At 25 °C**

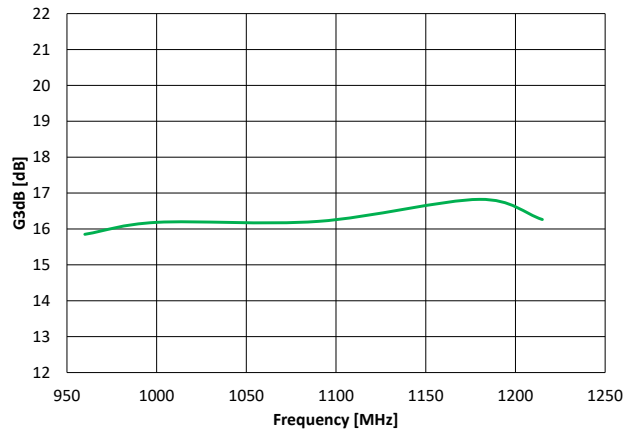

**Two-Tone Performance At 25 °C Of 0.96 – 1.215 GHz EVB<sup>1</sup>**

<sup>1</sup> Center frequency = 1.09 GHz, Tone Separation = 1 MHz

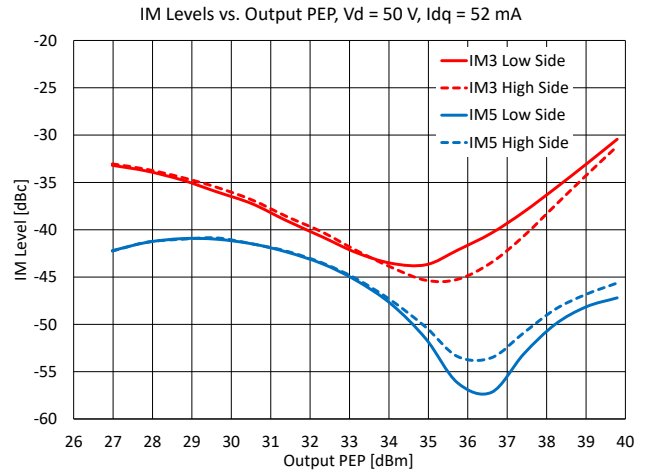
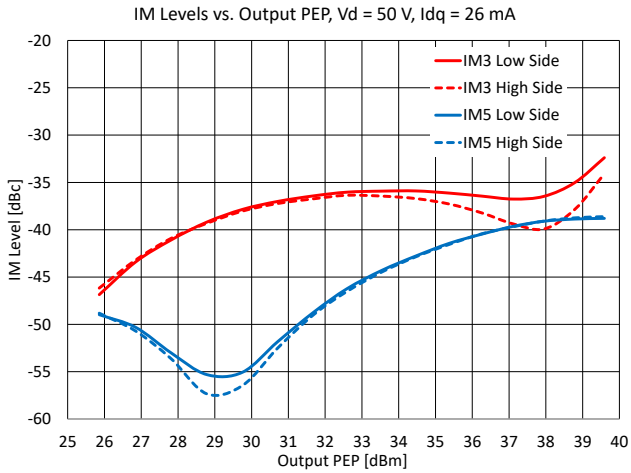



### Power Driveup Performance At 25 °C Of 1.1 – 1.7 GHz EVB<sup>1</sup>

<sup>1</sup> Vd = 50 V, Idq = 26 mA, Pulse Width = 128 uS, Duty Cycle = 10 %

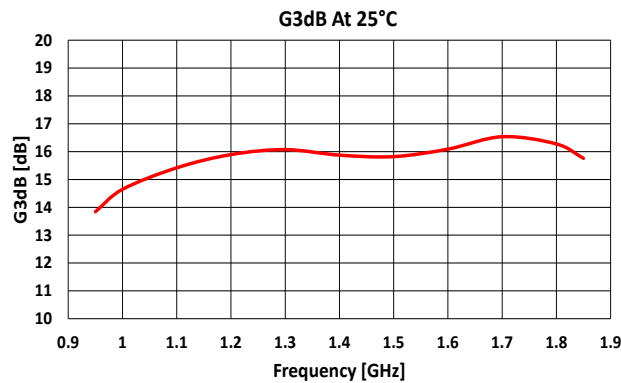
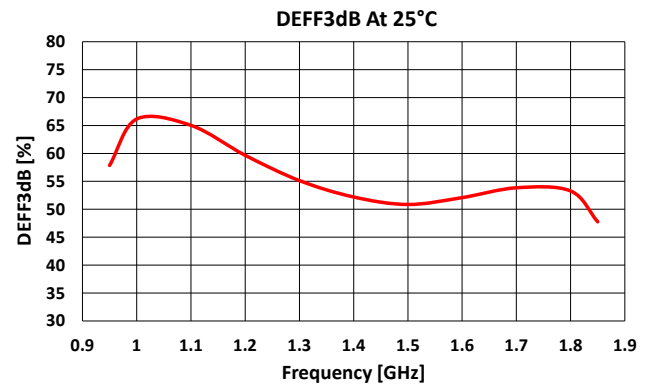
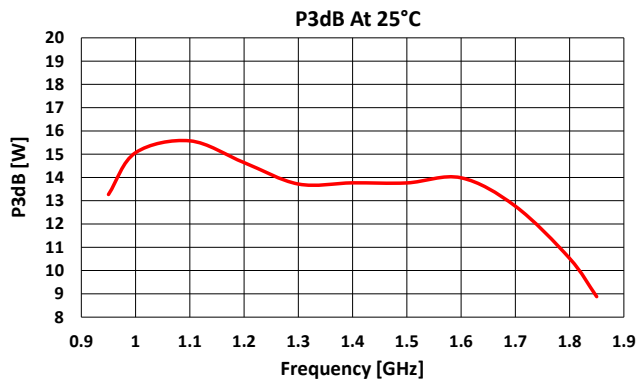

## Pin Layout <sup>1</sup>

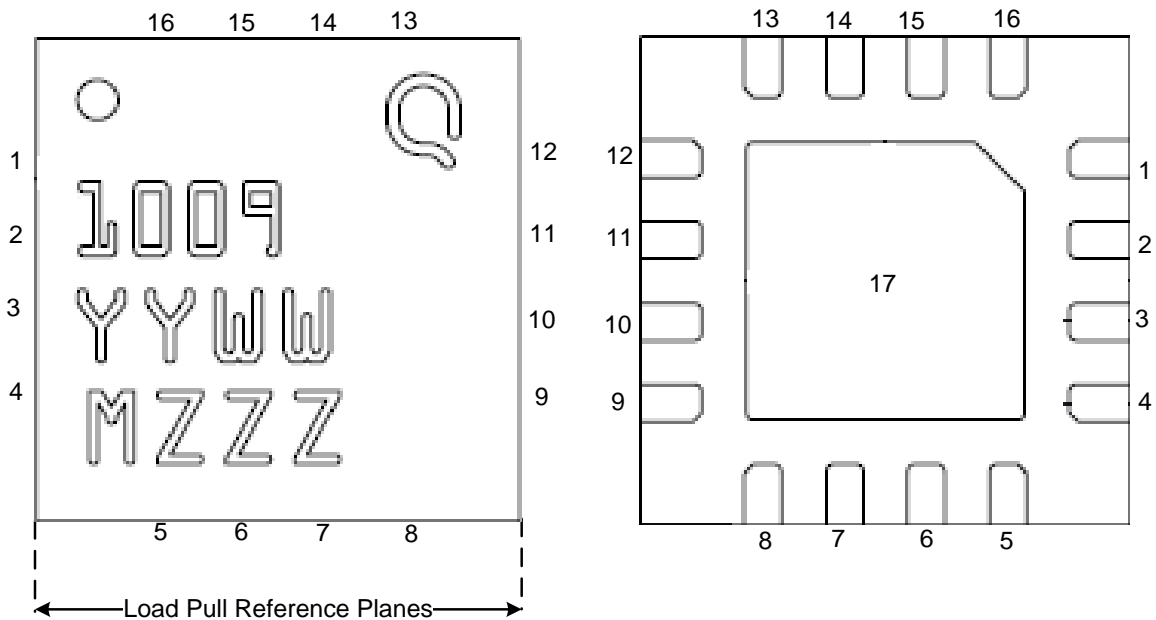

**Notes:**

- The QPD1009 will be marked with the “1009” designator and a lot code marked below the part designator. The “YY” represents the last two digits of the calendar year the part was manufactured, the “WW” is the work week of the assembly lot start, the “MXXX” is the production lot number, and the “ZZZ” is an auto-generated serial number.

## Pin Description

Pin	Symbol	Description
2, 3	VG / RF IN	Gate voltage / RF Input
10, 11	VD / RF OUT	Drain voltage / RF Output
1, 4, 5 – 9, 12 - 16	NC	Not Connected
17	Flange	Source to be connected to ground

**Mechanical Drawing<sup>1, 2, 3</sup>**

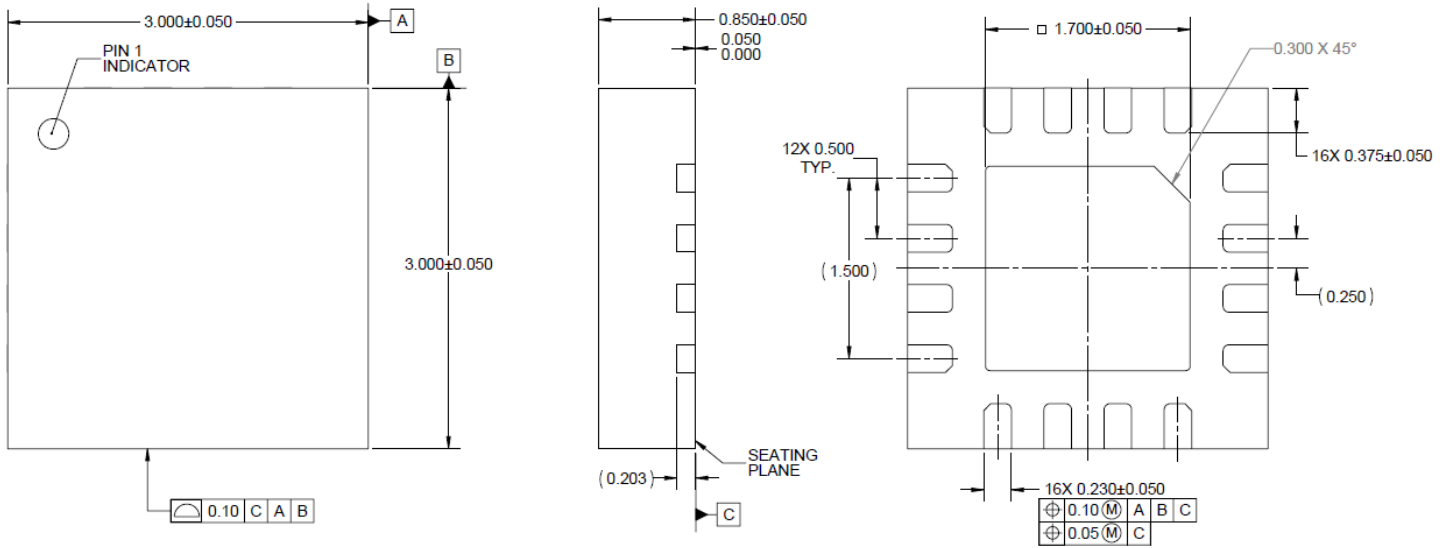

**Notes:**

1. All dimensions are in mm. Otherwise noted, the tolerance is  $\pm 0.100$  mm.
2. Package leads are gold plated.
3. Part is mold encapsulated.

## Schematic - 0.96 – 1.215 GHz EVB

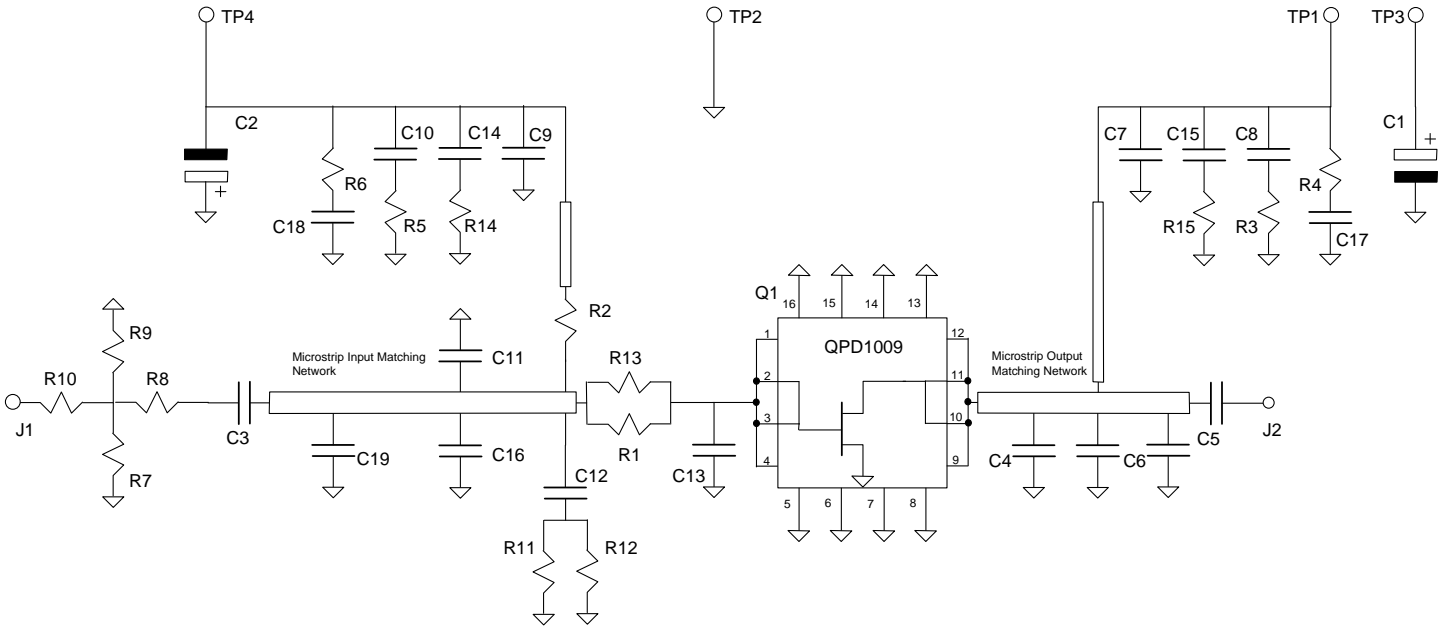

Bias-up Procedure	Bias-down Procedure
1. Set $V_G$ to -4 V.	1. Turn off RF signal.
2. Set $I_D$ current limit to 30 mA.	2. Turn off $V_D$
3. Apply 50 V $V_D$ .	3. Wait 2 seconds to allow drain capacitor to discharge
4. Slowly adjust $V_G$ until $I_D$ is set to 26 mA.	4. Turn off $V_G$
5. Set $I_D$ current limit to 1.5 A	
6. Apply RF.	

### PCB Layout - 0.96 – 1.215 GHz EVB

Board material is RO4360G2 0.020" thickness with 1 oz copper cladding.

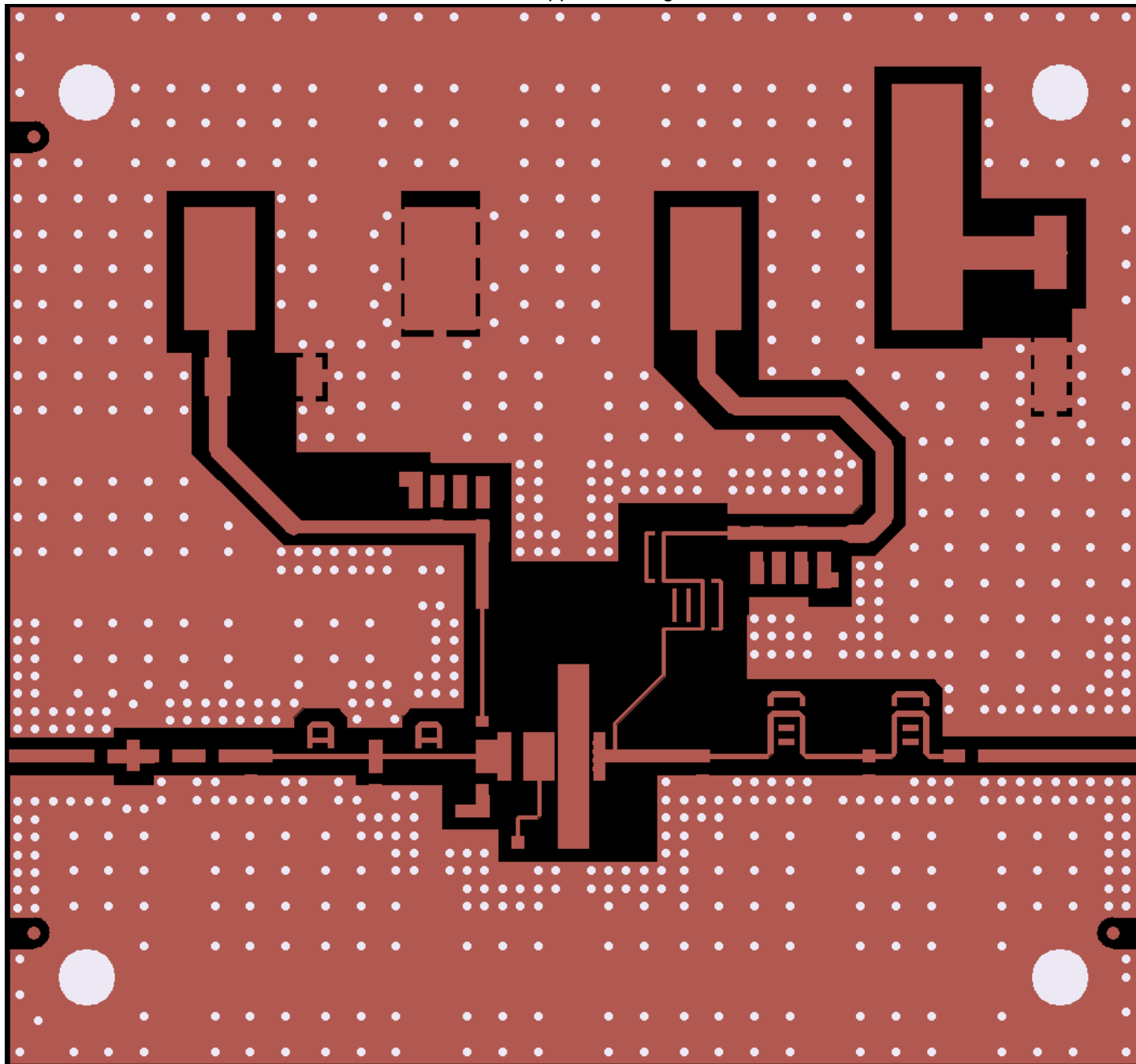

**Component Placement - 0.96 – 1.215 GHz EVB**

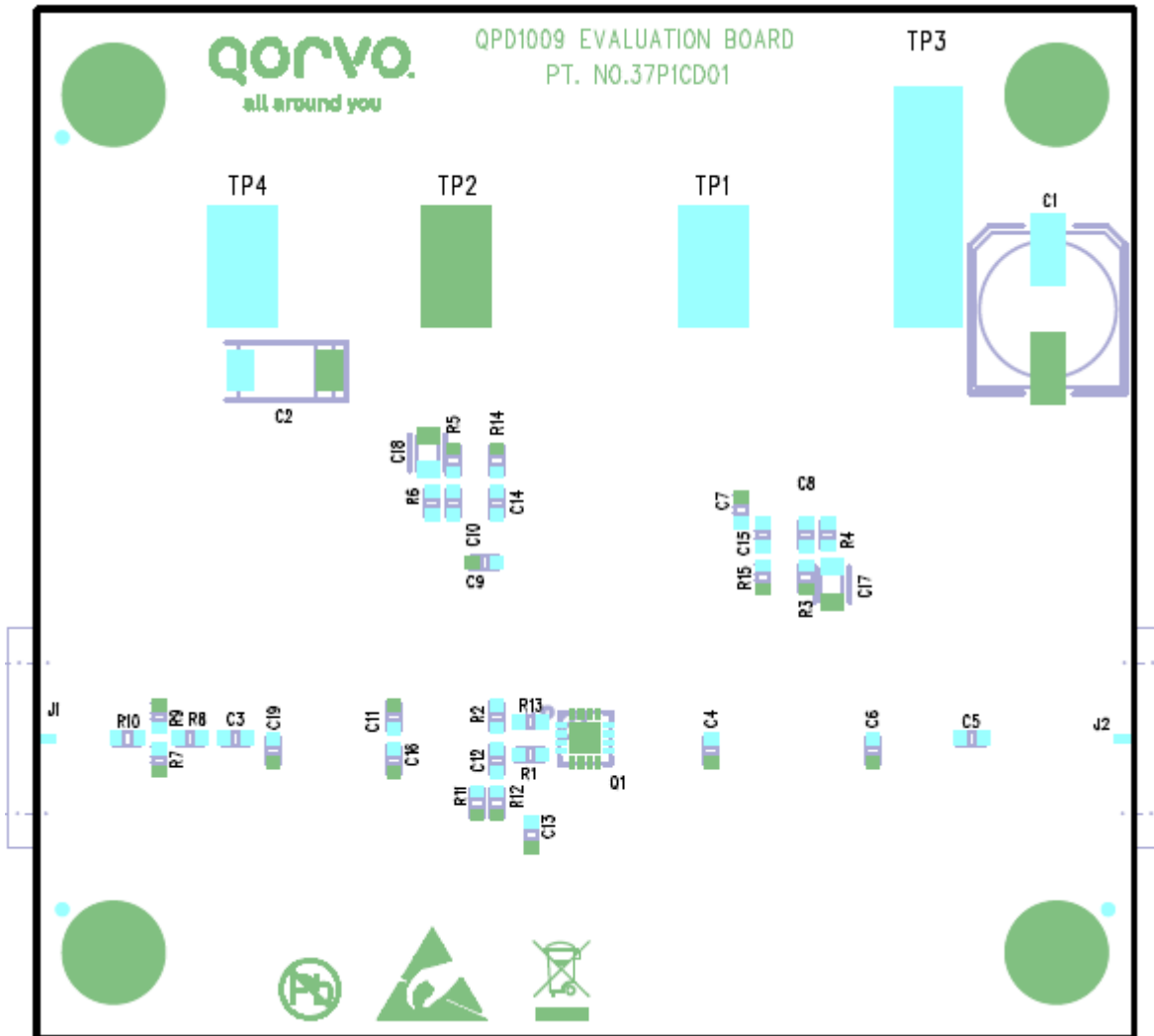

**Bill Of material - 0.96 – 1.215 GHz EVB**

Ref Des	Value	Description	Manufacturer	Part Number
C14, 15	100 pF	C0G 100V 5% 0603 Capacitor	AVX	06031A101JAT2A
C8 - 10	1 nF	X7R 100V 5% 0603 Capacitor	AVX	06031C102JAT2A
C17 - 18	100 nF	X7R 100V 5% 0805 Capacitor	AVX	08051C104JAT2A
C4	0.2 pF	RF NPO 250VDC ± 0.05 pF Capacitor	ATC	ATC600S0R2AT250X
C13	1.0 pF	RF NPO 250VDC ± 0.05 pF Capacitor	ATC	ATC600S1R0AT250X
C6	1.5 pF	RF NPO 250VDC ± 0.05 pF Capacitor	ATC	ATC600S1R5AT250X
C19	6.8 pF	RF NPO 250VDC ± 0.1 pF Capacitor	ATC	ATC600S6R8BT250X
C11, 16	7.5 pF	RF NPO 250VDC ± 0.1 pF Capacitor	ATC	ATC600S7R5BT250X
C3, 5, 7, 9, 12	56 pF	RF NPO 250VDC 1% Capacitor	ATC	ATC600S5650FT250X
C1	33 uF	80V SVP Capacitor	Panasonic	EEEFK1K330P
C2	10 uF	16V Tantalum Capacitor	AVX	TPSC106KR0500
J1 - 2		SMA Panel Mount 4-hole Jack	Gigalane	PSF-S00-000
R4, 6	1 Ohm	0603 1% Thick Film Resistor	ANY	
R1, 2, 8, 10, 13, 14, 15	5.1 Ohm	0603 1% Thick Film Resistor	ANY	
R3, 5	33 Ohm	0603 1% Thick Film Resistor	ANY	
R11, 12	150 Ohm	0603 1% Thick Film Resistor	ANY	
R7, 9	430 Ohm	0603 1% Thick Film Resistor	ANY	





## PCB Layout – 1.1 – 1.7 GHz EVB

Board material is RO4360G2 0.020" thickness with 1 oz copper cladding.

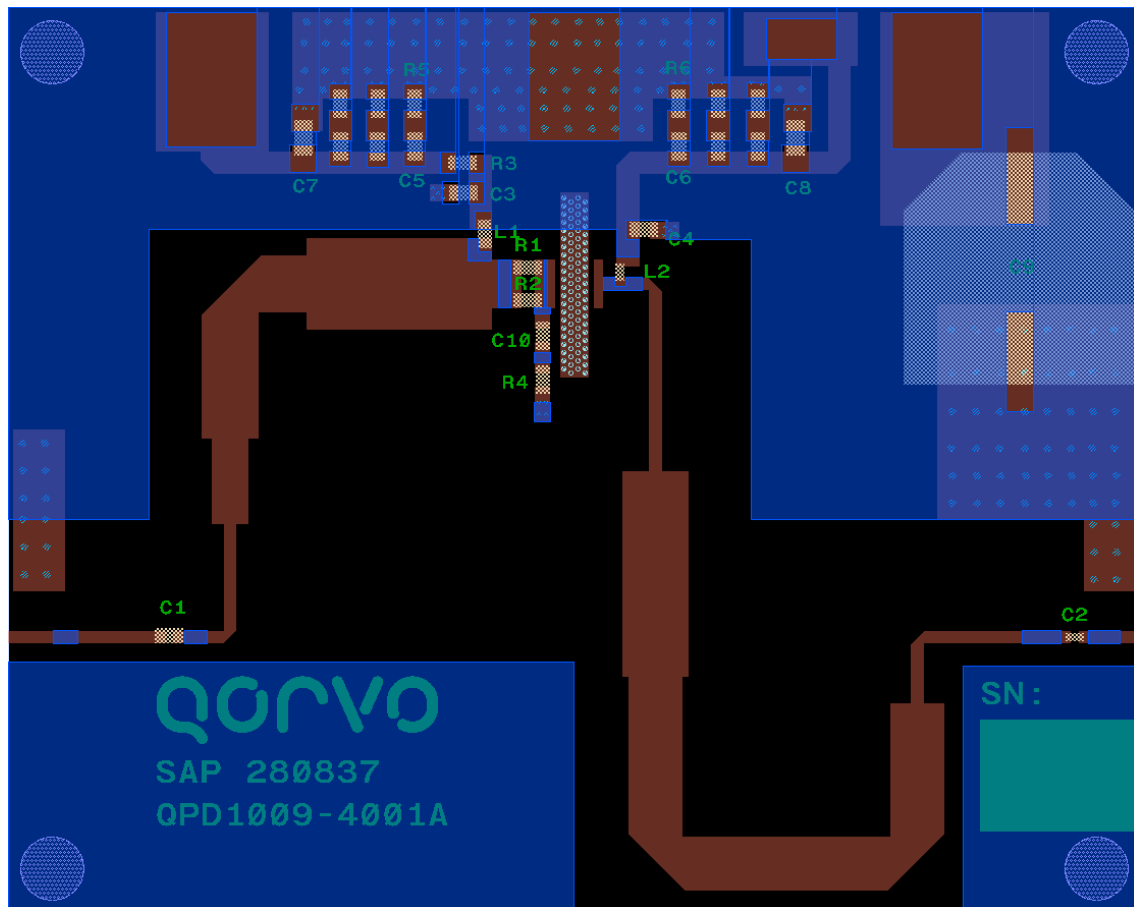

**Bill Of material – 1.1 – 1.7 GHz EVB**

Comp. Desig.	Value	Quantity	Part number	Manufacturer
C1	3.9 pF	1	600S3R9AT250XT	ATC
C2	3.3 pF	1	600S3R3AT250XT	ATC
C3, C4	22 pF	2	600S220FT250XT	ATC
C5, C6	0.01 uF	2	ECJ-2VB2A103K	Panasonic
C7	1 uF, 25 V	1	GCM21BR71E105KA56L	Murata
C8	0.1 uF, 100 V	1	08051C104JAT2A	AVX
C9	100 uF, 63 V	1	EEETG1J101UP	Panasonic
C10	1 uF, 16 V	1	GCM188R71C105KA64D	Murata
L1	5.6 nH	1	0603CS-5N6XJEW	Coilcraft
L2	5.6 nH	1	0603HP-5N6XJLW	Coilcraft
R1, R2	5.6 Ohm	2	CRCW06035R60JNEA	Vishay
R4, R5, R6	51.1 Ohm	3	CRCW060351R1FKTA	Vishay
R3	10 Ohm	1	CRCW060310R0JNTA	Vishay
PCB		1	RO4360G2, 32 mil, 1 oz copper	Rogers

**Recommended Solder Temperature Profile**

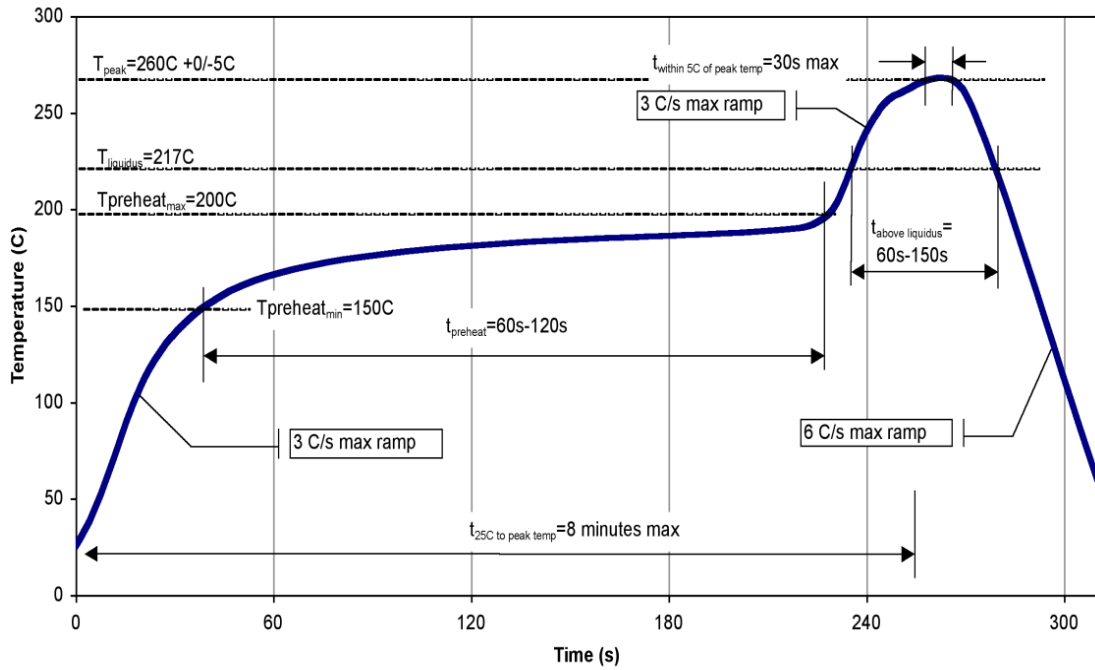

### Handling Precautions

Parameter	Rating	Standard
ESD – Human Body Model (HBM)	Class 1A	ANSI/ESD/JEDEC JS-001
ESD – Charged Device Model (CDM)	Class C2B, 1000 V	ANSI/ESD/JEDEC JS-002
MSL – Moisture Sensitivity Level	MSL3	JESD J-STD-020



Caution!  
ESD-Sensitive Device

### Solderability

Compatible with both lead-free (260°C max. reflow temp.) and tin/lead (245°C max. reflow temp.) soldering processes. Solder profiles available upon request.

Contact plating: NiPdAu

### RoHS Compliance

This part is compliant with 2011/65/EU RoHS directive (Restrictions on the Use of Certain Hazardous Substances in Electrical and Electronic Equipment) as amended by Directive 2015/863/EU.

This product also has the following attributes:

- Lead Free
- Halogen Free (Chlorine, Bromine)
- Antimony Free
- TBBP-A (C<sub>15</sub>H<sub>12</sub>Br<sub>4</sub>O<sub>2</sub>) Free
- PFOS Free
- SVHC Free

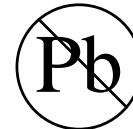

### Contact Information

For the latest specifications, additional product information, worldwide sales and distribution locations, and information about Qorvo:

Web: [www.qorvo.com](http://www.qorvo.com)      Tel: +1.844.890.8163  
 Email: [customer.support@qorvo.com](mailto:customer.support@qorvo.com)

For technical questions and application information:      Email: [info-products@qorvo.com](mailto:info-products@qorvo.com)

### Important Notice

The information contained herein is believed to be reliable; however, Qorvo makes no warranties regarding the information contained herein and assumes no responsibility or liability whatsoever for the use of the information contained herein. All information contained herein is subject to change without notice. Customers should obtain and verify the latest relevant information before placing orders for Qorvo products. The information contained herein or any use of such information does not grant, explicitly or implicitly, to any party any patent rights, licenses, or any other intellectual property rights, whether with regard to such information itself or anything described by such information. **THIS INFORMATION DOES NOT CONSTITUTE A WARRANTY WITH RESPECT TO THE PRODUCTS DESCRIBED HEREIN, AND QORVO HEREBY DISCLAIMS ANY AND ALL WARRANTIES WITH RESPECT TO SUCH PRODUCTS WHETHER EXPRESS OR IMPLIED BY LAW, COURSE OF DEALING, COURSE OF PERFORMANCE, USAGE OF TRADE OR OTHERWISE, INCLUDING THE IMPLIED WARRANTIES OF MERCHANTABILITY AND FITNESS FOR A PARTICULAR PURPOSE.**

Without limiting the generality of the foregoing, Qorvo products are not warranted or authorized for use as critical components in medical, life-saving, or life-sustaining applications, or other applications where a failure would reasonably be expected to cause severe personal injury or death.

Copyright 2016 © Qorvo, Inc. | Qorvo is a registered trademark of Qorvo, Inc.

Компания «Океан Электроники» предлагает заключение долгосрочных отношений при поставках импортных электронных компонентов на взаимовыгодных условиях!

Наши преимущества:

- Поставка оригинальных импортных электронных компонентов напрямую с производств Америки, Европы и Азии, а так же с крупнейших складов мира;
- Широкая линейка поставок активных и пассивных импортных электронных компонентов (более 30 млн. наименований);
- Поставка сложных, дефицитных, либо снятых с производства позиций;
- Оперативные сроки поставки под заказ (от 5 рабочих дней);
- Экспресс доставка в любую точку России;
- Помощь Конструкторского Отдела и консультации квалифицированных инженеров;
- Техническая поддержка проекта, помощь в подборе аналогов, поставка прототипов;
- Поставка электронных компонентов под контролем ВП;
- Система менеджмента качества сертифицирована по Международному стандарту ISO 9001;
- При необходимости вся продукция военного и аэрокосмического назначения проходит испытания и сертификацию в лаборатории (по согласованию с заказчиком);
- Поставка специализированных компонентов военного и аэрокосмического уровня качества (Xilinx, Altera, Analog Devices, Intersil, Interpoint, Microsemi, Actel, Aeroflex, Peregrine, VPT, Syfer, Eurofarad, Texas Instruments, MS Kennedy, Miteq, Cobham, E2V, MA-COM, Hittite, Mini-Circuits, General Dynamics и др.);

Компания «Океан Электроники» является официальным дистрибьютором и эксклюзивным представителем в России одного из крупнейших производителей разъемов военного и аэрокосмического назначения «JONHON», а так же официальным дистрибьютором и эксклюзивным представителем в России производителя высокотехнологичных и надежных решений для передачи СВЧ сигналов «FORSTAR».



## JONHON

«JONHON» (основан в 1970 г.)

Разъемы специального, военного и аэрокосмического назначения:

(Применяются в военной, авиационной, аэрокосмической, морской, железнодорожной, горно- и нефтедобывающей отраслях промышленности)

«FORSTAR» (основан в 1998 г.)

ВЧ соединители, коаксиальные кабели,  
кабельные сборки и микроволновые компоненты:

(Применяются в телекоммуникациях гражданского и специального назначения, в средствах связи, РЛС, а так же военной, авиационной и аэрокосмической отраслях промышленности).



Телефон: 8 (812) 309-75-97 (многоканальный)

Факс: 8 (812) 320-03-32

Электронная почта: [ocean@oceanchips.ru](mailto:ocean@oceanchips.ru)

Web: <http://oceanchips.ru/>

Адрес: 198099, г. Санкт-Петербург, ул. Калинина, д. 2, корп. 4, лит. А