

TMP type

PCB type

RoHS compliant

### FEATURES

**1. Ideal for compressor and inverter loads**

- 1) Compressor load: 20A 250V AC
- 2) Inverter load: 20A 100V AC, 10A 200V AC

**2. High insulation resistance**

- Creepage distance and clearances between contact and coil;  
Creepage Min. 9.5mm .374inch/  
Clearance Min. 8mm .315inch
- Surge withstand voltage: 10,000V

**3. "PCB" and "TMP" types available**

**4. Conforms to the various safety standards:**

UL/C-UL, TÜV and VDE approved

### TYPICAL APPLICATIONS

- Air conditioner
- Refrigerators
- OA equipment

## ORDERING INFORMATION



Note: Certified by UL/C-UL, VDE and TÜV

## TYPES

Contact arrangement	Nominal coil voltage	Part No.	
		TMP type	PCB type
1 Form A	5V DC	ALF1T05	ALF1P05
	6V DC	ALF1T06	ALF1P06
	9V DC	ALF1T09	ALF1P09
	12V DC	ALF1T12	ALF1P12
	18V DC	ALF1T18	ALF1P18
	24V DC	ALF1T24	ALF1P24

Standard packing: Carton 50 pcs., Case 200 pcs.

## RATING

### 1. Coil data

Nominal coil voltage	Pick-up voltage (at 20°C 68°F)	Drop-out voltage (at 20°C 68°F)	Nominal operating current [±10%] (at 20°C 68°F)	Coil resistance [±10%] (at 20°C 68°F)	Nominal operating power (at 20°C 68°F)	Max. applied voltage (at 20°C 68°F)
5V DC	70%V or less of nominal voltage (Initial)	10%V or more of nominal voltage (Initial)	180 mA	27.8Ω	900mW	110%V of nominal voltage
6V DC			150 mA	40 Ω		
9V DC			100 mA	90 Ω		
12V DC			75 mA	160 Ω		
18V DC			50 mA	360 Ω		
24V DC			37.5mA	640 Ω		

# LF (ALF)

## 2. Specifications

Characteristics	Item	Specifications	
Contact	Contact material	AgSnO <sub>2</sub> type	
	Arrangement	1 Form A	
	Contact resistance (Initial)	Max. 100 mΩ (By voltage drop 6 V DC 1A)	
Rating	Nominal switching capacity (resistive load)	20A 250V AC	
	Max. switching power (resistive load)	6,250VA	
	Max. switching voltage	250V AC	
	Max. switching current	25A	
	Nominal operating power	900mW	
	Min. switching capacity (reference value)*1	100mA, 5V DC	
Electrical characteristics	Insulation resistance (Initial)	Min. 1,000MΩ (at 500V DC) Measurement at same location as "Breakdown voltage" section.	
	Breakdown voltage (Initial)	Between open contacts	1,000 Vrms for 1 min. (Detection current: 10 mA)
		Between contact and coil	5,000 Vrms for 1 min. (Detection current: 10 mA)
	Temperature rise (coil)	Max. 45°C 113°F (By resistive method, nominal coil voltage applied to the coil; contact carrying current: 20A, at 60°C 140°F)	
	Surge breakdown voltage*2 (Between contact and coil) (Initial)	10,000 V	
	Operate time (at nominal voltage) (at 20°C 68°F)	Max. 20 ms (excluding contact bounce time.)	
	Release time (at nominal voltage) (at 20°C 68°F)	Max. 15 ms (excluding contact bounce time) (With diode)	
Mechanical characteristics	Shock resistance	Functional	100 m/s <sup>2</sup> (Half-wave pulse of sine wave: 11 ms; detection time: 10μs.)
		Destructive	1,000 m/s <sup>2</sup> (Half-wave pulse of sine wave: 6 ms.)
	Vibration resistance	Functional	10 to 55 Hz at double amplitude of 1.5 mm (Detection time: 10μs.)
		Destructive	10 to 55 Hz at double amplitude of 1.5 mm
Expected life	Mechanical (at 180 times/min.)	Min. 2×10 <sup>6</sup>	
	Electrical (at 20 times/min.)	Min. 10 <sup>5</sup> (resistive load)	
Conditions	Conditions for operation, transport and storage*3	Ambient temperature: -40°C to +60°C -40°F to +140°F, Humidity: 5 to 85% R.H. (Not freezing and condensing at low temperature)	
	Max. operating speed	20 times/min. (at nominal switching capacity)	
Unit weight	Approx. 23 g .81 oz		

\* Specifications will vary with foreign standards certification ratings.

Notes: \*1. This value can change due to the switching frequency, environmental conditions, and desired reliability level, therefore it is recommended to check this with the actual load.

\*2. Wave is standard shock voltage of ±1.2×50μs according to JEC-212-1981

\*3. The upper limit of the ambient temperature is the maximum temperature that can satisfy the coil temperature rise value. Refer to Usage, transport and storage conditions in NOTES.

## 3. Switching capacity

Electrical Life	Resistive load	20 A, 250 V AC (cosφ = 1)	Min. 10 <sup>5</sup> (at 20 times/min.)
		25 A, 250 V AC (cosφ = 1)	Min. 10 <sup>4</sup> (at 20 times/min.)
Compressor load	Inrush 70 A (cosφ = 0.7), Steady 20 A (cosφ = 0.9) 250 V AC	Min. 10 <sup>5</sup> (at 20 times/min.)	
		Min. 3×10 <sup>4</sup> (at 10 times/min.)	
Inverter load	Inrush 200 A, Steady 20 A 100 V AC	Min. 3×10 <sup>4</sup> (at 10 times/min.)	
		Min. 3×10 <sup>4</sup> (at 10 times/min.)	

## REFERENCE DATA

### 1. Coil temperature rise

Sample: ALF1T12, 6 pcs.

Point measured: coil inside

Contact current: 20A

Ambient temperature: 25°C 77°F, 60°C 140°F

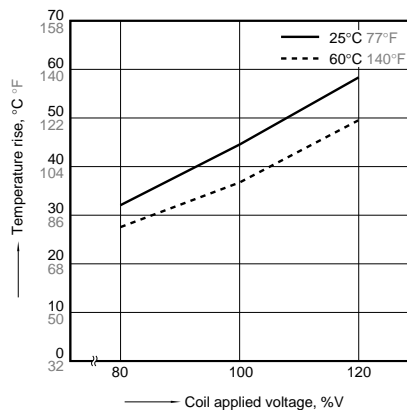

### 2-(1). 200V AC electrical life test

(200V AC, inverter load)

Sample: ALF1T12, 6 pcs.

Load: Inrush 102A (wave peak value),  
Steady 14.4A (wave peak value)

Inverter dummy 200V AC

Switching frequency: ON 1s, OFF 5s

Circuit:

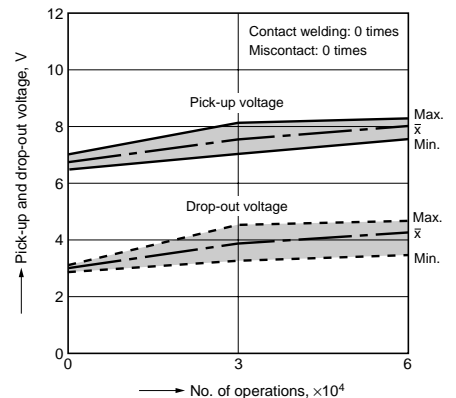
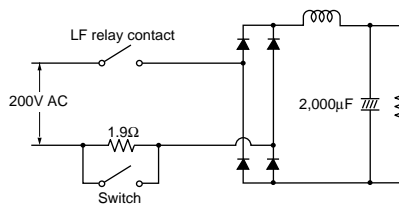

## 2-(2). 100V AC electrical life test

(100V AC, inverter load)

Sample: ALF1T12, 6 pcs.

Load: Inrush 224A (wave peak value),

Steady 30.5A (wave peak value)

Inverter dummy 100V AC

Switching frequency: ON 1s, OFF 5s

Circuit:



## 2-(3). Inrush 70.7A, Steady 20A, 250V AC electrical life test (Compressor dummy load)

Sample: ALF1T12, 3 pcs.

Load: Inrush 70.7A,  $\cos\phi = 0.7$

Steady 20A,  $\cos\phi = 0.9$

250V AC compressor dummy

Switching frequency: ON 1.5s, OFF 1.5s

Circuit:



## 2-(4). Electrical life test

(20A 250V AC, resistive load)

Sample: ALF1T12, 6 pcs.

Switching frequency: ON 1.5s, OFF 1.5s

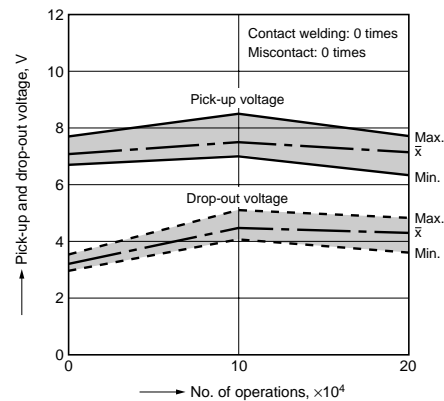

# LF (ALF)

## DIMENSIONS (mm inch)

The CAD data of the products with a **CAD Data** mark can be downloaded from: <http://industrial.panasonic.com/ac/e/>

### 1. TMP type

#### CAD Data



#### External dimensions

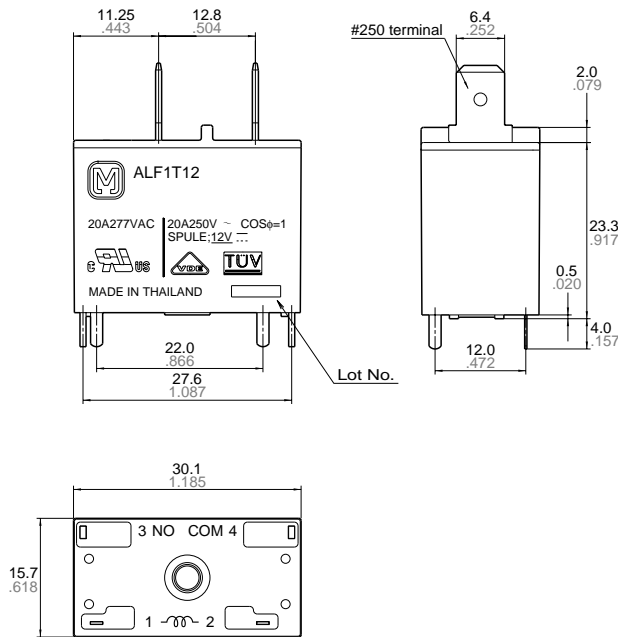

**Dimension:**  
 Less than 1mm .039inch:  
 Min. 1mm .039inch less than 3mm .118 inch:  $\pm 0.2 \pm .008$   
 Min. 3mm .118 inch:  $\pm 0.3 \pm .012$

**Tolerance**  
 $\pm 0.1 \pm .004$

#### PC board pattern (Bottom view)

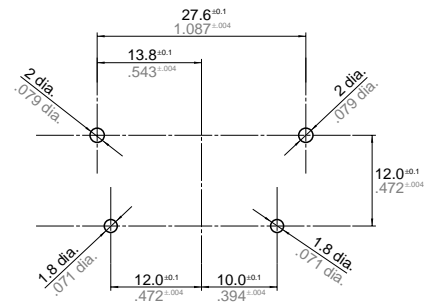

Tolerance:  $\pm 0.1 \pm .004$

#### Schematic (Bottom view)

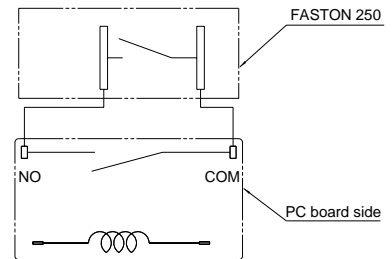

### 2. PCB type

#### CAD Data



#### External dimensions

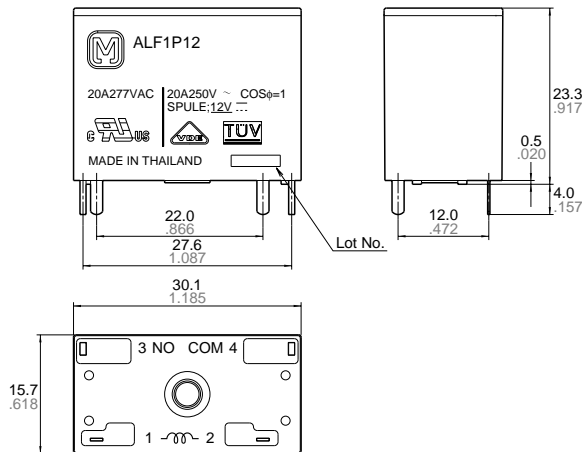

**Dimension:**  
 Less than 1mm .039inch:  
 Min. 1mm .039inch less than 3mm .118 inch:  $\pm 0.2 \pm .008$   
 Min. 3mm .118 inch:  $\pm 0.3 \pm .012$

**Tolerance**  
 $\pm 0.1 \pm .004$

#### PC board pattern (Bottom view)

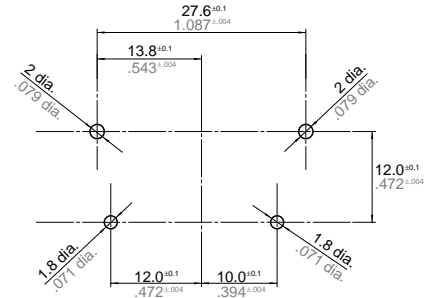

Tolerance:  $\pm 0.1 \pm .004$

#### Schematic (Bottom view)

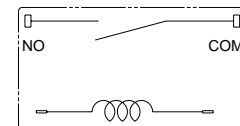

## SAFETY STANDARDS

UL/C-UL (Recognized)		VDE (Certified)		TV rating (UL/CSA)		TÜV (Certified)	
File No.	Contact rating	File No.	Contact rating	File No.	Rating	File No.	Rating
E43028	25A 277V AC 20A 277V AC	40009169	20A 250V AC (cosφ=1.0)	UL E43028	TV-8	B 11 04 13461 295	20A 250V AC (cosφ=1.0)

\* CSA standard: Certified by C-UL

## For Cautions for Use.

# Mouser Electronics

Authorized Distributor

Click to View Pricing, Inventory, Delivery & Lifecycle Information:

## Panasonic:

[ALFG1PF09](#) [ALFG1PF12](#) [ALFG1PF18](#) [ALFG1PF24](#) [ALF1M05](#) [ALF1P05](#) [ALF1P06](#) [ALF1P09](#) [ALF1P18](#)  
[ALF1P24](#) [ALF1PF12](#) [ALF1T05](#) [ALF1T06](#) [ALF1T09](#) [ALF1T18](#) [ALF1P12](#) [ALF1T24](#) [ALF1T12](#) [ALFG2PF12](#)

Компания «Океан Электроники» предлагает заключение долгосрочных отношений при поставках импортных электронных компонентов на взаимовыгодных условиях!

Наши преимущества:

- Поставка оригинальных импортных электронных компонентов напрямую с производств Америки, Европы и Азии, а так же с крупнейших складов мира;
- Широкая линейка поставок активных и пассивных импортных электронных компонентов (более 30 млн. наименований);
- Поставка сложных, дефицитных, либо снятых с производства позиций;
- Оперативные сроки поставки под заказ (от 5 рабочих дней);
- Экспресс доставка в любую точку России;
- Помощь Конструкторского Отдела и консультации квалифицированных инженеров;
- Техническая поддержка проекта, помощь в подборе аналогов, поставка прототипов;
- Поставка электронных компонентов под контролем ВП;
- Система менеджмента качества сертифицирована по Международному стандарту ISO 9001;
- При необходимости вся продукция военного и аэрокосмического назначения проходит испытания и сертификацию в лаборатории (по согласованию с заказчиком);
- Поставка специализированных компонентов военного и аэрокосмического уровня качества (Xilinx, Altera, Analog Devices, Intersil, Interpoint, Microsemi, Actel, Aeroflex, Peregrine, VPT, Syfer, Eurofarad, Texas Instruments, MS Kennedy, Miteq, Cobham, E2V, MA-COM, Hittite, Mini-Circuits, General Dynamics и др.);

Компания «Океан Электроники» является официальным дистрибьютором и эксклюзивным представителем в России одного из крупнейших производителей разъемов военного и аэрокосмического назначения «JONHON», а так же официальным дистрибьютором и эксклюзивным представителем в России производителя высокотехнологичных и надежных решений для передачи СВЧ сигналов «FORSTAR».



## JONHON

«JONHON» (основан в 1970 г.)

Разъемы специального, военного и аэрокосмического назначения:

(Применяются в военной, авиационной, аэрокосмической, морской, железнодорожной, горно- и нефтедобывающей отраслях промышленности)

«FORSTAR» (основан в 1998 г.)

ВЧ соединители, коаксиальные кабели, кабельные сборки и микроволновые компоненты:

(Применяются в телекоммуникациях гражданского и специального назначения, в средствах связи, РЛС, а так же военной, авиационной и аэрокосмической отраслях промышленности).



Телефон: 8 (812) 309-75-97 (многоканальный)

Факс: 8 (812) 320-03-32

Электронная почта: [ocean@oceanchips.ru](mailto:ocean@oceanchips.ru)

Web: <http://oceanchips.ru/>

Адрес: 198099, г. Санкт-Петербург, ул. Калинина, д. 2, корп. 4, лит. А